

ROBOTICS

Technical reference manual

RAPID Instructions, Functions and Data types



Trace back information:
Workspace 24A version a10
Checked in 2024-03-04
Skribenta version 5.5.019

Technical reference manual
RAPID Instructions, Functions and Data types

RobotWare 6.15.06

Document ID: 3HAC050917-001

Revision: V

The information in this manual is subject to change without notice and should not be construed as a commitment by ABB. ABB assumes no responsibility for any errors that may appear in this manual.

Except as may be expressly stated anywhere in this manual, nothing herein shall be construed as any kind of guarantee or warranty by ABB for losses, damage to persons or property, fitness for a specific purpose or the like.

In no event shall ABB be liable for incidental or consequential damages arising from use of this manual and products described herein.

This manual and parts thereof must not be reproduced or copied without ABB's written permission.

Keep for future reference.

Additional copies of this manual may be obtained from ABB.

Original instructions.

© Copyright 2004-2024 ABB. All rights reserved.
Specifications subject to change without notice.

Table of contents

Overview of this manual	19
1 Instructions	25
1.1 AccSet - Reduces the acceleration	25
1.2 ActEventBuffer - Activation of event buffer	28
1.3 ActUnit - Activates a mechanical unit	30
1.4 Add - Adds a numeric value	32
1.5 AliasCamera - Define camera device with alias name	34
1.6 AliasIO - Define I/O signal with alias name	36
1.7 AliasIOReset - Resetting I/O signal with alias name	39
1.8 ":= " - Assigns a value	41
1.9 BitClear - Clear a specified bit in a byte or dnum data	43
1.10 BitSet - Set a specified bit in a byte or dnum data	46
1.11 BookErrNo - Book a RAPID system error number	49
1.12 Break - Break program execution	51
1.13 CallByVar - Call a procedure by a variable	52
1.14 CamFlush - Removes the collection data for the camera	54
1.15 CamGetParameter - Get different named camera parameters	55
1.16 CamGetResult - Gets a camera target from the collection	57
1.17 CamLoadJob - Load a camera task into a camera	59
1.18 CamReqlImage - Order the camera to acquire an image	61
1.19 CamSetExposure - Set camera specific data	63
1.20 CamSetParameter - Set different named camera parameters	65
1.21 CamSetProgramMode - Orders the camera to go to program mode	67
1.22 CamSetRunMode - Orders the camera to run mode	68
1.23 CamStartLoadJob - Start load of a camera task into a camera	69
1.24 CamStartSetParameter - Start the set-operation of a parameter setting	71
1.25 CamWaitLoadJob - Wait until a camera task is loaded	74
1.26 CamWaitSetParameter - Wait until a set-operation is ready	76
1.27 CancelLoad - Cancel loading of a module	78
1.28 CapAPTrSetup - Set up an At-Point-Tracker	80
1.29 CapAPTrSetupAI - Setup an At-Point-Tracker controlled by analog input signals	83
1.30 CapAPTrSetupAO - Setup an At-Point-Tracker controlled by analog output signals	86
1.31 CapAPTrSetupPERS - Setup an At-Point-Tracker controlled by persistent variables	89
1.32 CapC - Circular CAP movement instruction	92
1.33 CapCondSetDO - Set a digital output signal at TCP stop	103
1.34 CapEquiDist - Generate equidistant event	105
1.35 CapL - Linear CAP movement instruction	107
1.36 CapLATrSetup - Set up a Look-Ahead-Tracker	117
1.37 CapNoProcess - Run CAP without process	122
1.38 CapRefresh - Refresh CAP data	124
1.39 CAPSetStopMode - Set the stop mode for execution errors	126
1.40 CapWeaveSync - set up signals and levels for weave synchronization	127
1.41 CheckProgRef - Check program references	130
1.42 CirPathMode - Tool reorientation during circle path	132
1.43 Clear - Clears the value	138
1.44 ClearIOBuff - Clear input buffer of a serial channel	139
1.45 ClearPath - Clear current path	141
1.46 ClearRawBytes - Clear the contents of rawbytes data	145
1.47 ClkReset - Resets a clock used for timing	147
1.48 ClkStart - Starts a clock used for timing	148
1.49 ClkStop - Stops a clock used for timing	150
1.50 Close - Closes a file or I/O device	151
1.51 CloseDir - Close a directory	152
1.52 Comment - Comment	153
1.53 Compact IF - If a condition is met, then... (one instruction)	154
1.54 ConfJ - Controls the configuration during joint movement	155

1.55	ConfL - Monitors the configuration during linear movement	157
1.56	CONNECT - Connects an interrupt to a trap routine	160
1.57	ContactL - Linear contact movement	162
1.58	CopyFile - Copy a file	167
1.59	CopyRawBytes - Copy the contents of rawbytes data	169
1.60	CornerPathWarning - Show or hide corner path warnings	171
1.61	CorrClear - Removes all correction generators	173
1.62	CorrCon - Connects to a correction generator	174
1.63	CorrDiscon - Disconnects from a correction generator	179
1.64	CorrWrite - Writes to a correction generator	180
1.65	DeactEventBuffer - Deactivation of event buffer	182
1.66	DeactUnit - Deactivates a mechanical unit	184
1.67	Decr - Decrements by 1	186
1.68	DropSensor - Drop object on sensor	188
1.69	DropWObj - Drop work object on conveyor	189
1.70	EOffsOff - Deactivates an offset for additional axes	190
1.71	EOffsOn - Activates an offset for additional axes	191
1.72	EOffsSet - Activates an offset for additional axes using known values	193
1.73	EraseModule - Erase a module	195
1.74	ErrLog - Write an error message	197
1.75	ErrRaise - Writes a warning and calls an error handler	201
1.76	ErrWrite - Write an error message	205
1.77	EXIT - Terminates program execution	207
1.78	ExitCycle - Break current cycle and start next	208
1.79	FitCircle - Fits a circle to 3D-points	210
1.80	FitLine - Fits a line to a set of points	214
1.81	FitPlane - Fits a plane to a set of points	216
1.82	FitSphere - Fit a sphere to a set of points	218
1.83	FOR - Repeats a given number of times	220
1.84	FricIdInit - Initiate friction identification	223
1.85	FricIdEvaluate - Evaluate friction identification	224
1.86	FricIdSetFricLevels - Set friction levels after friction identification	227
1.87	GetDataVal - Get the value of a data object	229
1.88	GetGroupSignalInfo - Read information about a digital group signal	232
1.89	GetJointData - Get joint specific data	234
1.90	GetSysData - Get system data	236
1.91	GetTrapData - Get interrupt data for current trap routine	239
1.92	GOTO - Goes to a new instruction	241
1.93	GripLoad - Defines the payload for a robot	243
1.94	HollowWristReset - Reset hollow wrist	245
1.95	ICap - connect CAP events to trap routines	247
1.96	IDelete - Cancels an interrupt	252
1.97	IDisable - Disables interrupts	253
1.98	IEnable - Enables interrupts	254
1.99	IError - Orders an interrupt on errors	255
1.100	IF - If a condition is met, then ...; otherwise	258
1.101	Incr - Increments by 1	260
1.102	IndAMove - Independent absolute position movement	262
1.103	IndCMove - Independent continuous movement	266
1.104	IndDMove - Independent delta position movement	270
1.105	IndReset - Independent reset	273
1.106	IndRMove - Independent relative position movement	278
1.107	InitSuperv - Reset all supervision for CAP	282
1.108	InvertDO - Inverts the value of a digital output signal	283
1.109	IOBusStart - Start of I/O network	285
1.110	IOBusState - Get current state of I/O network	286
1.111	IODisable - Deactivate an I/O device	289
1.112	IOEnable - Activate an I/O device	292
1.113	IOEventMessage - Turn on/off I/O event messages from device	295

1.114	IPathPos - Get center line robtarget when weaving	297
1.115	IPers - Interrupt at value change of a persistent variable	299
1.116	IRMQMessage - Orders RMQ interrupts for a data type	301
1.117	ISignalAI - Interrupts from analog input signal	305
1.118	ISignalAO - Interrupts from analog output signal	315
1.119	ISignalDI - Orders interrupts from a digital input signal	319
1.120	ISignalDO - Interrupts from a digital output signal	322
1.121	ISignalGI - Orders interrupts from a group of digital input signals	325
1.122	ISignalGO - Orders interrupts from a group of digital output signals	328
1.123	ISleep - Deactivates an interrupt	331
1.124	ITimer - Orders a timed interrupt	333
1.125	IVarValue - orders a variable value interrupt	336
1.126	IWatch - Activates an interrupt	339
1.127	Label - Line name	341
1.128	Load - Load a program module during execution	342
1.129	LoadId - Load identification of tool or payload	347
1.130	MakeDir - Create a new directory	353
1.131	ManLoadIdProc - Load identification of IRBP manipulators	354
1.132	MatrixAdd - Calculates the sum of two matrices	358
1.133	MatrixInverse - Inverse a matrix	361
1.134	MatrixMult - Multiply two matrices or multiply matrix with scalar	364
1.135	MatrixReset - Set all elements in a matrix to 0	369
1.136	MatrixSolve - Solve a linear equation system	371
1.137	MatrixSolveQR - Computes a QR-factorization	374
1.138	MatrixSub - Calculates the difference between two matrices	376
1.139	MatrixSVD - Computes a singular value decomposition	379
1.140	MatrixTranspose - Transpose a matrix	382
1.141	MechUnitLoad - Defines a payload for a mechanical unit	385
1.142	MotionProcessModeSet - Set motion process mode	390
1.143	MotionSup - Deactivates/Activates motion supervision	392
1.144	MoveAbsJ - Moves the robot to an absolute joint position	395
1.145	MoveC - Moves the robot circularly	402
1.146	MoveCAO - Moves the robot circularly and sets analog output in the corner	410
1.147	MoveCDO - Moves the robot circularly and sets digital output in the corner	415
1.148	MoveCGO - Moves the robot circularly and set a group output signal in the corner	420
1.149	MoveCSync - Moves the robot circularly and executes a RAPID procedure	425
1.150	MoveExtJ - Move one or several mechanical units without TCP	430
1.151	MoveJ - Moves the robot by joint movement	434
1.152	MoveJAO - Moves the robot by joint movement and sets analog output in the corner	439
1.153	MoveJDO - Moves the robot by joint movement and sets digital output in the corner	444
1.154	MoveJGO - Moves the robot by joint movement and set a group output signal in the corner	448
1.155	MoveJSync - Moves the robot by joint movement and executes a RAPID procedure	453
1.156	MoveL - Moves the robot linearly	458
1.157	MoveLAO - Moves the robot linearly and sets analog output in the corner	464
1.158	MoveLDO - Moves the robot linearly and sets digital output in the corner	469
1.159	MoveLGO - Moves the robot linearly and sets group output signal in the corner	473
1.160	MoveLSync - Moves the robot linearly and executes a RAPID procedure	478
1.161	MovePnP - Moves the robot along a pick and place path	483
1.162	MToolRotCalib - Calibration of rotation for moving tool	493
1.163	MToolTCPCalib - Calibration of TCP for moving tool	496
1.164	Open - Opens a file or I/O device	499
1.165	OpenDir - Open a directory	503
1.166	PackDNHeader - Pack DeviceNet Header into rawbytes data	505
1.167	PackRawBytes - Pack data into rawbytes data	508
1.168	PathAccLim - Reduce TCP acceleration along the path	512
1.169	PathLengthReset - Resets the current path-length value of the counter	516
1.170	PathLengthStart - Activates the counter that monitors the path-length	518
1.171	PathLengthStop - Stops the counter that monitors the path-length	520

1.172	PathRecMoveBwd - Move path recorder backwards	522
1.173	PathRecMoveFwd - Move path recorder forward	528
1.174	PathRecStart - Start the path recorder	531
1.175	PathRecStop - Stop the path recorder	534
1.176	PathResol - Override path resolution	537
1.177	PDispOff - Deactivates program displacement	539
1.178	PDispOn - Activates program displacement	540
1.179	PDispSet - Activates program displacement using known frame	545
1.180	ProcCall - Calls a new procedure	548
1.181	ProcerrRecovery - Generate and recover from process-move error	550
1.182	PrxActivAndStoreRecord - Activate and store the recorded profile data	556
1.183	PrxActivRecord - Activate the recorded profile data	558
1.184	PrxDbgStoreRecord - Store and debug the recorded profile data	560
1.185	PrxDeactRecord - Deactivate a record	561
1.186	PrxResetPos - Reset the zero position of the sensor	562
1.187	PrxResetRecords - Reset and deactivate all records	563
1.188	PrxSetPosOffset - Set a reference position for the sensor	564
1.189	PrxSetRecordSampleTime - Set the sample time for recording a profile	565
1.190	PrxSetSyncalarm - Set sync alarm behavior	566
1.191	PrxStartRecord - Record a new profile	567
1.192	PrxStopRecord - Stop recording a profile	569
1.193	PrxStoreRecord - Store the recorded profile data	570
1.194	PrxUseFileRecord - Use the recorded profile data	572
1.195	PulseDO - Generates a pulse on a digital output signal	573
1.196	RAISE - Calls an error handler	576
1.197	RaiseToUser - Propagates an error to user level	579
1.198	ReadAnyBin - Read data from a binary I/O device or file	582
1.199	ReadBlock - read a block of data from device	584
1.200	ReadCfgData - Reads attribute of a system parameter	586
1.201	ReadErrData - Gets information about an error	590
1.202	ReadRawBytes - Read rawbytes data	593
1.203	ReadVarArr - Read multiple variables from a sensor device	596
1.204	RemoveAllCyclicBool - Remove all Cyclic bool conditions	598
1.205	RemoveCyclicBool - Remove a Cyclic bool condition	600
1.206	RemoveDir - Delete a directory	602
1.207	RemoveFile - Delete a file	604
1.208	RemoveSuperv - Remove condition for one signal	605
1.209	RenameFile - Rename a file	607
1.210	Reset - Resets a digital output signal	609
1.211	ResetAxisDistance - Reset the traversed distance information for the axis	611
1.212	ResetAxisMoveTime - Reset the move time counter of the axis	613
1.213	ResetPPMoved - Reset state for the program pointer moved in manual mode	615
1.214	ResetRetryCount - Reset the number of retries	616
1.215	ResetTorqueMargin - Reset least torque margin	617
1.216	RestoPath - Restores the path after an interrupt	618
1.217	RETRY - Resume execution after an error	620
1.218	RETURN - Finishes execution of a routine	621
1.219	Rewind - Rewind file position	623
1.220	RMQEmptyQueue - Empty RAPID Message Queue	624
1.221	RMQFindSlot - Find a slot identity from the slot name	626
1.222	RMQGetMessage - Get an RMQ message	628
1.223	RMQGetMsgData - Get the data part from an RMQ message	631
1.224	RMQGetMsgHeader - Get header information from an RMQ message	634
1.225	RMQReadWait - Returns message from RMQ	637
1.226	RMQSendMessage - Send an RMQ data message	640
1.227	RMQSendWait - Send an RMQ data message and wait for a response	644
1.228	SafetyControllerSyncRequest - Initiation of hardware synchronization procedure	649
1.229	Save - Save a program module	650
1.230	SaveCfgData - Save system parameters to file	653

1.231	SCWrite - Send variable data to a client application	655
1.232	SearchC - Searches circularly using the robot	658
1.233	SearchExtJ - Search with one or several mechanical units without TCP	668
1.234	SearchL - Searches linearly using the robot	676
1.235	SenDevice - connect to a sensor device	688
1.236	Set - Sets a digital output signal	690
1.237	SetAllDataVal - Set a value to all data objects in a defined set	692
1.238	SetAO - Changes the value of an analog output signal	694
1.239	SetDataSearch - Define the symbol set in a search sequence	696
1.240	SetDataVal - Set the value of a data object	701
1.241	SetDO - Changes the value of a digital output signal	704
1.242	SetGO - Changes the value of a group of digital output signals	707
1.243	SetLeadThrough - Activate and deactivate lead-through	710
1.244	SetSysData - Set system data	713
1.245	SetupCyclicBool - Setup a Cyclic bool condition	715
1.246	SetupSuperv - Setup conditions for signal supervision in CAP	718
1.247	SiConnect - Sensor Interface Connect	721
1.248	SiClose - Sensor Interface Close	724
1.249	SiGetCyclic - Sensor Interface Get Cyclic	726
1.250	SimCollision - Simulate a collision	728
1.251	SingArea - Defines interpolation around singular points	729
1.252	SiSetCyclic - Sensor Interface Set Cyclic	732
1.253	SkipWarn - Skip the latest warning	734
1.254	SocketAccept - Accept an incoming connection	735
1.255	SocketBind - Bind a socket to my IP-address and port	738
1.256	SocketClose - Close a socket	740
1.257	SocketConnect - Connect to a remote computer	742
1.258	SocketCreate - Create a new socket	745
1.259	SocketListen - Listen for incoming connections	747
1.260	SocketReceive - Receive data from remote computer	749
1.261	SocketReceiveFrom - Receive data from remote computer	754
1.262	SocketSend - Send data to remote computer	759
1.263	SocketSendTo - Send data to remote computer	763
1.264	SoftAct - Activating the soft servo	767
1.265	SoftDeact - Deactivating the soft servo	769
1.266	SoftElbow - Making the elbow flexible for external forces	770
1.267	SpeedLimAxis - Set speed limitation for an axis	772
1.268	SpeedLimCheckPoint - Set speed limitation for check points	776
1.269	SpeedRefresh - Update speed override for ongoing movement	781
1.270	SpyStart - Start recording of execution time data	784
1.271	SpyStop - Stop recording of time execution data	786
1.272	StartLoad - Load a program module during execution	787
1.273	StartMove - Restarts robot movement	791
1.274	StartMoveRetry - Restarts robot movement and execution	794
1.275	STCalib - Calibrate a Servo Tool	797
1.276	STClose - Close a Servo Tool	801
1.277	StepBwdPath - Move backwards one step on path	804
1.278	STIndGun - Sets the servo tool in independent mode	806
1.279	STIndGunReset - Resets the servo tool from independent mode	808
1.280	SToolRotCalib - Calibration of TCP and rotation for stationary tool	809
1.281	SToolTCPCalib - Calibration of TCP for stationary tool	812
1.282	Stop - Stops program execution	815
1.283	STOpen - Open a Servo Tool	818
1.284	StopMove - Stops robot movement	820
1.285	StopMoveReset - Reset the system stop move state	824
1.286	StorePath - Stores the path when an interrupt occurs	826
1.287	STTune - Tuning Servo Tool	828
1.288	STTuneReset - Resetting Servo tool tuning	832
1.289	SupSyncSensorOff - Stop synchronized sensor supervision	833

1.290	SupSyncSensorOn - Start synchronized sensor supervision	834
1.291	SyncMoveOff - End coordinated synchronized movements	836
1.292	SyncMoveOn - Start coordinated synchronized movements	842
1.293	SyncMoveResume - Set synchronized coordinated movements	848
1.294	SyncMoveSuspend - Set independent-semicoordinated movements	850
1.295	SyncMoveUndo - Set independent movements	852
1.296	SyncToSensor - Sync to sensor	854
1.297	SystemStopAction - Stop the robot system	856
1.298	TEST - Depending on the value of an expression	858
1.299	TestSignDefine - Define test signal	860
1.300	TestSignReset - Reset all test signal definitions	862
1.301	TextTablInstall - Installing a text table	863
1.302	TPErase - Erases text printed on the FlexPendant	865
1.303	TPReadDnum - Reads a number from the FlexPendant	866
1.304	TPReadFK - Reads function keys	870
1.305	TPReadNum - Reads a number from the FlexPendant	875
1.306	TPShow - Switch window on the FlexPendant	879
1.307	TPWrite - Writes on the FlexPendant	880
1.308	TriggAbsJ - Absolute joint robot movements with events	883
1.309	TriggC - Circular robot movement with events	891
1.310	TriggCheckIO - Defines I/O check at a fixed position	900
1.311	TriggDataCopy - Copy the content in a triggdata variable	906
1.312	TriggDataReset - Reset the content in a triggdata variable	908
1.313	TriggEquip - Define a fixed position and time I/O event on the path	910
1.314	TriggInt - Defines a position related interrupt	916
1.315	TriggIO - Define a fixed position or time I/O event near a stop point	921
1.316	TriggJ - Axis-wise robot movements with events	927
1.317	TriggL - Linear robot movements with events	935
1.318	TriggJIOs - Joint robot movements with I/O events	943
1.319	TriggLIOs - Linear robot movements with I/O events	950
1.320	TriggRampAO - Define a fixed position ramp AO event on the path	958
1.321	TriggSpeed - Defines TCP speed proportional analog output with fixed position-time scale event	965
1.322	TriggStopProc - Generate restart data for trigg signals at stop	975
1.323	TryInt - Test if data object is a valid integer	981
1.324	TRYNEXT - Jumps over an instruction which has caused an error	983
1.325	TuneReset - Resetting servo tuning	984
1.326	TuneServo - Tuning servos	985
1.327	UIMsgBox - User Message Dialog Box type basic	992
1.328	UIMsgWrite - User message dialog box type non-waiting	1001
1.329	UIMsgWriteAbort - Abort user message dialog box type non-waiting	1005
1.330	UIShow - User Interface show	1006
1.331	UnLoad - Unload a program module during execution	1010
1.332	UnpackRawBytes - Unpack data from rawbytes data	1013
1.333	VelSet - Changes the programmed velocity	1017
1.334	WaitAI - Waits until an analog input signal value is set	1019
1.335	WaitAO - Waits until an analog output signal value is set	1026
1.336	WaitDI - Waits until a digital input signal is set	1033
1.337	WaitDO - Waits until a digital output signal is set	1039
1.338	WaitGI - Waits until a group of digital input signals are set	1045
1.339	WaitGO - Waits until a group of digital output signals are set	1053
1.340	WaitLoad - Connect the loaded module to the task	1061
1.341	WaitRob - Wait until stop point or zero speed	1065
1.342	WaitSensor - Wait for connection on sensor	1067
1.343	WaitSyncTask - Wait at synchronization point for other program tasks	1070
1.344	WaitTestAndSet - Wait until variable becomes FALSE, then set	1074
1.345	WaitTime - Waits a given amount of time	1077
1.346	WaitUntil - Waits until a condition is met	1079
1.347	WaitWObj - Wait for work object on conveyor	1087

1.348	WarmStart - Restart the controller	1090
1.349	WHILE - Repeats as long as	1091
1.350	WorldAccLim - Control acceleration in world coordinate system	1093
1.351	Write - Writes to a character-based file or I/O device	1095
1.352	WriteAnyBin - Writes data to a binary file or I/O device	1098
1.353	WriteBin - Writes to a binary I/O device	1100
1.354	WriteBlock - Write block of data to device	1102
1.355	WriteCfgData - Writes attribute of a system parameter	1104
1.356	WriteRawBytes - Write rawbytes data	1108
1.357	WriteStrBin - Writes a string to a binary I/O device	1110
1.358	WriteVar - Write variable	1112
1.359	WriteVarArr - Write multiple variables to a sensor device	1114
1.360	WZBoxDef - Define a box-shaped world zone	1116
1.361	WZCylDef - Define a cylinder-shaped world zone	1118
1.362	WZDisable - Deactivate temporary world zone supervision	1121
1.363	WZDOSet - Activate world zone to set digital output	1123
1.364	WZEnable - Activate temporary world zone supervision	1127
1.365	WZFree - Erase temporary world zone supervision	1129
1.366	WZHomeJointDef - Define a world zone for home joints	1131
1.367	WZLimJointDef - Define a world zone for limitation in joints	1134
1.368	WZLimSup - Activate world zone limit supervision	1138
1.369	WZSphDef - Define a sphere-shaped world zone	1141
2	Functions	1143
2.1	Abs - Gets the absolute value	1143
2.2	AbsDnum - Gets the absolute value of a dnum	1145
2.3	ACos - Calculates the arc cosine value	1147
2.4	ACosDnum - Calculates the arc cosine value	1148
2.5	AINput - Reads the value of an analog input signal	1149
2.6	AND - Evaluates a logical value	1151
2.7	AOutput - Reads the value of an analog output signal	1153
2.8	ArgName - Gets argument name	1155
2.9	ASin - Calculates the arc sine value	1158
2.10	ASinDnum - Calculates the arc sine value	1159
2.11	ATan - Calculates the arc tangent value	1160
2.12	ATanDnum - Calculates the arc tangent value	1161
2.13	ATan2 - Calculates the arc tangent2 value	1162
2.14	ATan2Dnum - Calculates the arc tangent2 value	1163
2.15	BitAnd - Logical bitwise AND - operation on byte data	1164
2.16	BitAndDnum - Logical bitwise AND - operation on dnum data	1166
2.17	BitCheck - Check if a specified bit in a byte data is set	1168
2.18	BitCheckDnum - Check if a specified bit in a dnum data is set	1170
2.19	BitLSh - Logical bitwise LEFT SHIFT - operation on byte	1172
2.20	BitLShDnum - Logical bitwise LEFT SHIFT - operation on dnum	1174
2.21	BitNeg - Logical bitwise NEGATION - operation on byte data	1176
2.22	BitNegDnum - Logical bitwise NEGATION - operation on dnum data	1178
2.23	BitOr - Logical bitwise OR - operation on byte data	1180
2.24	BitOrDnum - Logical bitwise OR - operation on dnum data	1182
2.25	BitRSh - Logical bitwise RIGHT SHIFT - operation on byte	1184
2.26	BitRShDnum - Logical bitwise RIGHT SHIFT - operation on dnum	1186
2.27	BitXor - Logical bitwise XOR - operation on byte data	1188
2.28	BitXorDnum - Logical bitwise XOR - operation on dnum data	1190
2.29	ByteToStr - Converts a byte to a string data	1192
2.30	CalcJointT - Calculates joint angles from robtargt	1194
2.31	CalcRobT - Calculates robtargt from jointtargt	1198
2.32	CalcRotAxFrameZ - Calculate a rotational axis frame	1200
2.33	CalcRotAxisFrame - Calculate a rotational axis frame	1205
2.34	CamGetExposure - Get camera specific data	1209
2.35	CamGetLoadedJob - Get name of the loaded camera task	1211

2.36	CamGetMode - Get current mode of camera	1213
2.37	CamGetName - Get the name of the used camera	1214
2.38	CamNumberOfResults - Get number of available results	1215
2.39	CapGetFailSigs - Get failed I/O signals	1217
2.40	CDate - Reads the current date as a string	1219
2.41	CJointT - Reads the current joint angles	1220
2.42	ClkRead - Reads a clock used for timing	1222
2.43	CorrRead - Reads the current total offsets	1224
2.44	Cos - Calculates the cosine value	1225
2.45	CosDnum - Calculates the cosine value	1226
2.46	CPos - Reads the current position (pos) data	1227
2.47	CRobT - Reads the current position (robtarg) data	1229
2.48	CrossProd - Cross product of two pos vectors	1232
2.49	CSpeedOverride - Reads the current override speed	1235
2.50	CTime - Reads the current time as a string	1237
2.51	CTool - Reads the current tool data	1238
2.52	CWObj - Reads the current work object data	1240
2.53	DecToHex - Convert from decimal to hexadecimal	1242
2.54	DefAccFrame - Define an accurate frame	1243
2.55	DefDFrame - Define a displacement frame	1246
2.56	DefFrame - Define a frame	1249
2.57	Dim - Obtains the size of an array	1252
2.58	DInput - Reads the value of a digital input signal	1254
2.59	Distance - Distance between two points	1256
2.60	DIV - Evaluates an integer division	1258
2.61	DnumToNum - Converts dnum to num	1259
2.62	DnumToStr - Converts numeric value to string	1261
2.63	DotProd - Dot product of two pos vectors	1263
2.64	DOutput - Reads the value of a digital output signal	1265
2.65	EulerZYX - Gets euler angles from orient	1267
2.66	EventType - Get current event type inside any event routine	1269
2.67	ExecHandler - Get type of execution handler	1271
2.68	ExecLevel - Get execution level	1272
2.69	Exp - Calculates the exponential value	1273
2.70	FileSize - Retrieve the size of a file	1274
2.71	FileTimeDnum - Retrieve time information about a file	1277
2.72	FSSize - Retrieve the size of a file system	1280
2.73	GetAxisDistance - Get the traversed distance counter of the axis	1283
2.74	GetAxisMoveTime - Get the move time counter of the axis	1285
2.75	GetMaxNumberOfCyclicBool - Get the maximum number of Cyclic bool conditions	1287
2.76	GetMecUnitName - Get the name of the mechanical unit	1288
2.77	GetModalPayLoadMode - Get the ModalPayLoadMode value	1289
2.78	GetMotorTorque - Reads the current motor torque	1290
2.79	GetNextCyclicBool - Get the names of all Cyclic bools	1293
2.80	GetNextMechUnit - Get name and data for mechanical units	1295
2.81	GetNextOption - Get name of options installed	1298
2.82	GetNextSym - Get next matching symbol	1299
2.83	GetNumberOfCyclicBool - Get the number of Cyclic bool conditions	1301
2.84	GetServiceInfo - Get service information from the system	1302
2.85	GetSignalOrigin - Get information about the origin of an I/O signal	1304
2.86	GetSysInfo - Get information about the system	1306
2.87	GetTaskName - Gets the name and number of current task	1309
2.88	GetTime - Reads the current time as a numeric value	1311
2.89	GetTorqueMargin - Reads the least torque margin	1313
2.90	GetTSPStatus - Get current task selection panel status	1315
2.91	GetUASUserName - Get user name of logged in user	1317
2.92	GInput - Read value of group input signal	1319
2.93	GInputDnum - Read value of group input signal	1321
2.94	GOutput - Reads the value of a group of digital output signals	1324

2.95	GOutputDnum - Read value of group output signal	1326
2.96	HexToDec - Convert from hexadecimal to decimal	1329
2.97	IndInpos - Independent axis in position status	1330
2.98	IndSpeed - Independent speed status	1332
2.99	IUnitState - Get current state of I/O device	1334
2.100	IsBrakeCheckActive - Test if brake check is running	1337
2.101	IsCollFree - Checks if position would collide	1338
2.102	IsCyclicBool - Checks if a persistent variable is a Cyclic bool	1340
2.103	IsFile - Check the type of a file	1343
2.104	IsLeadThrough - Check lead-through status	1347
2.105	IsMechUnitActive - Is mechanical unit active	1349
2.106	IsPers - Is persistent	1350
2.107	IsStopMoveAct - Is stop move flags active	1351
2.108	IsStopStateEvent - Test whether moved program pointer	1353
2.109	IsSyncMoveOn - Test if in synchronized movement mode	1355
2.110	IsSysId - Test system identity	1357
2.111	IsVar - Is variable	1358
2.112	Max - Get the largest of two values	1359
2.113	MaxExtLinearSpeed - Maximum additional axis speed	1360
2.114	MaxExtReorientSpeed - Maximum additional axis rotational speed	1361
2.115	MaxRobReorientSpeed - Maximum reorient speed of robot	1362
2.116	MaxRobSpeed - Maximum robot speed	1363
2.117	Min - Get the smallest of two values	1364
2.118	MirPos - Mirroring of a position	1365
2.119	MOD - Evaluates an integer modulo	1367
2.120	ModExist - Check if program module exist	1368
2.121	ModTimeDnum - Get file modify time for the loaded module	1369
2.122	MotionPlannerNo - Get connected motion planner number	1371
2.123	NonMotionMode - Read the Non-Motion execution mode	1373
2.124	NOT - Inverts a logical value	1375
2.125	NOrient - Normalize orientation	1376
2.126	NumToDnum - Converts num to dnum	1378
2.127	NumToStr - Converts numeric value to string	1379
2.128	Offs - Displaces a robot position	1381
2.129	OpMode - Read the operating mode	1383
2.130	OR - Evaluates a logical value	1384
2.131	OrientZYX - Builds an orient from Euler angles	1385
2.132	ORobT - Removes the program displacement from a position	1387
2.133	ParIdPosValid - Valid robot position for parameter identification	1389
2.134	ParIdRobValid - Valid robot type for parameter identification	1392
2.135	PathLengthGet - Reads the current path-length value of the counter	1395
2.136	PathLevel - Get current path level	1397
2.137	PathRecValidBwd - Is there a valid backward path recorded	1399
2.138	PathRecValidFwd - Is there a valid forward path recorded	1402
2.139	PFRestart - Check interrupted path after power failure	1406
2.140	PosInv - Inverts pose data	1407
2.141	PoseMult - Multiplies pose data	1409
2.142	PoseVect - Applies a transformation to a vector	1411
2.143	Pow - Calculates the power of a value	1413
2.144	PowDnum - Calculates the power of a value	1414
2.145	PPMovedInManMode - Test whether the program pointer is moved in manual mode	1415
2.146	Present - Tests if an optional parameter is used	1416
2.147	ProgMemFree - Get the size of free program memory	1418
2.148	PrxGetMaxRecordpos - Get the maximum sensor position	1419
2.149	Rand - Generate a random number	1420
2.150	RawBytesLen - Get the length of rawbytes data	1422
2.151	ReadBin - Reads a byte from a file or I/O device	1424
2.152	ReadDir - Read next entry in a directory	1426
2.153	ReadMotor - Reads the current motor angles	1429

2.154	ReadNum - Reads a number from a file or I/O device	1431
2.155	ReadStr - Reads a string from a file or I/O device	1434
2.156	ReadStrBin - Reads a string from a binary I/O device or file	1438
2.157	ReadVar - Read variable from a device	1440
2.158	RelTool - Make a displacement relative to the tool	1442
2.159	RemainingRetries - Remaining retries left to do	1444
2.160	RMQGetSlotName - Get the name of an RMQ client	1445
2.161	RobName - Get the TCP robot name	1447
2.162	RobOS - Check if execution is on RC or VC	1449
2.163	Round - Round a numeric value	1450
2.164	RoundDnum - Round a numeric value	1452
2.165	RunMode - Read the running mode	1454
2.166	SafetyControllerGetChecksum - Get the checksum for the user configuration file	1456
2.167	SafetyControllerGetOpModePinCode - Get the operating mode pin code	1457
2.168	SafetyControllerGetSWVersion - Get the safety controller firmware version	1458
2.169	SafetyControllerGetUserChecksum - Get the checksum for protected parameters	1459
2.170	Sin - Calculates the sine value	1460
2.171	SinDnum - Calculates the sine value	1461
2.172	SocketGetStatus - Get current socket state	1462
2.173	SocketPeek - Test for the presence of data on a socket	1465
2.174	Sqrt - Calculates the square root value	1467
2.175	SqrtDnum - Calculates the square root value	1468
2.176	STCalcForce - Calculate the tip force for a Servo Tool	1469
2.177	STCalcTorque - Calculate the motor torque for a servo tool	1471
2.178	STIsCalib - Tests if a servo tool is calibrated	1473
2.179	STIsClosed - Tests if a servo tool is closed	1475
2.180	STIsIndGun - Tests if a servo tool is in independent mode	1477
2.181	STIsOpen - Tests if a servo tool is open	1478
2.182	StrDigCalc - Arithmetic operations with datatype stringdig	1480
2.183	StrDigCmp - Compare two strings with only digits	1483
2.184	StrFind - Searches for a character in a string	1485
2.185	StrFormat - Format a string	1487
2.186	StrLen - Gets the string length	1489
2.187	StrMap - Maps a string	1490
2.188	StrMatch - Search for pattern in string	1492
2.189	StrMemb - Checks if a character belongs to a set	1494
2.190	StrOrder - Checks if strings are ordered	1496
2.191	StrPart - Finds a part of a string	1498
2.192	StrToByte - Converts a string to a byte data	1500
2.193	StrToVal - Converts a string to a value	1502
2.194	Tan - Calculates the tangent value	1504
2.195	TanDnum - Calculates the tangent value	1505
2.196	TaskRunMec - Check if task controls any mechanical unit	1506
2.197	TaskRunRob - Check if task controls some robot	1507
2.198	TasksInSync - Returns the number of synchronized tasks	1508
2.199	TaskIsActive - Check if a normal task is active	1510
2.200	TaskIsExecuting - Check if task is executing	1512
2.201	TestAndSet - Test variable and set if unset	1514
2.202	TestDI - Tests if a digital input is set	1517
2.203	TestSignRead - Read test signal value	1519
2.204	TextGet - Get text from system text tables	1521
2.205	TextTabFreeToUse - Test whether text table is free	1524
2.206	TextTabGet - Get text table number	1526
2.207	TriggDataValid - Check if the content in a triggdata variable is valid	1528
2.208	Trunc - Truncates a numeric value	1530
2.209	TruncDnum - Truncates a numeric value	1532
2.210	Type - Get the data type name for a variable	1534
2.211	UIAlphaEntry - User Alpha Entry	1536
2.212	UIClientExist - Exist User Client	1543

2.213	UIDnumEntry - User Number Entry	1544
2.214	UIDnumTune - User Number Tune	1551
2.215	UIListView - User List View	1558
2.216	UIMessageBox - User Message Box type advanced	1567
2.217	UINumEntry - User Number Entry	1576
2.218	UINumTune - User Number Tune	1583
2.219	ValidIO - Valid I/O signal to access	1590
2.220	ValToStr - Converts a value to a string	1592
2.221	VectMagn - Magnitude of a pos vector	1594
2.222	XOR - Evaluates a logical value	1596
3	Data types	1597
3.1	aiotrigg - Analog I/O trigger condition	1597
3.2	ALIAS - Assigning an alias data type	1599
3.3	bool - Logical values	1600
3.4	btnres - Push button result data	1601
3.5	busstate - State of I/O network	1603
3.6	buttondata - Push button data	1604
3.7	byte - Integer values 0-255	1606
3.8	cameradev - camera device	1607
3.9	camerastatus - Camera communication status	1608
3.10	cameratarget - camera data	1610
3.11	capaptrreferencedata - Variable setup data for At-Point-Tracker	1612
3.12	capdata - CAP data	1614
3.13	caplatrackdata - CAP Look-Ahead-Tracker track data	1618
3.14	capspeeddata - Speed data for CAP	1622
3.15	capstopmode - Defines stop modes for CAP	1624
3.16	captrackdata - CAP track data	1625
3.17	capweavedata - Weavedata for CAP	1628
3.18	cfgdomain - Configuration domain	1635
3.19	clock - Time measurement	1636
3.20	confdata - Robot configuration data	1637
3.21	corrdescr - Correction generator descriptor	1644
3.22	datapos - Enclosing block for a data object	1646
3.23	dionum - Digital values (0-1)	1647
3.24	dir - File directory structure	1648
3.25	dnum - Double numeric values	1649
3.26	errdomain - Error domain	1651
3.27	errnum - Error number	1653
3.28	errstr - Error string	1661
3.29	errtype - Error type	1662
3.30	event_type - Event routine type	1663
3.31	exec_level - Execution level	1664
3.32	extjoint - Position of external joints	1665
3.33	flypointdata - Data for flying start/end	1667
3.34	handler_type - Type of execution handler	1670
3.35	icondata - Icon display data	1671
3.36	identno - Identity for move instructions	1673
3.37	intnum - Interrupt identity	1675
3.38	iodev - I/O device	1677
3.39	iounit_state - State of I/O device	1678
3.40	jointtarget - Joint position data	1679
3.41	listitem - List item data structure	1681
3.42	loaddata - Load data	1682
3.43	loadidnum - Type of load identification	1688
3.44	loadsession - Program load session	1689
3.45	mecunit - Mechanical unit	1690
3.46	motsetdata - Motion settings data	1692
3.47	num - Numeric values	1698

Table of contents

3.48	opcalc - Arithmetic Operator	1700
3.49	opnum - Comparison operator	1701
3.50	orient - Orientation	1702
3.51	paridnum - Type of parameter identification	1707
3.52	paridvalidnum - Result of ParIdRobValid	1709
3.53	pathrecid - Path recorder identifier	1711
3.54	pnpdata - Configure pick and place paths	1713
3.55	pos - Positions (only X, Y and Z)	1715
3.56	pose - Coordinate transformations	1717
3.57	processtimes - process times	1718
3.58	progdisp - Program displacement	1719
3.59	rawbytes - Raw data	1721
3.60	restartblkdata - blockdata for restart	1723
3.61	restartdata - Restart data for trigg signals	1725
3.62	rmqheader - RAPID Message Queue Message header	1729
3.63	rmqmessage - RAPID Message Queue message	1731
3.64	rmqslot - Identity number of an RMQ client	1732
3.65	robjoint - Joint position of robot axes	1733
3.66	robtarg - Position data	1734
3.67	sensor - External device descriptor	1738
3.68	sensorstate - Communication state of the device	1740
3.69	sensorvardata - Multiple variable setup data for sensor interface	1741
3.70	shapedata - World zone shape data	1743
3.71	signalorigin - Describes the I/O signal origin	1745
3.72	signalxx - Digital and analog signals	1747
3.73	socketdev - Socket device	1749
3.74	socketstatus - Socket communication status	1750
3.75	speeddata - Speed data	1751
3.76	stoppointdata - Stop point data	1755
3.77	string - Strings	1761
3.78	stringdig - String with only digits	1763
3.79	supervtimeouts - Handshake supervision time outs	1764
3.80	switch - Optional parameters	1766
3.81	symnum - Symbolic number	1767
3.82	syncident - Identity for synchronization point	1768
3.83	System data - Current RAPID system data settings	1769
3.84	taskid - Task identification	1771
3.85	tasks - RAPID program tasks	1772
3.86	testsignal - Test signal	1774
3.87	tooldata - Tool data	1776
3.88	tpnum - FlexPendant window number	1782
3.89	trapdata - Interrupt data for current trap routine	1783
3.90	triggdata - Positioning events, trigg	1785
3.91	triggios - Positioning events, trigg	1786
3.92	triggiosdnum - Positioning events, trigg	1789
3.93	triggmode - Trigg action mode	1791
3.94	triggstrgo - Positioning events, trigg	1794
3.95	tsp_status - Task selection panel status	1797
3.96	tunetype - Servo tune type	1799
3.97	uishownum - Instance ID for UIShow	1800
3.98	weavestartdata - weave start data	1801
3.99	wobjdata - Work object data	1803
3.100	wzstationary - Stationary world zone data	1807
3.101	wztemporary - Temporary world zone data	1809
3.102	zonedata - Zone data	1811
4	Programming type examples	1817
4.1	ERROR handler with movements	1817
4.2	Service routines with or without movements	1820

4.3	System I/O interrupts with or without movements	1823
4.4	Trap routines with movements	1826
Index		1829

This page is intentionally left blank

Overview of this manual

About this manual

This is a technical reference manual intended for the RAPID programmer. The RAPID base instructions, functions and data types are detailed in this manual. This manual describes RobotWare 6.

Usage

This manual should be read during programming and when you need specific information about a RAPID instruction, function or data type.

Who should read this manual?

This manual is intended for someone with some previous experience in programming, for example, a robot programmer.

Prerequisites

The reader should have some programming experience and have studied

- *Technical reference manual - RAPID Overview*

Organization of chapters

The manual is organized in the following chapters:

Chapter	Contents
Instructions	Detailed descriptions of all RAPID base instructions, including examples of how to use them.
Functions	Detailed descriptions of all RAPID base functions, including examples of how to use them.
Data types	Detailed descriptions of all RAPID base data types, including examples of how to use them.
Programming type examples	A general view of how to write program code that contains different instructions/functions/data types. The chapter contains also programming tips and explanations.

References

Reference	Document ID
<i>Technical reference manual - RAPID Overview</i>	3HAC050947-001
<i>Technical reference manual - RAPID kernel</i>	3HAC050946-001
<i>Application manual - Controller software IRC5</i>	3HAC050798-001
<i>Operating manual - RobotStudio</i>	3HAC032104-001

Continues on next page

Revisions

Revision	Description
-	<p>Released with RobotWare 6.0.</p> <p> Note</p> <p>For IRC5 with RobotWare 5, see manual 3HAC16581-001.</p>
A	<p>Released with RobotWare 6.01.</p> <ul style="list-style-type: none"> The following instructions, functions, and data types are added: <ul style="list-style-type: none"> AliasIOReset - Resetting I/O signal with alias name on page 39, TriggJIOs - Joint robot movements with I/O events on page 943 Information about 7-axis robots is added to the data type confdata - Robot configuration data on page 1637.
B	<p>Released with RobotWare 6.02.</p> <ul style="list-style-type: none"> The following common instructions, functions, and data types are added: <ul style="list-style-type: none"> SaveCfgData - Save system parameters to file on page 653, cfgdomain - Configuration domain on page 1635, TriggDataCopy - Copy the content in a triggdata variable on page 906, TriggDataReset - Reset the content in a triggdata variable on page 908, TriggDataValid - Check if the content in a triggdata variable is valid on page 1528 Alnput - Reads the value of an analog input signal on page 1149, Dlnput - Reads the value of a digital input signal on page 1254, Glnput - Read value of group input signal on page 1319 Added all instructions, functions, and data types for the RobotWare option <i>Integrated Vision</i>. Warning about breaking distance is added to SoftAct - Activating the soft servo on page 767. Added trigonometric functions for data type <code>dnum</code>: <code>ACosDnum</code>, <code>ASinDnum</code>, <code>ATanDnum</code>, <code>ATan2Dnum</code>, <code>CosDnum</code>, <code>TanDnum</code>, <code>SinDnum</code> Added RAPID instructions for the functionality EGM Path Correction. Minor corrections.
C	<p>Released with RobotWare 6.03.</p> <ul style="list-style-type: none"> New functionality added to instruction MotionProcessModeSet - Set motion process mode on page 390. Added <i>CAP</i> instructions, functions, and data types. Added <i>Cyclic bool</i> instructions and functions. Added instructions and functions related to Functional Safety. <code>signalxx</code> is now a semi-value data type that permits value oriented operations, see signalxx - Digital and analog signals on page 1747. Minor corrections.
D	<p>Released with RobotWare 6.04.</p> <ul style="list-style-type: none"> Added SafetyControllerGetOpModePinCode - Get the operating mode pin code on page 1457. Added new instructions for displaying wait conditions, see UIMsgWrite - User message dialog box type non-waiting on page 1001. Added the error recovery <code>ERR_TASKNAME</code> where it was missing. Added SetLeadThrough - Activate and deactivate lead-through on page 710 and IsLeadThrough - Check lead-through status on page 1347. Minor corrections.

Continues on next page

Revision	Description
E	<p>Released with RobotWare 6.05.</p> <ul style="list-style-type: none"> • Added new instruction for <i>Integrated Vision</i>, see AliasCamera - Define camera device with alias name on page 34. • Added mathematical instructions for calculating matrixes, see MatrixSolve - Solve a linear equation system on page 371. • Added new instructions for travelling distance and time for track motion, see ResetAxisDistance - Reset the traversed distance information for the axis on page 611. • Added the possibility to interrupt all UI_{xxx} and TP_{xxx} instructions with a persistent boolean. • Added new instructions for handling multiple variables from a device, see WriteVarArr - Write multiple variables to a sensor device on page 1114. • Removed the instructions <code>DitherAct</code> and <code>DitherDeact</code>. • Minor corrections.
F	<p>Released with RobotWare 6.06.</p> <ul style="list-style-type: none"> • Added FitCircle - Fits a circle to 3D-points on page 210. • Added GetJointData - Get joint specific data on page 234. • Added GetTSPStatus - Get current task selection panel status on page 1315 and tsp_status - Task selection panel status on page 1797. • Added IsBrakeCheckActive - Test if brake check is running on page 1337. • Added TasksActive - Check if a normal task is active on page 1510 and TasksExecuting - Check if task is executing on page 1512. • Minor corrections.
G	<p>Released with RobotWare 6.07.</p> <ul style="list-style-type: none"> • Added functions MaxExtLinearSpeed - Maximum additional axis speed on page 1360, MaxExtReorientSpeed - Maximum additional axis rotational speed on page 1361, and MaxRobReorientSpeed - Maximum reorient speed of robot on page 1362. For speeddata - Speed data on page 1751, the predefined value <code>v_{max}</code> is changed to use the max values returned by these functions. • Added the function CrossProd - Cross product of two pos vectors on page 1232. • Added info about quadrants for 7-axis robots to section confdata - Robot configuration data on page 1637. • Updated info about limitations for MoveC - Moves the robot circularly on page 402. • Added limitations for Comment - Comment on page 153. • Clarified program execution when using <code>\LockAxis4</code> in the <code>SingArea</code> instruction. Also removed note saying that <code>\LockAxis4</code> only can be used on serial link robots. See SingArea - Defines interpolation around singular points on page 729. • Updated PathResol - Override path resolution on page 537. • Minor changes to the limitations in WriteCfgData - Writes attribute of a system parameter on page 1104. • Added the instructions CapAPTrSetupAI - Setup an At-Point-Tracker controlled by analog input signals on page 83, CapAPTrSetupAO - Setup an At-Point-Tracker controlled by analog output signals on page 86, CapAPTrSetupPERS - Setup an At-Point-Tracker controlled by persistent variables on page 89, and the data type capaptrreferencedata - Variable setup data for At-Point-Tracker on page 1612. • Added track mode 13, 14, and 15 to the data type <code>trackdata</code>.

Continues on next page

Revision	Description
	<ul style="list-style-type: none"> • Clarified rotation order in OrientZYX - Builds an orient from Euler angles on page 1385 and RelTool - Make a displacement relative to the tool on page 1442. • Added the instructions <code>EGMStreamStart</code>, <code>EGMStreamStop</code> and <code>EGMWaitCond</code>.
H	<p>Released with RobotWare 6.08.</p> <ul style="list-style-type: none"> • Minor corrections. • Updated Limitations with information on declaration of signal variable for AliasIO - Define I/O signal with alias name on page 36. • Added predefined data <code>PRESS_TENDING_MODE</code> to MotionProcess-ModeSet - Set motion process mode on page 390. • Added instruction <code>MovePnP</code> and data type <code>pnpdata</code>. • Added instruction <code>SoftElbow</code>. • Minor changes to zonedata - Zone data on page 1811. Reference to <i>Technical reference manual - RAPID Overview</i>, where changes for corner paths are described in more detail. • Added function <code>GetUASUserName</code>.
J	<p>Released with RobotWare 6.09.</p> <ul style="list-style-type: none"> • Made changes to text and examples for communication, focusing less on serial ports and more on I/O devices in general. • Description of <code>ERR_UNKINO</code> updated in section errnum - Error number on page 1653. • Updated description about the signal access level in WZDOSet - Activate world zone to set digital output on page 1123. • Added missing argument <code>\StreamStart</code> in instructions <code>EGMActJoining</code> and <code>EGMActPose</code>. • Updated description of argument <code>RestartDist</code> in the instruction <code>CapRefresh</code>. • Limitation information updated for several instructions. • The instructions <code>WaitSensor</code>, <code>WaitWObj</code> and <code>Errnum</code> have been updated with information regarding <code>ERR_CNV_OBJ_LOST</code>. • Corrected code example in switch - Optional parameters on page 1766. <p>Added instructions:</p> <ul style="list-style-type: none"> • CAPSetStopMode - Set the stop mode for execution errors on page 126 • GetTorqueMargin - Reads the least torque margin on page 1313 • PathLengthReset - Resets the current path-length value of the counter on page 516 • PathLengthStart - Activates the counter that monitors the path-length on page 518 • PathLengthStop - Stops the counter that monitors the path-length on page 520 • ResetTorqueMargin - Reset least torque margin on page 617 <p>Added functions:</p> <ul style="list-style-type: none"> • PathLengthGet - Reads the current path-length value of the counter on page 1395 <p>Added data types:</p> <ul style="list-style-type: none"> • capstopmode - Defines stop modes for CAP on page 1624
K	<p>Released with RobotWare 6.10.</p> <ul style="list-style-type: none"> • Correction in function <code>PathLengthGet</code>. • Information regarding IRB 5500 added in sections ConfJ - Controls the configuration during joint movement on page 155 and ConfL - Monitors the configuration during linear movement on page 157

Revision	Description
	<ul style="list-style-type: none"> The information regarding <i>Externally Guided Motion</i> is moved to a separate manual, <i>3HAC073319-001</i>.
L	<p>Released with RobotWare 6.10.02.</p> <ul style="list-style-type: none"> Updated information for instructions <code>SetAllDataVal</code> and <code>SetDataSearch</code>.
M	<p>Released with RobotWare 6.11.</p> <ul style="list-style-type: none"> Updated information for function <code>TextGet</code>. New error recovery added for errnum <code>ERR_CAM_NOT_ON_NETWORK</code>. Added instructions: <ul style="list-style-type: none"> SimCollision - Simulate a collision on page 728 StrFormat - Format a string on page 1487 Added functions: <ul style="list-style-type: none"> CamGetMode - Get current mode of camera on page 1213 Added data types: <ul style="list-style-type: none"> camerastatus - Camera communication status on page 1608 <code>STIndGun</code> and <code>STIndGunReset</code> updated with servo tool information. New instruction <code>IOEventMessage</code> added in IOEventMessage - Turn on/off I/O event messages from device on page 295. New function <code>IsCollFree</code> added in IsCollFree - Checks if position would collide on page 1338. Function <code>EGMGetState</code> and data types <code>egmframetype</code> and <code>egmident</code> removed from manual and moved to AM Externally Guided Motion.
N	<p>Released with RobotWare 6.12.</p> <ul style="list-style-type: none"> Added instructions: <ul style="list-style-type: none"> CamStartSetParameter - Start the set-operation of a parameter setting on page 71 CamWaitSetParameter - Wait until a set-operation is ready on page 76 Added functions: <ul style="list-style-type: none"> Rand - Generate a random number on page 1420 Updated information about .xml files in the function TextTabGet - Get text table number on page 1526. Added new arguments (<code>Arg3</code> to <code>Arg6</code>) for <code>StrFormat</code> and <code>TextGet</code>. Added limitation for the instruction <code>StartLoad</code>, see StartLoad - Load a program module during execution on page 787. Updated information about using the instruction <code>Stop</code> in event routines, see Stop - Stops program execution on page 815.
P	<p>Released with RobotWare 6.13.</p> <ul style="list-style-type: none"> Minor image corrections in sections regarding <code>Wait</code> instructions. New example in section WaitUntil - Waits until a condition is met on page 1079. Added prerequisites for GetAxisDistance - Get the traversed distance counter of the axis on page 1283.
Q	<p>Released with RobotWare 6.14.</p> <ul style="list-style-type: none"> Updated descriptions for the functions StrFind - Searches for a character in a string on page 1485, StrMatch - Search for pattern in string on page 1492, and StrMemb - Checks if a character belongs to a set on page 1494. Updated limitation information regarding the instruction <code>STIndGunReset</code>. Added the argument <code>Compact</code> to the functions <code>DnumToStr</code> and <code>NumToStr</code>.

Continues on next page

Revision	Description
	<ul style="list-style-type: none"> • Added the argument <code>MSec</code> to the function <code>GetTime</code>. • Added the optional argument <code>ErrorNumber</code> to <code>WaitUntil</code>. • Added the optional arguments <code>TimeOutSignal</code>, <code>TimeOutGOSignal</code>, and <code>TimeOutGOValue</code> to <code>WaitUntil</code>, <code>WaitDI</code>, <code>WaitDO</code>, <code>WaitGI</code>, <code>WaitGO</code>, <code>WaitAI</code>, and <code>WaitAO</code>. • Added the error <code>ERR_GO_LIM</code> to <code>WaitUntil</code>, <code>WaitDI</code>, <code>WaitDO</code>, <code>WaitAI</code>, and <code>WaitAO</code>. • Added the errors <code>ERR_UI_NOACTION</code>, <code>ERR_UI_BUTTONS</code>, and <code>ERR_UI_ICON</code> in <code>errnum</code> and the related instructions and functions. • Minor corrections.
R	<p>Released with RobotWare 6.15.</p> <ul style="list-style-type: none"> • Updated information about the argument <code>Signal</code> for the instruction SetupCyclicBool - Setup a Cyclic bool condition on page 715.
S	<p>Released with RobotWare 6.15.03.</p> <ul style="list-style-type: none"> • Added the function GetNextOption - Get name of options installed on page 1298. • Added the instruction TriggAbsJ - Absolute joint robot movements with events on page 883. • Removed the error <code>ERR_UI_NOACTION</code>. • Minor corrections.
T	<p>Released with RobotWare 6.15.04.</p> <ul style="list-style-type: none"> • Added instructions: <ul style="list-style-type: none"> - MatrixAdd - Calculates the sum of two matrices on page 358 - MatrixInverse - Inverse a matrix on page 361 - MatrixMult - Multiply two matrices or multiply matrix with scalar on page 364 - MatrixReset - Set all elements in a matrix to 0 on page 369 - MatrixSub - Calculates the difference between two matrices on page 376 - MatrixTranspose - Transpose a matrix on page 382 • Updated description for the data type stoppointdata - Stop point data on page 1755.
U	<p>Released with RobotWare 6.15.05.</p> <ul style="list-style-type: none"> • Added the error handler <code>ERR_SOCK_EXEC_LEVEL</code>, for <code>SocketAccept</code>, <code>SocketBind</code>, <code>SocketConnect</code>, <code>SocketPeek</code>, <code>SocketReceive</code>, <code>SocketReceiveFrom</code>. • Corrections done in example and arguments for the instruction CapAPTSetupPERS - Setup an At-Point-Tracker controlled by persistent variables on page 89.
V	<p>Released with RobotWare 6.15.06.</p> <ul style="list-style-type: none"> • The following instructions are added: <ul style="list-style-type: none"> - FitLine - Fits a line to a set of points on page 214 - FitPlane - Fits a plane to a set of points on page 216 - FitSphere - Fit a sphere to a set of points on page 218

1 Instructions

1.1 AccSet - Reduces the acceleration

Usage

`AccSet` is used when handling fragile loads or in order to decrease vibrations and path errors. It allows slower acceleration and deceleration, which results in smoother robot movements.

This instruction can only be used in the main task `T_ROB1` or, if in a MultiMove system, in Motion tasks.

Basic examples

The following examples illustrate the instruction `AccSet`:

Example 1

```
AccSet 50, 100;
```

The acceleration is limited to 50% of the normal value.

Example 2

```
AccSet 100, 50;
```

The acceleration ramp is limited to 50% of the normal value, which means that the time to reach the acceleration is increased by a factor of 2.

Example 3

```
AccSet 100, 100 \FinePointRamp:=50;
```

The deceleration ramp when decelerating towards a finepoint is limited to 50% of the normal value.

Arguments

```
AccSet Acc Ramp [\FinePointRamp]
```

`Acc`

Data type: num

Acceleration and deceleration as a percentage of the normal values. 100% corresponds to maximum acceleration. Input value < 20% gives 20% of maximum acceleration.

`Ramp`

Data type: num

The rate at which acceleration and deceleration increases as a percentage of the normal values. Jerking can be restricted by reducing this value. 100% corresponds to maximum rate. Input value < 10% gives 10% of maximum rate.

Continues on next page

1 Instructions

1.1 AccSet - Reduces the acceleration

RobotWare Base

Continued

The figures show that reducing the acceleration results in smoother movements.

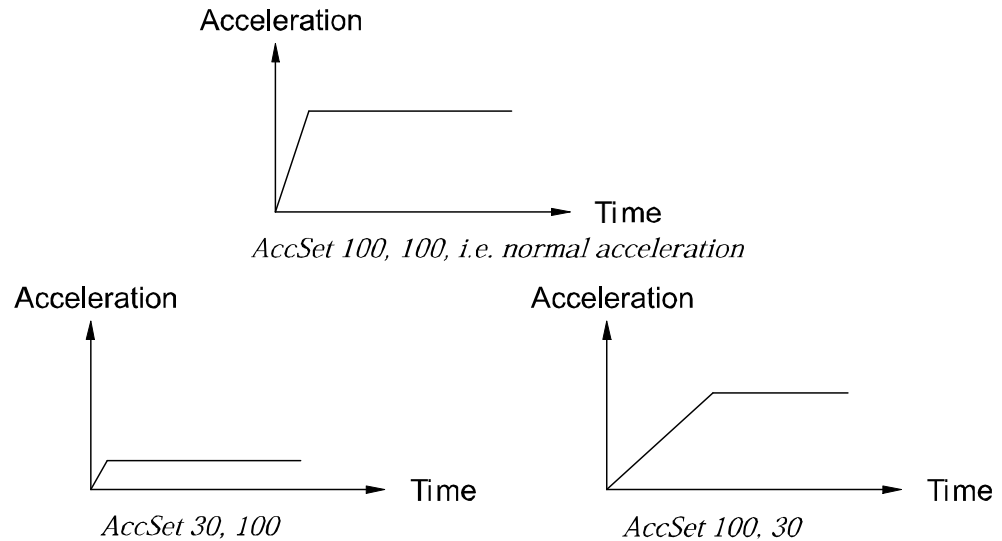

xx0500002146

[\FinePointRamp]

Data type: num

The rate at which deceleration decreases as a percentage of the normal values. The parameter only affects the ramp when the robot decelerates towards a finepoint. In a finepoint the deceleration ramp value is a combination of this parameter and the Ramp value, $\text{Ramp} * \text{FinePointRamp}$. The parameter must be greater than 0 and be in the interval 0 to 100%.

If this optional argument is not used, the FinePointRamp value is set to the default value, 100%.

Program execution

The acceleration applies for the next executed movement instruction, for both the robot and external axes, until a new AccSet instruction is executed.

The default values (AccSet 100, 100) are automatically set

- when using the restart mode **Reset RAPID**
- when loading a new program or a new module
- when starting program execution from the beginning
- when moving the program pointer to main
- when moving the program pointer to a routine
- when moving the program pointer in such a way that the execution order is lost.

Syntax

```
AccSet  
  [ Acc ':=' ] < expression (IN) of num > ','  
  [ Ramp ':=' ] < expression (IN) of num >  
  [ '\FinePointRamp ':=' < expression (IN) of num > ] ';' ;
```

Continues on next page

Related information

For information about	See
Motion settings data	motsetdata - Motion settings data on page 1692
Reduce TCP acceleration along the path	PathAccLim - Reduce TCP acceleration along the path on page 512
Definition of maximum velocity	VelSet - Changes the programmed velocity on page 1017
Control acceleration in world coordinate system	WorldAccLim - Control acceleration in world coordinate system on page 1093
Positioning instructions	<i>Technical reference manual - RAPID Overview</i>

1 Instructions

1.2 ActEventBuffer - Activation of event buffer

RobotWare Base

1.2 ActEventBuffer - Activation of event buffer

Description

`ActEventBuffer` is used to activate the use of the event buffer in current motion program task.

The instructions `ActEventBuffer` and `DeactEventBuffer` should be used when combining an application using finepoints and a continuous application where signals needs to be set in advance due to slow process equipment.

This instruction can only be used in the main task `T_ROB1` or, if in a `MultiMove` system, in Motion tasks.

Basic examples

The following example illustrates the instruction `ActEventBuffer`:

Example 1

```
...
DeactEventBuffer;
! Use an application that uses finepoints, such as SpotWelding
...
! Activate the event buffer again
ActEventBuffer;
! Now it is possible to use an application that needs
! to set signals in advance, such as Dispense
...
```

The `DeactEventBuffer` deactivates the configured event buffer. When using an application with finepoints, the start of the robot from the finepoint will be faster. When activating the event buffer with `ActEventBuffer`, it is possible to set signals in advance for an application with slow process equipment.

Program execution

The use of an event buffer applies for the next executed robot movement instruction of any type and is valid until a `DeactEventBuffer` instruction is executed.

The instruction will wait until the robot and external axes has reached the stop point (`ToPoint` of current move instruction) before the activation of the event buffer. Therefore it is recommended to program the movement instruction preceding `ActEventBuffer` with a fine point.

The default value (`ActEventBuffer`) is automatically set

- when using the restart mode **Reset RAPID**
- when loading a new program or a new module
- when starting program execution from the beginning
- when moving the program pointer to `main`
- when moving the program pointer to a routine
- when moving the program pointer in such a way that the execution order is lost.

Continues on next page

Limitations

ActEventBuffer cannot be executed in a RAPID routine connected to any of the following special system events: PowerOn, Stop, QStop, Restart or Step.

Syntax

```
ActEventBuffer ';' 
```

Related information

For information about	See
Deactivation of event buffer	DeactEventBuffer - Deactivation of event buffer on page 182
Configuration of Event preset time	<i>Technical reference manual - System parameters</i>
Motion settings data	motsetdata - Motion settings data on page 1692

1 Instructions

1.3 ActUnit - Activates a mechanical unit

RobotWare Base

1.3 ActUnit - Activates a mechanical unit

Usage

ActUnit is used to activate a mechanical unit.

It can be used to determine which unit is to be active when, for example, common drive units are used.

This instruction can only be used in the main task T_ROB1 or, if in a MultiMove system, in Motion tasks.

Basic examples

The following example illustrates the instruction ActUnit:

Example 1

```
ActUnit orbit_a;
```

Activation of the orbit_a mechanical unit.

Arguments

```
ActUnit MechUnit
```

MechUnit

Mechanical Unit

Data type: mecunit

The name of the mechanical unit to be activated.

Program execution

When the robot and the actual path of external axes are ready, the path on current path level is cleared and the specified mechanical unit is activated. This means that it is controlled and monitored by the robot.

If several mechanical units share a common drive unit, activation of one of these mechanical units will also connect that unit to the common drive unit.

Limitations

If this instruction is preceded by a move instruction, that move instruction must be programmed with a stop point (zonedata fine), not a fly-by point, otherwise restart after power failure will not be possible.

ActUnit cannot be executed in a RAPID routine connected to any of the following special system events: PowerOn, Stop, QStop, Restart, Reset or Step.

It is possible to use ActUnit - DeactUnit on StorePath level, but the same mechanical units must be active when doing RestoPath as when StorePath was done. Such operation on the Path Recorder and the path on the base level will be intact, but the path on the StorePath level will be cleared.

Syntax

```
ActUnit  
  [ MechUnit ::= ] < variable (VAR) of mecunit > ';' ;
```

Continues on next page

Related information

For information about	See
Deactivating mechanical units	DeactUnit - Deactivates a mechanical unit on page 184
Mechanical units	mecunit - Mechanical unit on page 1690
More examples	DeactUnit - Deactivates a mechanical unit on page 184
Check if a mechanical unit is activated or not.	IsMechUnitActive - Is mechanical unit active on page 1349
Path Recorder	PathRecMoveBwd - Move path recorder backwards on page 522

1 Instructions

1.4 Add - Adds a numeric value

RobotWare Base

1.4 Add - Adds a numeric value

Usage

Add is used to add or subtract a value to or from a numeric variable or persistent.

Basic examples

The following examples illustrate the instruction Add:

Example 1

```
Add reg1, 3;
```

3 is added to reg1, that is, `reg1:=reg1+3`.

Example 2

```
Add reg1, -reg2;
```

The value of reg2 is subtracted from reg1, that is, `reg1:=reg1-reg2`.

Example 3

```
VAR dnum mydnum:=5;  
Add mydnum, 500000000;
```

500000000 is added to mydnum, that is, `mydnum:=mydnum+500000000`.

Example 4

```
VAR dnum mydnum:=5000;  
VAR num mynum:=6000;  
Add mynum, DnumToNum(mydnum \Integer);
```

5000 is added to mynum, that is, `mynum:=mynum+5000`. You have to use `DnumToNum` to get a num numeric value that you can use together with the num variable mynum.

Arguments

Add Name | Dname AddValue | AddDvalue

Name

Data type: num

The name of the variable or persistent to be changed.

Dname

Data type: dnum

The name of the variable or persistent to be changed.

AddValue

Data type: num

The value to be added.

AddDvalue

Data type: dnum

The value to be added.

Continues on next page

Limitations

If the value to be added is of the type `dnum`, and the variable/persistent that should be changed is a `num`, a runtime error will be generated. The combination of arguments is not possible (see Example 4 above how to solve this).

Syntax

Add

```
[ Name ':=' ] < var or pers (INOUT) of num >  
| [ Dname ':=' ] < var or pers (INOUT) of dnum > ', '  
[ AddValue ':=' ] < expression (IN) of num >  
| [ AddDvalue ':=' ] < expression (IN) of dnum > ';' 
```

Related information

For information about	See
Incrementing a variable by 1	Incr - Increments by 1 on page 260
Decrementing a variable by 1	Decr - Decrements by 1 on page 186
Changing data using an arbitrary expression, for example, multiplication	":=" - Assigns a value on page 41

1 Instructions

1.5 AliasCamera - Define camera device with alias name

Integrated Vision

1.5 AliasCamera - Define camera device with alias name

Usage

`AliasCamera` is used to define a camera with an alias name or to use cameras in built-in task modules. Cameras with alias names can be used for predefined generic programs. The instruction `AliasCamera` must be run before any use of the actual camera.

Basic examples

The following examples illustrate the instruction `AliasCamera`.

Example 1

```
VAR cameradev mycamera;
...
PROC prog_start()
  AliasCamera "CAMERA1", mycamera;
  ...
  CamReqImage mycamera;
```

The routine `prog_start` is executed in the beginning of the RAPID program. Instruction `AliasCamera` searches for the predefined RAPID camera device variable named `CAMERA1`, and the content of it is copied to `mycamera`. From now, it is possible to access the camera with `mycamera` camera device.

Example 2

```
VAR cameradev mycamera;
PROC procl()
  IF GetTaskName() = "T_ROB_L" THEN
    AliasCamera CAMERA_L, mycamera;
  ELSE
    AliasCamera CAMERA_R, mycamera;
  ENDIF
  ...
  CamReqImage mycamera;
```

The routine `procl` is connected to the `START` event in the system parameters. The program defining the camera device `mycamera` is connected to the configured camera `CAMERA_L` or `CAMERA_R` at program start.

Arguments

```
AliasCamera CameraName | FromCamera ToCamera
```

CameraName

Data type: string

The camera identifier according to the system parameter Communication configuration. The instruction `AliasCamera` searches for the predefined RAPID camera device variable (installed data) with the name used in `CameraName`, and copies the content of it.

FromCamera

Data type: cameradev

Continues on next page

1.5 AliasCamera - Define camera device with alias name

Integrated Vision

Continued

The camera identifier in the system parameter Communication configuration from which the camera device is copied. The camera must be defined in the system parameters.

ToCamera

Data type: cameradev

The camera identifier according to the program to which the camera device is copied. The cameradev must be declared in the RAPID program.

Program execution

The camera device content is copied from the camera given in argument CameraName or FromCamera to the camera device given in argument ToCamera.

Error handling

The following recoverable errors are generated and can be handled in an error handler. The system variable ERRNO will be set to:

ERR_ALIASCAM_DEF	The camera in argument CameraName or the cameradev used in argument FromCamera is not defined in the system parameter Communication configuration. Or the ToCamera is not declared in the RAPID program or is already defined in the system parameter Communication configuration.
------------------	--

Limitation

When starting the program, the alias camera cannot be used until the AliasCamera instruction is executed.

Instruction AliasCamera **must** be placed:

- either in the event routine executed at program start (event START).
- or in the program part executed after every program start (before use of the camera).

To prevent mistakes it is not recommended to use dynamic reconnection of an AliasCamera camera to different physical cameras.

Syntax

```
AliasCamera
  [ CameraName ::= ] < expression (IN) of string >
  | FromCamera ::= < variable (VAR) of cameradev > ', '
  [ ToCamera ::= < variable (VAR) of cameradev > ] ';'

```

Related information

For information about	See
Definition of camera devices	cameradev - camera device on page 1607
Configuration of cameras	<i>Technical reference manual - System parameters</i>
Defining event routines	<i>Technical reference manual - System parameters</i>
Integrated Vision	<i>Application manual - Integrated Vision</i>

1 Instructions

1.6 AliasIO - Define I/O signal with alias name

RobotWare Base

1.6 AliasIO - Define I/O signal with alias name

Usage

AliasIO is used to define a signal of any type with an alias name or to use signals in built-in task modules.

Signals with alias names can be used for predefined generic programs, without any modification of the program before running in different robot installations.

The instruction AliasIO must be run before any use of the actual signal. See [Basic examples on page 36](#) for loaded modules, and [More examples on page 37](#) for installed modules.

Basic examples

The following example illustrates the instruction AliasIO:

See also [More examples on page 37](#).

Example 1

```
VAR signaldo alias_do;
PROC prog_start()
  AliasIO config_do, alias_do;
ENDPROC
```

The routine prog_start is connected to the START event in system parameters. The program defining digital output signal alias_do is connected to the configured digital output signal config_do at program start.

Arguments

```
AliasIO FromSignal ToSignal
```

FromSignal

Data type: signalxx or string

Loaded modules:

The signal identifier named according to the configuration (data type signalxx) from which the signal descriptor is copied. The signal must be defined in the I/O configuration.

Installed modules or loaded modules:

A reference (CONST, VAR or parameter of these) containing the name of the signal (data type string) from which the signal descriptor after search in the system is copied. The signal must be defined in the I/O configuration.

ToSignal

Data type: signalxx

The signal identifier according to the program (data type signalxx) to which the signal descriptor is copied. The signal must be declared in the RAPID program.

The same data type must be used (or found) for the arguments FromSignal and ToSignal and must be one of type signalxx (signalai, signalao, signaldi, signaldo, signalgi, or signalgo).

Continues on next page

Program execution

The signal descriptor value is copied from the signal given in argument `FromSignal` to the signal given in argument `ToSignal`.

Error handling

The following recoverable errors are generated and can be handled in an error handler. The system variable `ERRNO` will be set to:

Name	Cause of error
<code>ERR_ALIASIO_DEF</code>	The <code>FromSignal</code> is not defined in the I/O configuration, or the <code>ToSignal</code> is not declared in the RAPID program, or the <code>ToSignal</code> is not defined in the I/O configuration.
<code>ERR_ALIASIO_TYPE</code>	The data types for the arguments <code>FromSignal</code> and <code>ToSignal</code> is not the same type.
<code>ERR_NO_ALIASIO_DEF</code>	The signal variable is a variable declared in RAPID. It has not been connected to an I/O signal defined in the I/O configuration with instruction <code>AliasIO</code> .

More examples

More examples of the instruction `AliasIO` are illustrated below.

Example 1

```
VAR signaldi alias_di;
PROC prog_start()
  CONST string config_string := "config_di";
  AliasIO config_string, alias_di;
ENDPROC
```

The routine `prog_start` is connected to the `START` event in system parameters. The program defined digital input signal `alias_di` is connected to the configured digital input signal `config_di` (via constant `config_string`) at program start.

Limitations

When starting the program, the alias signal cannot be used until the `AliasIO` instruction is executed.

The signal variable should be declared globally in the module. It must not be a part of a `RECORD` component or declared locally in a procedure (otherwise the refresh of the signal after power fail restart will not work as it should).

Instruction `AliasIO` must be placed

- either in the event routine executed at program start (event `START`)
- or in the program part executed after every program start (before use of the signal)

To prevent mistakes it is not recommended to use dynamic reconnection of an `AliasIO` signal to different physical signals.

Syntax

```
AliasIO
  [ FromSignal ':' ] < reference (REF) of anytype > ','
  [ ToSignal ':' ] < variable (VAR) of anytype > ';' ;'
```

Continues on next page

1 Instructions

1.6 AliasIO - Define I/O signal with alias name

RobotWare Base

Continued

Related information

For information about	See
Reset I/O signal with alias name	AliasIOReset - Resetting I/O signal with alias name on page 39
Input/Output instructions	<i>Technical reference manual - RAPID Overview</i>
Input/Output functionality in general	<i>Technical reference manual - RAPID Overview</i>
Get information about the origin of an I/O signal	GetSignalOrigin - Get information about the origin of an I/O signal on page 1304
Configuration of I/O	<i>Technical reference manual - System parameters</i>
Defining event routines	<i>Technical reference manual - System parameters</i>
Loaded/Installed task modules	<i>Technical reference manual - System parameters</i>
<i>Advanced RAPID</i>	<i>Application manual - Controller software IRC5</i>

1.7 AliasIOReset - Resetting I/O signal with alias name

Usage

`AliasIOReset` is used to reset a signal that has been used in a previous call to `AliasIO`.

Basic examples

The following example illustrates the instruction `AliasIOReset`:

Example 1

```
VAR signaldo alias_do;
PROC myproc()
  AliasIO config_do, alias_do;
  SetDO alias_do, 1;
  ..
  AliasIOReset alias_do;
ENDPROC
```

The program defined digital output signal `alias_do` is connected to the configured digital output signal `config_do` at the beginning of the procedure `myproc`. The signal `config_do` is defined in the I/O configuration. Later on, when `alias_do` should not be used anymore, the alias coupling is removed.

Arguments

`AliasIOReset` Signal

Signal

Data type: `signalxx`

The signal identifier according to the program (data type `signalxx`) that should be reset. The signal must be declared in the RAPID program.

Program execution

The entire alias coupling is removed. The signal cannot be used until a new alias coupling with `AliasIO` is done.

Limitation

Signals that are defined in the I/O configuration can not be reset. Only signals that have been used in an `AliasIO` instruction and are declared in the RAPID program can be used.

Syntax

```
AliasIOReset
  [ Signal ::= ] < variable (VAR) of anytype > ';'

```

Related information

For information about	See
Define I/O signal with alias name	AliasIO - Define I/O signal with alias name on page 36

Continues on next page

1 Instructions

1.7 AliasIOReset - Resetting I/O signal with alias name

RobotWare Base

Continued

For information about	See
Input/Output instructions	<i>Technical reference manual - RAPID Overview</i>
Get information about the origin of an IO signal	GetSignalOrigin - Get information about the origin of an I/O signal on page 1304
Input/Output functionality in general	<i>Technical reference manual - RAPID Overview</i>
Configuration of I/O	<i>Technical reference manual - System parameters</i>
Defining event routines	<i>Technical reference manual - System parameters</i>
Loaded/Installed task modules	<i>Technical reference manual - System parameters</i>
<i>Advanced RAPID</i>	<i>Application manual - Controller software IRC5</i>

1.8 " := " - Assigns a value

Usage

The " := " instruction is used to assign a new value to data. This value can be anything from a constant value to an arithmetic expression, for example, `reg1+5*reg3`.

Basic examples

The following examples illustrate the instruction " := ":
See also [More examples on page 41](#).

Example 1

```
reg1 := 5;
```

`reg1` is assigned the value 5.

Example 2

```
reg1 := reg2 - reg3;
```

`reg1` is assigned the value that the `reg2-reg3` calculation returns.

Example 3

```
counter := counter + 1;
```

`counter` is incremented by one.

Arguments

```
Data := Value
```

Data

Data type: All
The data that is to be assigned a new value.

Value

Data type: Same as Data
The desired value.

More examples

More examples of the instruction " := " are illustrated below.

Example 1

```
tool1.tframe.trans.x := tool1.tframe.trans.x + 20;
```

The TCP for `tool1` is shifted 20 mm in the X-direction.

Example 2

```
pallet{5,8} := Abs(value);
```

An element in the `pallet` matrix is assigned a value equal to the absolute value of the `value` variable.

Limitations

The data (whose value is to be changed) must not be

- a constant

Continues on next page

1 Instructions

1.8 " := " - Assigns a value

RobotWare Base

Continued

- a non-value data type.

The data and value must have similar (the same or alias) data types.

Syntax

```
<assignment target> ':=' <expression> ';' 
```

Related information

For information about	See
Expressions	<i>Technical reference manual - RAPID Overview</i>
Non-value data types	<i>Technical reference manual - RAPID Overview</i>
Assigning an initial value to data	<i>Operating manual - IRC5 with FlexPendant</i>

1.9 BitClear - Clear a specified bit in a byte or dnum data

Usage

`BitClear` is used to clear (set to 0) a specified bit in a defined `byte` data or `dnum` data.

Basic examples

The following examples illustrate the instruction `BitClear`:

Example 1

```
CONST num parity_bit := 8;
VAR byte data1 := 130;
BitClear data1, parity_bit;
```

Bit number 8 (`parity_bit`) in the variable `data1` will be set to 0, for example, the content of the variable `data1` will be changed from 130 to 2 (integer representation). Bit manipulation of data type `byte` when using `BitClear` is illustrated in the following figure.

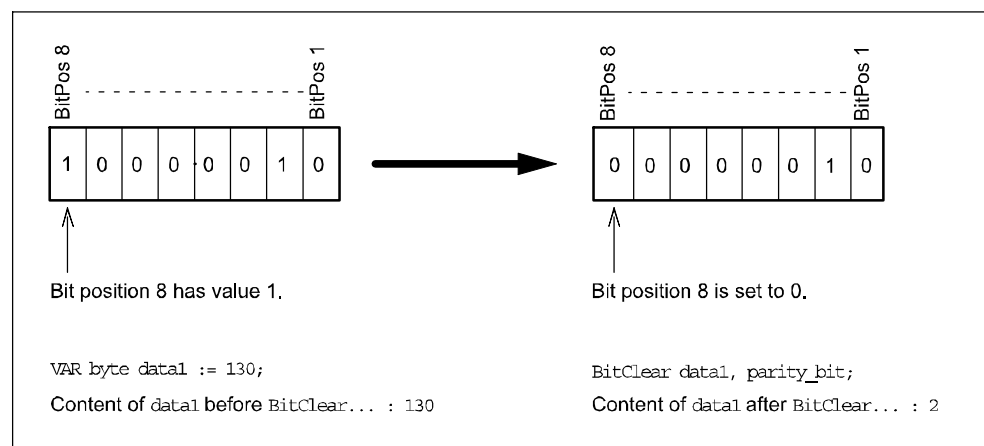

xx0500002147

Example 2

```
CONST num parity_bit := 52;
VAR dnum data2 := 2251799813685378;
BitClear data2, parity_bit;
```

Bit number 52 (`parity_bit`) in the variable `data2` will be set to 0, e.g. the content of the variable `data2` will be changed from 2251799813685378 to 130 (integer

Continues on next page

1 Instructions

1.9 BitClear - Clear a specified bit in a byte or dnum data

RobotWare Base

Continued

representation). Bit manipulation of data type `dnum` when using `BitClear` is illustrated in the figure below.

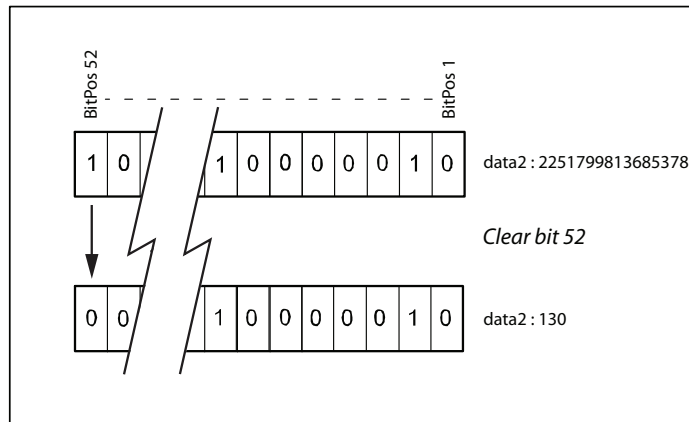

xx120000014

Arguments

```
BitClear BitData | DnumData BitPos
```

BitData

Data type: `byte`

The bit data, in integer representation, to be changed.

DnumData

Data type: `dnum`

The dnum bit data, in integer representation, to be changed.

BitPos

Bit Position

Data type: `num`

The bit position (1-8) in the `BitData`, or bit position (1-52) in the `DnumData`, to be set to 0.

Limitations

The range for a data type `byte` is 0 - 255 decimal.

The bit position is valid from 1 - 8 for data type `byte`.

The range for a data type `dnum` is 0 - 4503599627370495 decimal.

The bit position is valid from 1 - 52 for data type `dnum`.

Syntax

```
BitClear  
[ BitData ':' ] < var or pers (INOUT) of byte >  
| [ DnumData ':' ] < var or pers (INOUT) of dnum > ','  
[ BitPos ':' ] < expression (IN) of num > ';' 
```

Continues on next page

1.9 BitClear - Clear a specified bit in a byte or dnum data

RobotWare Base

Continued

Related information

For information about	See
Set a specified bit in a byte or dnum data	BitSet - Set a specified bit in a byte or dnum data on page 46
Check if a specified bit in a byte data is set	BitCheck - Check if a specified bit in a byte data is set on page 1168
Check if a specified bit in a dnum data is set	BitCheckDnum - Check if a specified bit in a dnum data is set on page 1170
Other bit functions	<i>Technical reference manual - RAPID Overview</i>
<i>Advanced RAPID</i>	<i>Application manual - Controller software IRC5</i>

1 Instructions

1.10 BitSet - Set a specified bit in a byte or dnum data

RobotWare Base

1.10 BitSet - Set a specified bit in a byte or dnum data

Usage

`BitSet` is used to set a specified bit to 1 in a defined `byte` data or `dnum` data.

Basic examples

The following examples illustrate the instruction `BitSet`:

Example 1

```
CONST num parity_bit := 8;  
VAR byte data1 := 2;  
BitSet data1, parity_bit;
```

Bit number 8 (`parity_bit`) in the variable `data1` will be set to 1, for example, the content of the variable `data1` will be changed from 2 to 130 (integer representation). Bit manipulation of data type `byte` when using `BitSet` is illustrated in the figure below.

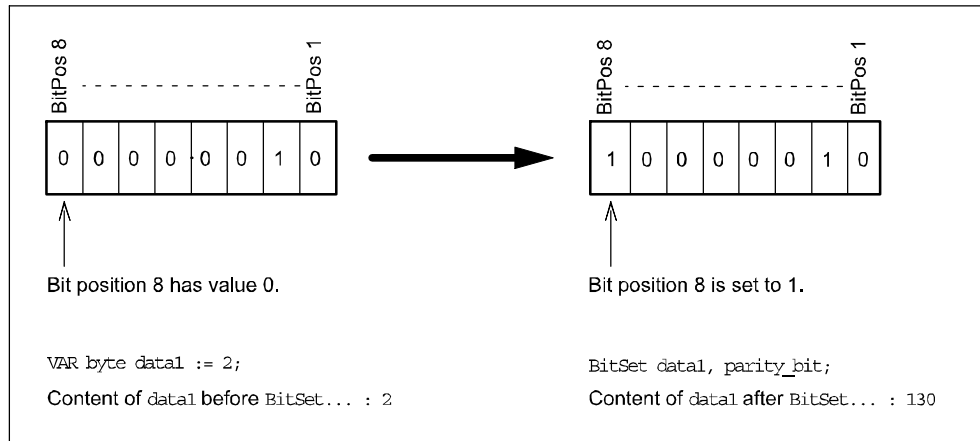

xx0500002148

Example 2

```
CONST num parity_bit := 52;  
VAR dnum data2 := 130;  
BitSet data2, parity_bit;
```

Bit number 52 (`parity_bit`) in the variable `data2` will be set to 1, e.g. the content of the variable `data2` will be changed from 130 to 2251799813685378 (integer

Continues on next page

representation). Bit manipulation of data type `dnum` when using `BitSet` is illustrated in the figure below.

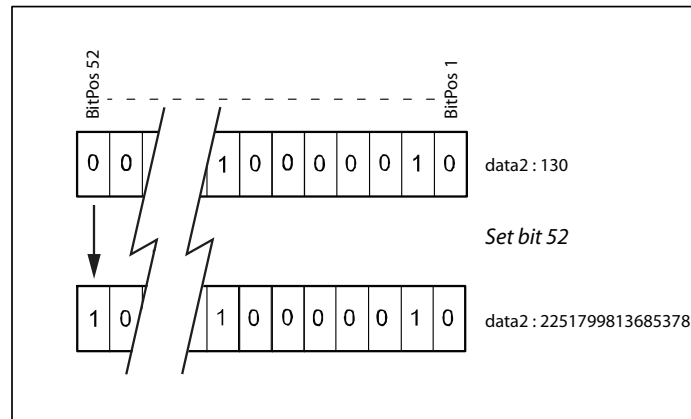

xx120000015

Arguments

`BitSet BitData | DnumData BitPos`

`BitData`

Data type: `byte`

The bit data, in integer representation, to be changed.

`DnumData`

Data type: `dnum`

The bit data, in integer representation, to be changed.

`BitPos`

Bit Position

Data type: `num`

The bit position (1-8) in the `BitData`, or bit position (1-52) in the `DnumData`, to be set to 1.

Limitations

The range for a data type `byte` is integer 0 - 255.

The bit position is valid from 1 - 8 for data type `byte`.

The range for a data type `dnum` is integer 0 - 4503599627370495.

The bit position is valid from 1 - 52 for data type `dnum`.

Syntax

```
BitSet
[ BitData := ' ] < var or pers (INOUT) of byte >
| [ DnumData := ' ] < var or pers (INOUT) of dnum > ', '
[ BitPos := ' ] < expression (IN) of num > ';'

```

Continues on next page

1 Instructions

1.10 BitSet - Set a specified bit in a byte or dnum data

RobotWare Base

Continued

Related information

For information about	See
Clear a specified bit in a byte or dnum data	BitClear - Clear a specified bit in a byte or dnum data on page 43
Check if a specified bit in a byte data is set	BitCheck - Check if a specified bit in a byte data is set on page 1168
Check if a specified bit in a dnum data is set	BitCheckDnum - Check if a specified bit in a dnum data is set on page 1170
Other bit functions	<i>Technical reference manual - RAPID Overview</i>
<i>Advanced RAPID</i>	<i>Application manual - Controller software IRC5</i>

1.11 BookErrNo - Book a RAPID system error number

Usage

`BookErrNo` is used to book a new RAPID system error number.

Basic examples

The following example illustrates the instruction `BookErrNo`:

Example 1

```
! Introduce a new error number in a glue system
! Note: The new error variable must be declared with the initial
      value -1
VAR errnum ERR_GLUEFLOW := -1;

! Book the new RAPID system error number
BookErrNo ERR_GLUEFLOW;
```

The variable `ERR_GLUEFLOW` will be assigned to a free system error number for use in the RAPID code.

```
! Use the new error number
IF di1 = 0 THEN
  RAISE ERR_GLUEFLOW;
ELSE
  ...
ENDIF

! Error handling
ERROR
  IF ERRNO = ERR_GLUEFLOW THEN
    ...
  ELSE
    ...
  ENDIF
```

If the digital input `di1` is 0, the new booked error number will be raised and the system error variable `ERRNO` will be set to the new booked error number. The error handling of those user generated errors can then be handled in the error handler as usual.

Arguments

`BookErrNo` `ErrorName`

`ErrorName`

Data type: `errnum`

The new RAPID system error variable name.

Limitations

The new error variable must not be declared as a routine variable.

The new error variable must be declared with an initial value of -1, that gives the information that this error should be a RAPID system error.

Continues on next page

1 Instructions

1.11 BookErrNo - Book a RAPID system error number

RobotWare Base

Continued

Syntax

```
BookErrNo  
  [ ErrorName ':=' ] < variable (VAR) of errnum > ';' ;
```

Related information

For information about	See
Error handling	<i>Technical reference manual - RAPID Overview</i>
Error number	errnum - Error number on page 1653
Call an error handler	RAISE - Calls an error handler on page 576
<i>Advanced RAPID</i>	<i>Application manual - Controller software IRC5</i>

1.12 Break - Break program execution

Usage

`Break` is used to make an immediate break in program execution for RAPID program code debugging purposes. The robot movement is stopped at once.

Basic examples

The following example illustrates the instruction `Break`:

Example 1

```
...
Break;
...
```

Program execution stops and it is possible to analyze variables, values etc. for debugging purposes.

Program execution

The instruction stops program execution at once, without waiting for the robot and external axes to reach their programmed destination points for the movement being performed at the time. Program execution can then be restarted from the next instruction.

If there is a `Break` instruction in some routine event, the execution of the routine will be interrupted and no `STOP` routine event will be executed. The routine event will be executed from the beginning the next time the same event occurs.

Syntax

```
Break ; '
```

Related information

For information about	See
Stopping for program actions	Stop - Stops program execution on page 815
Stopping after a fatal error	EXIT - Terminates program execution on page 207
Terminating program execution	EXIT - Terminates program execution on page 207
Only stopping robot movements	StopMove - Stops robot movement on page 820

1 Instructions

1.13 CallByVar - Call a procedure by a variable

RobotWare Base

1.13 CallByVar - Call a procedure by a variable

Usage

`CallByVar` (*Call By Variable*) can be used to call procedures with specific names, for example, `proc_name1`, `proc_name2`, `proc_name3` ... `proc_namex` via a variable.

Basic examples

The following example illustrates the instruction `CallByVar`:

See also [More examples on page 52](#).

Example 1

```
reg1 := 2;  
CallByVar "proc", reg1;
```

The procedure `proc2` is called.

Arguments

`CallByVar` Name Number

Name

Data type: string

The first part of the procedure name, for example, `proc_name`.

Number

Data type: num

The numeric value for the number of the procedure. This value will be converted to a string and gives the 2nd part of the procedure name, for example, `1`. The value must be a positive integer.

Error handling

The following recoverable errors can be generated. The errors can be handled in an ERROR handler. The system variable `ERRNO` will be set to:

Name	Cause of error
<code>ERR_ARGVALERR</code>	The argument <code>Number</code> is < 0 or is not an integer.
<code>ERR_REFUNKPRC</code>	The reference is to an unknown procedure.
<code>ERR_CALLPROC</code>	Procedure call error (not procedure).

More examples

More examples of how to make static and dynamic selection of procedure call.

Example 1 - Static selection of procedure call

```
TEST reg1  
CASE 1:  
  lf_door door_loc;  
CASE 2:  
  rf_door door_loc;
```

Continues on next page

```

CASE 3:
  lr_door door_loc;
CASE 4:
  rr_door door_loc;
DEFAULT:
  EXIT;
ENDTEST

```

Depending on whether the value of register `reg1` is 1, 2, 3, or 4, different procedures are called that perform the appropriate type of work for the selected door. The door location in argument `door_loc`.

Example 2 - Dynamic selection of procedure call with RAPID syntax

```

reg1 := 2;
%"proc"+NumToStr(reg1,0)% door_loc;

```

The procedure `proc2` is called with argument `door_loc`.

Limitation: All procedures must have a specific name, for example, `proc1`, `proc2`, `proc3`.

Example 3 - Dynamic selection of procedure call with CallByVar

```

reg1 := 2;
CallByVar "proc",reg1;

```

The procedure `proc2` is called.

Limitation: All procedures must have specific name, for example, `proc1`, `proc2`, `proc3`, and no arguments can be used.

Limitations

Can only be used to call procedures without parameters.

Cannot be used to call LOCAL procedures.

Execution of `CallByVar` takes a little more time than execution of a normal procedure call.

Syntax

```

CallByVar
  [Name ':='] <expression (IN) of string>','
  [Number ':='] <expression (IN) of num>';'

```

Related information

For information about	See
Calling procedures	<i>Technical reference manual - RAPID Overview</i> <i>Operating manual - IRC5 with FlexPendant</i>

1 Instructions

1.14 CamFlush - Removes the collection data for the camera *Integrated Vision*

1.14 CamFlush - Removes the collection data for the camera

Usage

CamFlush is used to flush (remove) the cameratarget collection for the camera.

Basic examples

The following example illustrates the instruction CamFlush.

Example 1

```
CamFlush mycamera;
```

The collection data for camera mycamera is removed.

Arguments

```
CamFlush Camera
```

Camera

Data type: cameradev

The name of the camera.

Syntax

```
CamFlush  
[ Camera ::= ] < variable (VAR) of cameradev > ';' 
```

Related information

For information about	See
Integrated Vision	<i>Application manual - Integrated Vision</i>

1.15 CamGetParameter - Get different named camera parameters

Usage

`CamGetParameter` is used to get named parameters that the camera may expose. The user has to know the name of the parameter and its return type in order to retrieve its value.

Basic examples

The following example illustrates the instruction `CamGetParameter`.

Example 1

```
VAR bool mybool:=FALSE;
...
CamGetParameter mycamera, "Pattern_1.Tool_Enabled_Status"
  \BoolVar:=mybool;
TPWrite "The current value of Pattern_1.Tool_Enabled_Status is: "
  \Bool:=mybool;
```

Get the named boolean parameter `Pattern_1.Tool_Enabled_Status` and write the value on the FlexPendant.

Arguments

```
CamGetParameter Camera ParName [\NumVar] | [\BoolVar] | [\StrVar]
```

Camera

Data type: `cameradev`
The name of the camera.

ParName

Parameter Name
Data type: `string`
The name of the parameter in the camera.

`[\NumVar]`

Data type: `num`
Variable (**VAR**) to store the numeric value of the data object retrieved.

`[\BoolVar]`

Data type: `bool`
Variable (**VAR**) to store the boolean value of the data object retrieved.

`[\StrVar]`

Data type: `string`
Variable (**VAR**) to store the string value of the data object retrieved.

Program execution

The instruction reads the specified parameter directly when the instruction is executed and returns the value.

Continues on next page

1 Instructions

1.15 CamGetParameter - Get different named camera parameters

Integrated Vision

Continued

If the instruction is used to read a result from the image analysis, make sure that the camera has finished processing the image before getting the data.

Error handling

The following recoverable errors can be generated. The errors can be handled in an **ERROR** handler. The system variable `ERRNO` will be set to:

Name	Cause of error
ERR_CAM_BUSY	The camera is busy with some other request and cannot perform the current order.
ERR_CAM_COM_TIMEOUT	Communication error with camera. The camera is probably disconnected.
ERR_CAM_GET_MISMATCH	The parameter fetched from the camera with instruction <code>CamGetParameter</code> has the wrong data type.
ERR_CAM_NOT_ON_NETWORK	The camera is not connected.

Syntax

```
CamGetParameter
  [ Camera := ] < variable (VAR) of cameradev > ', '
  [ ParName := ] < expression (IN) of string >
  [ '\NumVar :=' < variable (VAR) of num > ]
  | [ '\BoolVar :=' < variable (VAR) of bool > ]
  | [ '\StrVar :=' < variable (VAR) of string > ] ';'

```

Related information

For information about	See
Integrated Vision	<i>Application manual - Integrated Vision</i>

1.16 CamGetResult - Gets a camera target from the collection

Usage

`CamGetResult` (*Camera Get Result*) is used to get a camera target from the vision result collection.

Basic examples

The following example illustrates the instruction `CamGetResult`.

Example 1

```
VAR num mysceneid;
VAR cameratarget mycamtarget;
...
CamReqImage mycamera \SceneId:= mysceneid;
CamGetResult mycamera, mycamtarget \SceneId:= mysceneid;
```

Order camera `mycamera` to acquire an image. Get a vision result originating from the image with `SceneId`.

Arguments

```
CamGetResult Camera CamTarget [\SceneId] [\MaxTime]
```

Camera

Data type: `cameradev`
The name of the camera.

CamTarget

Camera Target
Data type: `cameratarget`
The variable where the vision result will be stored.

[\SceneId]

Scene Identification
Data type: `num`
The `SceneId` is an identifier that specifies from which image the `cameratarget` has been generated.

[\MaxTime]

Maximum Time
Data type: `num`
The maximum amount of time in seconds that program execution waits. The maximum allowed value is 120 seconds.

Program execution

`CamGetResult` gets a camera target from the vision result collection. If no `SceneId` or `MaxTime` is used, and there is no result to fetch, the instruction will hang forever. If a `SceneId` is used in `CamGetResult` it should have been generated in a preceding `CamReqImage` instruction.

Continues on next page

1 Instructions

1.16 CamGetResult - Gets a camera target from the collection

Integrated Vision

Continued

The `SceneId` can only be used if the image has been ordered from instruction `CamReqImage`. If images are generated by an external I/O signal, the `SceneId` cannot be used in instruction `CamGetResult`.

Error handling

The following recoverable errors can be generated. The errors can be handled in an ERROR handler. The system variable `ERRNO` will be set to:

Name	Cause of error
<code>ERR_CAM_BUSY</code>	The camera is busy with some other request and cannot perform the current order.
<code>ERR_CAM_MAXTIME</code>	No result could be fetched within the time-out time.
<code>ERR_CAM_NO_MORE_DATA</code>	No more vision results can be fetched for used <code>SceneId</code> , or the result could not be fetched within the time-out time.

Syntax

```
CamGetResult
  [ Camera ::= ] < variable (VAR) of cameradev > ','
  [ CamTarget ::= ] < variable (VAR) of CameraTarget >
  [ '\SceneId ::= ' < expression (IN) of num > ]
  [ '\MaxTime ::= ' < expression (IN) of num > ] ';'

```

Related information

For information about	See
Integrated Vision	<i>Application manual - Integrated Vision</i>

1.17 CamLoadJob - Load a camera task into a camera

Usage

CamLoadJob (*Camera Load Job*) loads a camera task, *job*, describing exposure parameters, calibration, and what vision tools to apply.

Basic examples

The following example illustrates the instruction CamLoadJob.

Example 1

```
CamSetProgramMode mycamera;  
CamLoadJob mycamera, "myjob.job";  
CamSetRunMode mycamera;
```

The job *myjob* is loaded into the camera named *mycamera*.

Arguments

```
CamLoadJob Camera JobName [\KeepTargets] [\MaxTime]
```

Camera

Data type: cameradev

The name of the camera.

Name

Data type: string

The name of the job to load into the camera.

[\KeepTargets]

Data type: switch

This argument is used to specify if any existing camera targets produced by the camera should be kept.

[\MaxTime]

Data type: num

The maximum amount of time in seconds that program execution waits. The maximum allowed value is 120 seconds.

Program execution

The execution of CamLoadJob will wait until the job is loaded or fail with a time-out error. If the optional argument *KeepTargets* is used, the old collection data for the specified camera is kept. The default behavior is to remove (flush) the old collection data.

Error handling

The following recoverable errors can be generated. The errors can be handled in an ERROR handler. The system variable *ERRNO* will be set to:

Name	Cause of error
ERR_CAM_BUSY	The camera is busy with some other request and cannot perform the current order.

Continues on next page

1 Instructions

1.17 CamLoadJob - Load a camera task into a camera

Integrated Vision

Continued

Name	Cause of error
ERR_CAM_COM_TIMEOUT	Communication error with camera. The camera is probably disconnected.
ERR_CAM_MAXTIME	The camera job was not loaded within the time-out time.
ERR_CAM_NOT_ON_NETWORK	The camera is not connected
ERR_CAM_NO_PROGMode	The camera is not in program mode

Limitations

It is only possible to execute `CamLoadJob` when the camera is set in program mode. Use instruction `CamSetProgramMode` to set the camera in program mode. To be able to load the job, the job file must be stored on the camera flash disk.

Syntax

```
CamLoadJob
  [ Camera ':= ' ] < variable (VAR) of cameradev > ', '
  [ JobName ':= ' ] <expression (IN) of string >
  [ '\KeepTargets ]
  [ '\MaxTime ':= ' <expression (IN) of num> ]';'
```

Related information

For information about	See
Integrated Vision	<i>Application manual - Integrated Vision</i>

1.18 CamReqImage - Order the camera to acquire an image

Usage

`CamReqImage` (*Camera Request Image*) orders the camera to acquire an image.

Basic examples

The following example illustrates the instruction `CamReqImage`.

Example 1

```
CamReqImage mycamera;
```

Order camera `mycamera` to acquire an image.

Arguments

```
CamReqImage Camera [\SceneId] [\KeepTargets] [\AwaitComplete]
```

Camera

Data type: `cameradev`

The name of the camera.

[\SceneId]

Scene Identification

Data type: `num`

The optional argument `SceneId` is an identifier for the acquired image. It is generated for each executed `CamReqImage` using the optional argument `SceneId`. The identifier is an integer between 1 and 8388608. If no `SceneId` is used, the identifier value is set to 0.

[\KeepTargets]

Data type: `switch`

This argument is used to specify if old collection data for a specified camera should be kept.

[\AwaitComplete]

Data type : `switch`

If the optional argument `\AwaitComplete` is specified the instruction waits until the results from the image have been received.

When `\AwaitComplete` is used, the camera trigger type has to be set to **External**.

Program execution

`CamReqImage` is ordering a specified camera to acquire an image. If the optional argument `SceneId` is used, the available vision results of an acquired image is marked with the unique number generated by the instruction.

If optional argument `KeepTargets` is used, the old collection data for the specified camera is kept. The default behavior is to remove (flush) any old collection data.

Continues on next page

1 Instructions

1.18 CamReqImage - Order the camera to acquire an image

Integrated Vision

Continued

Error handling

The following recoverable errors can be generated. The errors can be handled in an ERROR handler. The system variable `ERRNO` will be set to:

Name	Cause of error
<code>ERR_CAM_BUSY</code>	The camera is busy with some other request and cannot perform the current order.
<code>ERR_CAM_COM_TIMEOUT</code>	Communication error with camera. The camera is probably disconnected.
<code>ERR_CAM_NO_RUNMODE</code>	The camera is not in running mode
<code>ERR_CAM_NOT_ON_NETWORK</code>	The camera is not connected.

Limitations

It is only possible to execute `CamReqImage` when the camera is set in running mode. Use instruction `CamSetRunMode` to set the camera in running mode.

Syntax

```
CamReqImage
[ Camera ':' ] < variable (VAR) of cameradev > ','
[ '\SceneId ':' ] < variable (VAR) of num > ]
[ '\KeepTargets ]
[ '\AwaitComplete ]';'
```

Related information

For information about	See
Integrated Vision	<i>Application manual - Integrated Vision</i>

1.19 CamSetExposure - Set camera specific data

Usage

CamSetExposure (*Camera Set Exposure*) sets camera specific data and makes it possible to adapt image parameters depending on ambient lighting conditions.

Basic examples

The following example illustrates the instruction CamSetExposure.

Example 1

```
CamSetExposure mycamera \ExposureTime:=10;
```

Order the camera mycamera to change the exposure time to 10 ms.

Arguments

```
CamSetExposure Camera [\ExposureTime] [\Brightness] [\Contrast]
```

Camera

Data type: cameradev

The name of the camera.

[\ExposureTime]

Data type: num

If this optional argument is used, the exposure time of the camera is updated. The value is in milliseconds (ms).

[\Brightness]

Data type: num

If this optional argument is used, the brightness setting of the camera is updated. The value is normally expressed on a scale from 0 to 1.

[\Contrast]

Data type: num

If this optional argument is used, the contrast setting of the camera is updated. The value is normally expressed on a scale from 0 to 1.

Program execution

The instruction updates the exposure time, brightness and contrast if it is possible to update those for the specific camera. If a setting is not supported by the camera an error message will be presented to the user, and the program execution stops.

Error handling

The following recoverable errors can be generated. The errors can be handled in an ERROR handler. The system variable ERRNO will be set to:

Name	Cause of error
ERR_CAM_COM_TIMEOUT	Communication error with camera. The camera is probably disconnected.

Continues on next page

1 Instructions

1.19 CamSetExposure - Set camera specific data

Integrated Vision

Continued

Name	Cause of error
ERR_CAM_NOT_ON_NETWORK	The camera is not connected.

Syntax

```
CamSetExposure
  [ Camera := ] < variable (VAR) of cameradev > ','
  [ '\ExposureTime :=' < variable (IN) of num > ]
  [ '\Brightness :=' < variable (IN) of num > ]
  [ '\Contrast :=' < variable (IN) of num > ] ';'

```

Related information

For information about	See
Integrated Vision	<i>Application manual - Integrated Vision</i>

1.20 CamSetParameter - Set different named camera parameters

Usage

`CamSetParameter` is used to set different named camera parameters that a camera may expose. With this instruction it is possible to change different parameters in the camera in runtime. The user has to know the name of the parameter and its type in order to set its value.

Basic examples

The following example illustrates the instruction `CamSetParameter`.

Example 1

```
CamSetParameter mycamera, "Pattern_1.Tool_Enabled" \BoolVal:=FALSE;  
CamSetRunMode mycamera;
```

In this example the parameter named "Pattern_1.Tool_Enabled" is set to false, which means that the specified vision tool shall not execute when an image is acquired.

This will give a faster execution of the vision tool. However, the tool still produces results with the values from the latest active execution. In order to not use these targets, sort them out in the RAPID program.

Arguments

```
CamSetParameter Camera ParName [\NumVal] | [\BoolVal] | [\StrVal]
```

Camera

Data type: cameradev

The name of the camera.

ParName

Data type: string

The name of the parameter in the camera.

[\NumVal]

Data type: num

The numeric value to set for the camera parameter with the name set in argument ParName.

[\BoolVal]

Data type: bool

The boolean value to set for the camera parameter with the name set in argument ParName.

[\StrVal]

Data type: string

The string value to set for the camera parameter with the name set in argument ParName.

Continues on next page

1 Instructions

1.20 CamSetParameter - Set different named camera parameters

Integrated Vision

Continued

Error handling

The following recoverable errors can be generated. The errors can be handled in an ERROR handler. The system variable `ERRNO` will be set to:

Name	Cause of error
<code>ERR_CAM_BUSY</code>	The camera is busy with some other request and cannot perform the current order.
<code>ERR_CAM_COM_TIMEOUT</code>	Communication error with camera. The camera is probably disconnected.
<code>ERR_CAM_NOT_ON_NETWORK</code>	The camera is not connected.
<code>ERR_CAM_SET_MISMATCH</code>	The parameter written to the camera with instruction <code>CamSetParameter</code> has the wrong data type, or the value is out of range.

Limitations

User created parameters can only be of type `EditString`, `EditInt`, or `EditFloat`.

Syntax

```
CamSetParameter
[ Camera ':' ] < variable (VAR) of cameradev > ','
[ ParName ':' ] < expression (IN) of string >
[ '\NumVal ':' ] < expression (IN) of num > ]
| [ '\BoolVal ':' ] < expression (IN) of bool > ]
| [ '\StrVal ':' ] < expression (IN) of string > ] ';'

```

Related information

For information about	See
Integrated Vision	<i>Application manual - Integrated Vision</i>

1.21 CamSetProgramMode - Orders the camera to go to program mode

Integrated Vision

1.21 CamSetProgramMode - Orders the camera to go to program mode

Usage

CamSetProgramMode (*Camera Set Program Mode*) orders the camera to go to program mode (offline).

Basic examples

The following example illustrates the instruction CamSetProgramMode.

Example 1

```
CamSetProgramMode mycamera;
CamLoadJob mycamera, "myjob.job";
CamSetRunMode mycamera;
...
```

First, change the camera to programming mode. Then load myjob into the camera. Then, order the camera to go to running mode.

Arguments

CamSetProgramMode Camera

Camera

Data type: cameradev

The name of the camera.

Program execution

When ordering a camera to go to program mode with instruction CamSetProgramMode, it will be possible to change settings and load a job into the camera.

Error handling

The following recoverable errors can be generated. The errors can be handled in an ERROR handler. The system variable ERRNO will be set to:

Name	Cause of error
ERR_CAM_BUSY	The camera is busy with some other request and cannot perform the current order.
ERR_CAM_COM_TIMEOUT	Communication error with camera. The camera is probably disconnected.
ERR_CAM_NOT_ON_NETWORK	The camera is not connected.

Syntax

```
CamSetProgramMode
[ Camera ':=' ] < variable (VAR) of cameradev > ';' ;
```

Related information

For information about	See
Integrated Vision	<i>Application manual - Integrated Vision</i>

1 Instructions

1.22 CamSetRunMode - Orders the camera to run mode

Integrated Vision

1.22 CamSetRunMode - Orders the camera to run mode

Usage

`CamSetRunMode` (*Camera Set Running Mode*) orders the camera to go to run mode (online), and updates the controller on the current output to RAPID configuration.

Basic examples

The following example illustrates the instruction `CamSetRunMode`.

Example 1

```
CamSetProgramMode mycamera;  
CamLoadJob mycamera, "myjob.job";  
...  
CamSetRunMode mycamera;
```

First, change the camera to programming mode. Then load `myjob` into the camera. Then, order the camera to go to running mode with instruction `CamSetRunMode`.

Arguments

`CamSetRunMode Camera`

Camera

Data type: `cameradev`

The name of the camera.

Program execution

When ordering a camera to go to run mode with `CamSetRunMode` it is possible to start taking images.

Error handling

The following recoverable errors can be generated. The errors can be handled in an ERROR handler. The system variable `ERRNO` will be set to:

Name	Cause of error
<code>ERR_CAM_BUSY</code>	The camera is busy with some other request and cannot perform the current order.
<code>ERR_CAM_COM_TIMEOUT</code>	Communication error with camera. The camera is probably disconnected.
<code>ERR_CAM_NOT_ON_NETWORK</code>	The camera is not connected.

Syntax

```
CamSetRunMode  
[ Camera ':' = ' ] < variable (VAR) of cameradev > ';' ;
```

Related information

For information about	See
Integrated Vision	<i>Application manual - Integrated Vision</i>

1.23 CamStartLoadJob - Start load of a camera task into a camera

Usage

`CamStartLoadJob` will start the loading of a job into a camera, and then the execution will continue on the next instruction. When loading is in progress other instructions can be executed in parallel.

Basic examples

The following example illustrates the instruction `CamStartLoadJob`.

Example 1

```
...
CamStartLoadJob mycamera, "myjob.job";
MoveL p1, v1000, fine, tool2;
CamWaitLoadJob mycamera;
CamSetRunMode mycamera;
CamReqImage mycamera;
...
```

First a job loading is started to the camera, and while the loading is proceeding, a movement to position `p1` is done. When the movement is ready, and the loading has finished, an image is acquired.

Arguments

`CamStartLoadJob` Camera Name [`\KeepTargets`]

Camera

Data type: `cameradev`

The name of the camera.

Name

Data type: `string`

The name of the job to load into the camera.

[`\KeepTargets`]

Data type: `switch`

This argument is used to specify if old collection data for a specified camera should be kept.

Program execution

Execution of `CamStartLoadJob` will only order the loading and then proceed directly with the next instruction without waiting for the loading to be completed. If optional argument `\KeepTargets` is used, the old collection data for the specified camera is not removed. The default behavior is to remove (flush) old collection data.

The camera will be busy running the load operation and will not accept any new camera requests before the operation is completed with `CamWaitLoadJob`, with the exception that `CamStartSetParameter` requests can be queued.

Continues on next page

1 Instructions

1.23 CamStartLoadJob - Start load of a camera task into a camera

Integrated Vision

Continued

Error handling

The following recoverable errors can be generated. The errors can be handled in an ERROR handler. The system variable `ERRNO` will be set to:

Name	Cause of error
<code>ERR_CAM_BUSY</code>	The camera is busy with some other request and cannot perform the current order.
<code>ERR_CAM_NOT_ON_NETWORK</code>	The camera is not connected

Limitations

It is only possible to execute `CamStartLoadJob` when the camera is set in program mode. Use instruction `CamSetProgramMode` to set the camera in program mode.

When an ongoing load of a job is executing, it is not possible to access that specific camera with any other instruction or function. The following camera instruction or function must be a `CamWaitLoadJob` instruction.

To be able to load the job, the job file must be stored on the camera flash disk.

Syntax

```
CamStartLoadJob
  [ Camera ':= ' ] < variable (VAR) of cameradev > ', '
  [ Name ':= ' ] <expression (IN) of string >
  [ '\KeepTargets ]';
```

Related information

For information about	See
Integrated Vision	<i>Application manual - Integrated Vision</i>
<code>CamWaitLoadJob</code>	CamWaitLoadJob – Wait until a camera task is loaded on page 74
<code>CamStartSetParameter</code>	CamStartSetParameter - Start the set-operation of a parameter setting on page 71

1.24 CamStartSetParameter - Start the set-operation of a parameter setting *Integrated Vision*

1.24 CamStartSetParameter - Start the set-operation of a parameter setting

Usage

`CamStartSetParameter` is used to start the set-operation of a parameter setting in the camera. When the set-operation is in progress other RAPID instructions and functions can be executed in parallel. The camera will be busy running the set parameter-operation and will not perform any other request before this operation is completed with `CamWaitSetParameter`.

Basic examples

The following examples illustrate the instruction `CamStartSetParameter`.

Example 1

```
CamStartSetParameter mycamera, "Pattern_1.Tool_Enabled"
    \BoolVal:=FALSE;
MoveL p1, v1000, fine, tool2;
CamWaitSetParameter mycamera;
```

First a parameter setting is ordered, and while the setting is performed, a movement to position p1 is done. When the movement is ready, and the setting of the parameter is ready, the RAPID execution continues.

Example 2

```
CamStartSetParameter mycamera,
    "Pattern_1.Description"\StrVal:="mydescription";
CamStartSetParameter mycamera,
    "Pattern_1.Rotation_Tolerance"\NumVal:=15;
MoveL p1, v1000, fine, tool2;
CamWaitSetParameter mycamera;
CamWaitSetParameter mycamera;
```

Order two settings of parameters and during the time those are handled a movement is performed. The two `CamStartSetParameter` instructions must be matched with two `CamWaitSetParameter` instructions to be able to perform any other request against the camera.

Arguments

```
CamStartSetParameter Camera ParName [\NumVal] | [\BoolVal] |
    [\StrVal]
```

Camera

Data type: cameradev

The name of the camera.

ParName

Data type: string

The name of the parameter in the camera.

[\NumVal]

Data type: num

Continues on next page

1 Instructions

1.24 CamStartSetParameter - Start the set-operation of a parameter setting

Integrated Vision

Continued

The numeric value to set for the camera parameter with the name set in argument `ParName`.

`[\BoolVal]`

Data type: `bool`

The boolean value to set for the camera parameter with the name set in argument `ParName`.

`[\StrVal]`

Data type: `string`

The string value to set for the camera parameter with the name set in argument `ParName`.

Program execution

`CamStartSetParameter` will start the set-operation of a parameter in the camera. When the set operation is in progress, other RAPID instructions and functions can be executed in parallel.

The camera will be busy running the set parameter operation and will not perform any other request before this operation is completed with `CamWaitSetParameter`. Every `CamStartSetParameter` instruction must be matched with a corresponding `CamWaitSetParameter` instruction.

With multiple queued `StartSetParameter` requests, then the corresponding `WaitSetParameter` will reflect the same order as the for the request and thus return the status for that `StartSetParameter`.



Note

User defined parameters in the camera have to be associated with one of the following camera functions:

- `EditFloat`
- `EditInt`
- `EditString`

Error handling

The following recoverable errors are generated and can be handled in an error handler. The system variable `ERRNO` will be set to:

<code>ERR_CAM_BUSY</code>	The camera is busy with some other request and cannot perform the current order.
<code>ERR_CAM_NOT_ON_NETWORK</code>	The camera is not connected.
<code>ERR_CAM_NO_PROGMODE</code>	The camera is not in program mode.

Limitations

The controller can have 10 pending `CamStartSetParameter` operations. When the controller has 10 pending requests, all the requests have to be confirmed with `CamWaitSetParameter` instructions before any new `CamStartSetParameter` is ordered.

Continues on next page

1.24 CamStartSetParameter - Start the set-operation of a parameter setting

Integrated Vision
Continued

Syntax

```
CamStartSetParameter
  [ Camera ':= ' ] < variable (VAR) of cameradev > ','
  [ ParName ':= ' ] < expression (IN) of string >
  [ '\NumVal ':= ' < expression (IN) of num > ]
  | [ '\BoolVal ':= ' < expression (IN) of bool > ]
  | [ '\StrVal ':= ' < expression (IN) of string > ] ';'

```

Related information

For information about	See
Integrated Vision	<i>Application manual - Integrated Vision</i>
CamWaitSetParameter	CamWaitSetParameter - Wait until a set-operation is ready on page 76
CamSetParameter	CamSetParameter - Set different named camera parameters on page 65

1 Instructions

1.25 CamWaitLoadJob – Wait until a camera task is loaded

Integrated Vision

1.25 CamWaitLoadJob – Wait until a camera task is loaded

Usage

CamWaitLoadJob (*Camera Wait Load Job*) will wait until the loading of a job into a camera is ready.

Basic examples

The following example illustrates the instruction CamWaitLoadJob.

Example 1

```
...
CamStartLoadJob mycamera, "myjob.job";
MoveL p1, v1000, fine, tool2;
CamWaitLoadJob mycamera;
CamSetRunMode mycamera;
CamReqImage mycamera;
...
```

First a job loading is started to the camera, and while the loading is proceeding, a movement to position p1 is done. When the movement is ready, and the loading has finished, an image is acquired.

Arguments

CamWaitLoadJob Camera

Camera

Data type: cameradev

The name of the camera.

Error handling

The following recoverable errors can be generated. The errors can be handled in an ERROR handler. The system variable ERRNO will be set to:

Name	Cause of error
ERR_CAM_COM_TIMEOUT	Communication error with camera. The camera is probably disconnected.
ERR_CAM_NOT_ON_NETWORK	The camera is not connected

Limitations

It is only possible to execute CamWaitLoadJob when the camera is set in program mode. Use instruction CamSetProgramMode to set the camera in program mode. When an ongoing load of a job is executing, it is not possible to access that specific camera with any other instruction or function. The following camera instruction or function must be a CamWaitLoadJob instruction.

Syntax

```
CamWaitLoadJob
[ Camera ':= ' ] < variable (VAR) of cameradev > ' ; '
```

Continues on next page

1.25 CamWaitLoadJob – Wait until a camera task is loaded

Integrated Vision

Continued

Related information

For information about	See
Integrated Vision	<i>Application manual - Integrated Vision</i>
CamStartLoadJob	CamStartLoadJob - Start load of a camera task into a camera on page 69

1 Instructions

1.26 CamWaitSetParameter - Wait until a set-operation is ready

Integrated Vision

1.26 CamWaitSetParameter - Wait until a set-operation is ready

Usage

`CamWaitSetParameter` will wait until the set-operation of the parameter is done in the camera and return with status.

Basic examples

The following example illustrates the instruction `CamWaitSetParameter`.

Example 1

```
CamStartSetParameter mycamera, "Pattern_1.Tool_Enabled"  
    \BoolVal:=FALSE;  
MoveL p1, v1000, fine, tool2;  
CamWaitSetParameter mycamera;
```

First a parameter setting is ordered, and while the setting is performed, a movement to position p1 is done. When the movement is ready, and the setting of the parameter is ready, the RAPID execution continues.

Arguments

`CamWaitSetParameter` Camera

Camera

Data type: cameradev

The name of the camera.

Error handling

The following recoverable errors are generated and can be handled in an error handler. The system variable `ERRNO` will be set to:

<code>ERR_CAM_BUSY</code>	The camera is busy with some other request and cannot perform the current order.
<code>ERR_CAM_COM_TIMEOUT</code>	Communication error with camera. The camera is probably disconnected.
<code>ERR_CAM_NOT_ON_NETWORK</code>	The camera is not connected.
<code>ERR_CAM_NO_START_SET_PARAMETER</code>	There is no ongoing request to set a parameter to camera.
<code>ERR_CAM_SET_MISMATCH</code>	The parameter written to the camera with instruction <code>CamSetParameter</code> has the wrong datatype, or the value is out of range.
<code>ERR_CAM_SET_PARAMETER_REJECTED</code>	The preceding instruction failed and also caused the setting of parameter to fail for the camera.

Syntax

```
CamWaitSetParameter  
    [ Camera '=' ] < variable (VAR) of cameradev > ';' ;
```

Related information

For information about	See
Integrated Vision	<i>Application manual - Integrated Vision</i>

Continues on next page

1.26 CamWaitSetParameter - Wait until a set-operation is ready

Integrated Vision

Continued

For information about	See
CamStartSetParameter	CamStartSetParameter - Start the set-operation of a parameter setting on page 71

1 Instructions

1.27 CancelLoad - Cancel loading of a module *RobotWare Base*

1.27 CancelLoad - Cancel loading of a module

Usage

CancelLoad can be used to cancel the loading operation generated from the instruction StartLoad.

CancelLoad can only be used between the instruction StartLoad and WaitLoad.

Basic examples

The following example illustrates the instruction CancelLoad:

See also [More examples on page 78](#).

Example1

```
CancelLoad load1;
```

The load session load1 is cancelled.

Arguments

```
CancelLoad LoadNo
```

LoadNo

Data type: loadsession

Reference to the load session, created by the instruction StartLoad.

Error handling

The following recoverable errors can be generated. The errors can be handled in an ERROR handler. The system variable ERRNO will be set to:

Name	Cause of error
ERR_LOADNO_NOUSE	The variable specified in argument LoadNo is not in use, meaning that no load session is in use.

More examples

More examples of how to use the instruction CancelLoad are illustrated below.

Example 1

```
VAR loadsession load1;

StartLoad "HOME:\File:="PART_B.MOD",load1;
...
IF ...
  CancelLoad load1;
  StartLoad "HOME:\File:="PART_C.MOD",load1;
ENDIF
...
WaitLoad load1;
```

The instruction CancelLoad will cancel the on-going loading of the module PART_B.MOD and instead make it possible to load PART_C.MOD.

Continues on next page

Limitation

CancelLoad can only be used in the sequence after that instruction StartLoad is ready and before instruction WaitLoad is started.

Syntax

```
CancelLoad
  [ LoadNo ':= ' ] < variable (VAR) of loadsession >';'
```

Related information

For information about	See
Load a program module during execution	StartLoad - Load a program module during execution on page 787
Connect the loaded module to the task	WaitLoad - Connect the loaded module to the task on page 1061
Load session	loadsession - Program load session on page 1689
Load a program module	Load - Load a program module during execution on page 342
Unload a program module	UnLoad - Unload a program module during execution on page 1010
Check program references	CheckProgRef - Check program references on page 130

1 Instructions

1.28 CapAPTrSetup - Set up an At-Point-Tracker *Continuous Application Platform (CAP)*

1.28 CapAPTrSetup - Set up an At-Point-Tracker

Usage

CapAPTrSetup (*Set up an At-Point-Tracker*) is used to set up an At-Point-Tracker type of sensor, for example, *WeldGuide* or *AWC*.

The controller communicates with the sensors over serial or ethernet channels using one of the supported transport protocols (RTP1, SOCKETDEV or LTAPPTCP).

Basic example

SIO.cfg:

```
COM_TRP:
  -Name "wg:" -Type "SOCKETDEV" -RemoteAddress "192.168.1255.101"
  -RemotePort "6344"
```

RAPID code:

```
! Define variable numbers
CONST num SensorOn := 6;
CONST num XCoord := 8;
CONST num YCoord := 9;
CONST num ZCoord := 10;
VAR pos SensorPos;

! Setup a Weldguide
CapAPTrSetup "wg:", do_left, 80, do_right, 80;
```

Arguments

```
CapAPTrSetup device DoLeft LevelLeft DoRight LevelRight [\LogFile]
[\LogSize]
```

device

Data type: string

The I/O device name configured in sio.cfg for the sensor used.

DoLeft

Data type: signaldo

Digital output signal for weave synchronization on the left weave cycle.

LevelLeft

Data type: num

The coordination position on the left side of the weaving pattern. The value specified is a percentage of the width on the left of the weaving center. When weaving is carried out beyond this point, a digital output signal is automatically set high (provided the signal is defined).

Continues on next page

This type of coordination can be used for seam tracking using Through-the-Arc Tracker.

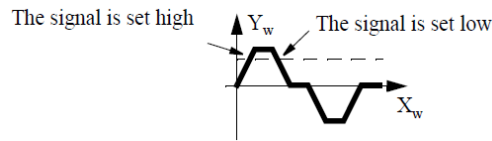

xx120000178

DoRight

Data type: `signaldo`

Digital output signal for weave synchronization on the right weave cycle.

LevelRight

Data type: `num`

The coordination position on the right side of the weaving pattern. The value specified is a percentage of the width on the right of the weaving center. When weaving is carried out beyond this point, a digital output signal is automatically set high (provided the signal is defined).

This type of coordination can be used for seam tracking using Through-the-Arc Tracker.

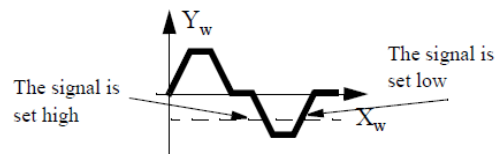

xx120000179

[LogFile]

Data type: `string`

Name of tracklog log file.

[LogSize]

Data type: `num`

Size of the tracklog ring buffer, that is the number of sensor measurements that can be buffered during tracking.

Default value: 1000.

Syntax

```
CapAPTrSetup
[device ':='] < expression (IN) of string > ','
[DoLeft ':='] < expression (IN) of signaldo > ','
[LevelLeft ':='] < expression (IN) of num > ','
[DoRight ':='] < expression (IN) of signaldo > ','
[LevelRight ':='] < expression (IN) of num >
['\LogFile ':='] < expression (IN) of string >
['\LogSize ':='] < expression (IN) of num > ';'

```

Continues on next page

1 Instructions

1.28 CapAPTrSetup - Set up an At-Point-Tracker

Continuous Application Platform (CAP)

Continued

Related information

	Described in:
<i>Continuous Application Platform</i>	<i>Application manual - Continuous Application Platform</i>
<i>Sensor Interface</i>	<i>Application manual - Controller software IRC5</i>

1.29 CapAPTrSetupAI - Setup an At-Point-Tracker controlled by analog input signals Continuous Application Platform (CAP)

1.29 CapAPTrSetupAI - Setup an At-Point-Tracker controlled by analog input signals

Usage

CapAPTrSetupAI is used to setup an At-Point-Tracker controlled by analog input signals.

Basic examples

The following example illustrates the instruction CapAPTrSetupAI.

Example 1

```
TASK PERS capdata cData:=[.....];
TASK PERS weavestartdata wsData:=[.....];
TASK PERS capweavedata wData:=[.....];
TASK PERS captrackdata trackData:=["ANALOG_TRACKER",.....];

VAR capaptrreferencedata referenceData:=[2,2,1,1,0.1,0.1];
VAR signalai ai_y;
VAR signalai ai_z;

AliasIO realsignal_y, ai_y;
AliasIO realsignal_z, ai_z;
CapAPTrSetupAI ai_y, ai_z, referenceData;

CapL p1, v200, cData, wsData, wData , fine, tWeldGun
  \Track:=trackData;
```

Arguments

```
CapAPTrSetupAI ai_y, ai_z, ReferenceData [\MaxIncrCorr]
  [\WarnMaxCorr] [\Filter] [\SampleTime] [\Logfile] [\LogSize]
  [\LatestCorr] [\AccCorr]
```

ai_y

Data type: signalai

Analog input signal used as process position for the y-direction.

ai_z

Data type: signalai

Analog input signal used as process position for the z-direction.

ReferenceData

Data type: capaptrreferencedata

Setup data used for the correction regulator loop.

MaxIncrCorr

Data type: num

Maximum incremental correction allowed (in mm).

If the incremental TCP correction is larger than \MaxIncrCorr and \WarnMaxCorr, the robot will continue its path but the applied incremental correction will not exceed

Continues on next page

1 Instructions

1.29 CapAPTrSetupAI - Setup an At-Point-Tracker controlled by analog input signals

Continuous Application Platform (CAP)

Continued

`\MaxIncCorr`. If `\WarnMaxCorr` is not specified, a track error is reported and the program execution is stopped.

`WarnMaxCorr`

Data type: `switch`

If this switch is present the program execution is not interrupted when the limit for maximum correction is exceeded, specified in `\MaxIncCorr`. Only a warning is sent.

`Filter`

Data type: `num`

Size of the reference sample data filter. A value between 1 and 15 is allowed, the default value is 1.

`SampleTime`

Data type: `num`

Sample time in milliseconds for the correction loop. The value is rounded to a multiple of 24. The minimum value allowed is 24, and the default value is 24.

`LogFile`

Data type: `string`

The name of the tracklog log file. The log file is placed in the HOME directory of the system.

`LogSize`

Data type: `num`

The size of the tracklog ring buffer that is the number of sensor measurements that can be buffered during tracking.

Default value: 1000.

`LatestCorr`

Data type: `pos`

Size of the latest added correction (in mm).

`AccCorr`

Data type: `pos`

Size of the total accumulated correction added (in mm).

Syntax

```
CapAPTrSetupAI
  [aoi_y ':=' ] <expression (IN) of signalai> ', '
  [ai_z ':=' ] <expression (IN) of signalai> ', '
  [ReferenceData ':=' ] <expression (IN) of capaptrreferencedata>
  ', '
  [\MaxIncrCorr ':=' ] <expression (IN) of num> ', '
  [\WarnMaxCorr ':=' ] <expression (IN) of switch> ', '
  [\Filter ':=' ] <expression (IN) of num> ', '
  [\SampleTime ':=' ] <expression (IN) of num> ', '
  [\LogFile ':=' ] <expression (IN) of string> ', '
  '
```

Continues on next page

1.29 CapAPTrSetupAI - Setup an At-Point-Tracker controlled by analog input signals Continuous Application Platform (CAP)

Continued

```
[\LogSize ':='] <expression (IN) of num> ','
[\LatestCorr ':='] <expression (PERS) of pos> ','
[\AccCorr ':='] <expression (PERS) of pos> ';'

```

Related information

For information about	See
Instruction CapAPTrSetupAO	CapAPTrSetupAO - Setup an At-Point-Tracker controlled by analog output signals on page 86
Instruction CapAPTrSetupPERS	CapAPTrSetupPERS - Setup an At-Point-Tracker controlled by persistent variables on page 89
Data type capaptrreferencedata	capaptrreferencedata - Variable setup data for At-Point-Tracker on page 1612
<i>Continuous Application Platform</i>	<i>Application manual - Continuous Application Platform</i>
<i>Sensor Interface</i>	<i>Application manual - Controller software IRC5</i>

1 Instructions

1.30 CapAPTrSetupAO - Setup an At-Point-Tracker controlled by analog output signals *Continuous Application Platform (CAP)*

1.30 CapAPTrSetupAO - Setup an At-Point-Tracker controlled by analog output signals

Usage

CapAPTrSetupAO is used to setup an At-Point-Tracker controlled by analog output signals.

Basic examples

The following example illustrates the instruction CapAPTrSetupAO.

Example 1

```
TASK PERS capdata cData:=[.....];
TASK PERS weavestartdata wsData:=[.....];
TASK PERS capweavedata wData:=[.....];
TASK PERS captrackdata trackData:["ANALOG_TRACKER",.....];

VAR capaptrreferencedata referenceData:=[2,2,1,1,0.1,0.1];
VAR signalao ao_y;
VAR signalao ao_z;

AliasIO realsignal_y, ao_y;
AliasIO realsignal_z, ao_z;
CapAPTrSetupAO ao_y, ao_z, referenceData;

CapL p1, v200, cData, wsData, wData , fine, tWeldGun
  \Track:=trackData;
```

Arguments

```
CapAPTrSetupAO ao_y, ao_z, ReferenceData [\MaxIncrCorr]
  [\WarnMaxCorr] [\Filter] [\SampleTime] [\Logfile] [\LogSize]
  [\LatestCorr] [\AccCorr]
```

ao_y

Data type: signalao

Analog output signal used as process position for the y-direction.

ao_z

Data type: signalao

Analog output signal used as process position for the z-direction.

ReferenceData

Data type: capaptrreferencedata

Setup data used for the correction regulator loop.

MaxIncrCorr

Data type: num

Maximum incremental correction allowed (in mm).

If the incremental TCP correction is larger than \MaxIncrCorr and \WarnMaxCorr, the robot will continue its path but the applied incremental correction will not exceed

Continues on next page

1.30 CapAPTrSetupAO - Setup an At-Point-Tracker controlled by analog output signals Continuous Application Platform (CAP)

Continued

`\MaxIncCorr`. If `\WarnMaxCorr` is not specified, a track error is reported and the program execution is stopped.

`WarnMaxCorr`

Data type: `switch`

If this switch is present the program execution is not interrupted when the limit for maximum correction is exceeded, specified in `\MaxIncCorr`. Only a warning is sent.

`Filter`

Data type: `num`

Size of the reference sample data filter. A value between 1 and 15 is allowed, the default value is 1.

`SampleTime`

Data type: `num`

Sample time in milliseconds for the correction loop. The value is rounded to a multiple of 24. The minimum value allowed is 24, and the default value is 24.

`LogFile`

Data type: `string`

The name of the tracklog log file. The log file is placed in the HOME directory of the system.

`LogSize`

Data type: `num`

The size of the tracklog ring buffer that is the number of sensor measurements that can be buffered during tracking.

Default value: 1000.

`LatestCorr`

Data type: `pos`

Size of the latest added correction (in mm).

`AccCorr`

Data type: `pos`

Size of the total accumulated correction added (in mm).

Syntax

```
CapAPTrSetupAO
  [ao_y ':=' ] <expression (IN) of signalao> ','
  [ao_z ':=' ] <expression (IN) of signalao> ','
  [ReferenceData ':=' ] <expression (IN) of capaptrreferencedata>
  ','
  [\MaxIncrCorr ':=' ] <expression (IN) of num> ','
  [\WarnMaxCorr ':=' ] <expression (IN) of switch> ','
  [\Filter ':=' ] <expression (IN) of num> ','
  [\SampleTime ':=' ] <expression (IN) of num> ','
  [\LogFile ':=' ] <expression (IN) of string> ','
```

Continues on next page

1 Instructions

1.30 CapAPTrSetupAO - Setup an At-Point-Tracker controlled by analog output signals

Continuous Application Platform (CAP)

Continued

```
[\LogSize ':='] <expression (IN) of num> ','  
[\LatestCorr ':='] <expression (PERS) of pos> ','  
[\AccCorr ':='] <expression (PERS) of pos> ';'
```

Related information

For information about	See
Instruction CapAPTrSetupAI	CapAPTrSetupAI - Setup an At-Point-Tracker controlled by analog input signals on page 83
Instruction CapAPTrSetupPERS	CapAPTrSetupPERS - Setup an At-Point-Tracker controlled by persistent variables on page 89
Data type capaptrreferencedata	capaptrreferencedata - Variable setup data for At-Point-Tracker on page 1612
<i>Continuous Application Platform</i>	<i>Application manual - Continuous Application Platform</i>
<i>Sensor Interface</i>	<i>Application manual - Controller software IRC5</i>

1.31 CapAPTrSetupPERS - Setup an At-Point-Tracker controlled by persistent variables Continuous Application Platform (CAP)

1.31 CapAPTrSetupPERS - Setup an At-Point-Tracker controlled by persistent variables

Usage

CapAPTrSetupPERS is used to setup an At-Point-Tracker controlled by persistent variables.

Basic examples

The following example illustrates the instruction CapAPTrSetupPERS.

Example 1

```
TASK PERS capdata cData:=[.....];
TASK PERS weavestartdata wsData:=[.....];
TASK PERS capweavedata wData:=[.....];
TASK PERS captrackdata trackData:=["ANALOG_TRACKER",.....];
PERS pos corr:=[0,-0.05,-0.025];

VAR capaptrreferencedata referenceData:=[2,2,1,1,0.1,0.1];

main()
IDelete intnol;
CONNECT intnol WITH trOffset;
CapAPTRSetupPERS corr.y, corr.z, referenceData;

ITimer 1,intnol;
CapL pl, v200, cData, wsData, wData , fine,
    tWeldGun\Track:=trackData;
ENDPROC

TRAP trOffset
    corr.y := referenceData.reference_y +- .....;
    corr.z := referenceData.reference_z +- .....;
ENDTRAP
```

Arguments

```
CapAPTrSetupPERS var_y, var_z, ReferenceData [\ResetToReference]
[\MaxIncrCorr] [\WarnMaxCorr] [\Filter] [\SampleTime]
[\Logfile] [\LogSize] [\LatestCorr] [\AccCorr]
```

var_y

Data type: num

Persistent data used as process position for the y-direction.

var_z

Data type: signalai

Persistent data used as process position for the z-direction.

ReferenceData

Data type: capaptrreferencedata

Setup data used for the correction regulator loop.

Continues on next page

1 Instructions

1.31 CapAPTrSetupPERS - Setup an At-Point-Tracker controlled by persistent variables

Continuous Application Platform (CAP)

Continued

`[\ResetToReference]`

Data type: `switch`

This switch enables resetting the value of the persistent correction data `var_y` and `var_z` to the reference value. If `var_y` and `var_z` are updated at low frequency, for example, using RAPID code, this switch is used to avoid drifting of the path correction.

`MaxIncCorr`

Data type: `num`

Maximum incremental correction allowed (in mm).

If the incremental TCP correction is larger than `\MaxIncCorr` and `\WarnMaxCorr`, the robot will continue its path but the applied incremental correction will not exceed `\MaxIncCorr`. If `\WarnMaxCorr` is not specified, a track error is reported and the program execution is stopped.

`WarnMaxCorr`

Data type: `switch`

If this switch is present the program execution is not interrupted when the limit for maximum correction is exceeded, specified in `\MaxIncCorr`. Only a warning is sent.

`Filter`

Data type: `num`

Size of the reference sample data filter. A value between 1 and 15 is allowed, the default value is 1.

`SampleTime`

Data type: `num`

Sample time in milliseconds for the correction loop. The value is rounded to a multiple of 24. The minimum value allowed is 24, and the default value is 24.

`LogFile`

Data type: `string`

The name of the tracklog log file. The log file is placed in the HOME directory of the system.

`LogSize`

Data type: `num`

The size of the tracklog ring buffer that is the number of sensor measurements that can be buffered during tracking.

Default value: 1000.

`LatestCorr`

Data type: `pos`

Size of the latest added correction (in mm).

`AccCorr`

Data type: `pos`

Continues on next page

1.31 CapAPTrSetupPERS - Setup an At-Point-Tracker controlled by persistent variables Continuous Application Platform (CAP)

Continued

Size of the total accumulated correction added (in mm).

Syntax

```

CapAPTrSetupPERS
[var_y ':='] <expression (PERS) of num> ','
[var_z ':='] <expression (PERS) of vnum> ','
[ReferenceData ':='] <expression (IN) of capaptrreferencedata>
','
[\ResetToReference ':='] <expression (IN) of switch> ','
[\MaxIncrCorr ':='] <expression (IN) of num> ','
[\WarnMaxCorr ':='] <expression (IN) of switch> ','
[\Filter ':='] <expression (IN) of num> ','
[\SampleTime ':='] <expression (IN) of num> ','
[\LogFile ':='] <expression (IN) of string> ','
[\LogSize ':='] <expression (IN) of num> ','
[\LatestCorr ':='] <expression (PERS) of pos> ','
[\AccCorr ':='] <expression (PERS) of pos> ';'

```

Related information

For information about	See
Instruction CapAPTrSetupAI	CapAPTrSetupAI - Setup an At-Point-Tracker controlled by analog input signals on page 83
Instruction CapAPTrSetupAO	CapAPTrSetupAO - Setup an At-Point-Tracker controlled by analog output signals on page 86
Data type capaptrreferencedata	capaptrreferencedata - Variable setup data for At-Point-Tracker on page 1612
Continuous Application Platform	Application manual - Continuous Application Platform
Sensor Interface	Application manual - Controller software IRC5

1 Instructions

1.32 CapC - Circular CAP movement instruction Continuous Application Platform (CAP)

1.32 CapC - Circular CAP movement instruction

Usage

CapC is used to move the tool center point (TCP) along a circular path to a given destination and at the same time control a continuous process. Furthermore it is possible to connect up to eight events to CapC. The events are defined using the instructions TriggRampAO, TriggIO, TriggEquip, TriggInt, TriggCheckIO, or TriggSpeed.

Basic examples

Example 1

Circular movements with CapC.

```
CapC cirp, p1, v100, cdata, weavestart, weave, fine, gun1;
```

The TCP of the tool, gun1, is moved circularly to the fine point p1 with speed defined in cdata.

Example 2

Circular movement with user event and CAP event.

```
VAR intnum start_intno;
...
PROC main()
  VAR triggdata gunon;

  IDelete start_intno;
  CONNECT start_intno WITH start_trap;
  ICap start_intno, CAP_START;
  TriggIO gunon, 0 \Start \DOp:=gun, on;

  MoveJ p1, v500, z50, gun1;
  CapC p2,p3,v500,cdata,wstart,w1,fine,gun1,\T1:=gunon;
ENDPROC

TRAP start_trap
  ! This routine will be executed when the event CAP_START is
  reported
ENDTRAP
```

The digital output signal gun is set when the robot's TCP passes the midpoint of the corner path of the point p1. The trap routine start_trap is executed when the CAP process is starting.

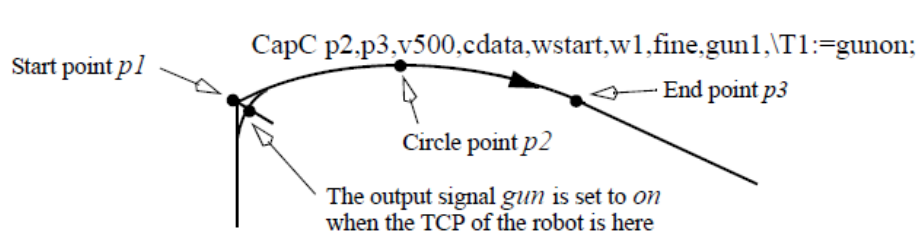

xx1200000174

Continues on next page

Arguments

```
CapC Cirpoint ToPoint [\ID] Speed Cdata [\MoveStartTimer] Weavestart  
Weave Zone [\Inpos] Tool [\WObj] [\Track] | [\Corr]  
[\PreProcessTracking] [\Time] [\T1] [\T2] [\T3] [\T4] [\T5]  
[\T6] [\T7] [\T8] [\TLoad]
```

CirPoint

Data type: robtarget

The circle point of the robot. The circle point is a position on the circle between the start point and the destination point. To obtain the best accuracy it should be placed about halfway between the start and destination points. If it is placed too close to the start or destination point, the robot may give a warning. The circle point is defined as a named position or stored directly in the instruction (marked with an * in the instruction). The position of the external axes are not used.

ToPoint

Data type: robtarget

The destination point of the robot and external axes. It is defined as a named position or stored directly in the instruction (marked with an * in the instruction).

[\ID]

Synchronization id

Data type: identno

The argument [\ID] is mandatory in MultiMove systems, if the movement is synchronized or coordinated synchronized. This argument is not allowed in any other case. The specified id number must be the same in all the cooperating program tasks. By using the id number the movements are not mixed up at the runtime.

Speed

Data type: speeddata

The speed data that applies to movements. Speed data defines the velocity of the TCP, the tool reorientation, and external axes.

Cdata

(CAP process Data)

Data type: capdata

CAP process data, see [capdata - CAP data on page 1614](#) for a detailed description.

[\Movestart_timer]

(Time in s)

Data type: num

Upper limit for the time difference between the order of the process start and the actual start of the robot's TCP movement in a MultiMove system in synchronized mode.

Weavestart

(Weavestart Data)

Continues on next page

1 Instructions

1.32 CapC - Circular CAP movement instruction

Continuous Application Platform (CAP)

Continued

Data type: weavestartdata

Weave start data for the CAP process, see [weavestartdata - weave start data on page 1801](#) for a detailed description.

Weave

(Weave Data)

Data type: capweavedata

Weaving data for the CAP process, see [capweavedata - Weavedata for CAP on page 1628](#) for a detailed description.

Zone

Data type: zonedata

Zone data for the movement. Zone data describes the size of the generated corner path.

[\Inpos]

In position

Data type: stoppoint data

This argument is used to specify the convergence criteria for the position of the robot's TCP in the stop point. The stop point data substitutes the zone specified in the `Zone` parameter.

Tool

Data type: tooldata

The tool in use when the robot moves. The tool center point is the point that is moved to the specified destination point.

[\WObj]

Work Object

Data type: wobjdata

The work object (object coordinate system) to which the robot position in the instruction is related.

This argument can be omitted and if it is then the position is related to the world coordinate system. If, on the other hand, a stationary TCP or coordinated external axes are used this argument must be specified in order for a circle relative to the work object to be executed.

[\Track]

(Track Sensor Data)

Data type: captrackdata

This data structure contains data needed for use of path correction generating sensors together with `CapC`, see [captrackdata - CAP track data on page 1625](#). This argument is not allowed together with the argument `\Corr`.

[\Corr]

Correction

Data type: switch

Continues on next page

Correction data written to a corrections entry by the instruction `CorrWrite` will be added to the path and destination position if this argument is present.

The RobotWare option *Path Offset* is required when using this argument.

[`\PreProcessTracking`]

Data type: switch

This argument is effective only if `first_instruction` is set to `TRUE` and the `\Track` argument is present.

This argument activates *Pre Process Tracking*, which means that the robot will be tracking only, without process, during that CapX instruction. Thereby sensor data are available for successful tracking right off the start of the path with process, e.g. welding.

For more information see *Operating manual - Tracking and searching with optical sensors*.

[`\Time`]

Data type: num

This argument is used to specify the total time in seconds during which the robot and additional axes move. It is then substituted for the corresponding speed data.

[`\T1`]

Trigg 1

Data type: triggdata

Variable that refers to trigger conditions and trigger activity defined earlier in the program using the instructions `TriggIO`, `TriggEquip`, `TriggInt`, `TriggCheckIO`, `TriggSpeed`, or `TriggRampAO`.

[`\T2`]

Trigg 2

Data type: triggdata

Variable that refers to trigger conditions and trigger activity defined earlier in the program using the instructions `TriggIO`, `TriggEquip`, `TriggInt`, `TriggCheckIO`, `TriggSpeed`, or `TriggRampAO`.

[`\T3`]

Trigg 3

Data type: triggdata

Variable that refers to trigger conditions and trigger activity defined earlier in the program using the instructions `TriggIO`, `TriggEquip`, `TriggInt`, `TriggCheckIO`, `TriggSpeed`, or `TriggRampAO`.

[`\T4`]

Trigg 4

Data type: triggdata

Variable that refers to trigger conditions and trigger activity defined earlier in the program using the instructions `TriggIO`, `TriggEquip`, `TriggInt`, `TriggCheckIO`, `TriggSpeed`, or `TriggRampAO`.

Continues on next page

1 Instructions

1.32 CapC - Circular CAP movement instruction

Continuous Application Platform (CAP)

Continued

[\T5]

Trigg 5

Data type: triggdata

Variable that refers to trigger conditions and trigger activity defined earlier in the program using the instructions `TriggIO`, `TriggEquip`, `TriggInt`, `TriggCheckIO`, `TriggSpeed`, or `TriggRampAO`.

[\T6]

Trigg 6

Data type: triggdata

Variable that refers to trigger conditions and trigger activity defined earlier in the program using the instructions `TriggIO`, `TriggEquip`, `TriggInt`, `TriggCheckIO`, `TriggSpeed`, or `TriggRampAO`.

[\T8]

Trigg 8

Data type: triggdata

Variable that refers to trigger conditions and trigger activity defined earlier in the program using the instructions `TriggIO`, `TriggEquip`, `TriggInt`, `TriggCheckIO`, `TriggSpeed`, or `TriggRampAO`.

[\T8]

Trigg 8

Data type: triggdata

Variable that refers to trigger conditions and trigger activity defined earlier in the program using the instructions `TriggIO`, `TriggEquip`, `TriggInt`, `TriggCheckIO`, `TriggSpeed`, or `TriggRampAO`.

[\TLoad]

Total load

Data type: loaddata

The `\TLoad` argument describes the total load used in the movement. The total load is the tool load together with the payload that the tool is carrying. If the `\TLoad` argument is used, then the `loaddata` in the current `tooldata` is not considered.

If the `\TLoad` argument is set to `load0`, then the `\TLoad` argument is not considered and the `loaddata` in the current `tooldata` is used instead.

To be able to use the `\TLoad` argument it is necessary to set the value of the system parameter `ModalPayLoadMode` to 0. If `ModalPayLoadMode` is set to 0, it is no longer possible to use the instruction `GripLoad`.

The total load can be identified with the service routine `LoadIdentify`. If the system parameter `ModalPayLoadMode` is set to 0, the operator has the possibility to copy the `loaddata` from the tool to an existing or new `loaddata` persistent variable when running the service routine.

It is possible to test run the program without any payload by using a digital input signal connected to the system input `SimMode` (Simulated Mode). If the digital

Continues on next page

input signal is set to 1, the `loaddata` in the optional argument `\TLoad` is not considered, and the `loaddata` in the current `tooldata` is used instead.



Note

The default functionality to handle payload is to use the instruction `GripLoad`. Therefore the default value of the system parameter `ModalPayloadMode` is 1.

Program execution

See [MoveL - Moves the robot linearly on page 458](#) for information about linear movement.

See [TriggL - Linear robot movements with events on page 935](#) for information about linear movement with trigg events.

Error handling

There are several different types of errors that can be handled in the error handler for the `CapC/CapL` instructions:

- supervision errors
- sensor specific errors
- errors specific to a MultiMove system
- errors inherited from `TriggX` functionality
- other CAP errors

If one of the signals that is supposed to be supervised does not have the correct value, or if it changes value during supervision, the system variable `ERRNO` is set.

If no values can be read from the track sensor, the system variable `ERRNO` is set.

For a MultiMove system running in synchronized mode the error handler must take care of two other errors. One is used to report that some other application has detected a recoverable error. This enables recoverable error handling in synchronized RAPID tasks. The other error, `CAP_MOV_WATCHDOG`, is reported if the time between the order of the process start and the actual start of the robot's TCP movement in a MultiMove system in synchronized mode expires. The time used is specified in the optional parameter `Movestart_timer` in the `CapC` instruction.

If anything abnormal is detected, program execution will stop. If, however, an error handler is programmed, the errors defined below can be remedied without stopping production. However, a recommendation is that some of the errors (the errors with `CAP_XX`) these errors should not be presented for the end user. Map those errors

Continues on next page

1 Instructions

1.32 CapC - Circular CAP movement instruction

Continuous Application Platform (CAP)

Continued

to a application specific error. For the supervision errors the instruction `CapGetFailSigs` can be used to get which specific signal that failed.

Supervision errors

The following recoverable errors are generated and can be handled in an error handler. The system variable `ERRNO` will be set to:

<code>CAP_PRE_ERR</code>	This error occurs when there is an error in the <code>PRE</code> supervision list, that is, when the conditions in the list are not met within the specified time frame (specified in <code>pre_cond</code> time-out).
<code>CAP_PRESTART_ERR</code>	This error occurs when there is an error during the supervision of the <code>PRESTART</code> phase.
<code>CAP_END_PRE_ERR</code>	This event occurs when there is an error in the <code>END_PRE</code> supervision list, that is, when the conditions in the list are not met within the specified time frame (specified in <code>start_cond</code> time-out).
<code>CAP_START_ERR</code>	This event occurs when there is an error in the <code>START</code> supervision list, that is, when the conditions in the list are not met within the specified time frame (specified in <code>start_cond</code> time-out).
<code>CAP_MAIN_ERR</code>	This error occurs when there is an error during the supervision of the <code>MAIN</code> phase.
<code>CAP_ENDMAIN_ERR</code>	This error occurs when there is an error in the <code>END_MAIN</code> supervision list, that is, when the conditions in the list are not met within the specified time frame (specified in <code>end_main_cond</code> time-out).
<code>CAP_START_POST1_ERR</code>	This event occurs when there is an error in the <code>START_POST1</code> supervision list, that is, when the conditions in the list are not met within the specified time frame (specified in <code>end_main_cond</code> time-out).
<code>CAP_POST1_ERR</code>	This error occurs when there is an error during the supervision of the <code>POST1</code> phase.
<code>CAP_POST1END_ERR</code>	This error occurs when there is an error in the <code>END_POST1</code> supervision list, that is, when the conditions in the list are not met within the specified time frame (specified in <code>end_main_cond</code> time-out).
<code>CAP_START_POST2_ERR</code>	This event occurs when there is an error in the <code>START_POST2</code> supervision list, that is, when the conditions in the list are not met within the specified time frame (specified in <code>end_main_cond</code> time-out).
<code>CAP_POST2_ERR</code>	This error occurs when there is an error during the supervision of the <code>POST2</code> phase.
<code>CAP_POST2END_ERR</code>	This error occurs when there is an error in the <code>END_POST2</code> supervision list, that is, when the conditions in the list are not met within the specified time frame (specified in <code>end_main_cond</code> time-out). If supervision is done on two different signals in the same phase, and both of them fails, the first one that is setup with <code>SetupSuperv</code> is the one that generates the error. If supervision is done on two different signals in the same phase, and both of them fails, the first one that is setup with is the one that generates the error.

Continues on next page

Sensor related errors

The following recoverable errors are generated and can be handled in an error handler. The system variable `ERRNO` will be set to:

<code>CAP_TRACK_ERR</code>	Track error occurs when reading data from sensor and after a time no valid data are received. One reason for this could be that the sensor cannot indicate the seam.
<code>CAP_TRACKSTA_ERR</code>	Track start error occurs when no valid data has been read from the laser track sensor.
<code>CAP_TRACKCOR_ERR</code>	Track correction error occurs when something goes wrong in the calculation of the offset.
<code>CAP_TRACKCOM_ERR</code>	The communication between the robot controller and the sensor equipment is broken.
<code>CAP_TRACKPFR_ERR</code>	It is not possible to continue tracking, if a power failure occurred during tracking.
<code>CAP_SEN_NO_MEAS</code>	The controller did not get a valid measurement from sensor.
<code>CAP_SEN_NOREADY</code>	The sensor is not ready yet.
<code>CAP_SEN_GENERRO</code>	A general sensor error occurred.
<code>CAP_SEN_BUSY</code>	The sensor is busy and cannot answer the request.
<code>CAP_SEN_UNKNOWN</code>	The command sent to the sensor is unknown to sensor.
<code>CAP_SEN_ILLEGAL</code>	The variable or block number sent to the sensor is illegal.
<code>CAP_SEN_EXALARM</code>	An external alarm occurred in the sensor.
<code>CAP_SEN_CAALARM</code>	A camera alarm occurred in the sensor.
<code>CAP_SEN_TEMP</code>	The sensor temperature is out of range.
<code>CAP_SEN_VALUE</code>	The value sent to the sensor is out of range.
<code>CAP_SEN_CAMCHECK</code>	The camera check failed.
<code>CAP_SEN_TIMEOUT</code>	The sensor did not respond within the time out time.

Errors possible in MultiMove systems

The following recoverable errors are generated and can be handled in an error handler. The system variable `ERRNO` will be set to:

<code>ERR_PATH_STOP</code>	When using synchronized motion this error is reported when an application controlling one mechanical unit detects a recoverable error and notifies other applications that something went wrong. If this error code is received from a <code>CapC</code> instruction, the error is a reaction on another error. All tasks using movement instructions in synchronized mode in a MultiMove system should have this <code>ERRNO</code> value defined in the error handler.
----------------------------	--

Continues on next page

1 Instructions

1.32 CapC - Circular CAP movement instruction

Continuous Application Platform (CAP)

Continued

Errors inherited from TriggX

The instruction `CapC` is based on the instruction `TriggC`. As a consequence you can get and handle the errors `ERR_AO_LIM` and `ERR_DIPLAG_LIM`, as in `TriggC`.

The system variable `ERRNO` will be set to:

<code>ERR_AO_LIM</code>	If the programmed <code>ScaleValue/SetValue</code> argument for the specified analog output signal <code>AOp/AOutput</code> in some of the connected <code>TriggSpeed/TriggRampAO</code> instructions, results are out of limit for the analog signal together with the programmed <code>Speed</code> in this instruction. The system variable <code>ERRNO</code> is set to <code>ERR_AO_LIM</code> .
<code>ERR_DIPLAG_LIM</code>	If the programmed <code>DipLag</code> argument in some of the connected <code>TriggSpeed</code> instructions, is too big in relation to the used system parameter <i>Event Preset Time</i> , the system variable <code>ERRNO</code> is set to <code>ERR_DIPLAG_LIM</code> .

Other CAP errors

The following recoverable errors are generated and can be handled in an error handler. The system variable `ERRNO` will be set to:

<code>CAP_ATPROC_START</code>	This recoverable error is generated at the end of the first <code>CapC/L</code> instruction of a sequence if the optional argument <code>\PreProcessTracking</code> is used. It can be handled in the error handler to start the process. For more information see <i>Operating manual - Tracking and searching with optical sensors</i> .
<code>CAP_NOPROC_END</code>	This error occurs when the instruction <code>CapNoProcess</code> is used to run a certain distance without application process and the end of this distance is reached. This is not really an error, but it uses the mechanisms of error recovery.
<code>CAP_MOV_WATCHDOG</code>	This error occurs when the switch <code>\Movestart_timer</code> is specified and the time between the process start (<code>MAIN_STARTED</code>) and the start of the robot movement exceeds the time specified with the switch.

CAP process

During continuous execution in both Auto mode and Manual mode, the CAP process is running, unless it is blocked. That means, that all data controlling the CAP process (that is, `Cdata`, `Weavestart`, `Weave` and `Movestart_timer`), are used. In these modes all CAP trigger activities are carried out, see [ICap - connect CAP events to trap routines on page 247](#).

In all other execution modes the CAP process is not running, and the `CapC` instruction behaves like a `MoveC` instruction.

Trigger conditions [T1] to [T8]

As the trigger conditions are fulfilled when the robot is positioned closer and closer to the end point, the defined trigger activities are carried out. The trigger conditions are fulfilled either at a certain distance before the end point of the instruction, or at a certain distance after the start point of the instruction, or at a certain point in time (limited to a short time) before the end point of the instruction.

Continues on next page

During stepping execution forwards, the I/O activities are carried out but the interrupt routines are not run. During stepping execution backwards, no trigger activities at all are carried out.

Limitations

There are some limitations in how the *CirPoint* and the *ToPoint* can be placed, as shown in the figure below.

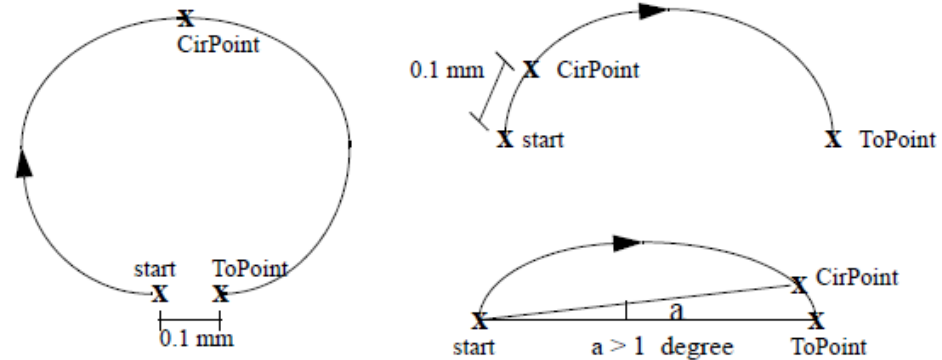

xx120000175

- Minimum distance between start and ToPoint is 0.1 mm.
- Minimum distance between start and CirPoint is 0.1 mm.
- Minimum angle between CirPoint and ToPoint from the start point is 1 degree.

The accuracy can be poor near the limits, for example, if the start point and the ToPoint on the circle are close to each other, the fault caused by the leaning of the circle can be much greater than the accuracy with which the points have been programmed.

A change of execution mode from forward to backward or vice versa, while the robot is stopped on a circular path, is not permitted and will result in an error message.

The instruction `CapC` (or any other instruction including circular movement) should never be started from the beginning, with TCP between the circle point and the end point. Otherwise the robot will not take the programmed path (positioning around the circular path in another direction compared with that programmed).

Make sure that the robot can reach the circle point during program execution and divide the circle segment if necessary.

If the current start point deviates from the usual, so that the total positioning length of the instruction `CapC` is shorter than usual, it may happen that several or all of the trigger conditions are fulfilled immediately and at the same position. In such cases, the sequence in which the trigger activities are carried out will be undefined. The program logic in the user program may not be based on a normal sequence of trigger activities for an "incomplete movement".

`CapC` cannot be executed in a RAPID routine connected to any of the following special system events: PowerOn, Stop, QStop, Restart, Reset or Step.

Continues on next page

1 Instructions

1.32 CapC - Circular CAP movement instruction

Continuous Application Platform (CAP)

Continued

Syntax

```
CapC
  [CirPoint ':='] < expression (IN) of robtarget >
  [ToPoint ':='] < expression (IN) of robtarget >
  ['\ ' Id ':=' < expression (IN) of identno > ] ', '
  [Speed ':='] < expression (IN) of speeddata >
  [Cdata ':='] < persistent (PERS) of capdata >
  ['\ ' Movestart_timer ':=' < expression (IN) of num > ] ', '
  [Weavestart ':='] < persistent (PERS) of weavestartdata >
  [Weave ':='] < persistent (PERS) of capweavedata >
  [Zone ':='] < expression (IN) of zonedata >
  ['\ ' Inpos ':=' < expression (IN) of stoppointdata >] ', '
  [Tool ':='] < persistent (PERS) of tooldata >
  ['\ ' WObj ':=' < persistent (PERS) of wobjdata > ]
  ['\ ' Track ':=' < persistent (PERS) of captrackdata > ]
  |[ '\ ' Corr]
  |[ '\ ' PreProcessTracking]
  ['\ ' Time ':=' < expression (IN) of num > ]
  ['\ ' T1 ':=' < variable (VAR) of triggdata > ]
  ['\ ' T2 ':=' < variable (VAR) of triggdata > ]
  ['\ ' T3 ':=' < variable (VAR) of triggdata > ]
  ['\ ' T4 ':=' < variable (VAR) of triggdata > ]
  ['\ ' T5 ':=' < variable (VAR) of triggdata > ]
  ['\ ' T6 ':=' < variable (VAR) of triggdata > ]
  ['\ ' T7 ':=' < variable (VAR) of triggdata > ]
  ['\ ' T8 ':=' < variable (VAR) of triggdata > ]
  ['\ ' TLoad ':=' < persistent (PERS) of loaddata > ] ';'

```

Related information

For information about	See
<i>Continuous Application Platform</i>	<i>Application manual - Continuous Application Platform</i>
Circular movement	MoveC - Moves the robot circularly on page 402
Circular movement with triggers	TriggC - Circular robot movement with events on page 891
Definition of CAP data	capdata - CAP data on page 1614
Definition of weave start data	weavestartdata - weave start data on page 1801
Definition of weave data	capweavedata - Weavedata for CAP on page 1628
Definition of track data	captrackdata - CAP track data on page 1625
<i>Path Offset</i>	<i>Application manual - Controller software IRC5</i>
Using optical sensors for tracking or searching.	<i>Operating manual - Tracking and searching with optical sensors</i>

1.33 CapCondSetDO - Set a digital output signal at TCP stop Continuous Application Platform (CAP)

1.33 CapCondSetDO - Set a digital output signal at TCP stop

Usage

CapSetDOAtStop is used to define a digital output signal and its value, which will be set when the TCP of the robot that runs CAP, stops moving during a CAP instruction (CapL or CapC) before the CAP sequence is finished.

An existing definition of such signals, is cleared with the CAP instruction InitSuperv.

Basic example

```
CapCondSetDO do15, 1;
```

The signal do15 is set to 1 when the TCP stops.

```
CapCondSetDO weld, off;
```

The signal weld is set to off when the TCP stops.

Arguments

```
CapCondSetDO Signal Value
```

Signal

Data type: `signaldo`

The name of the signal to be changed.

Value

Data type: `dionum`

The desired value of the signal 0 or 1.

Specified Value	Set digital output to
0	0
Any value except 0	1

Limitations

The final value of the signal depends on the configuration of the signal. If the signal is inverted in the system parameters, the value of the physical channel is the opposite.

A maximum of 10 signals per RAPID task may be set up.

Syntax

```
CapCondSetDO
  [Signal ':='] < variable (VAR) of signaldo > ','
  [Value ':='] < expression (IN) of dionum > ';'

```

Related information

For information about	See
Continuous Application Platform	Application manual - Continuous Application Platform
InitSuperv instruction	InitSuperv - Reset all supervision for CAP on page 282

Continues on next page

1 Instructions

1.33 CapCondSetDO - Set a digital output signal at TCP stop

Continuous Application Platform (CAP)

Continued

For information about	See
SetupSuperv instruction	SetupSuperv - Setup conditions for signal supervision in CAP on page 718
RemoveSuperv instruction	RemoveSuperv - Remove condition for one signal on page 605

1.34 CapEquiDist - Generate equidistant event

Usage

CapEquiDist is used to tell CAP to generate an equidistant RAPID event (EQUIDIST) on the CAP path. The first event is generated at the startpoint of the first CAP instruction in a sequence of CAP instructions. From RAPID it is possible to subscribe this event using ICap.

Basic example

```

VAR intnum intno_equi;

PROC main()
    .....
    IDelete intno_equi;
    Connect intno_equi equi_trp;
    ICap intno_equi, EQUIDIST
    .....
    CapEquiDist\Distance:=5.0;
    MoveL p60, v1000, fine, tWeldGun;
    CapL p_fig3_l_1, v500, cd, wsd, cwd, z10, tWeldGun;
    CapL p_fig3_l_2, v500, cd, wsd, cwd, fine, tWeldGun;
    .....
    CapEquiDist\Reset;
    MoveL p70, v1000, fine, tWeldGun;
    CapL p_fig3_l_3, v500, cd, wsd, cwd, fine, tWeldGun;
    .....

    ERROR
        Retry;
ENDPROC

TRAP equi_trp
    ! do whatever you want, but it must not take too long time
ENDTRAP

```

In this example, the event EQUIDIST will be generated on the first CAP path. It will be sent every 5 mm on the path over several CAP instructions with zones.

Arguments

```
CapEquiDist [\Distance] [\Reset]
```

[Distance]

Distance in mm

Data type: num

The data provided with this optional argument defines the distance in mm between two consecutive equidistant events.

[Reset]

Reset event generation

Continues on next page

1 Instructions

1.34 CapEquiDist - Generate equidistant event

Continuous Application Platform (CAP)

Continued

Data type: switch

If this switch is present, the event generation is reset, that is, the equidistant event will not be generated any longer on a CapL/CapC path. This switch has precedence before the \Distance switch.

Limitations

If the CAP path is long compared to the event distance, the system can run out of event resources, and the error message **50368 Too Short distance between equidistant events**.

Syntax

```
CapEquiDist  
  ['\ Distance :=' < expression (IN) of num >]  
  ['\ Reset] ';' 
```

Related information

For information about	See
<i>Continuous Application Platform</i>	<i>Application manual - Continuous Application Platform</i>

1.35 CapL - Linear CAP movement instruction

Usage

CapL is used to move the tool center point (TCP) linearly to a given destination and at the same time control a continuous process. Furthermore it is possible to connect up to eight events to CapL. The events are defined using the instructions TriggRampAO, TriggIO, TriggEquip, TriggInt, TriggCheckIO, or TriggSpeed.

Basic examples

Example1

Linear movements with CapL.

```
CapL p1, v100, cdata, weavestart, weave, z50, gun1;
```

The TCP of the tool, gun1, is moved linearly to the position p1, with speed defined in cdata, and zone data z50.

Example 2

Circular movement with user event and CAP event.

```
VAR intnum start_intno;
...
PROC main()
  VAR triggdata gunon;
  IDelete start_intno;
  CONNECT start_intno WITH start_trap;
  ICap start_intno, CAP_START;
  TriggIO gunon, 0 \Start \DOp:=gun, on;
  MoveJ p1, v500, z50, gun1;
  CapL p2, v500, cdata, wstart, w1, fine, gun1 \T1:=gunon;
ENDPROC

TRAP start_trap
  !This routine is executed when event CAP_START arrives
ENDTRAP
```

The digital output signal gun is set when the robot TCP passes the midpoint of the corner path of the point p1. The trap routine start_trap is executed when the CAP process is starting.

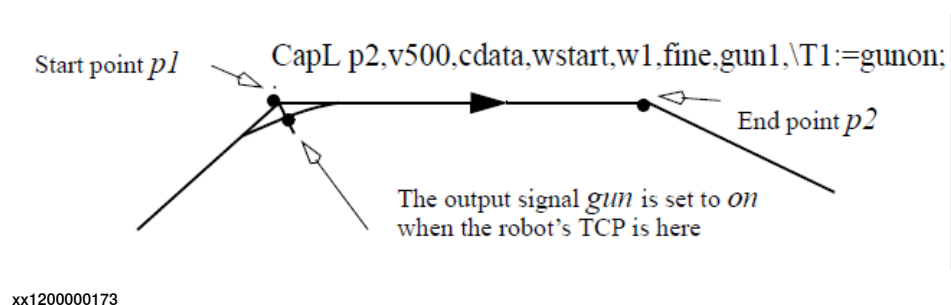

Continues on next page

1 Instructions

1.35 CapL - Linear CAP movement instruction

Continuous Application Platform (CAP)

Continued

Arguments

```
CapL ToPoint [\Id] Speed Cdata [\MoveStartTimer] Weavestart Weave  
Zone [\Inpos] Tool [\WObj] [\Track] | [\Corr]  
[\PreProcessTracking] [\Time] [\T1] [\T2] [\T3] [\T4] [\T5]  
[\T6] [\T7] [\T8] [\TLoad]
```

ToPoint

Data type: `robtarget`

The destination point of the robot and external axes. It is defined as a named position or stored directly in the instruction (marked with an * in the instruction).

[\ID]

Synchronization id

Data type: `identno`

The argument [\ID] is mandatory in MultiMove systems, if the movement is synchronized or coordinated synchronized. This argument is not allowed in any other case. The specified id number must be the same in all the cooperating program tasks. By using the id number the movements are not mixed up at the runtime.

Speed

Data type: `speeddata`

The speed data that applies to movements. Speed data defines the velocity of the TCP, the tool reorientation, and external axes.

Cdata

(CAP process Data)

Data type: `capdata`

CAP process data, see [capdata - CAP data on page 1614](#) for a detailed description.

[\Movestart_timer]

(Time in s)

Data type: `num`

Upper limit for the time difference between the order of the process start and the actual start of the robot's TCP movement in a MultiMove system in synchronized mode.

Weavestart

(Weavestart Data)

Data type: `weavestartdata`

Weave start data for the CAP process, see [weavestartdata - weave start data on page 1801](#) for a detailed description.

Weave

(Weave Data)

Data type: `capweavedata`

Weaving data for the CAP process, see [capweavedata - Weavedata for CAP on page 1628](#) for a detailed description.

Continues on next page

Zone

Data type: zonedata

Zone data for the movement. Zone data describes the size of the generated corner path.

[\Inpos]

In position

Data type: stoppoint data

This argument is used to specify the convergence criteria for the position of the robot's TCP in the stop point. The stop point data substitutes the zone specified in the Zone parameter.

Tool

Data type: tooldata

The tool in use when the robot moves. The tool center point is the point that is moved to the specified destination point.

[\Wobj]

Work Object

Data type: wobjdata

The work object (object coordinate system) to which the robot position in the instruction is related.

This argument can be omitted and if it is then the position is related to the world coordinate system. If, on the other hand, a stationary TCP or coordinated external axes are used this argument must be specified in order for a circle relative to the work object to be executed.

[\Track]

(Track Sensor Data)

Data type: captrackdata

This data structure contains data needed for use of path correction generating sensors together with CapL, see [captrackdata - CAP track data on page 1625](#). This argument is not allowed together with the argument \Corr.

[\Corr]

Correction

Data type: switch

Correction data written to a corrections entry by the instruction CorrWrite will be added to the path and destination position if this argument is present.

The RobotWare option *Path Offset* is required when using this argument.

[\PreProcessTracking]

Data type: switch

This argument is effective only if first_instruction is set to TRUE and the \Track argument is present.

Continues on next page

1 Instructions

1.35 CapL - Linear CAP movement instruction

Continuous Application Platform (CAP)

Continued

This argument activates *Pre Process Tracking*, which means that the robot will be tracking only, without process, during that CapX instruction. Thereby sensor data are available for successful tracking right off the start of the path with process, e.g. welding.

For more information see *Operating manual - Tracking and searching with optical sensors*.

[\Time]

Data type: num

This argument is used to specify the total time in seconds during which the robot and additional axes move. It is then substituted for the corresponding speed data.

[\T1]

Trigg 1

Data type: triggdata

Variable that refers to trigger conditions and trigger activity defined earlier in the program using the instructions `TriggIO`, `TriggEquip`, `TriggInt`, `TriggCheckIO`, `TriggSpeed`, or `TriggRampAO`.

[\T2]

Trigg 2

Data type: triggdata

Variable that refers to trigger conditions and trigger activity defined earlier in the program using the instructions `TriggIO`, `TriggEquip`, `TriggInt`, `TriggCheckIO`, `TriggSpeed`, or `TriggRampAO`.

[\T3]

Trigg 3

Data type: triggdata

Variable that refers to trigger conditions and trigger activity defined earlier in the program using the instructions `TriggIO`, `TriggEquip`, `TriggInt`, `TriggCheckIO`, `TriggSpeed`, or `TriggRampAO`.

[\T4]

Trigg 4

Data type: triggdata

Variable that refers to trigger conditions and trigger activity defined earlier in the program using the instructions `TriggIO`, `TriggEquip`, `TriggInt`, `TriggCheckIO`, `TriggSpeed`, or `TriggRampAO`.

[\T5]

Trigg 5

Data type: triggdata

Variable that refers to trigger conditions and trigger activity defined earlier in the program using the instructions `TriggIO`, `TriggEquip`, `TriggInt`, `TriggCheckIO`, `TriggSpeed`, or `TriggRampAO`.

Continues on next page

[\T6]

Trigg 6

Data type: triggdata

Variable that refers to trigger conditions and trigger activity defined earlier in the program using the instructions `TriggIO`, `TriggEquip`, `TriggInt`, `TriggCheckIO`, `TriggSpeed`, or `TriggRampAO`.

[\T8]

Trigg 8

Data type: triggdata

Variable that refers to trigger conditions and trigger activity defined earlier in the program using the instructions `TriggIO`, `TriggEquip`, `TriggInt`, `TriggCheckIO`, `TriggSpeed`, or `TriggRampAO`.

[\T8]

Trigg 8

Data type: triggdata

Variable that refers to trigger conditions and trigger activity defined earlier in the program using the instructions `TriggIO`, `TriggEquip`, `TriggInt`, `TriggCheckIO`, `TriggSpeed`, or `TriggRampAO`.

[\TLoad]

Total load

Data type: loaddata

The `\TLoad` argument describes the total load used in the movement. The total load is the tool load together with the payload that the tool is carrying. If the `\TLoad` argument is used, then the `loaddata` in the current `tooldata` is not considered. If the `\TLoad` argument is set to `load0`, then the `\TLoad` argument is not considered and the `loaddata` in the current `tooldata` is used instead.

To be able to use the `\TLoad` argument it is necessary to set the value of the system parameter `ModalPayLoadMode` to 0. If `ModalPayLoadMode` is set to 0, it is no longer possible to use the instruction `GripLoad`.

The total load can be identified with the service routine `LoadIdentify`. If the system parameter `ModalPayLoadMode` is set to 0, the operator has the possibility to copy the `loaddata` from the tool to an existing or new `loaddata` persistent variable when running the service routine.

It is possible to test run the program without any payload by using a digital input signal connected to the system input `SimMode` (Simulated Mode). If the digital input signal is set to 1, the `loaddata` in the optional argument `\TLoad` is not considered, and the `loaddata` in the current `tooldata` is used instead.



Note

The default functionality to handle payload is to use the instruction `GripLoad`. Therefore the default value of the system parameter `ModalPayLoadMode` is 1.

Continues on next page

1 Instructions

1.35 CapL - Linear CAP movement instruction

Continuous Application Platform (CAP)

Continued

Program execution

See [MoveL - Moves the robot linearly on page 458](#) for information about linear movement.

See [TriggL - Linear robot movements with events on page 935](#) for information about linear movement with trigg events.

Error handling

There are several different types of errors that can be handled in the error handler for the `CapC/CapL` instructions:

- supervision errors
- sensor specific errors
- errors specific to a MultiMove system
- errors inherited from `TriggX` functionality
- other CAP errors

If one of the signals that is supposed to be supervised does not have the correct value, or if it changes value during supervision, the system variable `ERRNO` is set.

If no values can be read from the track sensor, the system variable `ERRNO` is set.

For a MultiMove system running in synchronized mode the error handler must take care of two other errors. One is used to report that some other application has detected a recoverable error. This enables recoverable error handling in synchronized RAPID tasks. The other error, `CAP_MOV_WATCHDOG`, is reported if the time between the order of the process start and the actual start of the robot's TCP movement in a MultiMove system in synchronized mode expires. The time used is specified in the optional parameter `Movestart_timer` in the `CapL` instruction.

If anything abnormal is detected, program execution will stop. If, however, an error handler is programmed, the errors defined below can be remedied without stopping production. However, a recommendation is that some of the errors (the errors with `CAP_XX`) these errors should not be presented for the end user. Map those errors to a application specific error. For the supervision errors the instruction `CapGetFailSigs` can be used to get which specific signal that failed.

Supervision errors

The following recoverable errors are generated and can be handled in an error handler. The system variable `ERRNO` will be set to:

<code>CAP_PRE_ERR</code>	This error occurs when there is an error in the <code>PRE</code> supervision list, that is, when the conditions in the list are not met within the specified time frame (specified in <code>pre_cond time-out</code>).
<code>CAP_PRESTART_ERR</code>	This error occurs when there is an error during the supervision of the <code>PRESTART</code> phase.
<code>CAP_END_PRE_ERR</code>	This event occurs when there is an error in the <code>END_PRE</code> supervision list, that is, when the conditions in the list are not met within the specified time frame (specified in <code>start_cond time-out</code>).

Continues on next page

1.35 CapL - Linear CAP movement instruction Continuous Application Platform (CAP)

Continued

CAP_START_ERR	This event occurs when there is an error in the <code>START</code> supervision list, that is, when the conditions in the list are not met within the specified time frame (specified in <code>start_cond</code> time-out).
CAP_MAIN_ERR	This error occurs when there is an error during the supervision of the <code>MAIN</code> phase.
CAP_ENDMAIN_ERR	This error occurs when there is an error in the <code>END_MAIN</code> supervision list, that is, when the conditions in the list are not met within the specified time frame (specified in <code>end_main_cond</code> time-out).
CAP_START_POST1_ERR	This event occurs when there is an error in the <code>START_POST1</code> supervision list, that is, when the conditions in the list are not met within the specified time frame (specified in <code>end_main_cond</code> time-out).
CAP_POST1_ERR	This error occurs when there is an error during the supervision of the <code>POST1</code> phase.
CAP_POST1END_ERR	This error occurs when there is an error in the <code>END_POST1</code> supervision list, that is, when the conditions in the list are not met within the specified time frame (specified in <code>end_main_cond</code> time-out).
CAP_START_POST2_ERR	This event occurs when there is an error in the <code>START_POST2</code> supervision list, that is, when the conditions in the list are not met within the specified time frame (specified in <code>end_main_cond</code> time-out).
CAP_POST2_ERR	This error occurs when there is an error during the supervision of the <code>POST2</code> phase.
CAP_POST2END_ERR	This error occurs when there is an error in the <code>END_POST2</code> supervision list, that is, when the conditions in the list are not met within the specified time frame (specified in <code>end_main_cond</code> time-out). If supervision is done on two different signals in the same phase, and both of them fails, the first one that is setup with <code>SetupSuperv</code> is the one that generates the error.

Sensor related errors

The following recoverable errors are generated and can be handled in an error handler. The system variable `ERRNO` will be set to:

CAP_TRACK_ERR	Track error occurs when reading data from sensor and after a time no valid data are received. One reason for this could be that the sensor cannot indicate the seam.
CAP_TRACKSTA_ERR	Track start error occurs when no valid data has been read from the laser track sensor.
CAP_TRACKCOR_ERR	Track correction error occurs when something goes wrong in the calculation of the offset.
CAP_TRACKCOM_ERR	The communication between the robot controller and the sensor equipment is broken.
CAP_TRACKPFR_ERR	It is not possible to continue tracking, if a power failure occurred during tracking.
CAP_SEN_NO_MEAS	The controller did not get a valid measurement from sensor.
CAP_SEN_NOREADY	The sensor is not ready yet.
CAP_SEN_GENERRO	A general sensor error occurred.

Continues on next page

1 Instructions

1.35 CapL - Linear CAP movement instruction

Continuous Application Platform (CAP)

Continued

CAP_SEN_BUSY	The sensor is busy and cannot answer the request.
CAP_SEN_UNKNOWN	The command sent to the sensor is unknown to sensor.
CAP_SEN_ILLEGAL	The variable or block number sent to the sensor is illegal.
CAP_SEN_EXALARM	An external alarm occurred in the sensor.
CAP_SEN_CAALARM	A camera alarm occurred in the sensor.
CAP_SEN_TEMP	The sensor temperature is out of range.
CAP_SEN_VALUE	The value sent to the sensor is out of range.
CAP_SEN_CAMCHECK	The camera check failed.
CAP_SEN_TIMEOUT	The sensor did not respond within the time out time.

Errors possible in MultiMove systems

The following recoverable errors are generated and can be handled in an error handler. The system variable `ERRNO` will be set to:

ERR_PATH_STOP	When using synchronized motion this error is reported when an application controlling one mechanical unit detects a recoverable error and notifies other applications that something went wrong. If this error code is received from a <code>CapL</code> instruction, the error is a reaction on another error. All tasks using movement instructions in synchronized mode in a MultiMove system should have this <code>ERRNO</code> value defined in the error handler.
---------------	--

Errors inherited from `TriggX`

The instruction `CapL` is based on the instruction `TriggL`. As a consequence you can get and handle the errors `ERR_AO_LIM` and `ERR_DIPLAG_LIM`, as in `TriggL`.

The system variable `ERRNO` will be set to:

ERR_AO_LIM	If the programmed <code>ScaleValue/SetValue</code> argument for the specified analog output signal <code>AOp/AOutput</code> in some of the connected <code>TriggSpeed/TriggRampAO</code> instructions, results are out of limit for the analog signal together with the programmed <code>Speed</code> in this instruction. The system variable <code>ERRNO</code> is set to <code>ERR_AO_LIM</code> .
ERR_DIPLAG_LIM	If the programmed <code>DipLag</code> argument in some of the connected <code>TriggSpeed</code> instructions, is too big in relation to the used system parameter <i>Event Preset Time</i> , the system variable <code>ERRNO</code> is set to <code>ERR_DIPLAG_LIM</code> .

Other CAP errors

The following recoverable errors are generated and can be handled in an error handler. The system variable `ERRNO` will be set to:

CAP_ATPROC_START	This recoverable error is generated at the end of the first <code>CapC/L</code> instruction of a sequence if the optional argument <code>\PreProcessTracking</code> is used. It can be handled in the error handler to start the process. For more information see <i>Operating manual - Tracking and searching with optical sensors</i> .
CAP_NOPROC_END	This error occurs when the instruction <code>CapNoProcess</code> is used to run a certain distance without application process and the end of this distance is reached. This is not really an error, but it uses the mechanisms of error recovery.

Continues on next page

CAP_MOV_WATCHDOG	This error occurs when the switch <code>\Movestart_timer</code> is specified and the time between the process start (<code>MAIN_STARTED</code>) and the start of the robot movement exceeds the time specified with the switch.
------------------	---

CAP process

During continuous execution in both Auto mode and Manual mode, the CAP process is running, unless it is blocked. That means, that all data controlling the CAP process (that is, `Cdata`, `Weavestart`, `Weave` and `Movestart_timer`), are used. In these modes all CAP trigger activities are carried out, see [ICap - connect CAP events to trap routines on page 247](#).

In all other execution modes the CAP process is not running, and the `CapL` instruction behaves like a `MoveL` instruction.

Trigger conditions [T1] to [T8]

As the trigger conditions are fulfilled when the robot is positioned closer and closer to the end point, the defined trigger activities are carried out. The trigger conditions are fulfilled either at a certain distance before the end point of the instruction, or at a certain distance after the start point of the instruction, or at a certain point in time (limited to a short time) before the end point of the instruction.

During stepping execution forwards, the I/O activities are carried out but the interrupt routines are not run. During stepping execution backwards, no trigger activities at all are carried out.

Limitations

If the current start point deviates from the usual, so that the total positioning length of the instruction `CapL` is shorter than usual (for example, at the start of `CapL` with the robot position at the end point), it may happen that several or all of the trigger conditions are fulfilled immediately and at the same position. In such cases, the sequence in which the trigger activities are carried out will be undefined. The program logic in the user program may not be based on a normal sequence of trigger activities for an "incomplete movement".

The behavior of the CAP process may be undefined if an error occurs during `CapL` or `CapC` instructions with extremely short TCP movements (< 1 mm).

`CapL` cannot be executed in a RAPID routine connected to any of the following special system events: `PowerOn`, `Stop`, `QStop`, `Restart`, `Reset` or `Step`.

Syntax

```
CapL
  [ToPoint ':='] < expression (IN) of robtargt >
  ['\ Id ':='] < expression (IN) of identno > ', '
  [Speed ':='] < expression (IN) of speeddata > ', '
  [Cdata ':='] < persistent (PERS) of capdata >
  ['\ Movestart_timer ':='] < expression (IN) of num > ', '
  [Weavestart ':='] < persistent (PERS) of weavestartdata > ', '
  [Weave ':='] < persistent (PERS) of capweavedata > ', '
  [Zone ':='] < expression (IN) of zonedata >
  ['\ Inpos ':='] < expression (IN) of stoppointdata > ', '

```

Continues on next page

1 Instructions

1.35 CapL - Linear CAP movement instruction

Continuous Application Platform (CAP)

Continued

```
[Tool ':=' ] < persistent (PERS) of tooldata >
['\ ' WObj ':=' < persistent (PERS) of wobjdata >]
['\ ' Track ':=' < persistent (PERS) of captrackdata > ]
|[ '\ ' Corr]
|[ '\ ' PreProcessTracking]
['\ ' Time ':=' < expression (IN) of num > ]
['\ ' T1 ':=' < variable (VAR) of triggdata > ]
['\ ' T2 ':=' < variable (VAR) of triggdata > ]
['\ ' T3 ':=' < variable (VAR) of triggdata > ]
['\ ' T4 ':=' < variable (VAR) of triggdata > ]
['\ ' T5 ':=' < variable (VAR) of triggdata > ]
['\ ' T6 ':=' < variable (VAR) of triggdata > ]
['\ ' T7 ':=' < variable (VAR) of triggdata > ]
['\ ' T8 ':=' < variable (VAR) of triggdata > ]
['\ ' TLoad':=' < persistent (PERS) of loaddata > ] ';' 
```

Related information

For information about	See
<i>Continuous Application Platform</i>	<i>Application manual - Continuous Application Platform</i>
Linear movement	MoveL - Moves the robot linearly on page 458
Linear movement with triggers	TriggL - Linear robot movements with events on page 935
Definition of CAP data	capdata - CAP data on page 1614
Definition of weave start data	weavestartdata - weave start data on page 1801
Definition of weave data	capweavedata - Weavedata for CAP on page 1628
Definition of track data	captrackdata - CAP track data on page 1625
<i>Path Offset</i>	<i>Application manual - Controller software IRC5</i>
Using optical sensors for tracking or searching.	<i>Operating manual - Tracking and searching with optical sensors</i>

1.36 CapLATrSetup - Set up a Look-Ahead-Tracker

Usage

CapLATrSetup (*Set up a Look-Ahead-Tracker*) is used to set up a Look-Ahead-Tracker type of sensor, for example, Laser Tracker.

The sensor interface communicates with a maximum of two sensors over serial channels using the RTP1 transport protocol. The two channels must be named *laser1:* and *swg:*.

Basic example

SIO.cfg:

```
COM_TRP:
-Name "SCOUT:" -Type "RTP1"
-Name "digi-ip:" -Type "SOCKDEV" -PhyChannel "LAN1" -RemoteAddress
"192.168.125.5"
```

RAPID code:

```
! Define variable numbers
CONST num SensorOn := 6;
CONST num XCoord := 8;
CONST num YCoord := 9;
CONST num ZCoord := 10;
! Sensor calibration frame
PERS pose calibFrame := [[236.4,0.3,96.3],[1,0,0,0]];
! Trackdata
PERS captrackdata captrack1 := ["digi-ip:", [1,10,1,0,0,0,0,0]];

! Set up a Laser Tracker
CapLATrSetup "digi-ip:",
    calibFrame\SensorFreq:=20\CorrFilter:=5\MaxBlind:=100\MaxIncCorr:=2;

! Request start of sensor measurements
WriteVar "digi-ip:", SensorOn, 1;

! Track using Cap
CapL p_fig1_l_1, v200, cd_event1, wsd_event, cwd_event, z20,
    tWeldGun\Track:=captrack1;

! Stop sensor
WriteVar "digi-ip:", SensorOn, 0;
```

Arguments

```
CapLATrSetup device CalibFrame CalibPos [\WarnMaxCorr] [\LogFile]
[\LogSize] [\SensorFreq] [\IpolServoDelay] [\IpolCorrGain]
[\ServoSensFactor] [\CorrFilter] [\IpolCorrFilter]
[\ServoCorrFilter] [\ErrRampIn] [\ErrRampOut] [\CBAngle]
[\MaxBlind] [\MaxIncCorr] [\CalibFrame2] [\CalibFrame3]
```

device

Data type: string

Continues on next page

1 Instructions

1.36 CapLATrSetup - Set up a Look-Ahead-Tracker

Continuous Application Platform (CAP)

Continued

Device name as defined in sio.cfg.

calibframe

Data type: `pose`

LATR calibration frame (position and orientation relative the predefined tool tool0).

CalibPos

Data type: `pose`

LATR calibration offset. Adjustment of the sensor frame which places the origo of the path correction frame near the level of the tool frame used during calibration.

[WarnMaxCorr]

Data type: `switch`

If this switch is present, program execution is not interrupted, when the limit for maximum correction, specified in the trackdata, is exceeded. Only a warning will be sent.

[Logfile]

Data type: `string`

Name of tracklog log file.

[LogSize]

Data type: `num`

Size of the tracklog ring buffer, that is the number of sensor measurements that can be buffered during tracking.

Default: 1000.

[SensorFreq]

Data type: `num`

Defines the sample frequency of the sensor used (for example, M-Spot-90 has 5Hz sampling frequency).

The highest available value is dependent on the communication link and its speed. We recommend not to use values higher than 20Hz.

Default: 5 Hz.

[IpolServoDelay]

Data type: `num`

Defines an robot controller internal time delay between ipol task and servo task.

Default: 74 ms.



Note

Do not change the default value!

[IpolCorrGain]

Data type: `num`

Defines, the gain factor for the correction imposed on ipol.

Continues on next page

Default: 0.0.



Note

Do not change the default value!

[ServoSensFactor]

Data type: num

Defines the number of servo corrections per sensor reading.

Default: 0.



Note

Do not change the default value!

[CorrFilter]

Data type: num

Defines filtering of the correction calculated, using mean value over corr filter values.

Default: 1.



Note

Do not change the default value!

[IpolCorrFilter]

Data type: num

Defines filtering of the ipol correction, using mean value over path filter values.

Default: 1.



Note

Do not change the default value!

[ServoCorrFilter]

Data type: num

Defines filtering of the servo correction, using mean value over path servo filter values.

Default: 1.



Note

Do not change the default value!

[ErrRampIn]

Data type: num

Defines during how many sensor readings ramp in is done after error caused by sensor reading.

Continues on next page

1 Instructions

1.36 CapLATrSetup - Set up a Look-Ahead-Tracker

Continuous Application Platform (CAP)

Continued

Default: 1.

[\ErrorRampOut]

Data type: num

Defines during how many sensor readings ramp out is done when an error caused by sensor reading occurred.

Default: 1.

[\CBAngle]

Data type: num

Defines the angle between a 3D sensor beam and the sensor z-axis

Default: 0.0.

[\MaxBlind]

Data type: num

Maximum distance the TCP may move assuming, that the latest correction is still valid.

At the start of the tracking, the `MaxBlind` distance is automatically increased by the look ahead of the sensor.

Default: no limit.

[\MaxIncCorr]

Data type: num

Maximum incremental correction allowed.

If the incremental TCP correction is bigger than `\MaxIncCorr` and `\WarnMaxCorr` was specified, the robot will continue its path but the applied incremental correction will not exceed `\MaxIncCorr`. If `\WarnMaxCorr` was not specified, a track error is reported and program execution is stopped.

Default: 5 mm.

[\CalibFrame2]

Data type: pose

Alternative LATR calibration frame number 2 (position and orientation relative the predefined tool `tool0`).

[\CalibFrame3]

Data type: pose

Alternative LATR calibration frame number 3 (position and orientation relative the predefined tool `tool0`).

Syntax

```
CapLATrSetup
[device ':='] < expression (IN) of string > ','
[CalibFrame ':='] < persistent (PERS) of pose > ','
[CalibPos ':='] < persistent (PERS) of pos >
[\WarnMaxCorr]
[\LogFile ':=' < expression (IN) of string > ]
[\LogSize ':=' < expression (IN) of num > ]
```

Continues on next page

1.36 CapLATrSetup - Set up a Look-Ahead-Tracker Continuous Application Platform (CAP)

Continued

```
[\SensorFreq ':=' < expression (IN) of num >]
[\IpolServoDelay ':=' < expression (IN) of num >]
[\IpolCorrGain ':=' < expression (IN) of num >]
[\ServoSensFactor ':=' < expression (IN) of num >]
[\CorrFilter ':=' < expression (IN) of num >]
[\IpolCorrFilter ':=' < expression (IN) of num >]
[\ServoCorrFilter ':=' < expression (IN) of num >]
[\ErrRampIn ':=' < expression (IN) of num >]
[\ErrRampOut ':=' < expression (IN) of num >]
[\CBAngle ':=' < expression (IN) of num >]
[\MaxBlind ':=' < expression (IN) of num >]
[\MaxIncCorr ':=' < expression (IN) of num >]
[\CalibFrame2 ':=' < persistent (PERS) of pose >]
[\CalibFrame3 ':=' < persistent (PERS) of pose >] ';'

```

Related information

For information about	See
<i>Sensor Interface</i>	<i>Application manual - Controller software IRC5</i>
<i>Continuous Application Platform</i>	<i>Application manual - Continuous Application Platform</i>

1 Instructions

1.37 CapNoProcess - Run CAP without process *Continuous Application Platform (CAP)*

1.37 CapNoProcess - Run CAP without process

Usage

CapNoProcess is used to run CAP a certain distance without process.

With CapNoProcess, it is possible to tell CAP to execute a certain distance (in mm) without process. This is useful, if there was a recoverable process error, which in some way makes it impossible to restart the process at the error location.

In the beginning and at the end of the skip distance, backing on the path (restart_dist component in capdata) is suppressed.

At the end of the skip distance a error with errno CAP_NOPROC_END is generated.

Basic example

```
VAR num skip_dist := 0.0;
VAR bool cap_skip := FALSE;

PROC main()
    .....
    skip_dist := 25.0;
    CapL p_fig3_l_1, v500, cd, wsd, cwd, fine, tWeldGun;
    .....
    skip_dist := 15.0;
    CapL p_fig3_l_3, v500, cd, wsd, cwd, fine, tWeldGun;
    .....

    ERROR
    StorePath;
    TEST ERRNO
    CASE CAP_NOPROC_END:
        IF cap_skip THEN
            ! This is the end of the skip distance
            cap_skip := FALSE;
        ENDIF
    CASE CAP_MAIN_ERR:
        IF skip_dist > 0.0 THEN
            ! This is the start of the skip distance
            CapNoProcess skip_dist;
            cap_skip := TRUE;
        ENDIF
    DEFAULT:
    ENDTEST
    RestoPath;
    StartMoveRetry;
ENDPROC
ENDMODULE
```

In this example, the recoverable error CAP_MAIN_ERR is followed by 25 mm movement (at 10 mm/s) without process for the first CapL instruction and by 15

Continues on next page

1.37 CapNoProcess - Run CAP without process Continuous Application Platform (CAP) Continued

mm for the second. At the end of that distance, CAP_NOPROC_END is generated and the process is restarted.

Arguments

CapNoProcess skip_distance

skip_distance

Distance in mm

Data type: num

CapNoProcess has a num variable as input parameter, that defines the skip distance in mm.

Limitations

The speed of the TCP during skip is predefined with 10 mm/s. The shortest skip distance is predefined with 10 mm.

In synchronized MultiMove systems, the shortest distance of all skip distances defined for the different synchronized process robots will be the actual one.

If the skip distance is longer than the distance from the current TCP position to the end of the current sequence of CAP instructions, nothing special will happen: RAPID execution continues as usual, without stopping the robot.

Syntax

```
CapNoProcess
[skip_dist ':=' ] < variable (IN) of num > ;'
```

Related information

For information about	See
<i>Continuous Application Platform</i>	<i>Application manual - Continuous Application Platform</i>
InitSuperv	InitSuperv - Reset all supervision for CAP on page 282
SetupSuperv	SetupSuperv - Setup conditions for signal supervision in CAP on page 718
RemoveSuperv	RemoveSuperv - Remove condition for one signal on page 605

1 Instructions

1.38 CapRefresh - Refresh CAP data *Continuous Application Platform (CAP)*

1.38 CapRefresh - Refresh CAP data

Usage

CapRefresh is used to tell the CAP process to refresh its process data. It can for example, be used to tune CAP process parameters during program execution.

Basic example

```
PROC PulseSpeed()  
  ! Setup a 1 Hz timer interrupt  
  CONNECT intno1 WITH TuneTrp;  
  ITimer 1, intno1;  
  CapL p1, v100, cdata, wstartdata, wdata, fine, gun1;  
  IDelete intno1;  
ENDPROC  
  
TRAP TuneTrp  
  ! Modify the main speed component of active cdata  
  IF HighValueFlag = TRUE THEN  
    cdata.speed_data.start := 10;  
    HighValueFlag := FALSE;  
  ELSE  
    cdata.speed_data.start := 15;  
    HighValueFlag := TRUE;  
  ENDIF  
  ! Order the process control to refresh process parameters  
  CapRefresh;  
ENDTRAP
```

In this example the speed will be switched between 10 and 15 mm/s at a rate of 1 Hz.

Arguments

CapRefresh [*\MainSpeed*] [*\MainWeave*] [*\StartWeave*] [*\RestartDist*]

Without optional argument the CAP data capdata, capweavedata, weavestartdata, captrackdata, and movestarttimer are - if present - re-read from the PERSISTENT RAPID variable specified in the currently active CAP instruction.

[MainSpeed]

Data type: switch

If this switch is present, CAP will reread the component capdata.speed_data.main of the currently active CAP instruction.

[MainWeave]

Data type: switch

If this switch is present, CAP will reread the components capweavedata.width, capweavedata.length, capweavedata.bias, and capweavedata.active of the currently active CAP instruction.

Continues on next page

[StartWeave]

Data type: bool

If this switch is present, CAP will use its value instead of `weavestartdata.active` of the currently active CAP instruction. The data of the currently active CAP instruction remain untouched.

[RestartDist]

Data type: num

If this switch is present, CAP will use its value instead of `capdata.restart_dist` of the currently active CAP instruction. The data of the currently active CAP instruction remain untouched.

Syntax

```
CapRefresh
  ['\ ' MainSpeed]
  ['\ ' MainWeave]
  ['\ ' Startweave ':=' < expression (IN) of bool >]
  ['\ ' RestartDist ':=' < expression (IN) of num >] ';'

```

Related information

For information about	See
<i>Continuous Application Platform</i>	<i>Application manual - Continuous Application Platform</i>

1 Instructions

1.39 CAPSetStopMode - Set the stop mode for execution errors *Continuous Application Platform (CAP)*

1.39 CAPSetStopMode - Set the stop mode for execution errors

Usage

CAPSetStopMode sets the stop mode that should be used when the robot movement is stopped due to a process error. The default stop mode is SMOOTH_STOP_ON_PATH.

Basic example

```
CAPSetStopMode QUICK_STOP_ON_PATH;
```

Arguments

```
CAPSetStopMode StopMode;
```

StopMode

Data type: capstopmode

Stop mode, see [capstopmode - Defines stop modes for CAP on page 1624](#).

Syntax

```
CAPSetStopMode  
[StopMode ':='] <variable (VAR) of capstopmode> ';' 
```

Related information

For information about	See
Data type capstopmode	capstopmode - Defines stop modes for CAP on page 1624
<i>Continuous Application Platform</i>	<i>Application manual - Continuous Application Platform</i>

1.40 CapWeaveSync - set up signals and levels for weave synchronization Continuous Application Platform (CAP)

1.40 CapWeaveSync - set up signals and levels for weave synchronization

Usage

CapWeaveSync is used to setup weaving synchronization signals without sensors. The I/O signals must be defined in EIO.cfg.

Basic example

RAPID program:

```
PROC main()
...
CapWeaveSync \DoLeft:=do_sync_left \LevelLeft:=80
\DoRight:=do_sync_right \LevelRight:=80;
...
ENDPROC
```

In this example the signals `do_sync_left` and `do_sync_right` are set up with weaving level 80%.

The CapWeaveSync instruction should be executed only once, for example, from the startup shelf.

Arguments

```
CapWeaveSync [\Reset] [\DoLeft] [\LevelLeft] [\DoRight]
[\LevelRight]
```

[\Reset]

Data type: `switch`

Clear weave synchronization data.

[\DoLeft]

Data type: `signaldo`

Digital output signal for weave synchronization on the left weave cycle.

[\LevelLeft]

Data type: `num`

The coordination position on the left side of the weaving pattern. The value specified is a percentage of the width on the left of the weaving centre. When weaving is carried out beyond this point, a digital output signal is automatically set high (if the signal is defined).

This type of coordination can be used for seam tracking using Through-the-Arc Tracker.

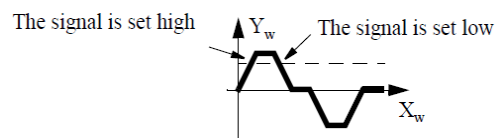

xx120000176

[\LevelRight]

Data type: `num`

Continues on next page

1 Instructions

1.40 CapWeaveSync - set up signals and levels for weave synchronization

Continuous Application Platform (CAP)

Continued

The coordination position on the left side of the weaving pattern. The value specified is a percentage of the width on the left of the weaving centre. When weaving is carried out beyond this point, a digital output signal is automatically set high (if the signal is defined).

This type of coordination can be used for seam tracking using Through-the-Arc Tracker.

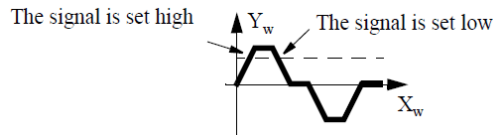

[DoRight]

Data type: signaldo

Digital output signal for weave synchronization on the right weave cycle.

[LevelRight]

Data type: num

The coordination position on the right side of the weaving pattern. The value specified is a percentage of the width on the right of the weaving centre. When weaving is carried out beyond this point, a digital output signal is automatically set high (provided the signal is defined).

This type of coordination can be used for seam tracking using Through-the-Arc Tracker.

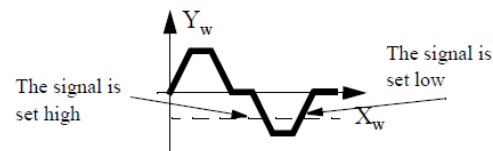

Program execution

The defined signals are checked and set when running without a sensor.

Limitations

The signals must be defined in EIO.cfg.

It is not possible to use only either level or corresponding signal. It will not result in errors when loading the RAPID file, but it will result in RAPID run-time errors for the instruction CapWeaveSynch.

Syntax

```
CapWeaveSync
  ['\ ' Reset]
  [DoLeft ':=' < expression (IN) of signaldo >]
  [LevelLeft ':=' < expression (IN) of num >]
  [DoRight ':=' < expression (IN) of signaldo >]
  [LevelRight ':=' < expression (IN) of num >] ';' ;'
```

Continues on next page

1.40 CapWeaveSync - set up signals and levels for weave synchronization Continuous Application Platform (CAP) Continued

Related information

For information about	See
<i>Continuous Application Platform</i>	<i>Application manual - Continuous Application Platform</i>
capweavedata data type	capweavedata - Weavedata for CAP on page 1628

1 Instructions

1.41 CheckProgRef - Check program references

RobotWare Base

1.41 CheckProgRef - Check program references

Usage

CheckProgRef is used to check for unresolved references at any time during execution.

Basic examples

The following example illustrates the instruction CheckProgRef:

Example 1

```
Load \Dynamic, diskhome \File:="PART_B.MOD" \CheckRef;  
Unload "PART_A.MOD";  
CheckProgRef;
```

In this case the program contains a module called PART_A.MOD. A new module PART_B.MOD is loaded, which checks if all references are OK. Then PART_A.MOD is unloaded. To check for unresolved references after unload, a call to CheckProgRef is done.

Program execution

Program execution forces a new link of the program task and checks for unresolved references.

If an error occurs during CheckProgRef, the program is not affected, it just tells you that an unresolved reference exists in the program task. Therefore, use CheckProgRef immediately after changing the number of modules in the program task (loading or unloading) to be able to know which module caused the link error.

This instruction can also be used as a substitute for using the optional argument \CheckRef in instruction Load or WaitLoad.

Error handling

The following recoverable errors can be generated. The errors can be handled in an ERROR handler. The system variable ERRNO will be set to:

Name	Cause of error
ERR_LINKREF	The program task contains unresolved references.

Syntax

```
CheckProgRef';'
```

Related information

For information about	See
Load of a program module	Load - Load a program module during execution on page 342
Unload of a program module	UnLoad - Unload a program module during execution on page 1010
Start loading of a program module	StartLoad - Load a program module during execution on page 787

Continues on next page

1.41 CheckProgRef - Check program references

RobotWare Base

Continued

For information about	See
Finish loading of a program module	WaitLoad - Connect the loaded module to the task on page 1061

1 Instructions

1.42 CirPathMode - Tool reorientation during circle path

RobotWare Base

1.42 CirPathMode - Tool reorientation during circle path

Usage

CirPathMode (*Circle Path Mode*) makes it possible to select different modes to reorientate the tool during circular movements.

This instruction can only be used in the main task T_ROB1 or, if in a MultiMove system in Motion tasks.

Description

PathFrame

The figure in the table shows the tool reorientation for the standard mode \PathFrame.

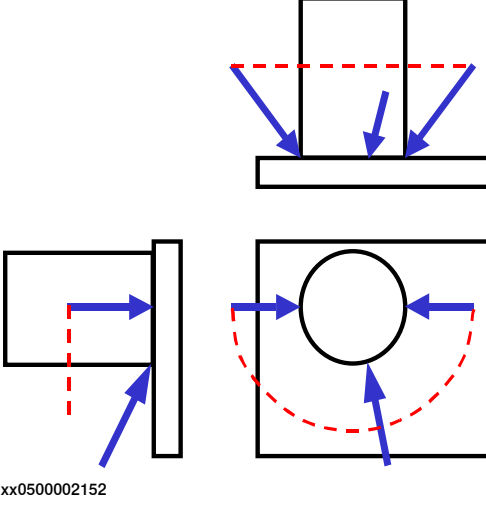
Illustration	Description
	<p>The arrows shows the tool from wrist center point to tool center point for the programmed points. The path for the wrist center point is dotted in the figure.</p> <p>The \PathFrame mode makes it easy to get the same angle of the tool around the cylinder. The robot wrist will not go through the programmed orientation in the CirPoint</p>

The figure in the table shows the use of standard mode \PathFrame with fixed tool orientation.

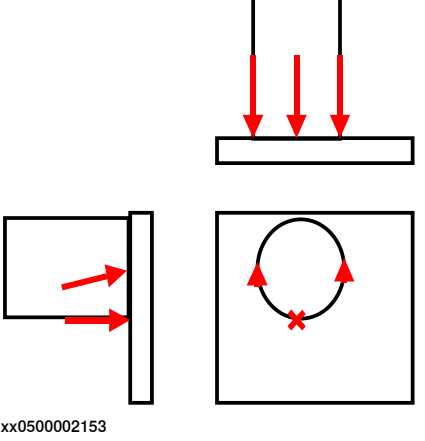
Illustration	Description
	<p>This picture shows the obtained orientation of the tool in the middle of the circle using a leaning tool and \PathFrame mode.</p> <p>Compare with the figure below when \ObjectFrame mode is used.</p>

Continues on next page

ObjectFrame

The figure in the table shows the use of modified mode `\ObjectFrame` with fixed tool orientation.

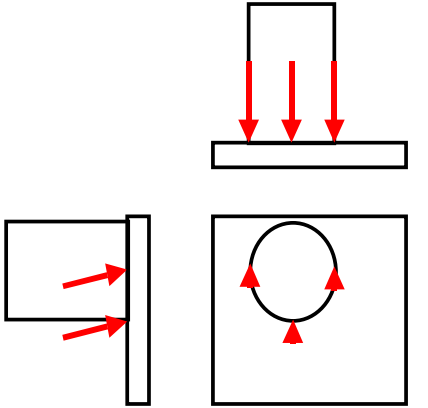
Illustration	Description
	<p>This figure shows the obtained orientation of the tool in the middle of the circle using a leaning tool and <code>\ObjectFrame</code> mode.</p> <p>This mode will make a linear reorientation of the tool in the same way as for <code>MoveL</code>. The robot wrist will not go through the programmed orientation in the <code>CirPoint</code>.</p> <p>Compare with the previous figure when <code>\PathFrame</code> mode is used.</p>

CirPointOri

The figure in the table shows the different tool reorientation between the standard mode `\PathFrame` and the modified mode `\CirPointOri`.

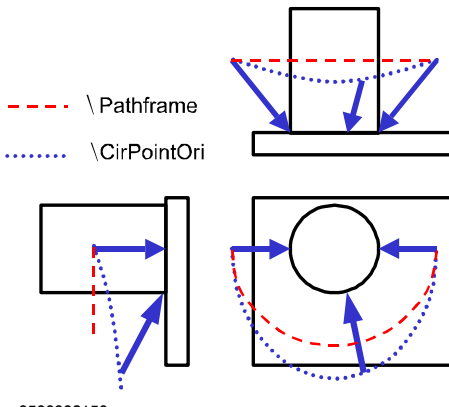
Illustration	Description
	<p>The arrows show the tool from wrist center point to tool center point for the programmed points. The different paths for the wrist center point are dashed in the figure.</p> <p>The <code>\CirPointOri</code> mode will make the robot wrist to go through the programmed orientation in the <code>CirPoint</code>.</p> <p>The path is always the same in xyz but the orientation is different.</p>

Continues on next page

1 Instructions

1.42 CirPathMode - Tool reorientation during circle path

RobotWare Base

Continued

Wrist45 / Wrist46 / Wrist56

The figure in the table shows the frames involved when cutting a shape using axes 4 and 5.

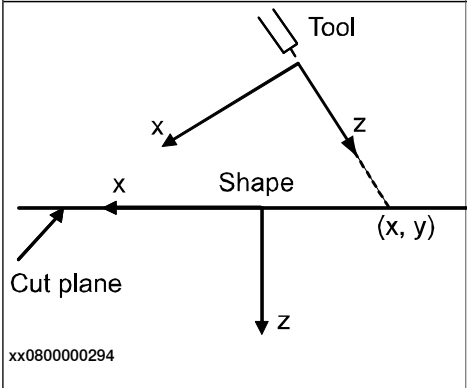
Illustration	Description
	It is assumed that the cutting beam is aligned with the tool's z axis. The coordinate frame of the cut plane is defined by the robot's starting position when executing the MoveC instruction.

Basic examples

The following examples illustrate the instruction `CirPathMode`:

Example 1

```
CirPathMode \PathFrame;
```

Standard mode for tool reorientation in the actual path frame from the start point to the `ToPoint` during all succeeding circular movements. This is default in the system.

Example 2

```
CirPathMode \ObjectFrame;
```

Modified mode for tool reorientation in actual object frame from the start point to the `ToPoint` during all succeeding circular movements.

Example 3

```
CirPathMode \CirPointOri;
```

Modified mode for tool reorientation from the start point via the programmed `CirPoint` orientation to the `ToPoint` during all succeeding circular movements.

Example 4

```
CirPathMode \Wrist45;
```

Modified mode such that the projection of the tool's z-axis onto the cut plane will follow the programmed circle movement order. Only wrist axes 4 and 5 are used. This mode should only be used when cutting thin objects.

Example 5

```
CirPathMode \Wrist46;
```

Modified mode such that the projection of the tool's z-axis onto the cut plane will follow the programmed circle movement order. Only wrist axes 4 and 6 are used. This mode should only be used for thin objects.

Example 6

```
CirPathMode \Wrist56;
```

Continues on next page

Modified mode such that the projection of the tool's z-axis onto the cut plane will follow the programmed circle movement order. Only wrist axes 5 and 6 are used. This mode should only be used for thin objects.

Arguments

```
CirPathMode [\PathFrame] | [\ObjectFrame] | [\CirPointOri] |
[\Wrist45] | [\Wrist46] | [\Wrist56]
```

[\PathFrame]

Data type: switch

During the circular movement the reorientation of the tool is done continuously from the start point orientation to the `ToPoint` orientation in the actual path frame. This is the standard mode in the system.



Note

Using `CirPathMode` without any switch gives the same result as `CirPathMode \PathFrame`.

[\ObjectFrame]

Data type: switch

During the circular movement the reorientation of the tool is done continuously from the start point orientation to the `ToPoint` orientation in the actual object frame.

[\CirPointOri]

Data type: switch

During the circular movement the reorientation of the tool is done continuously from the start point orientation to the programmed `CirPoint` orientation and further to the `ToPoint` orientation.

[\Wrist45]

Data type: switch

The robot will move axes 4 and 5 such that the projection of the tool's z-axis onto the cut plane will follow the programmed circle movement order. This mode should only be used for thin objects as only 2 wrist axes are used and thus give us increased accuracy but also less control.



Note

This switch requires the RobotWare option `WristMove`.

[\Wrist46]

Data type: switch

The robot will move axes 4 and 6 such that the projection of the tool's z-axis onto the cut plane will follow the programmed circle movement order. This mode should

Continues on next page

1 Instructions

1.42 CirPathMode - Tool reorientation during circle path

RobotWare Base

Continued

only be used for thin objects as only 2 wrist axes are used and thus give us increased accuracy but also less control.



Note

This switch requires the RobotWare option *WristMove*.

[`\Wrist56`]

Data type: `switch`

The robot will move axes 5 and 6 such that the projection of the tool's z-axis onto the cut plane will follow the programmed circle movement order. This mode should only be used for thin objects as only 2 wrist axes are used and thus give us increased accuracy but also less control.



Note

This switch requires the RobotWare option *WristMove*.

Program execution

The specified circular tool reorientation mode applies for the next executed circular movement instruction of any type (`MoveC`, `SearchC`, `TriggC`, `MoveCDO`, `MoveCSync`, `ArcC`, `PaintC`, etc.) and is valid until a new `CirPathMode` instruction is executed.

The standard circular reorientation mode (`CirPathMode \PathFrame`) is automatically set

- when using the restart mode **Reset RAPID**
- when loading a new program or a new module
- when starting program execution from the beginning
- when moving the program pointer to `main`
- when moving the program pointer to a routine
- when moving the program pointer in such a way that the execution order is lost.

Limitations

The instruction only affects circular movements.

When using the `\CirPointOri` mode, the `CirPoint` must be between the points **A** and **B** according to the figure below to make the circle movement to go through the programmed orientation in the `CirPoint`.

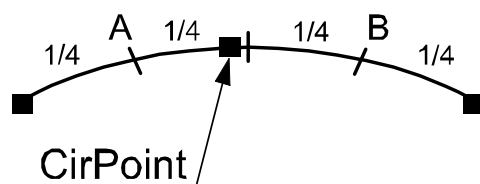

xx0500002149

Continues on next page

`\Wrist45`, `\Wrist46`, and `\Wrist56` mode should only be used for cutting thin objects as the ability to control the angle of the tool is lost when using only two wrist axes. Coordinated movements are not possible since the main axis is locked. If working in wrist singularity area and the instruction `SingArea\Wrist` has been executed, the instruction `CirPathMode` has no effect because the system then selects another tool reorientation mode for circular movements (joint interpolation).

Syntax

```
CirPathMode
  ['\PathFrame]
  | ['\ObjectFrame]
  | ['\CirPointOri]
  | ['\Wrist45]
  | ['\Wrist46]
  | ['\Wrist56] ';'

```

Related information

For information about	See
Motion settings data	motsetdata - Motion settings data on page 1692
Circular move instruction	MoveC - Moves the robot circularly on page 402
Define interpolation around singular points	SingArea - Defines interpolation around singular points on page 729
Interpolation	Technical reference manual - RAPID Overview
Wrist movements	Application manual - Controller software IRC5, section WristMove

1 Instructions

1.43 Clear - Clears the value

RobotWare Base

1.43 Clear - Clears the value

Usage

Clear is used to clear a numeric variable or persistent , that is, set it to 0.

Basic examples

The following examples illustrate the instruction Clear:

Example 1

```
Clear reg1;  
Reg1 is cleared, i.e. reg1:=0.
```

Example 2

```
VAR dnum mydnum:=5;  
Clear mydnum;  
mydnum is cleared, i.e. mydnum:=0.
```

Arguments

Clear Name | Dname

Name

Data type: num

The name of the variable or persistent to be cleared.

Dname

Data type: dnum

The name of the variable or persistent to be cleared.

Syntax

```
Clear  
[ Name ':=' ] < var or pers (INOUT) of num >  
| [ Dname ':=' ] < var or pers (INOUT) of dnum > ';' 
```

Related information

For information about	See
Incrementing a variable by 1	Incr - Increments by 1 on page 260
Decrementing a variable by 1	Decr - Decrements by 1 on page 186
Adding any value to a variable	Add - Adds a numeric value on page 32
Changing data using arbitrary	":=" - Assigns a value on page 41

1.44 ClearIOBuff - Clear input buffer of a serial channel

Usage

ClearIOBuff (*Clear I/O Buffer*) is used to clear the input buffer of a serial channel. All buffered characters from the input serial channel are discarded.

Basic examples

The following example illustrates the instruction ClearIOBuff:

Example 1

```
VAR iodev channel1;
...
Open "com1:", channel1 \Bin;
ClearIOBuff channel1;
WaitTime 0.1;
```

The input buffer for the serial channel referred to by `channel1` is cleared. The wait time guarantees the clear operation enough time to finish.

Arguments

ClearIOBuff IODevice

IODevice

Data type: iodev

The name (reference) of the serial channel whose input buffer is to be cleared.

Program execution

All buffered characters from the input serial channel are discarded. Next read instructions will wait for new input from the channel.

At power fail restart, any open file or serial channel in the system will be closed and the I/O descriptor in the variable of type `iodev` will be reset.

Limitations

This instruction can only be used for serial channels. Do not wait for acknowledgement of the operation to finish. Allow a wait time 0.1 after the instruction is recommended to give the operation enough time in every application.

Error handling

The following recoverable errors can be generated. The errors can be handled in an ERROR handler. The system variable `ERRNO` will be set to:

Name	Cause of error
ERR_FILEACC	The instruction is used on a file.

Syntax

```
ClearIOBuff
  [IODevice '[:=' ] <variable (VAR) of iodev>';'
```

Continues on next page

1 Instructions

1.44 ClearIOBuff - Clear input buffer of a serial channel

RobotWare Base

Continued

Related information

For information about	See
Opening a serial channel	<i>Technical reference manual - RAPID Overview</i>
File and serial channel handling	<i>Application manual - Controller software IRC5</i>

1.45 ClearPath - Clear current path

Usage

`ClearPath` (*Clear Path*) clears the whole motion path on the current motion path level (base level or `StorePath` level).

With motion path, meaning all the movement orders from any move instructions which have been executed in RAPID but not performed by the robot at the execution time of `ClearPath`.

The robot must be in a stop point position or must be stopped with `StopMove` before the instruction `ClearPath` can be executed.

Basic examples

The following example illustrates the instruction `ClearPath`:

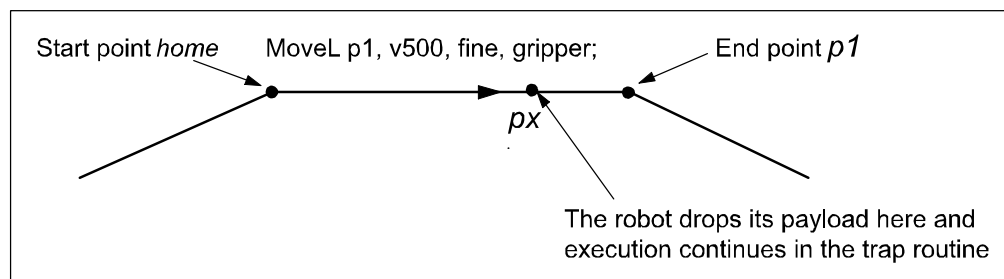

xx0500002154

In the following program example, the robot moves from the position `home` to the position `p1`. At the point `px` the signal `di1` will indicate that the payload has been dropped. The execution continues in the trap routine `gohome`. The robot will stop moving (start the braking) at `px`, the path will be cleared, the robot will move to position `home`. The error will be raised up to the calling routine `minicycle` and the whole user defined program cycle `procl ... proc2` will be executed from the beginning one more time.

Example 1

```

VAR intnum drop_payload;
VAR errnum ERR_DROP_LOAD := -1;

PROC minicycle()
  BookErrNo ERR_DROP_LOAD;
  procl;
  ...
  ERROR (ERR_DROP_LOAD)
    ! Restart the interrupted movement on motion base path level
    StartMove;
    RETRY;
ENDPROC

PROC procl()
  ...
  proc2;

```

Continues on next page

1 Instructions

1.45 ClearPath - Clear current path

RobotWare Base

Continued

```
...
ENDPROC

PROC proc2()
  CONNECT drop_payload WITH gohome;
  ISignalDI \Single, dil, 1, drop_payload;
  MoveL p1, v500, fine, gripper;
  .....
  IDelete drop_payload;
ENDPROC

TRAP gohome
  StopMove;
  ClearPath;
  IDelete drop_payload;
  StorePath;
  MoveL home, v500, fine, gripper;
  RestoPath;
  RAISE ERR_DROP_LOAD;
  ERROR
  RAISE;
ENDTRAP
```

If the same program is being run but **without** StopMove and ClearPath in the trap routine gohome, the robot will continue to position p1 before going back to position home.

Limitations

Limitation examples of the instruction ClearPath are illustrated below.

Example 1 - Limitation

```
VAR intnum int_move_stop;
...
PROC test_move_stop()
  CONNECT int_move_stop WITH trap_move_stop;
  ISignalDI dil, 1, int_move_stop;
  MoveJ p10, v200, z20, gripper;
  MoveL p20, v200, z20, gripper;
ENDPROC

TRAP trap_move_stop
  StopMove;
  ClearPath;
  StorePath;
  MoveJ p10, v200, z20, gripper;
  RestoPath;
  StartMove;
ENDTRAP
```

This is an example of ClearPath limitation. During the robot movement to p10 and p20, the ongoing movement is stopped and the motion path is cleared, but no action is done to break off the active instruction MoveJ p10 or MoveL p20 in the

Continues on next page

PROC test_move_stop. So the ongoing movement will be interrupted and the robot will go to p10 in the routine TRAP trap_move_stop, but no further movement to p10 or p20 in the PROC test_move_stop will be done. The program execution will be hanging.

This problem can be solved with either error recovery with long jump as described in example 2 below or with asynchronously raised error with instruction ProcerrRecovery.

Example 2 - No limitations

```

VAR intnum int_move_stop;
VAR errnum err_move_stop := -1;
...
PROC test_move_stop()
  BookErrNo err_move_stop;
  CONNECT int_move_stop WITH trap_move_stop;
  ISignalDI di1, 1, int_move_stop;
  MoveJ p10, v200, z20, gripper;
  MoveL p20, v200, z20, gripper;
  ERROR (err_move_stop)
    StopMove;
    ClearPath;
    StorePath;
    MoveJ p10, v200, z20, gripper;
    RestoPath;
    ! Restart the interrupted movement on motion base path level
    StartMove;
    RETRY;
ENDPROC

TRAP trap_move_stop
  RAISE err_move_stop;
  ERROR
    RAISE;
ENDTRAP

```

This is an example of how to use error recovery with long jump together with ClearPath without any limitation. During the robot movement to p10 and p20, the ongoing movement is stopped. The motion path is cleared, and because of error recovery through execution level boundaries, break off is done of the active instruction MoveJ p10 or MoveL p20. So the ongoing movement will be interrupted and the robot will go to p10 in the error handler, and once more execute the interrupted instruction MoveJ p10 or MoveL p20 in the PROC test_move_stop.

Syntax

```
ClearPath ';' ;'
```

Related information

For information about	See
Stop robot movements	StopMove - Stops robot movement on page 820

Continues on next page

1 Instructions

1.45 ClearPath - Clear current path

RobotWare Base

Continued

For information about	See
Error recovery	<i>Technical reference manual - RAPID Overview</i> <i>Technical reference manual - RAPID kernel</i>
Asynchronously raised error	ProcerrRecovery - Generate and recover from process-move error on page 550

1.46 ClearRawBytes - Clear the contents of rawbytes data

Usage

ClearRawBytes is used to set all the contents of a rawbytes variable to 0.

Basic examples

The following example illustrates the instruction ClearRawBytes:

Example 1

```
VAR rawbytes raw_data;
VAR num integer := 8
VAR num float := 13.4;

PackRawBytes integer, raw_data, 1 \IntX := DINT;
PackRawBytes float, raw_data, (RawBytesLen(raw_data)+1) \Float4;

ClearRawBytes raw_data \FromIndex := 5;
```

In the first 4 bytes the value of integer is placed (from index 1) and in the next 4 bytes starting from index 5 the value of float.

The last instruction in the example clears the contents of raw_data, starting at index 5, that is, float will be cleared, but integer is kept in raw_data.

Current length of valid bytes in raw_data is set to 4.

Arguments

```
ClearRawBytes RawData [ \FromIndex ]
```

RawData

Data type: rawbytes

RawData is the data container which will be cleared.

[\FromIndex]

Data type: num

With \FromIndex it is specified where to start clearing the contents of RawData. Everything is cleared to the end.

If \FromIndex is not specified, all data starting at index 1 is cleared.

Program execution

Data from index 1 (default) or from \FromIndex in the specified variable is reset to 0.

The current length of valid bytes in the specified variable is set to 0 (default) or to (FromIndex - 1) if \FromIndex is programmed.

Syntax

```
ClearRawBytes
  [RawData ' := ' ] < variable (VAR) of rawbytes>
  ['\FromIndex ' := ' <expression (IN) of num>'];'
```

Continues on next page

1 Instructions

1.46 ClearRawBytes - Clear the contents of rawbytes data

RobotWare Base

Continued

Related information

For information about	See
rawbytes data	rawbytes - Raw data on page 1721
Get the length of rawbytes data	RawBytesLen - Get the length of rawbytes data on page 1422
Copy the contents of rawbytes data	CopyRawBytes - Copy the contents of rawbytes data on page 169
Pack DeviceNet header into rawbytes data	PackDNHeader - Pack DeviceNet Header into rawbytes data on page 505
Pack data into rawbytes data	PackRawBytes - Pack data into rawbytes data on page 508
Write rawbytes data	WriteRawBytes - Write rawbytes data on page 1108
Read rawbytes data	ReadRawBytes - Read rawbytes data on page 593
Unpack data from rawbytes data	UnpackRawBytes - Unpack data from rawbytes data on page 1013
File and I/O device handling	Application manual - Controller software IRC5

1.47 ClkReset - Resets a clock used for timing

Usage

`ClkReset` is used to reset a clock that functions as a stop-watch used for timing. This instruction can be used before using a clock to make sure that it is set to 0.

Basic examples

The following example illustrates the instruction `ClkReset`:

Example 1

```
ClkReset clock1;
```

The clock `clock1` is reset.

Arguments

```
ClkReset Clock
```

Clock

Data type: `clock`

The name of the clock to reset.

Program execution

When a clock is reset, it is set to 0.

If a clock is running it will be stopped and then reset.

Syntax

```
ClkReset  
[ Clock ':= ' ] < variable (VAR) of clock > ';' ;
```

Related Information

For information about	See
Other clock instructions	<i>Technical reference manual - RAPID Overview</i>

1 Instructions

1.48 ClkStart - Starts a clock used for timing

RobotWare Base

1.48 ClkStart - Starts a clock used for timing

Usage

`ClkStart` is used to start a clock that functions as a stop-watch used for timing.

Basic examples

The following example illustrates the instruction `ClkStart`:

Example 1

```
ClkStart clock1;
```

The clock `clock1` is started.

Arguments

```
ClkStart Clock
```

Clock

Data type: `clock`

The name of the clock to start.

Program execution

When a clock is started, it will run and continue counting seconds until it is stopped.

A clock continues to run when the program that started it is stopped. However, the event that you intended to time may no longer be valid. For example, if the program was measuring the waiting time for an input, the input may have been received while the program was stopped. In this case, the program will not be able to “see” the event that occurred while the program was stopped.

A clock continues to run when the robot is powered down as long as the battery back-up retains the program that contains the clock variable.

If a clock is running it can be read, stopped, or reset.

Error handling

The following recoverable errors can be generated. The errors can be handled in an ERROR handler. The system variable `ERRNO` will be set to:

Name	Cause of error
<code>ERR_OVERFLOW</code>	The clock runs for 4,294,967 seconds (49 days 17 hours 2 minutes 47 seconds), then it is overflowed.

More examples

More examples of the instruction `ClkStart` are illustrated below.

Example 1

```
VAR clock clock2;  
VAR num time;  
  
ClkReset clock2;  
ClkStart clock2;  
WaitUntil dil = 1;  
ClkStop clock2;
```

Continues on next page

1.48 ClkStart - Starts a clock used for timing *RobotWare Base* *Continued*

```
time:=ClkRead(clock2);
```

The waiting time for di1 to become 1 is measured.

Syntax

```
ClkStart  
[ Clock ':= ' ] < variable (VAR) of clock >';'
```

Related Information

For information about	See
Other clock instructions	<i>Technical reference manual - RAPID Overview</i>

1 Instructions

1.49 ClkStop - Stops a clock used for timing

RobotWare Base

1.49 ClkStop - Stops a clock used for timing

Usage

ClkStop is used to stop a clock that functions as a stop-watch used for timing.

Basic examples

The following example illustrates the instruction ClkStop:

```
ClkStop clock1;
```

The clock clock1 is stopped.

Arguments

```
ClkStop Clock
```

Clock

Data type: clock

The name of the clock to stop.

Program execution

When a clock is stopped, it will stop running.

If a clock is stopped, it can be read, started again, or reset.

Error handling

The following recoverable errors are generated and can be handled in an error handler. The system variable ERRNO will be set to:

Name	Cause of error
ERR_OVERFLOW	The clock runs for 4,294,967 seconds (49 days 17 hours 2 minutes 47 seconds) it becomes overflowed.

Syntax

```
ClkStop  
[ Clock ' := ' ] < variable (VAR) of clock > ;'
```

Related Information

For information about	See
Other clock instructions	<i>Technical reference manual - RAPID Overview</i>
More examples	ClkStart - Starts a clock used for timing on page 148

1.50 Close - Closes a file or I/O device

Usage

Close is used to close a file or I/O device.

Basic examples

The following example illustrates the instruction Close:

Example 1

```
Close channel2;
```

The I/O device referred to by channel2 is closed.

Arguments

Close IODevice

IODevice

Data type: iodev

The name (reference) of the file or I/O device to be closed.

Program execution

The specified file or I/O device is closed and must be re-opened before reading or writing. If it is already closed the instruction is ignored.

Syntax

```
Close  
  [IODevice ':=' ] <variable (VAR) of iodev>';'
```

Related information

For information about	See
Opening a file or I/O device	<i>Technical reference manual - RAPID Overview</i>
File and I/O device handling	<i>Application manual - Controller software IRC5</i>

1 Instructions

1.51 CloseDir - Close a directory

RobotWare Base

1.51 CloseDir - Close a directory

Usage

CloseDir is used to close a directory in balance with OpenDir.

Basic examples

The following example illustrates the instruction CloseDir:

Example 1

```
PROC lmdir(string dirname)
  VAR dir directory;
  VAR string filename;
  OpenDir directory, dirname;
  WHILE ReadDir(directory, filename) DO
    TPWrite filename;
  ENDWHILE
  CloseDir directory;
ENDPROC
```

This example prints out the names of all files or subdirectories under the specified directory.

Arguments

CloseDir Dev

Dev

Data type: dir

A variable with reference to the directory fetched with instruction OpenDir.

Syntax

```
CloseDir
  [ Dev ' := ' ] < variable (VAR) of dir>';'
```

Related information

For information about	See
Directory	dir - File directory structure on page 1648
Make a directory	MakeDir - Create a new directory on page 353
Open a directory	OpenDir - Open a directory on page 503
Read a directory	ReadDir - Read next entry in a directory on page 1426
Remove a directory	RemoveDir - Delete a directory on page 602
Remove a file	RemoveFile - Delete a file on page 604
Rename a file	RenameFile - Rename a file on page 607
File and I/O device handling	Application manual - Controller software IRC5

1.52 Comment - Comment

Usage

`Comment` is only used to make the program easier to understand. It has no effect on the execution of the program.

Basic examples

The following example illustrates the instruction `Comment`:

Example 1

```
! Goto the position above pallet
MoveL p100, v500, z20, tool1;
```

A comment is inserted into the program to make it easier to understand.

Arguments

```
! Comment
```

`Comment`

Text string
Any text.

Program execution

Nothing happens when you execute this instruction.

Limitations

Comments in a record

In a record definition, it is not allowed to have a comment in a separate line unless it is the last line.

```
RECORD my_rec
  ! DISALLOWED COMMENT
  num mynum; ! allowed comment (not separate line)
  string mystring;
  ! allowed comment on last line
ENDRECORD
```

Syntax

```
'!' {<character>} <newline>
```

Related information

For information about	See
Characters permitted in a comment	<i>Technical reference manual - RAPID Overview</i>
Comments within data and routine declarations	<i>Technical reference manual - RAPID Overview</i>

1 Instructions

1.53 Compact IF - If a condition is met, then... (one instruction)

RobotWare Base

1.53 Compact IF - If a condition is met, then... (one instruction)

Usage

Compact IF is used when a single instruction is only to be executed if a given condition is met.

If different instructions are to be executed, depending on whether the specified condition is met or not, the IF instruction is used.

Basic examples

The following examples illustrate the instruction Compact IF:

Example 1

```
IF reg1 > 5 GOTO next;
```

If reg1 is greater than 5, program execution continues at the next label.

Example 2

```
IF counter > 10 Set do1;
```

The do1 signal is set if counter > 10.

Arguments

```
IF Condition ...
```

Condition

Data type: bool

The condition that must be satisfied for the instruction to be executed.

Syntax

```
IF <conditional expression> ( <instruction> | <SMT> ) ';' ;
```

Related information

For information about	See
Conditions (logical expressions)	<i>Technical reference manual - RAPID Overview</i>
IF with several instructions	IF - If a condition is met, then ...; otherwise ... on page 258

1.54 ConfJ - Controls the configuration during joint movement

Usage

`ConfJ` (*Configuration Joint*) is used to specify whether or not the robot's configuration is to be controlled during joint movement. If it is not controlled, the robot can sometimes use a different configuration than that which was programmed. With `ConfJ \Off`, the robot cannot switch main axis configuration - it will search for a solution with the same main axis configuration as the current one, but it moves to the closest wrist configuration for axes 4 and 6.

This instruction can only be used in the main task `T_ROB1` or, if in a MultiMove system, in Motion tasks.



Note

For IRB5400 and IRB5500, the robot monitoring is always off independent of what is specified in `ConfJ`.

Basic examples

The following examples illustrate the instruction `ConfJ`:

Example 1

```
ConfJ \Off;
MoveJ *, v1000, fine, tool1;
```

The robot moves to the programmed position and orientation. If this position can be reached in several different ways, with different axis configurations, the closest possible position is chosen.

Example 2

```
ConfJ \On;
MoveJ *, v1000, fine, tool1;
```

The robot moves to the programmed position, orientation and axis configuration.

Arguments

```
ConfJ [\On] | [\Off]
```

`[\On]`

Data type: `switch`

The robot moves to the programmed position with configuration parameters equal or close to the the given configuration parameters in the `confdata`.

If a program displacement or path correction is active, the risk for large movements is increased since the programmed configuration data is based on the original position.

The IRB 5400 robot will move to the programmed axis configuration or to an axis configuration close to the programmed one.

`[\Off]`

Data type: `switch`

The robot moves to the programmed position using the closest axis configuration.

Continues on next page

1 Instructions

1.54 ConfJ - Controls the configuration during joint movement

RobotWare Base

Continued

Program execution

The configuration applies for the next executed movement instruction until a new `ConfJ` instruction is executed.

If the argument `\On` (or no argument) is chosen, the robot moves to the programmed position with configuration parameters equal or close to the the given configuration parameters.

If a program displacement or path correction is active, the risk for large movements is increased since the programmed configuration data is based on the original position.

If the argument `\Off` is chosen, the robot always moves to the closest axis configuration. This may be different to the programmed one if the configuration has been incorrectly specified manually, or if a program displacement has been carried out.

Control of the configuration (`ConfJ \On`) is active by default. This is automatically set

- when using the restart mode **Reset RAPID**
- when loading a new program or a new module
- when starting program execution from the beginning
- when moving the program pointer to `main`
- when moving the program pointer to a routine
- when moving the program pointer in such a way that the execution order is lost.

Syntax

```
ConfJ  
[ '\ On' ] | [ '\ Off' ] ;'
```

Related information

For information about	See
Handling different configurations	<i>Technical reference manual - RAPID Overview</i>
Robot configuration during linear movement	ConfL - Monitors the configuration during linear movement on page 157
Motion settings data	motsetdata - Motion settings data on page 1692
Robot configuration data	confdata - Robot configuration data on page 1637

1.55 ConfL - Monitors the configuration during linear movement

Usage

ConfL (*Configuration Linear*) is used to specify whether or not the robot's configuration is to be monitored during linear or circular movement. If it is not monitored, the configuration at execution time may differ from that at programmed time. It may also result in unexpected sweeping robot movements when the mode is changed to joint movement.

This instruction can only be used in the main task T_ROB1 or, if in a MultiMove system, in Motion tasks.



Note

For IRB5400 and IRB5500, the robot monitoring is always off independent of what is specified in ConfL.

Basic examples

The following examples illustrate the instruction ConfL:

Example 1

```
ConfL \On;
MoveL *, v1000, fine, tool1;
```

Program execution stops when the programmed configuration is not possible to reach from the current position.

Example 2

```
SingArea \Wrist;
ConfL \On;
MoveL *, v1000, fine, tool1;
```

The robot moves to the programmed position, orientation and wrist axis configuration. If this is not possible, program execution stops.

Example 3

```
ConfL \Off;
MoveL *, v1000, fine, tool1;
```

The robot moves to the programmed position and orientation but to the closest possible axis configuration, which can be different from the programmed.

Arguments

```
ConfL [\On][\Off]
```

[\On]

Data type: switch

The robot configuration is monitored.

[\Off]

Data type: switch

The robot configuration is not monitored.

Continues on next page

1 Instructions

1.55 ConfL - Monitors the configuration during linear movement

RobotWare Base

Continued

Program execution

The configuration applies for the next executed movement instruction until a new ConfL instruction is executed.

During linear or circular movement, the robot always moves to the programmed position and orientation that has the closest possible axis configuration. If the argument \On (or no argument) is used, then the program execution stops as soon as there is a risk that the configuration of the programmed position will not be attained from the current position. The way that this is decided varies between robot types, see [confdata - Robot configuration data on page 1637](#).

Before an ordered movement is started, a verification is made to see if it is possible to achieve the programmed configuration. If it is not possible, the program is stopped. When the movement is finished (in a zone or in a finepoint), it is also verified that the robot has reached the programmed configuration.

If SingArea \Wrist is used, the robot always moves to the programmed wrist axis configuration.

If the argument \Off is used, there is no monitoring.

After a stop caused by a configuration error it is possible to restart the RAPID program in manual mode. Note that in this case, due to the reported error, the robot will most likely not move to the correct configuration.

If ConfL \Off is used with a big movement, it can cause stops directly or later in the program with error 50050 Position outside reach or 50080 Position not compatible.

Monitoring of the configuration (ConfL \On) is active by default. This is automatically set

- when using the restart mode **Reset RAPID**
- when loading a new program or a new module
- when starting program execution from the beginning
- when moving the program pointer to `main`
- when moving the program pointer to a routine
- when moving the program pointer in such a way that the execution order is lost.



Tip

A simple rule of thumb to avoid problems, both for ConfL\On and \Off, is to insert intermediate points to make the movement of each axis less than 180 degrees between points.



Tip

In a program with ConfL \Off it is recommended to have start points with known configurations points with “ConfJ \On and MoveJ” or “ConfL \On and SingArea \Wrist and MoveL” before movements in different program parts.

Continues on next page

Syntax

```
ConfL
  [ '\ ' On] | [ '\ ' Off]';'
```

Related information

For information about	See
Handling different configurations	<i>Technical reference manual - RAPID Overview</i>
Robot configuration during joint movement	ConfJ - Controls the configuration during joint movement on page 155
Define interpolation around singular points	SingArea - Defines interpolation around singular points on page 729
Motion settings data	motsetdata - Motion settings data on page 1692
Robot configuration data	confdata - Robot configuration data on page 1637

1 Instructions

1.56 CONNECT - Connects an interrupt to a trap routine

RobotWare Base

1.56 CONNECT - Connects an interrupt to a trap routine

Usage

`CONNECT` is used to find the identity of an interrupt and connect it to a trap routine. The interrupt is defined by ordering an interrupt event and specifying its identity. Thus, when that event occurs, the trap routine is automatically executed.

Basic examples

The following example illustrates the instruction `CONNECT`:

Example 1

```
VAR intnum feeder_low;
PROC main()
    CONNECT feeder_low WITH feeder_empty;
    ISignalDI di1, 1 , feeder_low;
    ...
```

An interrupt identity `feeder_low` is created which is connected to the trap routine `feeder_empty`. There will be an interrupt when input `di1` is getting high. In other words, when this signal becomes high, the `feeder_empty` trap routine is executed.

Arguments

`CONNECT` Interrupt WITH Trap routine

Interrupt

Data type: `intnum`

The variable that is to be assigned the identity of the interrupt. This must not be declared within a routine (routine data).

Trap routine

Identifier

The name of the trap routine.

Program execution

The variable is assigned an interrupt identity which shall be used when ordering or disabling interrupts. This identity is also connected to the specified trap routine.



Note

All interrupts in a task are cancelled when program pointer is set to main for that task and must be reconnected. The interrupts will not be affected by a power fail or a **Restart**.

Error handling

The following recoverable errors can be generated. The errors can be handled in an **ERROR** handler. The system variable `ERRNO` will be set to:

Name	Cause of error
<code>ERR_ALRDYCNT</code>	The interrupt variable is already connected to a trap routine.

Continues on next page

Name	Cause of error
ERR_CNTNOTVAR	The interrupt variable is not a variable reference.
ERR_INOMAX	No more interrupt numbers are available.

Limitations

An interrupt (interrupt identity) cannot be connected to more than one trap routine. Different interrupts, however, can be connected to the same trap routine.

When an interrupt has been connected to a trap routine, it cannot be reconnected or transferred to another routine; it must first be deleted using the instruction `IDelete`.

Interrupts that come or have not been handled when program execution is stopped will be neglected. The interrupts are not considered when stopping the program. Interrupts that has been set as safe will not be neglected at program stop. They will be handled when the program is started again.

Syntax

```
CONNECT <connect target> WITH <trap>';'
<connect target> ::= <variable>
                    | <parameter>
                    | <VAR>
<trap> ::= <identifier>
```

Related information

For information about	See
Summary of interrupts	<i>Technical reference manual - RAPID Overview</i>
More information on interrupt management	<i>Technical reference manual - RAPID Overview</i>
Data type for interrupt	intnum - Interrupt identity on page 1675
Cancelling an interrupt	IDelete - Cancels an interrupt on page 252

1 Instructions

1.57 ContactL - Linear contact movement

YuMi

1.57 ContactL - Linear contact movement

Usage

`ContactL` (*Contact Linear*) is used for the YuMi robot to obtain contact with an object at a desired position while moving the tool center point (TCP) linearly. The collision detection level is raised to its maximum value, and during the movement the robot supervises the internal torque and compares it to a torque level given by the user. When the requested user torque level is reached, the robot performs a stiff stop and continues with the rest of the program.

This instruction can typically be used when the tool held by the robot has to press an object into place.

This instruction can only be used in the main task `T_ROB1`, or in Motion tasks when in a *MultiMove* system.

The maximum speed for a `ContactL` instruction is 1000 mm/s.



Note

During programming it is recommended to first test with a slow speed, <100 mm/s, and then gradually increase the speed to the desired value.

Description

To find out the value for the torque level `desiredTorque` it is necessary to test the application and to view an internal test signal, signal 7901, using TuneMaster.

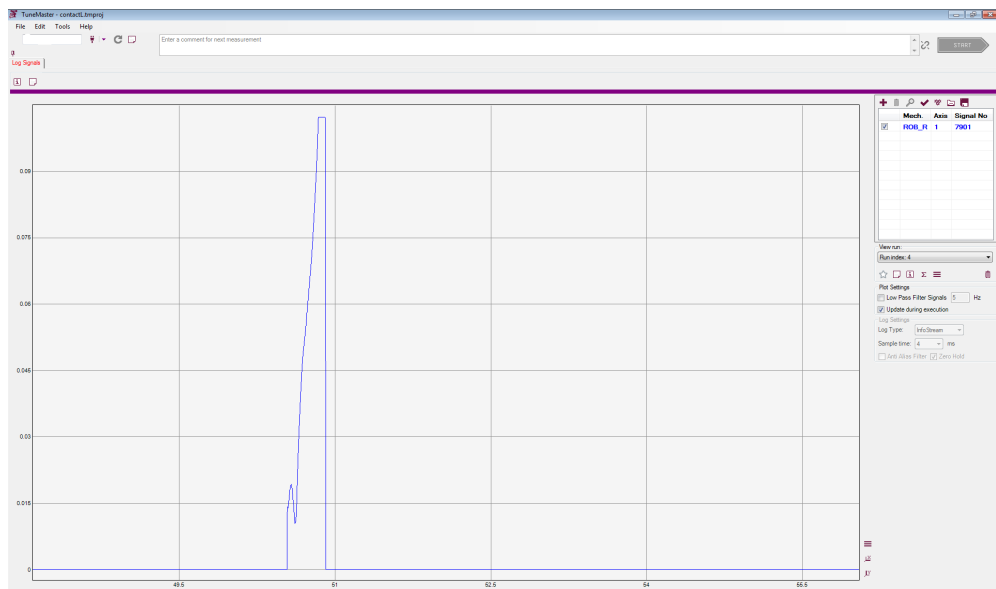

xx150000649

For more information about TuneMaster, see the help section included in the application.

Basic examples

The following examples illustrate the instruction `ContactL`:

Continues on next page

See also [More examples on page 165](#).

Example 1

```
desiredTorque := 0.1;
ContactL \DesiredTorque:=desiredTorque, p10, v100, tool1;
```

The TCP of `tool1` is moved linearly towards the position `p10` at a speed of `v100`. When the value of the internal torque level exceeds the `desiredTorque` level specified by the user, the robot will perform a stiff stop and then the program will continue from the position where the robot is stopped.

The argument `DesiredTorque` is optional. When `DesiredTorque` is omitted, the `ContactL` instruction will only raise the collision detection level to its maximum value, i.e. giving the opportunity to keep pressure on an object while moving the TCP.

If the `desiredTorque` is not reached when the robot reaches the desired position, there will be an execution error and the system stops with an event log. Therefore it is recommended to implement an error handler for such cases, see [Error handling on page 165](#).

Example 2

```
ContactL RelTool (CRobT(),5,5,0), v100, \Zone:=z10, tool1;
```

The robot is moved to a position that is 5 mm from its current position in the x direction and 5 mm from its current position in the y direction of the tool. If the `Zone` argument is omitted, the `ContactL` instruction will use a fine-point as default.

In the example the argument `DesiredTorque` is omitted. The instruction will only raise the collision detection level to its maximum value and the `ContactL` instruction will function similar to a `MoveL` instruction.

Example 3

```
desiredTorque := 0.9;
ContactL \DesiredTorque:=desiredTorque, p10, v100, tool1;
ContactL RelTool (CRobT(),5,5,0), v100, \Zone:=z10, tool1;
ContactL RelTool (CRobT(),5,5,-10), v100, \Zone:=z10, tool1;
MoveL ...
```

It is important to remember to use the `ContactL` instruction while in contact, but also when leaving contact. A normal move instruction will most probably trigger the motion supervision.

Arguments

```
ContactL [\DesiredTorque] ToPoint [\ID] Speed [\Zone] Tool [\WObj]
```

[\DesiredTorque]

Data type: num

User defined desired torque level.

`ContactL` will always use a fine-point as zone data for the destination if `DesiredTorque` is defined. When `DesiredTorque` is omitted the `ContactL` instruction will only raise the collision detection level and not supervise the internal torque level.

Continues on next page

1 Instructions

1.57 ContactL - Linear contact movement

YuMi

Continued

ToPoint

Data type: `robtarget`

The destination point of the robot and external axes. It is defined as a named position or stored directly in the instruction (marked with an * in the instruction).

[\ID]

Synchronization id

Data type: `identno`

The argument [\ID] is mandatory in the MultiMove systems, if the movement is synchronized or coordinated synchronized. This argument is not allowed in any other case. The specified id number must be the same in all the cooperating program tasks. By using the id number the movements are not mixed up at the runtime.

Speed

Data type: `speeddata`

The speed data that applies to movements. Speed data defines the velocity for the tool center point, the tool reorientation, and external axes.

[\Zone]

Data type: `zonedata`

Zone data for the movement. Zone data describes the size of the generated corner path and is only used when `DesiredTorque` is omitted.

If the [\Zone] argument is omitted the `ContactL` instruction will use a fine-point as default.

Tool

Data type: `tooldata`

The tool in use when the robot moves. The tool center point is the point that is moved to the specified destination position.

[\WObj]

Work Object

Data type: `wobjdata`

The work object (coordinate system) to which the robot position in the instruction is related.

This argument can be omitted and if so then the position is related to the world coordinate system. If, on the other hand, a stationary TCP or coordinated external axes are used then this argument must be specified for a linear movement relative to the work object to be performed.

Program execution

See the instruction `MoveL` for information about linear movement.

The robot movement stops when the internal torque level has exceeded the user defined torque level, assuming that the argument `DesiredTorque` is defined.

Otherwise the robot movement always continues to the programmed destination point.

Continues on next page

If the argument `DesiredTorque` is omitted the collision detection level is raised to its maximum value and no supervision of the internal torque level is performed, i.e. giving the opportunity to keep pressure on an object while moving the TCP.

Error handling

An error is reported during a `ContactL` when:

- `ContactL` reaches the point specified in the argument `ToPoint` without reaching the `DesiredTorque` specified by the user. This generates the error `ERR_CONTACTL`.

Errors can be handled in different ways depending on the selected running mode:

- **Continuous forward/Instruction forward:**
No position is returned and the movement always continues to the programmed destination point. The system variable `ERRNO` is set to `ERR_CONTACTL` and the error can be handled in the error handler of the routine.
- **Instruction backward:**
During backward execution the instruction carries out the movement without any torque supervision.

Example

```
VAR num desiredTorque;
...
desiredTorque := 0.1;
MoveL p10, v100, fine, tool1;
ContactL \DesiredTorque:=desiredTorque, p20, v100, tool1;
...
ERROR
  IF ERRNO=ERR_CONTACTL THEN
    StorePath;
    MoveL p10, v100, fine, tool1;
    RestoPath;
    ClearPath;
    StartMove;
    RETRY;
  ELSE
    Stop;
  ENDIF
ENDPROC
```

The robot moves from position `p10` to `p20`. If the robot reaches `p20` without reaching the `DesiredTorque` specified by the user, then the robot moves back to `p10` and tries once more.

More examples

More examples of the instruction `ContactL` are illustrated below.

Example 1

```
ContactL p10, v100, \Zone:=z10, tool1;
```

Continues on next page

1 Instructions

1.57 ContactL - Linear contact movement

YuMi

Continued

The TCP of `tool1` is moved linearly towards the position `p10` at a speed of `v100` and a zone size of 10 mm.

Since the argument `DesiredTorque` is omitted, the `ContactL` instruction will only raise the collision detection level to its maximum value and not supervise the internal torque level.

Limitations

The instruction `ContactL` can only be used for YuMi robots.

Syntax

```
ContactL
  ['\' DesiredTorque \',']
  [ToPoint ':=' ] <expression (IN) of robtarget>
  ['\' ID ':=' <expression (IN) of identno>'],'
  [Speed ':=' ] <expression (IN) of speeddata>
  ['\' Zone ':=' <expression (IN) of zonedata>'],'
  [Tool ':=' ] <persistent (PERS) of tooldata>
  ['\' WObj ':=' <persistent (PERS) of wobjdata>'];'
```

Related information

For information about	See
Using the IRB 14000	<i>Operating manual - IRB 14000</i>
Writes to a corrections entry	CorrWrite - Writes to a correction generator on page 180
Moves the robot linearly	MoveL - Moves the robot linearly on page 458
Definition of load	loaddata - Load data on page 1682
Defining the payload for a robot	GripLoad - Defines the payload for a robot on page 243
Using error handlers	<i>Technical reference manual - RAPID Overview</i>
Linear movement	
Motion in general	
LoadIdentify, load identification service routine	<i>Operating manual - IRC5 with FlexPendant</i>
System input signal <i>SimMode</i> for running the robot in simulated mode without payload.	<i>Technical reference manual - System parameters</i>
System parameter <i>ModalPayLoad-Mode</i> for activating and deactivating payload.	

1.58 CopyFile - Copy a file

Usage

`CopyFile` is used to make a copy of an existing file.

Basic examples

The following example illustrates the instruction `CopyFile`:

Example 1

```
CopyFile "HOME:/myfile", "HOME:/yourfile";
```

The file `myfile` is copied to `yourfile`. Both files are then identical.

```
CopyFile "HOME:/myfile", "HOME:/mydir/yourfile";
```

The file `myfile` is copied to `yourfile` in directory `mydir`.

Arguments

```
CopyFile OldPath NewPath
```

OldPath

Data type: string

The complete path of the file to be copied from.

NewPath

Data type: string

The complete path where the file is to be copied to.

Program execution

The file specified in `OldPath` will be copied to the file specified in `NewPath`.

Error handling

The following recoverable errors can be generated. The errors can be handled in an `ERROR` handler. The system variable `ERRNO` will be set to:

Name	Cause of error
<code>ERR_FILEACC</code>	The file specified in <code>OldPath</code> does not exist.
<code>ERR_FILEEXIST</code>	The file specified in <code>NewPath</code> already exists.

Syntax

```
CopyFile
[ OldPath ':' ] < expression (IN) of string > ','
[ NewPath ':' ] < expression (IN) of string > ';'
```

Related information

For information about	See
Make a directory	MakeDir - Create a new directory on page 353
Remove a directory	RemoveDir - Delete a directory on page 602
Rename a file	RenameFile - Rename a file on page 607

Continues on next page

1 Instructions

1.58 CopyFile - Copy a file

RobotWare Base

Continued

For information about	See
Remove a file	RemoveFile - Delete a file on page 604
Check file type	IsFile - Check the type of a file on page 1343
Check file size	FileSize - Retrieve the size of a file on page 1274
Check file system size	FSSize - Retrieve the size of a file system on page 1280
File and I/O device handling	Application manual - Controller software IRC5

1.59 CopyRawBytes - Copy the contents of rawbytes data

Usage

`CopyRawBytes` is used to copy all or part of the contents from one `rawbytes` variable to another.

Basic examples

The following example illustrates the instruction `CopyRawBytes`:

Example 1

```
VAR rawbytes from_raw_data;
VAR rawbytes to_raw_data;
VAR num integer := 8
VAR num float := 13.4;

ClearRawBytes from_raw_data;
PackRawBytes integer, from_raw_data, 1 \IntX := DINT;
PackRawBytes float, from_raw_data, (RawBytesLen(from_raw_data)+1)
\Float4;
CopyRawBytes from_raw_data, 1, to_raw_data, 3,
RawBytesLen(from_raw_data);
```

In this example the variable `from_raw_data` of type `rawbytes` is first cleared, that is all bytes set to 0. Then in the first 4 bytes the value of `integer` is placed and in the next 4 bytes the value of `float`.

After having filled `from_raw_data` with data, the contents (8 bytes) is copied to `to_raw_data`, starting at position 3.

Arguments

```
CopyRawBytes FromRawData FromIndex ToRawData ToIndex[\NoOfBytes]
```

`FromRawData`

Data type: `rawbytes`

`FromRawData` is the data container from which the `rawbytes` data shall be copied.

`FromIndex`

Data type: `num`

`FromIndex` is the position in `FromRawData` where the data to be copied starts. Indexing starts at 1.

`ToRawData`

Data type: `rawbytes`

`ToRawData` is the data container to which the `rawbytes` data shall be copied.

`ToIndex`

Data type: `num`

`ToIndex` is the position in `ToRawData` where the data to be copied will be placed. Everything is copied to the end. Indexing starts at 1.

Continues on next page

1 Instructions

1.59 CopyRawBytes - Copy the contents of rawbytes data

RobotWare Base

Continued

[\NoOfBytes]

Data type: num

The value specified with \NoOfBytes is the number of bytes to be copied from FromRawData to ToRawData.

If \NoOfBytes is not specified, all bytes from FromIndex to the end of current length of valid bytes in FromRawData is copied.

Program execution

During program execution data is copied from one rawbytes variable to another.

The current length of valid bytes in the ToRawData variable is set to:

- (ToIndex + copied_number_of_bytes - 1)
- The current length of valid bytes in the ToRawData variable is not changed, if the complete copy operation is done inside the old current length of valid bytes in the ToRawData variable.

Limitations

CopyRawBytes cannot be used to copy some data from one rawbytes variable to other part of the same rawbytes variable.

Syntax

```
CopyRawBytes
  [FromRawData ':='] < variable (VAR) of rawbytes> ', '
  [FromIndex ':='] < expression (IN) of num> ', '
  [ToRawData ':='] < variable (VAR) of rawbytes> ', '
  [ToIndex ':='] < expression (IN) of num>
  ['\NoOfBytes ':='] < expression (IN) of num> ]';'
```

Related information

For information about	See
rawbytes data	rawbytes - Raw data on page 1721
Get the length of rawbytes data	RawBytesLen - Get the length of rawbytes data on page 1422
Clear the contents of rawbytes data	ClearRawBytes - Clear the contents of rawbytes data on page 145
Pack DeviceNet header into rawbytes data	PackDNHeader - Pack DeviceNet Header into rawbytes data on page 505
Pack data into rawbytes data	PackRawBytes - Pack data into rawbytes data on page 508
Write rawbytes data	WriteRawBytes - Write rawbytes data on page 1108
Read rawbytes data	ReadRawBytes - Read rawbytes data on page 593
Unpack data from rawbytes data	UnpackRawBytes - Unpack data from rawbytes data on page 1013
File and I/O device handling	Application manual - Controller software IRC5

1.60 CornerPathWarning - Show or hide corner path warnings

Usage

`CornerPathWarning` is used to activate/deactivate corner path failure warnings (50024 event log) for all subsequent movement instructions.

This instruction can only be used in the main task `T_ROB1` or, if in a MultiMove system, in Motion tasks.

Basic examples

The following examples illustrate the instruction `CornerPathWarning`.

Example 1

```
CornerPathWarning TRUE;
```

Activating corner path warnings.

Example 2

```
PROC main()
  ! Deactivate corner path warning on all
  ! subsequent movement instructions
  CornerPathWarning FALSE;
  ...
  ! Check if warning is suppressed
  IF C_MOTSET.corner_path_warn_suppress=TRUE THEN
    CornerPathWarning TRUE;
  ENDIF
MyProcess;
```

Deactivate corner path warnings in start of program. Later on, check if the corner path warning is suppressed. If it is, activate corner path warning before calling `MyProcess`.

Arguments

`CornerPathWarning Active`

Active

Data type: `bool`

Specifies if the corner path warnings should be active.

Program execution

The setting applies for the next executed movement instruction, for both the robot and external axes, until a new `CornerPathWarning` instruction is executed.

A corner path failure occurs when the robot is executing a corner zone move instruction and the RAPID program execution does not provide a new move instruction in time. This forces the system to convert the programmed fly-by point to a fine point.

If set to true, any succeeding move instruction with a corner path failure will display a warning in the event log.

If set to false, corner path failures will still be executed as fine points but the warning will not be shown in the event log.

Continues on next page

1 Instructions

1.60 CornerPathWarning - Show or hide corner path warnings

RobotWare Base

Continued

To get the same behavior as in earlier versions of Robotware, where the warning could be removed in the configuration, the recommendation is to put `CornerPathWarning FALSE;` in the event routine executed at program start (event `START`).

The default value (report corner path error) is automatically set

- when using the restart mode **Reset RAPID**
- when loading a new program or a new module
- when starting program execution from the beginning
- when moving the program pointer to `main`
- when moving the program pointer to a routine
- when moving the program pointer in such a way that the execution order is lost.



Note

The recommendation is to have the corner path warning activated. Turn off the corner path warning only in situations where a warning sometimes occur. Such situations can be when waiting for some input (from I/O, cameras, sensors or other external equipment). A corner path warning can result in bad process performance and will lead to worse cycle times. All those situations needs to be analyzed before removing the corner path warning.

Syntax

```
CornerPathWarning  
  [Active ':='] <expression (IN) of bool>';'
```

Related information

For information about	See
Move instruction	MoveL - Moves the robot linearly on page 458
Corner path behavior	Section <i>Interpolation of corner paths</i> in <i>Technical reference manual - RAPID Overview</i>
Motion settings	motsetdata - Motion settings data on page 1692
Defining event routines	<i>Technical reference manual - System parameters</i>

1.61 CorrClear - Removes all correction generators

Descriptions

`CorrClear` is used to remove all connected correction generators. The instruction can be used to remove all offsets provided earlier by all correction generators.

Basic examples

The following example illustrates the instruction `CorrClear`:

Example 1

```
CorrClear;
```

The instruction removes all connected correction generators.



Note

An easy way to ensure that all correction generators (with corrections) are removed at program start, is to run `CorrClear` in a `START` event routine. See *Technical reference manual - System parameters*, the topic *Controller*.

Syntax

```
CorrClear ';' ;
```

Related information

For information about	See
Connects to a correction generator	CorrCon - Connects to a correction generator on page 174
Disconnects from a correction generator	CorrDiscon - Disconnects from a correction generator on page 179
Writes to a correction generator	CorrWrite - Writes to a correction generator on page 180
Reads the current total offsets	CorrRead - Reads the current total offsets on page 1224
Correction descriptor	corrdescr - Correction generator descriptor on page 1644

1 Instructions

1.62 CorrCon - Connects to a correction generator

Path Offset

1.62 CorrCon - Connects to a correction generator

Usage

`CorrCon` is used to connect to a correction generator.

Basic examples

The following example illustrates the instruction `CorrCon`:

See also [More examples on page 174](#).

Example1

```
VAR corrdescr id;  
...  
CorrCon id;
```

The correction generator reference corresponds to the variable `id` reservation.

Arguments

`CorrCon Descr`

Descr

Data type: `corrdescr`

Descriptor of the correction generator.

More examples

More examples of the instruction `CorrCon` are illustrated below.

Path coordinate system

All path corrections (offsets on the path) are added in the path coordinate system.

The path coordinate system is defined as illustrated below:

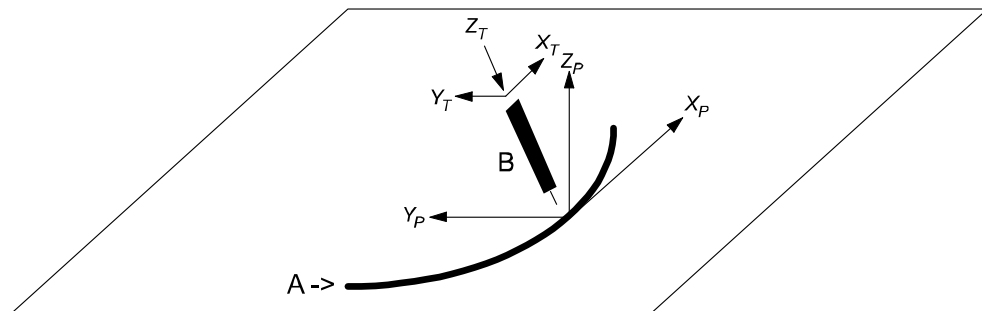

xx0500002156

A	Path direction
B	Tool
P	Path coordinate system
T	Tool coordinate system

- Path coordinate axis X is given as the tangent of the path.
- Path coordinate axis Y is derived as the cross product of path coordinate axis X and tool coordinate axis Z.

Continues on next page

- Path coordinate axis Z is derived as the cross product of path coordinate axis X and path coordinate axis Y.

Application example

An example of an application using path corrections is a robot holding a tool with two sensors mounted on it to detect the vertical and horizontal distances to a work object. The figure below illustrates a path correction device.

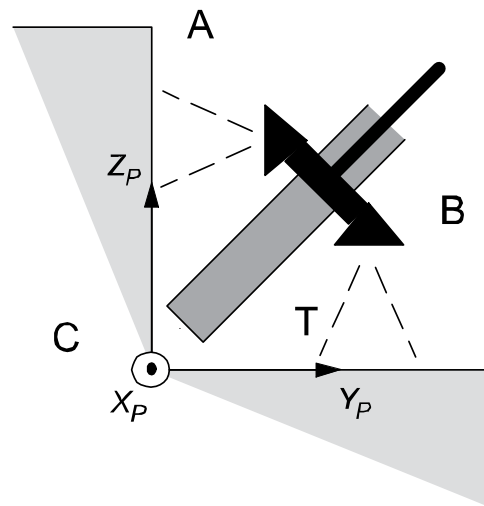

xx0500002155

A	Sensor for horizontal correction
B	Sensor for vertical correction
C	Path coordinate system
T	Tool

Program example



Note

hori_sig and **vert_sig** are analog signals defined in system parameters.

```

CONST num TARGET_DIST := 5;
CONST num SCALE_FACTOR := 0.5;
VAR intnum intnol;
VAR corrdescr hori_id;
VAR corrdescr vert_id;
VAR pos total_offset;
VAR pos write_offset;
VAR bool conFlag;
PROC PathRoutine()
    ! Connect to the correction generators for horizontal
    ! and vertical correction.
    CorrCon hori_id;
    CorrCon vert_id;
    conFlag := TRUE;

```

Continues on next page

1 Instructions

1.62 CorrCon - Connects to a correction generator

Path Offset

Continued

```
! Setup a 5 Hz timer interrupt. The trap routine will read the
! sensor values and compute the path corrections.
CONNECT intnol WITH ReadSensors;
ITimer\Single, 0.2, intnol;

! Position for start of contour tracking
MoveJ p10, v100, z10, tool1;
! Run MoveL with both vertical and horizontal correction.
MoveL p20, v100, z10, tool1 \Corr;

! Read the total corrections added by all connected
! correction generators.
total_offset := CorrRead();
! Write the total vertical correction on the FlexPendant.
TPWrite "The total vertical correction is:" \Num:=total_offset.z;

! Disconnect the correction generator for vertical correction.
! Horizontal corrections will be unaffected.
CorrDiscon vert_id;
conFlag := FALSE;

! Run MoveL with only horizontal interrupt correction.
MoveL p30, v100, fine, tool1 \Corr;
! Remove all outstanding connected correction generators.
! In this case, the only connected correction generator is
! the one for horizontal correction.
CorrClear;
! Remove the timer interrupt.
IDelete intnol;
ENDPROC
TRAP ReadSensors
VAR num horiSig;
VAR num vertSig;
! Compute the horizontal correction values and execute
! the correction.
horiSig := hori_sig;
write_offset.x := 0;
write_offset.y := (hori_sig - TARGET_DIST)*SCALE_FACTOR;
write_offset.z := 0;
CorrWrite hori_id, write_offset;

IF conFlag THEN
! Compute the vertical correction values and execute
! the correction.
write_offset.x := 0;
write_offset.y := 0;
write_offset.z := (vert_sig - TARGET_DIST)*SCALE_FACTOR;
CorrWrite vert_id, write_offset;
ENDIF
!Setup interrupt again
IDelete intnol;
```

Continues on next page

```
CONNECT intn01 WITH ReadSensors;
ITimer\single, 0.2, intn01;
ENDTRAP
```

Program explanation

Two correction generators are connected with the instruction `CorrCon`. Each correction generator is referenced by a unique descriptor (`hori_id` and `vert_id`) of the type `corrdescr`. The two sensors will use one correction generator each.

A timer interrupt is set up to call the trap routine `ReadSensors` with a frequency of 5 Hz. The offsets, needed for path correction, are computed in the trap routine and written to the corresponding correction generator (referenced by the descriptors `hori_id` and `vert_id`) by the instruction `CorrWrite`. All the corrections will have immediate effect on the path.

The `MoveL` instruction must be programmed with the switch argument `Corr` when path corrections are used. Otherwise, no corrections will be executed.

When the first `MoveL` instruction is ready, the function `CorrRead` is used to read the sum of all the corrections (the total path correction) given by all the connected correction generators. The result of the total vertical path correction is written to the FlexPendant with the instruction `TPWrite`.

`CorrDiscon` will then disconnect the correction generator for vertical correction (referenced by the descriptor `vert_id`). All corrections added by this correction generator will be removed from the total path correction. The corrections added by the correction generator for horizontal correction will still be preserved.

Finally, the function `CorrClear` will remove all remaining connected correction generators and their previously added corrections. In this case, it is only the correction generator for horizontal correction that will be removed. The timer interrupt will also be removed by the instruction `IDelete`.

The correction generators

The table below illustrates the correction generators.

X	Y	Z	Path coordinate axis
0	0	3	Vertical correction generator with the sum of all its own path corrections
0	1	0	Horizontal correction generator with the sum of all its own path corrections
-	-	-	Not connected correction generator
-	-	-	Not connected correction generator
-	-	-	Not connected correction generator
0	1	3	The sum of all corrections done by all connected correction generators

Limitations

- A maximum number of 5 correction generators can be connected simultaneously.
- Connected correction generators do not survive a controller restart.
- Sharp corners and backward execution should be avoided when using a correction generator, since correction is added in the path coordinate system.

Continues on next page

1 Instructions

1.62 CorrCon - Connects to a correction generator

Path Offset

Continued

Syntax

```
CorrCon  
    [ Descr ':= ' ] < variable (VAR) of corrdescr > ';' 
```

Related information

For information about	See
Disconnects from a correction generator	CorrDiscon - Disconnects from a correction generator on page 179
Writes to a correction generator	CorrWrite - Writes to a correction generator on page 180
Reads the current total offsets	CorrRead - Reads the current total offsets on page 1224
Removes all correction generators	CorrClear - Removes all correction generators on page 173
Correction generator descriptor	corrdescr - Correction generator descriptor on page 1644

1.63 CorrDiscon - Disconnects from a correction generator

Description

`CorrDiscon` is used to disconnect from a previously connected correction generator. The instruction can be used to remove corrections given earlier.

Basic examples

The following example illustrates the instruction `CorrDiscon`:

See also [More examples on page 179](#).

Example 1

```
VAR corrdescr id;
...
CorrCon id;
...
CorrDiscon id;
```

`CorrDiscon` disconnects from the previously connected correction generator referenced by the descriptor id.

Arguments

`CorrDiscon Descr`

Descr

Data type: `corrdescr`

Descriptor of the correction generator.

More examples

For more examples of the instruction `CorrDiscon`, see [CorrCon - Connects to a correction generator on page 174](#).

Syntax

```
CorrDiscon
  [ Descr ':= ' ] < variable (VAR) of corrdescr > ';' ;
```

Related information

For information about	See
Connects to a correction generator	CorrCon - Connects to a correction generator on page 174
Writes to a correction generator	CorrWrite - Writes to a correction generator on page 180
Reads the current total offsets	CorrRead - Reads the current total offsets on page 1224
Removes all correction generators	CorrClear - Removes all correction generators on page 173
Correction descriptor	corrdescr - Correction generator descriptor on page 1644

1 Instructions

1.64 CorrWrite - Writes to a correction generator

Path Offset

1.64 CorrWrite - Writes to a correction generator

Description

`CorrWrite` is used to write offsets in the path coordinate system to a correction generator.

Basic examples

The following example illustrates the instruction `CorrWrite`:

Example 1

```
VAR corrdescr id;  
VAR pos offset;  
...  
CorrWrite id, offset;
```

The current offsets, stored in the variable `offset`, are written to the correction generator referenced by the descriptor `id`.

Arguments

`CorrWrite Descr Data`

Descr

Data type: `corrdescr`
Descriptor of the correction generator.

Data

Data type: `pos`
The offset to be written.

More examples

For more examples of the instruction `CorrWrite`, see [CorrCon - Connects to a correction generator on page 174](#).

Limitations

The best performance is achieved on straight paths. As the speed and angles between consecutive linear paths increase, the deviation from the expected path will also increase. The same applies to circles with decreasing circle radius.

Syntax

```
CorrWrite  
[ Descr ':= ' ] < variable (VAR) of corrdescr > ','  
[ Data ':= ' ] < expression (IN) of pos > ';' 
```

Related information

For information about	See
Connects to a correction generator	CorrCon - Connects to a correction generator on page 174
Disconnects from a correction generator	CorrDiscon - Disconnects from a correction generator on page 179

Continues on next page

1.64 CorrWrite - Writes to a correction generator

Path Offset

Continued

For information about	See
Reads the current total offsets	CorrRead - Reads the current total offsets on page 1224
Removes all correction generators	CorrClear - Removes all correction generators on page 173
Correction generator descriptor	corrdescr - Correction generator descriptor on page 1644

1 Instructions

1.65 DeactEventBuffer - Deactivation of event buffer

RobotWare Base

1.65 DeactEventBuffer - Deactivation of event buffer

Description

`DeactEventBuffer` is used to deactivate the use of the event buffer in current motion program task.

The instructions `DeactEventBuffer` and `ActEventBuffer` should be used when combining an application using finepoints and a continuous application where signals needs to be set in advance due to slow process equipment.

This instruction can only be used in the main task `T_ROB1` or, if in a `MultiMove` system, in Motion tasks.

Basic examples

The following example illustrates the instruction `DeactEventBuffer`:

Example 1

```
..
DeactEventBuffer;
! Use an application that use finepoints, such as SpotWelding
..
! Activate the event buffer again
ActEventBuffer;
! Now it is possible to use an application that needs
! to set signals in advance, such as Dispense
..
```

The `DeactEventBuffer` deactivates the configured event buffer. When using an application with finepoints, the start of the robot from the finepoint will be faster. When activating the the event buffer with `ActEventBuffer`, it is possible to set signals in advance for an application with slow process equipment.

Program execution

The deactivation of an event buffer applies for the next executed robot movement instruction of any type and is valid until a `ActEventBuffer` instruction is executed.

The instruction will wait until the robot and external axes has reached the stop point (`ToPoint` of current move instruction) before the deactivation of the event buffer. Therefore it is recommended to program the movement instruction preceding `DeactEventBuffer` with a fine point.

The default value (`ActEventBuffer`) is automatically set

- when using the restart mode **Reset RAPID**
- when loading a new program or a new module
- when starting program execution from the beginning
- when moving the program pointer to `main`
- when moving the program pointer to a routine
- when moving the program pointer in such a way that the execution order is lost.

Continues on next page

Limitations

`DeactEventBuffer` cannot be executed in a RAPID routine connected to any of the following special system events: PowerOn, Stop, QStop, Restart or Step.

Syntax

```
DeactEventBuffer ';' ;
```

Related information

For information about	See
Activation of event buffer	ActEventBuffer - Activation of event buffer on page 28
Configuration of Event preset time	<i>Technical reference manual - System parameters</i>
Motion settings data	motsetdata - Motion settings data on page 1692

1 Instructions

1.66 DeactUnit - Deactivates a mechanical unit

RobotWare Base

1.66 DeactUnit - Deactivates a mechanical unit

Usage

DeactUnit is used to deactivate a mechanical unit.

It can be used to determine which unit is to be active when, for example, common drive units are used.

This instruction can only be used in the main task T_ROB1 or, if in a MultiMove system, in Motion tasks.

Examples

The following examples illustrate the instruction DeactUnit:

Example 1

```
DeactUnit orbit_a;
```

Deactivation of the orbit_a mechanical unit.

Example 2

```
MoveL p10, v100, fine, tool1;  
DeactUnit track_motion;  
MoveL p20, v100, z10, tool1;  
MoveL p30, v100, fine, tool1;  
ActUnit track_motion;  
MoveL p40, v100, z10, tool1;
```

The unit track_motion will be stationary when the robot moves to p20 and p30. After this, both the robot and track_motion will move to p40.

Example 3

```
MoveL p10, v100, fine, tool1;  
DeactUnit orbit1;  
ActUnit orbit2;  
MoveL p20, v100, z10, tool1;
```

The unit orbit1 is deactivated and orbit2 is activated.

Arguments

```
DeactUnit MechUnit
```

MechUnit

Mechanical Unit

Data type: mecunit

The name of the mechanical unit that is to be deactivated.

Program execution

When the robot's and external axes' actual path is ready, the path on current path level is cleared and the specified mechanical unit is deactivated. This means that it will neither be controlled nor monitored until it is re-activated.

If several mechanical units share a common drive unit, deactivation of one of the mechanical units will also disconnect that unit from the common drive unit.

Continues on next page

Limitations

Instruction `DeactUnit` cannot be used when one of the mechanical unit is in independent mode.

If this instruction is preceded by a move instruction, that move instruction must be programmed with a stop point (zonedata `fine`), not a fly-by point, otherwise restart after power failure will not be possible.

`DeactUnit` cannot be executed in a RAPID routine connected to any of following special system events: `PowerOn`, `Stop`, `QStop`, `Restart` or `Step`.

It is possible to use `ActUnit` - `DeactUnit` on `StorePath` level, but the same mechanical units must be active when doing `RestoPath` as when `StorePath` was done. If such operation the Path Recorder and the path on the base level will be intact, but the path on the `StorePath` level will be cleared.

Syntax

```
DeactUnit
  [MechUnit ':='] < variable (VAR) of mecunit> ';'

```

Related information

For information about	See
Activating mechanical units	ActUnit - Activates a mechanical unit on page 30
Mechanical units	mecunit - Mechanical unit on page 1690
Check if a mechanical unit is activated or not.	IsMechUnitActive - Is mechanical unit active on page 1349
Path Recorder	PathRecMoveBwd - Move path recorder backwards on page 522 mecunit - Mechanical unit on page 1690

1 Instructions

1.67 Decr - Decrements by 1 *RobotWare Base*

1.67 Decr - Decrements by 1

Usage

`Decr` is used to subtract 1 from a numeric variable or persistent.

Basic examples

The following example illustrates the instruction `Decr`:

See also [More examples on page 186](#).

Example 1

```
Decr reg1;  
1 is subtracted from reg1, that is reg1:=reg1-1.
```

Arguments

`Decr` Name | Dname

Name

Data type: num

The name of the variable or persistent to be decremented.

Dname

Data type: dnum

The name of the variable or persistent to be decremented.

More examples

More examples of the instruction `Decr` are illustrated below.

Example 1

```
VAR num no_of_parts:=0;  
...  
TPReadNum no_of_parts, "How many parts should be produced? ";  
WHILE no_of_parts>0 DO  
  produce_part;  
  Decr no_of_parts;  
ENDWHILE
```

The operator is asked to input the number of parts to be produced. The variable `no_of_parts` is used to count the number that still have to be produced.

Example 2

```
VAR dnum no_of_parts:=0;  
...  
TPReadDnum no_of_parts, "How many parts should be produced? ";  
WHILE no_of_parts>0 DO  
  produce_part;  
  Decr no_of_parts;  
ENDWHILE
```

The operator is asked to input the number of parts to be produced. The variable `no_of_parts` is used to count the number that still have to be produced.

Continues on next page

Syntax

Decr

[Name ':='] < var or pers (**INOUT**) of num >

| [Dname ':='] < var or pers (**INOUT**) of dnum > ' ;'

Related information

For information about	See
Incrementing a variable by 1	Incr - Increments by 1 on page 260
Subtracting any value from a variable	Add - Adds a numeric value on page 32
Changing data using an arbitrary expression, e.g. multiplication	":=" - Assigns a value on page 41

1 Instructions

1.68 DropSensor - Drop object on sensor

Machine Synchronization

1.68 DropSensor - Drop object on sensor

Usage

`DropSensor` is used to disconnect from the current object and the program is ready for the next.

`DropSensor` is used for sensor synchronization, but not for analog synchronization.

Basic example

```
MoveL *, v1000, z10, tool, \WObj:=wobj0;  
SyncToSensor Ssync1\Off;  
MoveL *, v1000, fine, tool, \WObj:=wobj0;  
DropSensor Ssync1;  
MoveL *, v1000, z10, tool, \WObj:=wobj0;
```

Arguments

`DropSensor MechUnit`

MechUnit

Mechanical Unit

Data type: mecunit

The moving mechanical unit to which the robot position in the instruction is related.

Program execution

Dropping the object means that the encoder unit no longer tracks the object. The object is removed from the object queue and cannot be recovered.

Limitations

If the instruction is issued while the robot is actively using the sensor object then the motion stops. The instruction must be issued after the robot has passed the last synchronized `robtarg`.

The instruction may be issued only after a non synchronized movement has been used in the preceding motion instructions with either a fine point or several (>1) corner zones.

Syntax

```
DropSensor  
[ MechUnit '[:=' ] < variable (VAR) of mecunit > '];'
```

Related information

For information about	See
Wait for connection on sensor	WaitSensor - Wait for connection on sensor on page 1067
Sync to sensor	SyncToSensor - Sync to sensor on page 854
<i>Machine Synchronization</i>	<i>Application manual - Controller software IRC5</i>

1.69 DropWObj - Drop work object on conveyor

Usage

`DropWObj` (*Drop Work Object*) is used to disconnect from the current object and the program is ready for the next object on the conveyor.

Basic examples

The following example illustrates the instruction `DropWObj`:

Example 1

```
MoveL *, v1000, z10, tool, \WObj:=wobj_on_cnv1;
MoveL *, v1000, fine, tool, \WObj:=wobj0;
DropWObj wobj_on_cnv1;
MoveL *, v1000, z10, tool, \WObj:=wobj0;
```

Arguments

`DropWObj WObj`

WObj

Work Object

Data type: `wobjdata`

The moving work object (coordinate system) to which the robot position in the instruction is related. The mechanical unit conveyor is to be specified by the `ufmec` in the work object.

Program execution

Dropping the work object means that the encoder unit no longer tracks the object. The object is removed from the object queue and cannot be recovered.

Limitations

If the instruction is issued while the robot is actively using the conveyor coordinated work object, then the motion stops.

The instruction may be issued only after a fixed work object has been used in the preceding motion instructions with either a fine point or several (>1) corner zones.

Syntax

```
DropWObj
[ WObj '[:=' ] < persistent (PERS) of wobjdata>';'
```

Related information

For information about	See
Wait for work objects	WaitWObj - Wait for work object on conveyor on page 1087
Conveyor tracking	<i>Application manual - Conveyor tracking</i>

1 Instructions

1.70 EOffsOff - Deactivates an offset for additional axes

RobotWare Base

1.70 EOffsOff - Deactivates an offset for additional axes

Usage

`EOffsOff` (*External Offset Off*) is used to deactivate an offset for additional axes.

The offset for additional axes is activated by the instruction `EOffsSet` or `EOffsOn` and applies to all movements until some other offset for additional axes is activated or until the offset for additional axes is deactivated.

This instruction can only be used in the main task `T_ROB1` or, if in a `MultiMove` system, in Motion tasks.

Basic examples

The following examples illustrate the instruction `EOffsOff`:

Example 1

```
EOffsOff;
```

Deactivation of the offset for additional axes.

Example 2

```
MoveL p10, v500, z10, tool1;  
EOffsOn \ExeP:=p10, p11;  
MoveL p20, v500, z10, tool1;  
MoveL p30, v500, z10, tool1;  
EOffsOff;  
MoveL p40, v500, z10, tool1;
```

An offset is defined as the difference between the position of each axis at `p10` and `p11`. This displacement affects the movement to `p20` and `p30`, but not to `p40`.

Program execution

Active offsets for additional axes are reset.

Syntax

```
EOffsOff ' ; '
```

Related information

For information about	See
Definition of offset using two positions	EOffsOn - Activates an offset for additional axes on page 191
Definition of offset using known values	EOffsSet - Activates an offset for additional axes using known values on page 193
Deactivation of the robot's program displacement	PDispOff - Deactivates program displacement on page 539

1.71 EOffsOn - Activates an offset for additional axes

Usage

EOffsOn (*External Offset On*) is used to define and activate an offset for additional axes using two positions.

This instruction can only be used in the main task T_ROB1 or, if in a MultiMove system, in Motion tasks.

Basic examples

The following examples illustrate the instruction EOffsOn:

See also [More examples on page 192](#).

Example 1

```
MoveL p10, v500, z10, tool1;
EOffsOn \ExeP:=p10, p20;
```

Activation of an offset for additional axes. This is calculated for each axis based on the difference between positions p10 and p20.

Example 2

```
MoveL p10, v500, fine \Inpos := inpos50, tool1;
EOffsOn *;
```

Activation of an offset for additional axes. Since a stop point that is accurately defined has been used in the previous instruction, the argument \ExeP does not have to be used. The displacement is calculated on the basis of the difference between the actual position of each axis and the programmed point (*) stored in the instruction.

Arguments

```
EOffsOn [\ExeP] ProgPoint
```

[\ExeP]

Executed Point

Data type: rotarget

The new position, used for calculation of the offset. If this argument is omitted, the current position of the axes at the time of the program execution is used.

ProgPoint

Programmed Point

Data type: rotarget

The original position of the axes at the time of programming.

Program execution

The offset is calculated as the difference between \ExeP and ProgPoint for each additional axis. If \ExeP has not been specified, the current position of the axes at the time of the program execution is used instead. Since it is the actual position of the axes that is used, the axes should not move when EOffsOn is executed.

Continues on next page

1 Instructions

1.71 EOffsOn - Activates an offset for additional axes

RobotWare Base

Continued

This offset is then used to displace the position of additional axes in subsequent positioning instructions and remains active until some other offset is activated (the instruction `EOffsSet` or `EOffsOn`) or until the offset for additional axes is deactivated (the instruction `EOffsOff`).

Only **one** offset for each individual additional axis can be activated at the same time. Several `EOffsOn`, on the other hand, can be programmed one after the other and, if they are, the different offsets will be added.

The additional axes offset is automatically reset:

- when using the restart mode **Reset RAPID**
- when loading a new program or a new module
- when starting program execution from the beginning
- when moving the program pointer to `main`
- when moving the program pointer to a routine
- when moving the program pointer in such a way that the execution order is lost.

More examples

More examples of how to use the instruction `EOffsOn` are illustrated below.

Example 1

```
SearchL sen1, psearch, p10, v100, tool1;  
PDispOn \ExeP:=psearch, *, tool1;  
EOffsOn \ExeP:=psearch, *;
```

A search is carried out in which the searched position of both the robot and the additional axes is stored in the position `psearch`. Any movement carried out after this starts from this position using a program displacement of both the robot and the additional axes. This is calculated based on the difference between the searched position and the programmed point (*) stored in the instruction.

Syntax

```
EOffsOn  
[ '\ ' ExeP ' := ' < expression (IN) of rotarget> ', ' ]  
[ ProgPoint ' := ' ] < expression (IN) of rotarget> ' ;'
```

Related information

For information about	See
Deactivation of offset for additional axes	EOffsOff - Deactivates an offset for additional axes on page 190
Definition of offset using known values	EOffsSet - Activates an offset for additional axes using known values on page 193
Displacement of the robot's movements	PDispOn - Activates program displacement on page 540
Coordinate systems	Technical reference manual - RAPID Overview

1.72 EOffset - Activates an offset for additional axes using known values

Usage

EOffset (*External Offset Set*) is used to define and activate an offset for additional axes using known values.

This instruction can only be used in the main task T_ROB1 or, if in a MultiMove system, in Motion tasks.

Basic examples

The following example illustrates the instruction EOffset:

Example 1

```
VAR extjoint eax_a_p100 := [100, 0, 0, 0, 0, 0];
...
EOffset eax_a_p100;
```

Activation of an offset `eax_a_p100` for additional axes, meaning (provided that the logical additional axis "a" is linear) that:

- The `ExtOffs` coordinate system is displaced 100 mm for the logical axis "a" (see figure below).
- As long as this offset is active, all positions will be displaced 100 mm in the direction of the x-axis.

The following figure shows displacement of an additional axis.

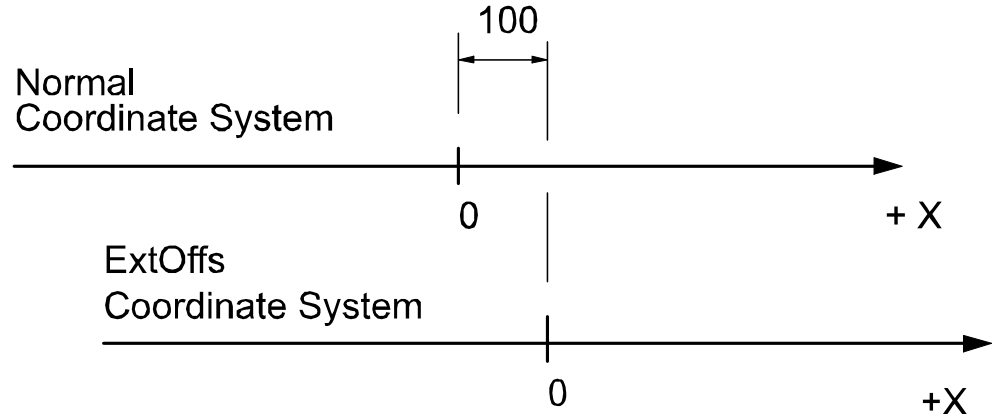

xx0500002162

Arguments

EOffset EAxOffs

EAxOffs

External Axes Offset

Data type: `extjoint`

The offset for additional axes is defined as data of the type `extjoint`, expressed in:

- mm for linear axes
- degrees for rotating axes

Continues on next page

1 Instructions

1.72 EOffsSet - Activates an offset for additional axes using known values

RobotWare Base

Continued

Program execution

The offset for additional axes is activated when the `EOffsSet` instruction is executed and remains active until some other offset is activated (the instruction `EOffsSet` or `EOffsOn`) or until the offset for additional axes is deactivated (the instruction `EOffsOff`).

Only one offset for additional axes can be activated at the same time. Offsets cannot be added to one another using `EOffsSet`.

The additional axes offset is automatically reset:

- when using the restart mode **Reset RAPID**
- when loading a new program or a new module
- when starting program execution from the beginning
- when moving the program pointer to `main`
- when moving the program pointer to a routine
- when moving the program pointer in such a way that the execution order is lost.

Syntax

```
EOffsSet  
  [ EAxOffs ':= ' ] < expression (IN) of extjoint> ';' 
```

Related information

For information about	See
Activate an offset for additional axes	EOffsOn - Activates an offset for additional axes on page 191
Deactivation of offset for additional axes	EOffsOff - Deactivates an offset for additional axes on page 190
Displacement of the robot's movements	PDispOn - Activates program displacement on page 540
Definition of data of the type <code>extjoint</code>	extjoint - Position of external joints on page 1665
Coordinate systems	Technical reference manual - RAPID Overview

1.73 EraseModule - Erase a module

Usage

`EraseModule` is used to remove a module from the program memory during execution.

There are no restrictions on how the module was loaded. It could have been loaded manually, from the configuration, or with a combination of the instructions `Load`, `StartLoad`, and `WaitLoad`.

The module cannot be defined as *Shared* in the configuration.

Basic examples

The following example illustrates the instruction `EraseModule`:

Example 1

```
EraseModule "PART_A";
```

Erase the program module `PART_A` from the program memory.

Arguments

```
EraseModule ModuleName
```

ModuleName

Data type: `string`

The name of the module that should be removed. Please note that this is the name of the module, not the name of the file.

Program execution

The program execution waits for the program module to finish the removal process before the execution proceeds with the next instruction.

When the program module is removed the rest of the program modules will be linked.

Error handling

The following recoverable errors can be generated. The errors can be handled in an **ERROR** handler. The system variable `ERRNO` will be set to:

Name	Cause of error
<code>ERR_MODULE</code>	The file in the <code>EraseModule</code> instruction cannot be removed because it was not found.

Limitations

It is not allowed to remove a program module that is executing.

Trap routines, system I/O events, and other program tasks cannot execute during the removal process.

Avoid ongoing robot movements during the removal.

Program stop during execution of `EraseModule` instruction results in guard stop with motors off and error message "20025 Stop order timeout" on the FlexPendant.

Continues on next page

1 Instructions

1.73 EraseModule - Erase a module

RobotWare Base

Continued

Syntax

```
EraseModule  
[ModuleName':=']<expression (IN) of string>;'
```

Related information

For information about	See
Unload a program module	UnLoad - Unload a program module during execution on page 1010
Load a program module in parallel with another program execution	StartLoad - Load a program module during execution on page 787 WaitLoad - Connect the loaded module to the task on page 1061
Accept unresolved reference	<i>Technical reference manual - System parameters, section Controller</i>

1.74 ErrLog - Write an error message

Usage

`ErrLog` is used to display an error message on the FlexPendant and write it in the event log. Error number and five error arguments must be stated. The message is stored in the process domain in the robot log. `ErrLog` can also be used to display warnings and information messages.

Basic examples

The following examples illustrate the instruction `ErrLog`:

Example 1

In case you do not want to make your own .xml file, you can use `ErrorId 4800` like in the example below:

```
VAR errstr my_title := "myerror";
VAR errstr str1 := "errortext1";
VAR errstr str2 := "errortext2";
VAR errstr str3 := "errortext3";
VAR errstr str4 := "errortext4";
ErrLog 4800, my_title, str1, str2, str3, str4;
```

On the FlexPendant the message will look like this:

```
Event Message: 4800
myerror
errortext1
errortext2
errortext3
errortext4
```

Example 2

An `ErrorId` must be declared in an .xml file. The number must be between 5000-9999. The error message is written in the .xml file and the arguments to the message is sent in by the `ErrLog` instruction. The `ErrorId` in the .xml file is the same stated in the `ErrLog` instruction.



Note

If using an `ErrorId` between 5000-9999 you have to install your own xml file.

Example of message in .xml file:

```
<Message number="5210" eDefine="ERR_INPAR_RDONLY">
  <Title>Parameter error</Title>
  <Description>Task:<arg format="%s" ordinal="1" />
    <p />Symbol <arg format="%s" ordinal="2" />is read-only
    <p />Context:<arg format="%s" ordinal="3" /><p />
  </Description>
</Message>
```

Continues on next page

1 Instructions

1.74 ErrLog - Write an error message

RobotWare Base

Continued

Example of instruction:

```
MODULE MyModule
  PROC main()
    VAR num errorid := 5210;
    VAR errstr arg := "Symbol P1 is read-only.";
    ErrLog errorid, ERRSTR_TASK, arg, ERRSTR_CONTEXT, ERRSTR_UNUSED,
      ERRSTR_UNUSED;
    ErrLog errorid \W, ERRSTR_TASK, arg, ERRSTR_CONTEXT,
      ERRSTR_UNUSED, ERRSTR_UNUSED;
  ENDPROC
ENDMODULE
```

On the FlexPendant the message will look like this:

Event Message: 5210

Parameter error

Task: T_ROB1

Symbol P1 is read-only.

Context: MyModule/main/ErrLog/(line number)

The first `ErrLog` instruction generates an error message. The message is stored in the robot log in the process domain. It is also shown on the FlexPendant display.

The second instruction is a warning. A message is stored in the robot log only.

The program will in both cases continue its execution when the instruction is done.

Arguments

```
ErrLog ErrorID [\W] | [\I] Argument1 Argument2 Argument3 Argument4
      Argument5
```

ErrorId

Data type: num

The number of a specific error that is to be monitored. The error number must be in interval 4800-4814 if using the preinstalled xml file, and between 5000 - 9999 if using an own xml file.

[\W]

Warning

Data type: switch

Gives a warning that is stored in the robot event log only (not shown directly on the FlexPendant display).

[\I]

Information

Data type: switch

Gives an information message that is stored in the event log only (not shown directly on the FlexPendant display).

If none of the arguments `\W` or `\I` are specified then the instruction will generate an error message directly on the flexpendant and also store it in the event log.

Continues on next page

Argument1

Data type: `errstr`

First argument in the error message. Any string or predefined data of type `errstr` can be used.

Argument2

Data type: `errstr`

Second argument in the error message. Any string or predefined data of type `errstr` can be used.

Argument3

Data type: `errstr`

Third argument in the error message. Any string or predefined data of type `errstr` can be used

Argument4

Data type: `errstr`

Fourth argument in the error message. Any string or predefined data of type `errstr` can be used.

Argument5

Data type: `errstr`

Fifth argument in the error message. Any string or predefined data of type `errstr` can be used.

Program execution

An error message (max 5 lines) is displayed on the FlexPendant and written in the event log.

If the optional argument `W` or optional argument `I` are used, a warning or an information message is written in the event log.

`ErrLog` generates program errors between 4800-4814 if using the xml file that are installed by the system, and between 5000-9999 if installing an own xml file. The error generated depends on the `ErrorID` indicated.

The message is stored in the process domain in the event log.

How to install an own xml file is described in *Application manual - RobotWare Add-Ins*.

Limitations

Total string length (Argument1-Argument5) is limited to 195 characters.

Syntax

```
ErrLog
  [ErrorId ':='] < expression (IN) of num> ', '
  [ '\W ] | [ '\ I ] ', '
  [Argument1 ':='] < expression (IN) of errstr> ', '
  [Argument2 ':='] < expression (IN) of errstr> ', '
  [Argument3 ':='] < expression (IN) of errstr> ', '
```

Continues on next page

1 Instructions

1.74 ErrLog - Write an error message

RobotWare Base

Continued

```
[Argument4 ':='] < expression (IN) of errstr> ','  
[Argument5 ':='] < expression (IN) of errstr> ';' 
```

Related information

For information about	See
Predefined data of type <code>errstr</code>	errstr - Error string on page 1661
Display message on the FlexPendant	TPWrite - Writes on the FlexPendant on page 880 UIMsgBox - User Message Dialog Box type basic on page 992
Event log	<i>Operating manual - IRC5 with FlexPendant</i>
Event log messages, explanation of xml-file	<i>Application manual - RobotWare Add-Ins</i>
How to install XML files when using add-ins	<i>Application manual - RobotWare Add-Ins</i>

1.75 ErrRaise - Writes a warning and calls an error handler

Usage

`ErrRaise` is used to create an error in the program and then call the error handler of the routine. A warning is written in the event log. `ErrRaise` can also be used in the error handler to propagate the current error to the error handler of the calling routine.

Error name, error number, and five error arguments must be stated. The message is stored in the *Process* category in the event log.

Basic examples

The following examples illustrate the instruction `ErrRaise`:

Example 1

In case you do not want to make your own .xml file, you can use `ErrorId 4800` like in the example below:

```
MODULE MyModule
  VAR errnum ERR_BATT:=-1;
  PROC main()
    VAR num errorid := 4800;
    VAR errstr my_title := "Backup battery status";
    VAR errstr str1 := "Bacup battery is fully charged";
    BookErrNo ERR_BATT;
    ErrRaise "ERR_BATT", errorid, my_title, ERRSTR_TASK, str1,
            ERRSTR_CONTEXT,ERRSTR_EMPTY;
    ERROR
    IF ERRNO = ERR_BATT THEN
      TRYNEXT;
    ENDIF
  ENDPROC
ENDMODULE
```

On the FlexPendant the message will look like this (warning and/or an error):

Event Message: 4800

Backup battery status

Task: main

Backup battery is fully charged

Context: MyModule/main/ErrRaise

An error number must be booked with the instruction `BookErrNo`. Corresponding string is stated as the first argument, `ErrorName`, in the `ErrRaise`.

`ErrRaise` creates an error and then calls the error handler. If the error is taken care of, a warning is generated in the event log, in the process domain. Otherwise a fatal error is generated and the program stops.

`ErrRaise` can also be used in an error handler in a subroutine. In this case the execution continues in the error handler of the calling routine.

Continues on next page

1 Instructions

1.75 ErrRaise - Writes a warning and calls an error handler

RobotWare Base

Continued

Example 2

An `ErrorId` must be declared in an `.xml` file. The number must be between 5000 - 9999. The error message is written in the `.xml` file and the arguments to the message are sent in by the `ErrRaise` instruction. The `ErrorId` in the `.xml` file is the same stated in the `ErrRaise` instruction.

NOTE: If using an `ErrorId` between 5000-9999 you have to install your own `xml` file.

Example of message in `.xml` file:

```
<Message number="7055" eDefine="SYS_ERR_ARL_INPAR_RDONLY">
  <Title>Parameter error</Title>
  <Description>Task:<arg format="%s" ordinal="1" />
    <p />Symbol <arg format="%s" ordinal="2" />is read-only
    <p />Context:<arg format="%s" ordinal="3" /><p /></Description>
</Message>
```

Example of instruction:

```
MODULE MyModule
  VAR errnum ERR_BATT:=-1;
  PROC main()
    VAR num errorid := 7055;
    BookErrNo ERR_BATT;
    ErrRaise "ERR_BATT", errorid, ERRSTR_TASK,
      ERRSTR_CONTEXT,ERRSTR_UNUSED, ERRSTR_UNUSED,
      ERRSTR_UNUSED;

    ERROR
    IF ERRNO = ERR_BATT THEN
      TRYNEXT;
    ENDIF
  ENDPROC
ENDMODULE
```

On the FlexPendant the message will look like this (warning and/or an error):

Event Message: 7055

Backup battery status

Task: main

Backup battery is fully charged

Context: MyModule/main/ErrRaise

An error number must be booked with the instruction `BookErrNo`. Corresponding string is stated as the first argument, `ErrorMessage`, in the `ErrRaise`.

`ErrRaise` creates an error and then calls the error handler. If the error is taken care of, a warning is generated in the event log, in the process domain. Otherwise a fatal error is generated and the program stops.

`ErrRaise` can also be used in an error handler in a subroutine. In this case the execution continues in the error handler of the calling routine.

Arguments

```
ErrRaise ErrorMessage ErrorId Argument1 Argument2 Argument3 Argument4
Argument5
```

Continues on next page

ErrorName

Data type: string

An error number must be booked using the instruction `BookErrNo`. Corresponding variable is stated as `ErrorName`.

ErrorId

Data type: num

The number of a specific error that is to be monitored. The error number must be in interval 4800-4814 if using the preinstalled xml file, and between 5000 - 9999 if using an own xml file.

Argument1

Data type: errstr

First argument in the error message. Any string or predefined data of type `errstr` can be used.

Argument2

Data type: errstr

Second argument in the error message. Any string or predefined data of type `errstr` can be used.

Argument3

Data type: errstr

Third argument in the error message. Any string or predefined data of type `errstr` can be used

Argument4

Data type: errstr

Fourth argument in the error message. Any string or predefined data of type `errstr` can be used.

Argument5

Data type: errstr

Fifth argument in the error message. Any string or predefined data of type `errstr` can be used.

Program execution

`ErrRaise` generates program warnings between 4800-4814 if using the xml file that are installed by the system, and between 5000-9999 if installing an own xml file. The error generated depends on the `ErrorID` indicated. A warning is written in the robot message log in the domain process.

When the `ErrRaise` is executed the behavior depends on where it is executed:

- When executing instruction in the routine body, a warning is generated, and the execution continues in the error handler.
- When executing instruction in an error handler, the old warning is skipped, a new one is generated, and the control is raised to calling instruction.

Continues on next page

1 Instructions

1.75 ErrRaise - Writes a warning and calls an error handler

RobotWare Base

Continued

More examples

More examples of how to use the instruction `ErrRaise` are illustrated below.

Example 1

```
VAR errnum ERR_BATT:=-1;
VAR errnum ERR_NEW_ERR:=-1;

PROC main()
  testerrraise;
ENDPROC

PROC testerrraise()
  BookErrNo ERR_BATT;
  BookErrNo ERR_NEW_ERR;
  ErrRaise "ERR_BATT", 7055, ERRSTR_TASK, ERRSTR_CONTEXT,
    ERRSTR_UNUSED, ERRSTR_UNUSED, ERRSTR_UNUSED;
  ERROR
  IF ERRNO = ERR_BATT THEN
    ErrRaise "ERR_NEW_ERR", 7156, ERRSTR_TASK, ERRSTR_CONTEXT,
      ERRSTR_UNUSED, ERRSTR_UNUSED, ERRSTR_UNUSED;
  ENDIF
ENDPROC
```

Generate new warning 7156 from error handler. Raise control to calling routine and stop execution.

Limitations

Total string length (Argument1-Argument5) is limited to 195 characters.

Syntax

```
ErrRaise
  [ErrorName ':='] < expression (IN) of string> ', '
  [ErrorId ':='] < expression (IN) of num> ', '
  [Argument1 ':='] < expression (IN) of errstr> ', '
  [Argument2 ':='] < expression (IN) of errstr> ', '
  [Argument3 ':='] < expression (IN) of errstr> ', '
  [Argument4 ':='] < expression (IN) of errstr> ', '
  [Argument5 ':='] < expression (IN) of errstr> ';'
```

Related information

For information about	See
Predefined data of type <code>errstr</code>	errstr - Error string on page 1661
Booking error numbers	BookErrNo - Book a RAPID system error number on page 49
Error handling	<i>Technical reference manual - RAPID Overview</i>
<i>Advanced RAPID</i>	<i>Application manual - Controller software IRC5</i>

1.76 ErrWrite - Write an error message

Usage

`ErrWrite` (*Error Write*) is used to display an error message on the FlexPendant and write it in the event log. It can also be used to display warnings and information messages.

Basic examples

The following examples illustrate the instruction `ErrWrite`:

Example 1

```
ErrWrite "PLC error", "Fatal error in PLC" \RL2:="Call service";
Stop;
```

A message is stored in the robot log. The message is also shown on the FlexPendant display.

Example 2

```
ErrWrite \W, "Search error", "No hit for the first search";
RAISE try_search_again;
```

A message is stored in the robot log only. Program execution then continues.

Arguments

```
ErrWrite [ \W ] | [ \I ] Header Reason [ \RL2 ] [ \RL3 ] [ \RL4 ]
```

[\W]

Warning

Data type: `switch`

Gives a warning that is stored in the robot error message log only (not shown directly on the FlexPendant display).

[\I]

Information

Data type: `switch`

Gives an information message that is stored in the event log only (not shown directly on the FlexPendant display).

If none of the arguments `\W` or `\I` are specified then the instruction will generate an error message directly on the flexpendant and also store it in the event log.

Header

Data type: `string`

Error message heading (max. 46 characters).

Reason

Data type: `string`

Reason for error.

[\RL2]

Reason Line 2

Continues on next page

1 Instructions

1.76 ErrWrite - Write an error message

RobotWare Base

Continued

Data type: string

Reason for error.

[\RL3]

Reason Line 3

Data type: string

Reason for error.

[\RL4]

Reason Line 4

Data type: string

Reason for error.

Program execution

An error message (max. 5 lines) is displayed on the FlexPendant and written in the robot message log.

In the case of argument \W or argument \I a warning or an information message is written in the event log.

ErrWrite generates the program error no. 80001 for an error, no. 80002 for a warning (\W) and no. 80003 for an information message (\I).

Limitations

Total string length (Header+Reason+\RL2+\RL3+\RL4) is limited to 195 characters.

Syntax

```
ErrWrite
[ '\W ] | [ '\ I ] ','
[ Header ':' ] < expression (IN) of string>','
[ Reason ':' ] < expression (IN) of string>
[ '\RL2 ':' ] < expression (IN) of string> ]
[ '\RL3 ':' ] < expression (IN) of string> ]
[ '\RL4 ':' ] < expression (IN) of string> ] ';'

```

Related information

For information about	See
Predefined data of type errstr	errstr - Error string on page 1661
Display message on the FlexPendant	TPWrite - Writes on the FlexPendant on page 880 UIMsgBox - User Message Dialog Box type basic on page 992
Event log	Operating manual - IRC5 with FlexPendant
Write error message - Err Log	ErrLog - Write an error message on page 197

1.77 EXIT - Terminates program execution

Usage

`EXIT` is used to terminate program execution. Program restart will then be blocked, that is the program can only be restarted from the first instruction of the main routine.

The `EXIT` instruction should be used when fatal errors occur or when program execution is to be stopped permanently. The `Stop` instruction is used to temporarily stop program execution. After execution of the instruction `EXIT` the program pointer is gone. To continue program execution, the program pointer must be set.

Basic examples

The following example illustrates the instruction `EXIT`:

Example 1

```
ErrWrite "Fatal error","Illegal state";  
EXIT;
```

Program execution stops and cannot be restarted from that position in the program.

Syntax

```
EXIT ';' ;
```

Related information

For information about	See
Stopping program execution temporarily	Stop - Stops program execution on page 815

1 Instructions

1.78 ExitCycle - Break current cycle and start next

RobotWare Base

1.78 ExitCycle - Break current cycle and start next

Usage

`ExitCycle` is used to break the current cycle and move the program pointer (PP) back to the first instruction in the main routine.

If the program is executed in continuous mode, it will start to execute the next cycle.

If the execution is in cycle mode, the execution will stop at the first instruction in the main routine.

Basic examples

The following example illustrates the instruction `ExitCycle`:

Example 1

```
VAR num cyclecount:=0;
VAR intnum error_intno;

PROC main()
  IF cyclecount = 0 THEN
    CONNECT error_intno WITH error_trap;
    ISignalDI di_error,1,error_intno;
  ENDIF
  cyclecount:=cyclecount+1;
  ! start to do something intelligent
  ...
ENDPROC

TRAP error_trap
  TPWrite "ERROR, I will start on the next item";
  ExitCycle;
ENDTRAP
```

This will start the next cycle if the signal `di_error` is set.

Program execution

Execution of the instruction `ExitCycle` in a program task controlling mechanical units results in the following in the actual task:

- On-going robot movements stops.
- All robot paths that are not performed at all path levels (both normal and `StorePath` level) are cleared.
- All instructions that are started but not finished at all execution levels (both normal and trap level) are interrupted.
- The program pointer is moved to the first instruction in the main routine.
- The program execution continues to execute the next cycle.

Continues on next page

1.78 ExitCycle - Break current cycle and start next RobotWare Base Continued

Execution of the instruction `ExitCycle` in some other program task, not controlling mechanical units, results in the following in the actual task:

- All instructions that are started but not finished on all execution levels (both normal and trap level) are interrupted.
- The program pointer is moved to the first instruction in the main routine.
- The program execution continues to execute the next cycle.

All other modal things in the program and system are **not** affected by `ExitCycle` such as:

- The actual value of variables or persistents.
- Any motion settings such as `StorePath-RestoPath` sequence, world zones, and so on.
- Open files, directories, and so on.
- Defined interrupts, and so on.

When using `ExitCycle` in routine calls and the entry routine is defined with “Move PP to Routine ...” or “Call Routine ...”, `ExitCycle` breaks the current cycle and moves the program pointer back to the first instruction in the entry routine (instead of the main routine as specified previously).

Syntax

```
ExitCycle';'
```

Related information

For information about	See
Stopping after a fatal error	EXIT - Terminates program execution on page 207
Terminating program execution	EXIT - Terminates program execution on page 207
Stopping for program actions	Stop - Stops program execution on page 815
Finishing execution of a routine	RETURN - Finishes execution of a routine on page 621

1 Instructions

1.79 FitCircle - Fits a circle to 3D-points

RobotWare Base

1.79 FitCircle - Fits a circle to 3D-points

Usage

`FitCircle` is used to fit a circle to a set of 3D-points.

Basic examples

The following examples illustrate the instruction `FitCircle`.

Example 1

```
VAR pos points{3}:=[ [2.000264140454799, -1.948606082287765, 3],
                    [10.666326255802462, 1.399713485871053, 3],
                    [9.609499187363362, 2.265033879249959, 3]];
VAR num radius;
VAR pos center;
VAR pos normal;
FitCircle points, center, radius, normal;
```

With only three points specified, `FitCircle` calculates a circle that passes exactly through all the points. In this example, the resulting circle is:

```
center = [7,-2,3]
radius = 5
normal = [0,0,1]
```

In this simple example, all the 3D-points have the same z-coordinate and therefore the identified circle must be in the xy-plane. In the general case, the method will identify the plane that contains the circle. The plane is described by the returned normal, which is a unit vector perpendicular to the circle.

The circle and the input points are shown in the figure below.

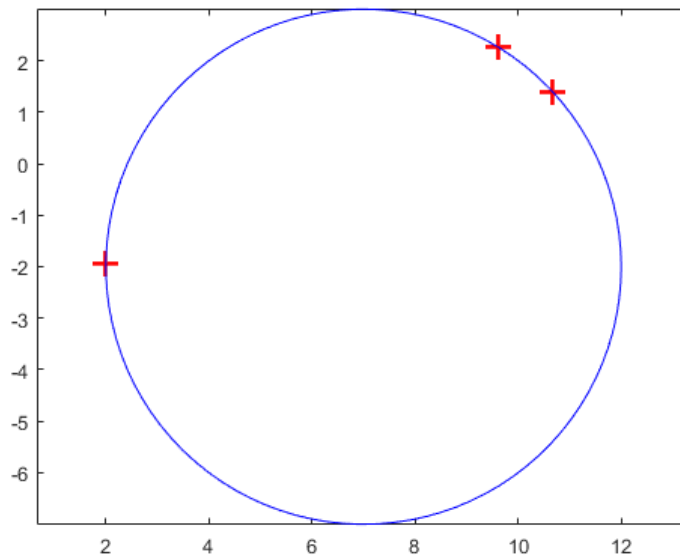

xx1700000731

Example 2

```
VAR pos points{10}:=[
```

Continues on next page

```
[-7.2, -5.254055558738700, 3.307061712883007],  
[-7.2, -3.211963764808295, 3.090792209685409],  
[-7.2, -5.650784519354138, 4.074184087507510],  
[-7.2, -4.261241341238363, 3.549808031134106],  
[-7.2, -3.780658372123544, 12.570750298513245],  
[-7.2, 1.309442476421255, 11.013856026376601],  
[-7.2, -4.649041803426594, 3.435039251520052],  
[-7.2, 1.403058916454365, 6.576147932013719],  
[-7.2, -7.546395053424201, 9.841667138860654],  
[-7.2, -2.490309697793828, 2.788705869634919];
```

```
VAR pos center;  
VAR num radius;  
VAR pos normal;  
VAR num rms;  
VAR num maxErr;  
VAR num indexWorst;
```

```
FitCircle points, center, radius, normal \RMS:=rms \MaxErr:=maxErr  
\IndexWorst:=indexWorst;
```

In this case a circle is fitted to ten points that do not lie on a circle. The result is a circle that fits the points in a least-squares sense. To simplify the example, the points are all in a plane parallel to the yz-plane.

The resulting circle is:

```
center = [-7.2,-2.92489,7.96317]  
radius = 4.88656  
normal = [1,0,0]
```

The error parameters of the fit are:

```
rms = 0.2387  
maxErr = 0.3418  
indexWorst = 8
```

1 Instructions

1.79 FitCircle - Fits a circle to 3D-points

RobotWare Base

Continued

The circle and the input points are shown in the figure below.

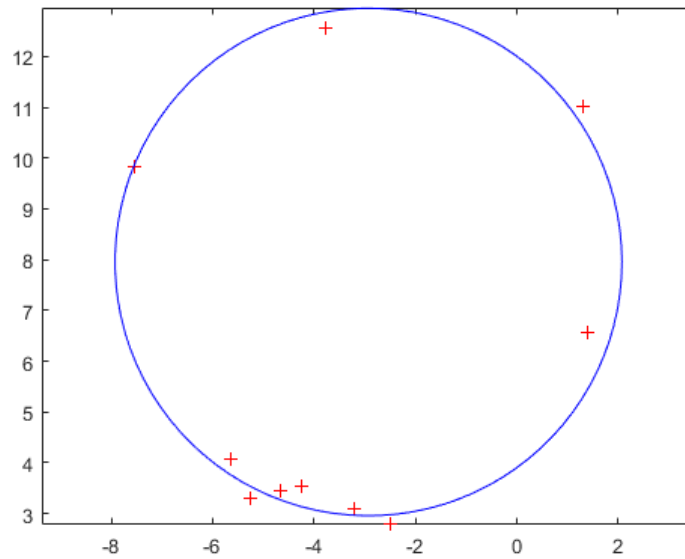

xx1700000732

Arguments

FitCircle Points [\NumPoints] Center Radius Normal [\RMS] [\MaxErr]
[\IndexWorst]

Points

Data type: array of pos

Points is an array containing the 3D-points for the circle fit.

[\NumPoints]

Data type: num

With the optional argument NumPoints it is possible to specify how many of the points that shall be used. If omitted, then all points in the array Points are used.

Center

Data type: pos

The center of the resulting circle.

Radius

Data type: num

The radius of the resulting circle.

Normal

Data type: pos

A unit-length vector that is perpendicular to the plane of the identified circle.

[\RMS]

Data type: num

Optional argument that contains the root-mean-square error of the circle fit.

Continues on next page

[\MaxErr]

Data type: num

Optional argument that contains the maximum distance between the resulting circle and the input points.

[\IndexWorst]

Data type: num

Optional argument that contains the index of the point that has the maximum distance to the circle.

Program execution

FitCircle fits a circle to a set of 3D-points.

Error handling

The following recoverable errors are generated and can be handled in an error handler. The system variable `ERRNO` will be set to:

ERR_FIT_NUMPOINTS	Parameter NumPoints larger than array Points.
ERR_FIT_TOO_FEW_POINTS	Too few points, $n < 3$.
ERR_FIT_TOO_MANY_POINTS	Too many points, $n > 100$.
ERR_FIT_POINTS_IN_LINE	Identical points or collinear points and $n = 3$.
ERR_FIT_NOT_PLANE	Points are not on a plane (linear or spherical distribution).

Limitations

If the input points are not possible to fit a circle, an event log is presented and the result cannot be used.

Syntax

```
FitCircle
[ Points ':=' ] <array {*} expression (IN) of dnum> ', '
[ '\ NumPoints ':=' < expression (IN) of num> ] ', '
[ Center ':=' ] <variable (VAR) of pos> ', '
[ Radius ':=' ] <variable (VAR) of num> ', '
[ Normal ':=' ] <variable (VAR) of pos>
[ '\ RMS ':=' <variable (VAR) of num> ]
[ '\ MaxErr ':=' <variable (VAR) of num> ]
[ '\ IndexWorst ':=' <variable (VAR) of num> ] ';'

```

Related information

For information about	See
Mathematical instructions and functions.	<i>Technical reference manual - RAPID Overview</i>

1 Instructions

1.80 FitLine - Fits a line to a set of points

RobotWare Base

1.80 FitLine - Fits a line to a set of points

Usage

`FitLine` is used to create a least squares fit of a line to a set of points.

Arguments

```
FitLine Points [\NumPoints] P V [\RMS] [\MaxErr] [\IndexWorst]
```

Points

Data type: array of pos

Points is an array of points for identifying the line.

[\NumPoints]

Data type: num

With the optional argument `NumPoints` it is possible to specify how many of the points that shall be used. If omitted, then all points in the array `Points` are used.

P

Data type: pos

A point in the identified line.

V

Data type: num

The unit-length direction vector for the line.

[\RMS]

Data type: num

Optional argument that contains the root-mean-square error of the line fit.

[\MaxErr]

Data type: num

Optional argument that contains the maximum distance between the points and identified line.

[\IndexWorst]

Data type: num

Optional argument that contains the index of the point that causes the largest error in the fit.

Program execution

`FitLine` creates a least squares fit of a line to a set of points. If the parameter `NumPoints` is omitted, all points in the array are used. The method requires at least two points to be able to identify a line. The returned line is represented as a point `P` and a unit-length direction vector `V`.

Continues on next page

Error handling

The following recoverable errors are generated and can be handled in an error handler. The system variable `ERRNO` will be set to:

<code>ERR_FIT_NUMPOINTS</code>	Parameter <code>NumPoints</code> larger than array <code>Points</code> .
<code>ERR_FIT_TOO_FEW_POINTS</code>	Too few points, $n < 2$.
<code>ERR_FIT_POINTS_TOO_CLOSE</code>	Identical points and $n = 2$.
<code>ERR_FIT_POINTS_NOT_LINE</code>	Points are not along a line (planar or spherical distribution).

Limitations

If the input points are not possible to fit a line, an event log is presented and the result cannot be used.

Syntax

```
FitLine
  [ Points ':=' ] <array {*} expression (IN) of dnum> ', '
  [ '\ NumPoints ':=' < expression (IN) of num> ] ', '
  [ P ':=' ] <variable (VAR) of pos>
  [ V ':=' <variable (VAR) of num> ]
  [ '\ RMS ':=' <variable (VAR) of num> ]
  [ '\ MaxErr ':=' <variable (VAR) of num> ]
  [ '\ IndexWorst ':=' <variable (VAR) of num> ] ';'

```

Related information

For information about	See
Mathematical instructions and functions.	<i>Technical reference manual - RAPID Overview</i>

1 Instructions

1.81 FitPlane - Fits a plane to a set of points

RobotWare Base

1.81 FitPlane - Fits a plane to a set of points

Usage

`FitPlane` is used to create a least squares fit of a plane to a set of points.

Arguments

`FitPlane Points [\NumPoints] P Normal [\RMS] [\MaxErr] [\IndexWorst]`

`Points`

Data type: array of pos

`Points` is an array containing the points for the plane.

`[\NumPoints]`

Data type: num

With the optional argument `NumPoints` it is possible to specify how many of the points that shall be used. If omitted, then all points in the array `Points` are used.

`P`

Data type: pos

A point in the identified plane.

`Normal`

Data type: pos

A unit-length vector for the plane.

`[\RMS]`

Data type: num

Optional argument that contains the root-mean-square error of the plane.

`[\MaxErr]`

Data type: num

Optional argument that contains the maximum distance between the points and the identified plane.

`[\IndexWorst]`

Data type: num

Optional argument that contains the index of the point that causes the largest error in the fit.

Program execution

`FitPlane` creates a least squares fit of a plane to a set of points. If the parameter `NumPoints` is omitted, all points in the array are used. The method requires at least three points to be able to identify a plane. The returned plane is represented as a point `P` and a unit-length normal vector.

Continues on next page

Error handling

The following recoverable errors are generated and can be handled in an error handler. The system variable `ERRNO` will be set to:

<code>ERR_FIT_NUMPOINTS</code>	Parameter <code>NumPoints</code> larger than array <code>Points</code> .
<code>ERR_FIT_TOO_FEW_POINTS</code>	Too few points, $n < 3$.
<code>ERR_FIT_POINTS_IN_LINE</code>	Identical points or collinear points and $n = 3$.
<code>ERR_FIT_NOT_PLANE</code>	Points are not on a plane (linear or spherical distribution).

Limitations

If the input points are not possible to fit a plane, an event log is presented and the result cannot be used.

Syntax

```
FitPlane
[ Points ':=' ] <array {*} expression (IN) of dnum> ', '
[ '\ NumPoints ':=' < expression (IN) of num> ] ', '
[ P ':=' ] <variable (VAR) of pos> ', '
[ Normal ':=' ] <variable (VAR) of pos>
[ '\ RMS ':=' <variable (VAR) of num> ]
[ '\ MaxErr ':=' <variable (VAR) of num> ]
[ '\ IndexWorst ':=' <variable (VAR) of num> ] ';'

```

Related information

For information about	See
Mathematical instructions and functions.	<i>Technical reference manual - RAPID Overview</i>

1 Instructions

1.82 FitSphere - Fit a sphere to a set of points

RobotWare Base

1.82 FitSphere - Fit a sphere to a set of points

Usage

`FitSphere` is used to create a least squares fit of a sphere to a set of points.

Arguments

```
FitSphere Points [\NumPoints] Center Radius [\RMS] [\MaxErr]
           [\IndexWorst]
```

Points

Data type: array of pos

`Points` is an array containing the 3D-points for the sphere.

[\NumPoints]

Data type: num

With the optional argument `NumPoints` it is possible to specify how many of the points that shall be used. If omitted, then all points in the array `Points` are used.

Center

Data type: pos

The center of the resulting sphere.

Radius

Data type: num

The radius of the resulting sphere.

[\RMS]

Data type: num

Optional argument that contains the root-mean-square error of the sphere fit.

[\MaxErr]

Data type: num

Optional argument that contains the maximum distance between the resulting sphere and the input points.

[\IndexWorst]

Data type: num

Optional argument that contains the index of the point that has the maximum distance to the sphere.

Program execution

`FitSphere` creates a least squares fit of a sphere to a set of points. If the parameter `NumPoints` is omitted, then all points in the array are used. The method requires at least four points to be able to identify a sphere.

Continues on next page

Error handling

The following recoverable errors are generated and can be handled in an error handler. The system variable `ERRNO` will be set to:

<code>ERR_FIT_NUMPOINTS</code>	Parameter <code>NumPoints</code> larger than array <code>Points</code> .
<code>ERR_FIT_TOO_FEW_POINTS</code>	Too few points, $n < 3$.
<code>ERR_FIT_TOO_MANY_POINTS</code>	Too many points, $n > 100$.
<code>ERR_FIT_POINTS_IN_LINE</code>	All points are on a line (bad input).

Limitations

If the input points are not possible to fit a sphere, an event log is presented and the result cannot be used.

Syntax

```
FitSphere
[ Points := ] <array {*} expression (IN) of dnum> ', '
[ '\ NumPoints := < expression (IN) of num> ] ', '
[ Center := ] <variable (VAR) of pos> ', '
[ Radius := ] <variable (VAR) of num> ', '
[ '\ RMS := <variable (VAR) of num> ]
[ '\ MaxErr := <variable (VAR) of num> ]
[ '\ IndexWorst := <variable (VAR) of num> ] ';'

```

Related information

For information about	See
Mathematical instructions and functions.	<i>Technical reference manual - RAPID Overview</i>

1 Instructions

1.83 FOR - Repeats a given number of times

RobotWare Base

1.83 FOR - Repeats a given number of times

Usage

FOR is used when one or several instructions are to be repeated a number of times.

Basic examples

The following examples illustrate the instruction FOR:

See also [More examples on page 221](#).

Example 1

```
FOR i FROM 1 TO 10 DO
  routinel;
ENDFOR
```

Repeats the `routinel` procedure 10 times.

Arguments

```
FOR Loop counter FROM Start value TO End value [STEP Step value]
DO ... ENDFOR
```

Loop counter

Identifier

The name of the data that will contain the value of the current loop counter. The data is declared automatically.

If the loop counter name is the same as any data that already exists in the actual scope, the existing data will be hidden in the FOR loop and not affected in any way.

Start value

Data type: Num

The desired start value of the loop counter. (usually integer values)

End value

Data type: Num

The desired end value of the loop counter. (usually integer values)

Step value

Data type: Num

The value by which the loop counter is to be incremented (or decremented) each loop. (usually integer values)

If this value is not specified, the step value will automatically be set to 1 (or -1 if the start value is greater than the end value).

Program execution

- 1 The expressions for the start, end, and step values are evaluated.
- 2 The loop counter is assigned the start value.
- 3 The value of the loop counter is checked to see whether its value lies between the start and end value, or whether it is equal to the start or end value. If the

Continues on next page

value of the loop counter is outside of this range, the FOR loop stops and program execution continues with the instruction following ENDFOR.

- 4 If a Break is executed in the FOR loop, the loop is interrupted and the execution continues after the FOR loop.
- 5 If a Continue is executed in the FOR loop, the rest of the statements in the loop are disregarded, and the execution continues in the beginning of the FOR loop.
- 6 The instructions in the FOR loop are executed.
- 7 The loop counter is incremented (or decremented) in accordance with the step value.
- 8 The FOR loop is repeated, starting from point 3.

More examples

More examples of how to use the instruction FOR are illustrated below.

Example 1

```
FOR i FROM 10 TO 2 STEP -2 DO
  a{i} := a{i-1};
ENDFOR
```

The values in an array are adjusted upwards so that $a\{10\}:=a\{9\}$, $a\{8\}:=a\{7\}$ and so on.

Example 2

```
FOR i FROM 10 TO 2 STEP -2 DO
  a{i} := a{i-1};
  IF di_1 = 1 THEN
    BREAK; ! Leave the loop if di_1 is set
  ENDIF
ENDFOR
```

Example 3

```
FOR i FROM 10 TO 2 STEP -2 DO
  IF i = 6 THEN
    CONTINUE; ! Don't set value for a[6]. Continue with the next
    loop
  ENDIF
  a{i} := a{i-1};
ENDFOR
```

Limitations

The loop counter (of data type num) can only be accessed from within the FOR loop and consequently hides other data and routines that have the same name. It can only be read (not updated) by the instructions in the FOR loop.

Decimal values for start, end, or stop values, in combination with exact termination conditions for the FOR loop, cannot be used (undefined whether or not the last loop is running).

Continues on next page

1 Instructions

1.83 FOR - Repeats a given number of times

RobotWare Base

Continued

Remarks

If the number of repetitions is to be repeated as long as a given expression is evaluated to a `TRUE` value, the `WHILE` instructions should be used instead.

Syntax

```
FOR <loop variable> FROM <expression> TO <expression>
  [ STEP <expression> ] DO
  <statement list>
ENDFOR
```

Related information

For information about	See
Expressions	<i>Technical reference manual - RAPID Overview</i>
Repeats as long as...	WHILE - Repeats as long as ... on page 1091
Identifiers	<i>Technical reference manual - RAPID Overview</i>

1.84 FricIdInit - Initiate friction identification

Usage

`FricIdInit` marks the starting point of a sequence of move instructions that will be repeated to calculate the robot's internal friction.

Example

Basic example where a circle movement is used to calculate the robot's internal friction for this movement.

```

PERS num friction_levels{6};

! Start of the friction calculation sequence
FricIdInit;

! Execute the move sequence
MoveC p10, p20, Speed, z0, Tool;
MoveC p30, p40, Speed, z0, Tool;

! Repeat the sequence and calculate the friction
FricIdEvaluate friction_levels;

! Activate compensation for the calculated friction levels
FricIdSetFricLevels friction_levels;

```

Prerequisites

The system parameter *Friction FFW On* must be set to TRUE. Otherwise the instruction `FricIdInit` will do nothing.

Limitations

- `FricIdInit` only works for TCP robots.
- Can only be executed from motion tasks.
- The robot must move on the basic path level.
- Friction tuning cannot be combined with synchronized movement. That is, `SyncMoveOn` is not allowed between `FricIdInit` and `FricIdEvaluate`.
- The movement sequence for which friction tuning is done must begin and end with a finepoint. If not, finepoints will automatically be inserted during the tuning process.

Syntax

```
FricIdInit ';' ;
```

Related information

For information about	See
<i>Advanced robot motion</i>	<i>Application manual - Controller software IRC5</i>

1 Instructions

1.85 FricIdEvaluate - Evaluate friction identification

Advanced Shape Tuning

1.85 FricIdEvaluate - Evaluate friction identification

Usage

`FricIdEvaluate` makes the robot repeat the movement between the instructions `FricIdInit` and `FricIdEvaluate` while calculating the friction for each axis of the robot.

Example

Basic example where a circle movement is used to calculate the robot's internal friction for this movement.

```
PERS num friction_levels{6};

! Start of the friction calculation sequence
FricIdInit;

! Execute the move sequence
MoveC p10, p20, Speed, z0, Tool;
MoveC p30, p40, Speed, z0, Tool;

! Repeat the sequence and calculate the friction
FricIdEvaluate friction_levels;

! Activate compensation for the calculated friction levels
FricIdSetFricLevels friction_levels;
```

Arguments

```
FricIdEvaluate FricLevels [\MechUnit] [\BwdSpeed] [\NoPrint]
[\FricLevelMax] [\FricLevelMin] [\OptTolerance]
```

`FricLevels`

Friction levels

Data type: array of num

When `FricIdEvaluate` is finished, the array `FricLevels` will contain the tuned friction levels for all axes of the robot. This array must be declared to have as many elements as the robot has axes. Note that the instruction `FricIdSetFricLevels` must be called for these values to have effect.

`[\MechUnit]`

Mechanical unit

Data type: mecunit

The argument `MechUnit` is optional. If it is omitted, friction tuning will be done for the mechanical unit represented by the predefined RAPID variable `ROB_ID`, which is a reference to the TCP robot in the current program task. Friction compensation is only possible for TCP robots.

`[\BwdSpeed]`

Backward speed

Data type: speeddata

Continues on next page

After each iteration in the tuning process, the robot moves backward along the programmed path. By default the backward movement is done at the programmed speed. To speed up the process, the optional argument `BwdSpeed` can be used to specify a higher speed during the backward movement. This will *not* influence the tuning result.

`[\NoPrint]`

Data type: `switch`

If the argument `NoPrint` is used, no text is written on the FlexPendant about the progress of the iterations of the friction identification.

`[\FricLevelMax]`

Friction level max

Data type: `num`

Normally, the optimal friction value is found by trying values between 1% and 500% of the configured friction value. In rare cases this can generate an error message (Joint speed error). To avoid this, use the argument `FricLevelMax` and set it to a value lower than 500. For example, if `FricLevelMax` is set to 400, values between 1% and 400% are tested.

Allowed values are 101-500.

`[\FricLevelMin]`

Friction level min

Data type: `num`

Normally, the optimal friction value is found by trying values between 1% and 500% of the configured friction value. To set a higher starting value than 1% use the argument `FricLevelMin`. For example, if `FricLevelMin` is set to 80, values between 80% and 500% are tested.

Allowed values are 1-99.

`[\OptTolerance]`

Optimization tolerance

Data type: `num`

Normally, the optimal friction value is found by trying values until a small tolerance is achieved. To speed up the process this value can be increased. Increasing this value might give a less accurate result.

Allowed values are 1-10. Default value is 1.

Error handling

The following recoverable errors can be generated. The errors can be handled in an ERROR handler. The system variable `ERRNO` will be set to:

Name	Cause of error
<code>ERR_FRICTUNE_FATAL</code>	An error occurs during the friction tuning.

Continues on next page

1 Instructions

1.85 FricIdEvaluate - Evaluate friction identification

Advanced Shape Tuning

Continued



Note

If the friction tuning has no effect at all, check that the system parameter *Friction FFW On* is set to TRUE.

Prerequisites

The system parameter *Friction FFW On* must be set to TRUE. Otherwise the instruction `FricIdEvaluate` will do nothing.

Limitations

- `FricIdEvaluate` only works for TCP robots.
- `FricIdEvaluate` can only be executed from motion tasks.
- The robot must move on the basic path level.
- For a MultiMove system, friction tuning can only be done for one robot at a time. Several robots can execute `FricIdEvaluate` simultaneously, but they will automatically stand still and wait for their turn as long as another robot is busy doing friction tuning.
- Friction tuning cannot be combined with synchronized movement. That is, `SyncMoveOn` is not allowed between `FricIdInit` and `FricIdEvaluate`.
- The movement sequence for which friction tuning is done must begin and end with a finepoint. If not, finepoints will automatically be inserted during the tuning process.

Syntax

```
FricIdEvaluate
[ FricLevels ':='] < persistent array {*} (PERS) of num >
[ '\ ' MechUnit ':='] < variable (VAR) of mecunit >]
[ '\ ' BwdSpeed ':='] < expression (IN) of speeddata >]
[ '\ ' NoPrint]
[ '\ ' FricLevelMax ':='] < expression (VAR) of num >]
[ '\ ' FricLevelMin ':='] < expression (VAR) of num >]
[ '\ ' OptTolerance ':='] < expression (VAR) of num >] ';'

```

Related information

For information about	See
<i>Advanced robot motion</i>	<i>Application manual - Controller software IRC5</i>

1.86 FricIdSetFricLevels - Set friction levels after friction identification

Advanced Shape Tuning

1.86 FricIdSetFricLevels - Set friction levels after friction identification

Usage

`FricIdSetFricLevels` is used for setting the friction level for each axis of a mechanical unit.

Example

Basic example where a circle movement is used to calculate the robot's internal friction for this movement.

```
PERS num friction_levels{6};

! Start of the friction calculation sequence
FricIdInit;

! Execute the move sequence
MoveC p10, p20, Speed, z0, Tool;
MoveC p30, p40, Speed, z0, Tool;

! Repeat the sequence and calculate the friction
FricIdEvaluate friction_levels;

! Activate compensation for the calculated friction levels
FricIdSetFricLevels friction_levels;
```

Arguments

```
FricIdSetFricLevels FricLevels [\MechUnit]
```

`FricLevels`

Friction levels

Data type: array of num

The array `FricLevels` specifies the friction level for each axis in percent of the default friction. The values must be in the interval 0-500.

`[\MechUnit]`

Mechanical unit

Data type: mecunit

The argument `MechUnit` is optional. If it is omitted, the friction levels will be set for the mechanical unit represented by the predefined RAPID variable `ROB_ID`. Friction compensation is only possible for TCP robots.

Program execution

The settings of the friction levels will remain active until:

- Program execution is started from the beginning (PP to Main)
- Another call to `FricIdSetFricLevels` is made
- A new program is loaded
- The controller is restarted using the restart mode **Reset system**.

Continues on next page

1 Instructions

1.86 FricIdSetFricLevels - Set friction levels after friction identification

Advanced Shape Tuning

Continued

Prerequisites

The system parameter *Friction FFW On* must be set to TRUE. Otherwise the instruction `FricIdSetFricLevels` will do nothing.

Limitations

- `FricIdSetFricLevels` only works for TCP robots.
-

Syntax

```
FricIdSetFricLevels
  [ FricLevels '[:=' < array {*} (IN) of num >
  ['\' MechUnit '[:=' < variable (VAR) of mecunit >] ';' ]
```

Related information

For information about	See
<i>Advanced robot motion</i>	<i>Application manual - Controller software IRC5</i>

1.87 GetDataVal - Get the value of a data object

Usage

GetDataVal (*Get Data Value*) makes it possible to get a value from a data object that is specified with a string variable.

Basic examples

The following examples illustrate the instruction GetDataVal:

Example 1

```
VAR datapos block;
VAR string name;
VAR num valuevar;
...
SetDataSearch "num" \Object:="my.*" \InMod:="mymod";
WHILE GetNextSym(name,block) DO
  GetDataVal name\Block:=block,valuevar;
  TPWrite name+" "\Num:=valuevar;
ENDWHILE
```

This session will print out all num variables that begin with my in the module mymod with its value to the FlexPendant.

Example 2

```
VAR num NumArrConst_copy{2};
...
GetDataVal "NumArrConst", NumArrConst_copy;
TPWrite "Pos1 = " \Num:=NumArrConst_copy{1};
TPWrite "Pos2 = " \Num:=NumArrConst_copy{2};
```

This session will print out the num variables in the array NumArrConst.

Arguments

```
GetDataVal Object [\Block][\TaskRef][\TaskName] Value
```

Object

Data type: string

The name of the data object.

[\Block]

Data type: datapos

The enclosed block to the data object. This can only be fetched with the GetNextSym function.

If this argument is omitted, the value of the visible data object in the current program execution scope will be fetched.

[\TaskRef]

Task Reference

Data type: taskid

Continues on next page

1 Instructions

1.87 GetDataVal - Get the value of a data object

RobotWare Base

Continued

The program task identity in which to search for the data object specified. When using this argument, you may search for `PERS` or `TASKPERS` declarations in other tasks, any other declarations will result in an error.

For all program tasks in the system the predefined variables of the data type `taskId` will be available. The variable identity will be "taskname"+"Id", for example, for the `T_ROB1` task the variable identity will be `T_ROB1Id`.

[\TaskName]

Data type: `string`

The program task name in which to search for the data object specified. When using this argument, you may search for `PERS` or `TASKPERS` declarations in other tasks, any other declarations will result in an error.

Value

Data type: `anytype`

Variable for storage of the get value. The data type must be the same as the data type for the data object to find. The get value can be fetched from a constant, variable, or persistent but must be stored in a variable.

Error handling

The following recoverable errors can be generated. The errors can be handled in an ERROR handler. The system variable `ERRNO` will be set to:

Name	Cause of error
<code>ERR_SYM_ACCESS</code>	<ul style="list-style-type: none">The data object is non-existent.The data object is routine data or routine parameter and is not located in the current active routine.Searching in other tasks for other declarations than <code>PERS</code> or <code>TASK PERS</code>.
<code>ERR_INVDIM</code>	The data object and the variable used in argument <code>Value</code> have different dimensions.
<code>ERR_SYMBOL_TYPE</code>	The data object and the variable used in argument <code>Value</code> is of different types. If using <code>ALIAS</code> datatypes, you will also get this ERROR, even though the types might have the same base data type.
<code>ERR_TASKNAME</code>	If the program task name in argument <code>\TaskName</code> cannot be found in the system, the system variable <code>ERRNO</code> is set to <code>ERR_TASKNAME</code> .

When using the arguments `TaskRef` or `TaskName` you may search for `PERS` or `TASK PERS` declarations in other tasks, any other declarations will result in an error and the system variable `ERRNO` is set to `ERR_SYM_ACCESS`. Searching for a `PERS` declared as `LOCAL` in other tasks will also result in an error and the system variable `ERRNO` is set to `ERR_SYM_ACCESS`.

Limitations

For a semivalue data type, it is not possible to search for the associated value data type. For example, if searching for `dionum`, no search hit for signals `signaldi` will be obtained and if searching for `num`, no search hit for signals `signalgi` or `signalai` will be obtained.

Continues on next page

It is not possible to get the value of a variable declared as LOCAL in a built in RAPID module.

Syntax

```
GetDataVal
[ Object ':= ' ] < expression (IN) of string >
[ '\Block' := '<variable (VAR) of datapos>' ]
|[ '\TaskRef' := '<variable (VAR) of taskid>' ]
|[ '\TaskName' := '<expression (IN) of string>' ,']
[ Value ':= ' ] <variable (VAR) of anytype>';'
```

Related information

For information about	See
Define a symbol set in a search session	SetDataSearch - Define the symbol set in a search sequence on page 696
Get next matching symbol	GetNextSym - Get next matching symbol on page 1299
Set the value of a data object	SetDataVal - Set the value of a data object on page 701
Set the value of many data objects	SetAllDataVal - Set a value to all data objects in a defined set on page 692
The related data type datapos	datapos - Enclosing block for a data object on page 1646
<i>Advanced RAPID</i>	<i>Application manual - Controller software IRC5</i>

1 Instructions

1.88 GetGroupSignalInfo - Read information about a digital group signal

RobotWare Base

1.88 GetGroupSignalInfo - Read information about a digital group signal

Usage

`GetGroupSignalInfo` is used to read out information about a digital group signal from I/O.

Basic examples

The following example illustrates the instruction `GetGroupSignalInfo`.

Example 1

```
VAR dnum DValue;  
VAR string label;  
VAR string devicename;  
  
GetGroupSignalInfo go1 \MaxDValue:=DValue \Label:=label  
  \DeviceName:=devicename;
```

Read out maximum signal value that can be set to the signal go1, the signal identification label and the device name the signal is assigned to.

Arguments

```
GetGroupSignalInfo Signal [\MaxDValue] [\Label] [\DeviceName]
```

Signal

Data type: `signalxx`

The signal identifier according to the program (data type `signalgo` or `signalgi`) to get information about.

\MaxDValue

Data type: `dnum`

The `MaxDValue` is the maximum value that can be set to the signal. It is based on the device mapping of the signal.

\Label

Data type: `string`

The `Label` is the signal identification label specified.

\DeviceName

Data type: `string`

The `DeviceName` is the device the signal is assigned to.

Program execution

The instruction reads out information about a digital group signal from I/O.

Continues on next page

1.88 GetGroupSignalInfo - Read information about a digital group signal

RobotWare Base

Continued

Error handling

The following recoverable errors are generated and can be handled in an error handler. The system variable `ERRNO` will be set to:

Name	Cause of error
ERR_NO_ALIASIO_DEF	The signal variable is a variable declared in RAPID. It has not been connected to an I/O signal defined in the I/O configuration with instruction AliasIO.

Syntax

```
GetGroupSignalInfo
  [ Signal ':=' ] < variable (VAR) of anytype >
  [ '\ ' MaxDvalue ':=' < variable (VAR) of dnum >]
  [ '\ ' Label ':=' < variable (VAR) of string >]
  [ '\ ' DeviceName ':=' < variable (VAR) of string >] ';'

```

Related information

For information about	See
Read attribute of a system parameter	ReadCfgData - Reads attribute of a system parameter on page 586
Configuration of I/O	<i>Technical reference manual - System parameters</i>

1 Instructions

1.89 GetJointData - Get joint specific data

RobotWare Base

1.89 GetJointData - Get joint specific data

Usage

`GetJointData` is used to read out joint specific data from a specified mechanical unit. The information that can be read for the specified axis is the position, speed, torque, and estimated external torque.

Basic examples

The following example illustrates the instruction `GetJointData`.

Example 1

```
VAR num position;  
VAR num speed;  
VAR num torque;  
VAR num exttorque;  
...  
GetJointData \MechUnit:=ROB_1, 1 \Position:=position \Speed:=speed  
            \Torque:=torque \ExtTorque:=exttorque;
```

The current position, speed, torque, and estimated external torque of the first axis of `ROB_1` is read.

Arguments

```
GetJointData [\MechUnit] Axis [\Position] [\Speed] [\Torque]  
            [\ExtTorque]
```

`[\MechUnit]`

Mechanical Unit

Data type: `mecunit`

The name of the mechanical unit for which an axis is to be read. If this argument is omitted, the axis for the connected robot is read.

`Axis`

Data type: `num`

The number of the axis to be read (1 - 6).

`[\Position]`

Data type: `num`

The current position of the stated axis of the robot or external axis on the arm side. The value is in degrees for a rotating axis and mm for a linear axis.

At least one of the optional parameters `\Position`, `\Speed`, `\Torque`, or `\ExtTorque` must be used.

`[\Speed]`

Data type: `num`

The current speed of the stated axis of the robot or external axis on the arm side. The value is in degrees/second for a rotating axis and mm/second for a linear axis.

At least one of the optional parameters `\Position`, `\Speed`, `\Torque`, or `\ExtTorque` must be used.

Continues on next page

[\Torque]

Data type: num

The current torque in Nm of the of the stated axis of the robot or external axis on the arm side.

At least one of the optional parameters \Position, \Speed, \Torque, or \ExtTorque **must be used.**

[\ExtTorque]

Data type: num

The current estimated external torque in Nm of the of the stated axis of the robot or external axis on the arm side.

At least one of the optional parameters \Position, \Speed, \Torque, or \ExtTorque **must be used.**

Program execution

The instruction reads position, speed, torque, and estimated external torque of the robot and external axes.

The read values can also be seen when using *TuneMaster* using test signal numbers 4000, 4001, 4002, and 4003.

Error handling

The following recoverable errors are generated and can be handled in an error handler. The system variable `ERRNO` will be set to:

ERR_AXIS_PAR	Parameter axis in instruction is wrong.
ERR_AXIS_ACT	The axis is not activated.

Syntax

```
GetJointData
  ['\ MechUnit :=' < variable (VAR) of mecunit> ',']
  [Axis :=' ] < expression (IN) of num>
  [ '\ Position :=' < variable (VAR) of num> ]
  [ '\ Speed :=' < variable (VAR) of num> ]
  [ '\ Torque :=' < variable (VAR) of num> ]
  [ '\ ExtTorque :=' < variable (VAR) of num> ] ';'

```

1 Instructions

1.90 GetSysData - Get system data

RobotWare Base

1.90 GetSysData - Get system data

Usage

`GetSysData` fetches the value and the optional symbol name for the current system data of specified data type.

With this instruction it is possible to fetch data and the name of the current active Tool, Work Object, PayLoad or Total Load for the robot in actual or connected motion task, or any named motion task.

Basic examples

The following examples illustrate the instruction `GetSysData`:

Example 1

```
PERS tooldata curtoolvalue := [TRUE, [[0, 0, 0], [1, 0, 0, 0]],  
    [2, [0, 0, 2], [1, 0, 0, 0], 0, 0, 0]];  
VAR string curtoolname;  
GetSysData curtoolvalue;
```

Copy current active tool data value to the persistent variable `curtoolvalue`.

Example 2

```
GetSysData curtoolvalue \ObjectName := curtoolname;
```

Also copy current active tool name to the variable `curtoolname`.

Example 3

```
PERS loaddata curload;  
PERS loaddata piece:=[2.8,[-38.2,-10.1,-73.6],[1,0,0,0],0,0,0];  
PERS loaddata  
    tool2piece:=[13.1,[104.5,13.5,115.9],[1,0,0,0],0,0,0.143];  
PERS tooldata tool2 := [TRUE, [[138.695,150.023,98.9783],  
    [0.709396,-0.704707,-0.00856676,0.00851007]],  
    [10,[105.2,-3.8,118.7], [1,0,0,0],0,0,0.123]];  
VAR string name;  
..  
IF GetModalPayloadMode() = 1 THEN  
    GripLoad piece;  
    MoveL p3, v1000, fine, tool2;  
    ..  
    ..  
    ! Get current payload  
    GetSysData curload \ObjectName := name;  
ELSE  
    MoveL p30, v1000, fine, tool2\TLoad:=tool2piece;  
    ..  
    ..  
    ! Get current total load  
    GetSysData curload \ObjectName := name;  
ENDIF
```

If `ModalPayloadMode` is 1, copy current active payload and name to the variable `name`.

If `ModalPayloadMode` is 0, copy current total load and name to the variable `name`.

Continues on next page

Arguments

GetSysData [\TaskRef] [\TaskName] DestObject [\ObjectName]

[\TaskRef]

Task Reference

Data type: taskid

The program task identity from which the data of the current active system data should be read.

For all program tasks in the system, predefined variables of the data type `taskid` will be available. The variable identity will be "taskname"+"Id", e.g. for the `T_ROB1` task the variable identity will be `T_ROB1Id`.

[\TaskName]

Data type: string

The program task name from which the current active system data should be read.

If none of the arguments `\TaskRef` or `\TaskName` are specified then the current task is used.

DestObject

Data type: anytype

Persistent variable for storage of current active system data value.

The data type of this argument also specifies the type of system data (Tool, Work Object, or Payload/Total Load) to fetch. If using `TLoad` optional argument on movement instructions, the Total Load is fetched instead of the `Payload`, if a `loaddata` datatype is used.

Data type	Type of system data
tooldata	Tool
wobjdata	Work Object
loaddata	Payload/Total Load

Array or record component cannot be used.

[\ObjectName]

Data type: string

Optional argument (variable or persistent) to also fetch the current active system data name.

Program execution

When running the instruction `GetSysData` the current data value is stored in the specified persistent variable in argument `DestObject`.

If argument `\ObjectName` is used, the name of the current data is stored in the specified variable or persistent in argument `ObjectName`.

Current system data for Tool, Work Object or Total load is activated by execution of any move instruction. Payload is activated by execution of the instruction `GripLoad`.

Continues on next page

1 Instructions

1.90 GetSysData - Get system data

RobotWare Base

Continued

Error handling

The following recoverable errors can be generated. The errors can be handled in an ERROR handler. The system variable `ERRNO` will be set to:

Name	Cause of error
<code>ERR_NOT_MOVETASK</code>	<p>The arguments <code>\TaskRef</code> or <code>\TaskName</code> specifies a non-motion task.</p> <p> Note</p> <p>No error will be generated if the arguments <code>\TaskRef</code> or <code>\TaskName</code> specify the non-motion task that executes this function <code>GetSysData</code> (reference to my own non-motion task). The current system data will then be fetched from the connected motion task.</p>
<code>ERR_TASKNAME</code>	<p>If the program task name in argument <code>\TaskName</code> cannot be found in the system, the system variable <code>ERRNO</code> is set to <code>ERR_TASKNAME</code>.</p>

Syntax

```
GetSysData
  ['\' TaskRef' :=' <variable (VAR) of taskid>]
  [['\' TaskName' :=' <expression (IN) of string>]
  [ DestObject' :='] <persistent(PERS) of anytype>
  [\'ObjectName' :=' <variable or persistent (INOUT) of string>]';'
```

Related information

For information about	See
Definition of tools	tooldata - Tool data on page 1776
Definition of work objects	wobjdata - Work object data on page 1803
Definition of payload	loaddata - Load data on page 1682
Set system data	SetSysData - Set system data on page 713
System parameter <code>ModalPayloadMode</code> for activating and deactivating payload.	<i>Technical reference manual - System parameters</i>
Example of how to use <code>TLoad</code> , Total Load.	MoveL - Moves the robot linearly on page 458

1.91 GetTrapData - Get interrupt data for current trap routine

Usage

GetTrapData is used in a trap routine to obtain all information about the interrupt that caused the trap routine to be executed.

To be used in trap routines generated by instruction IError, before use of the instruction ReadErrData.

Basic examples

The following example illustrates the instruction GetTrapData:

See also [More examples on page 239](#).

Example 1

```
VAR trapdata err_data;
GetTrapData err_data;
```

Store interrupt information in the non-value variable err_data.

Arguments

GetTrapData TrapEvent

TrapEvent

Data type: trapdata

Variable for storage of the information about what caused the trap to be executed.

More examples

More examples of the instruction GetTrapData are illustrated below.

Example 1

```
VAR errdomain err_domain;
VAR num err_number;
VAR errtype err_type;
VAR trapdata err_data;
...
TRAP trap_err
  GetTrapData err_data;
  ReadErrData err_data, err_domain, err_number, err_type;
ENDTRAP
```

When an error is trapped to the trap routine trap_err, the error domain, the error number, and the error type are saved into appropriate non-value variables of the type trapdata.

Limitation

This instruction can only be used in a trap routine.

Syntax

```
GetTrapData
  [TrapEvent ':=' ] <variable (VAR) of trapdata>;'
```

Continues on next page

1 Instructions

1.91 GetTrapData - Get interrupt data for current trap routine

RobotWare Base

Continued

Related information

For information about	See
Summary of interrupts	<i>Technical reference manual - RAPID Overview</i>
More information on interrupt management	<i>Technical reference manual - RAPID Overview</i>
Interrupt data for the current trap	trapdata - Interrupt data for current trap routine on page 1783
Orders an interrupt on errors	IError - Orders an interrupt on errors on page 255
Gets information about an error	ReadErrData - Gets information about an error on page 590
<i>Advanced RAPID</i>	<i>Application manual - Controller software IRC5</i>

1.92 GOTO - Goes to a new instruction

Usage

GOTO is used to transfer program execution to another line (a label) within the same routine.

Basic examples

The following example illustrates the instruction **GOTO**:

Example 1

```
GOTO next;  
...  
next:
```

Program execution continues with the instruction following **next**.

Example 2

```
reg1 := 1;  
next:  
...  
reg1 := reg1 + 1;  
IF reg1<=5 GOTO next;
```

The execution will be transferred to **next** four times (for **reg1**= 2, 3, 4, 5).

Example 3

```
IF reg1>100 THEN  
  GOTO highvalue  
ELSE  
  GOTO lowvalue  
ENDIF  
lowvalue:  
...  
GOTO ready;  
highvalue:  
...  
ready:
```

If **reg1** is greater than 100, the execution will be transferred to the label **highvalue**, otherwise the execution will be transferred to the label **lowvalue**.

Arguments

GOTO Label

Label

Identifier

The label from where program execution is to continue.

Limitations

It is only possible to transfer program execution to a label within the same routine.

Continues on next page

1 Instructions

1.92 GOTO - Goes to a new instruction

RobotWare Base

Continued

It is only possible to transfer program execution to a label within an `IF` or `TEST` instruction if the `GOTO` instruction is also located within the same branch of that instruction.

It is only possible to transfer program execution to a label within a `FOR` or `WHILE` instruction if the `GOTO` instruction is also located within that instruction.

Syntax

```
GOTO <identifier>' ;'
```

Related information

For information about	See
Label	Label - Line name on page 341
Other instructions that change the program flow	<i>Technical reference manual - RAPID Overview</i>

1.93 GripLoad - Defines the payload for a robot

Usage

`GripLoad` is used to define the payload which the robot holds in its gripper.

Description

`GripLoad` specifies which load the robot is carrying. Specified load is used by the control system so that the robot movements can be controlled in the best possible way.

The payload is connected/disconnected using the instruction `GripLoad`, which adds or subtracts the weight of the payload to the weight of the gripper.



WARNING

It is important to always define the actual tool load and, when used, the payload of the robot (for example, a gripped part). Incorrect definitions of load data can result in overloading of the robot mechanical structure. There is also a risk that the speed in manual reduced speed mode can be exceeded.

When incorrect load data is specified, it can often lead to the following consequences:

- The robot may not use its maximum capacity.
- Impaired path accuracy including a risk of overshooting.
- Risk of overloading the mechanical structure.

The controller continuously monitors the load and writes an event log if the load is higher than expected. This event log is saved and logged in the controller memory.

Basic examples

The following examples illustrate the instruction `GripLoad`.

Example 1

```
Set doGripper;  
!wait to grip  
WaitTime 0.3;  
GripLoad piece1;
```

Connection of the payload, `piece1`, specified at the same time as the robot grips the load.

Example 2

```
Reset doGripper;  
!wait to release  
WaitTime 0.3;  
GripLoad load0;
```

Disconnection of a payload, specified at the same time as the robot releases a payload.

Continues on next page

1 Instructions

1.93 GripLoad - Defines the payload for a robot

RobotWare Base

Continued

Arguments

GripLoad Load

Load

Data type: loaddata

The load data that describes the current payload.

It is possible to test run the program without any payload by using a digital input signal connected to the system input `SimMode` (Simulated Mode). If the digital input signal is set to 1, the `loaddata` in the `GripLoad` instruction is not considered, and only the `loaddata` in the current `tooldata` is used.

Program execution

The specified load applies for the next executed movement instruction until a new `GripLoad` instruction is executed.

The specified load affects the performance of the robot.

The default load (`load0`), 0 kg, is automatically set

- when using the restart mode **Reset RAPID**
- when loading a new program or a new module
- when starting program execution from the beginning
- when moving the program pointer to `main`
- when moving the program pointer to a routine
- when moving the program pointer in such a way that the execution order is lost.

The payload is updated for the mechanical unit that is controlled from current program task. If `GripLoad` is used from a non-motion task, the payload is updated for the mechanical unit controlled by the connected motion task.

Syntax

```
GripLoad  
  [Load ':='] <persistent (PERS) of loaddata>';'
```

Related information

For information about	See
Load identification of tool load, payload or arm load	<i>Operating manual - IRC5 with FlexPendant</i> , section <i>Programming and testing - Service routines</i>
Define payload for mechanical units	MechUnitLoad - Defines a payload for a mechanical unit on page 385
Definition of load data	loaddata - Load data on page 1682
System input signal <code>SimMode</code> for running the robot in simulated mode without payload.	<i>Technical reference manual - System parameters</i>

1.94 HollowWristReset - Reset hollow wrist

Usage

`HollowWristReset` (*Reset hollow wrist*) resets the position of the wrist joints on hollow wrist manipulators, such as IRB 5402 and IRB 5403.

The instruction makes it possible to avoid rewinding the wrist joints 4 and 5 after they have been wound up one or more revolutions. After executing a `HollowWristReset` instruction, the wrist joints may continue to wind up in the same direction.

Description

`HollowWristReset` makes it easier to make application programs. You do not have to ensure that the wrist position is within ± 2 revolutions at the time of programming, and it may save cycle time because the robot does not have to spend time rewinding the wrist. There is a limitation of ± 144 revolutions for winding up joints 4 and 5 before the wrist position is reset by `HollowWristReset`. The robot programmer must be aware of this limitation and take it into consideration when planning the robot programs. To ensure that the 144 revolution limit is not exceeded after running a *wrist-winding* program several times, you should always let the robot come to a complete stop and reset the absolute position in every program (or cycle/routine/module and so on as necessary). Note that all axes must remain stopped during the execution of the `HollowWristReset` instruction. As long as these limitations are taken into consideration, joints 4 and 5 can wind indefinitely and independently of joint 6 during program execution.

Use `HollowWristReset` instead of `IndReset` to reset the hollow wrist as this instruction preserves the joint limits for joint 6 to prevent too much twisting of the paint tubes/cables.

Basic examples

The following example illustrates the instruction `HollowWristReset`:

Example 1

```
MoveL p10,v800,fine,paintgun1\WObj:=workobject1;  
HollowWristReset;
```

All active axes are stopped by a stop point and the wrist is reset.

Limitations

All active axes must be stopped while the `HollowWristReset` instruction is executed.

The wrist joints must be reset before any of them reach the ± 144 revolution limit (51840degrees/904rad).

Whenever a program stop, emergency stop, power failure stop, and so on occurs, the controller retains the path context to be able to return to the path and let the robot continue program execution from the point on the path at which it was stopped. In manual mode, if the manipulator has been moved out of the path between a stop and a restart, the operator is informed by the following message

Continues on next page

1 Instructions

1.94 HollowWristReset - Reset hollow wrist

RobotWare Base

Continued

on the FlexPendant: **Not on path! Robot has been moved after program stop. Should the robot return to the path on Start? Yes/No/Cancel.** This provides an opportunity of returning to the path before restart. In automatic mode, the robot automatically returns to the path.

HollowWristReset removes the path context. This means that it is not possible to return to the path in case of a program restart if the HollowWristReset instruction has been executed in the meantime. If this instruction is executed manually (service routine) it should only be executed at a time when returning to the path is not required. That is, after a program is completely finished, or an instruction is completely finished in step-by-step execution and the manipulator is not moved out of the path by jogging, and so on.

Syntax

```
HollowWristReset ';' 
```

Related information

For information about	See
Related system parameters	<i>Technical reference manual - System parameters</i>
Return to path	<i>Technical reference manual - RAPID Overview</i>

1.95 ICap - connect CAP events to trap routines

Usage

ICap is used to connect an interrupt number (which is already connected to a trap routine) with a specific CAP Event, see Arguments below for a listing of available Events. When using ICap, an association between a specific process event and a user defined Trap routine is created. In other words, the Trap routine in question is executed when the associated CAP event occurs.

We recommend placing the traps in a background task.

Basic example

Below is an example where the CAP Event CAP_START is associated with the trap routine start_trap.

```
VAR intnum start_intno:=0;
...

TRAP start_trap
  ! This routine will be executed when the event CAP_START is
  reported from the core
  ! Do what you want to do
ENDTRAP

PROC main()
  IDelete start_intno;
  CONNECT start_intno WITH start_trap;
  ICap start_intno, CAP_START;
  CapL p1, v100, cdata, weavestart, weave, z50, gun1;
ENDPROC
```

Arguments

ICap Interrupt Event

Interrupt

Data type: intnum

The interrupt identity. This should have previously been connected to a trap routine by means of the instruction CONNECT.

Event

Data type: num

The CAP event number to be associated with the interrupt. These events are predefined constants.

Continues on next page

1 Instructions

1.95 ICap - connect CAP events to trap routines

Continuous Application Platform (CAP)

Continued

Available CAP events

To see the events listed according to phases, see section *Coupling between phases and events* in *Application manual - Continuous Application Platform*.

Events	Phase	Event number	Description
AT_ERRORPOINT	MAIN	28	This event occurs after restart, when the TCP reaches the position of the supervision error.
AT_POINT	MAIN	13	This event occurs at every robtarget on the process path except the start and finish point.
AT_RESTARTPOINT	MAIN	14	This event occurs when the robot has jogged back, the restart distance, on the process path after a stop.
CAP_PF_RESTART	MAIN	26	This event occurs when restart is ordered.
CAP_START		0	This event occurs as soon as the CAP process is started.
CAP_STOP		25	This event is a required event. If any other event is used, this event must be defined too. The event/trap is executed as soon as possible after the controller is stopped due to an error or a program stop. An error can be a recoverable error detected in CAP, a fatal error detected in CAP or an internal error stopping the controller. The code executed in this trap should take all external equipment to a safe state, for example, reset all external I/O-signals. Keep in mind that TRAP execution is stopped when RAPID execution of a NORMAL task is stopped. Therefore the TRAP connected to CAP_STOP has to be placed in a STATIC or SEMISTATIC task.
END_MAIN	END_MAIN	17	This event occurs at the point on the process path where supervision of the end sequence is started, that is, when the robot reaches the end point of the process.
END_POST1	END_POST1	21	This event occurs when it is time to end the POST1 phase, that is, when it is time to change from the POST1 to the POST2-phase. If using a <i>flying end</i> no event is distributed.
END_POST2	END_POST2	23	This event occurs when the POST2 phase is at an end, that is, when it is time to finally finish the process. If using a <i>flying end</i> no event is distributed.
END_PRE	PRE	32	This event occurs when the supervision of the PRE-phase, if present, is activated. If using a <i>flying start</i> no event is distributed, because there is a TCP movement already. At a restart this event is distributed.
EQUIDIST	MAIN	27	This event is sent, if it is ordered with the instruction <code>CapEquiDist</code> .

Continues on next page

1.95 ICap - connect CAP events to trap routines Continuous Application Platform (CAP)

Continued

Events	Phase	Event number	Description
FLY_END	MAIN	30	This event occurs when using <i>flying end</i> . This event is only available with <i>flying end</i> .
FLY_START	MAIN	29	This event occurs when using <i>flying start</i> . This event is only available with <i>flying start</i> .
LAST_INSTR_ENDED	MAIN	31	This event occurs when RAPID execution of the last CAP instruction is finished during <i>flying end</i> . This event is only available with <i>flying end</i> .
LAST_SEGMENT	MAIN	15	This event occurs at the starting point of the last segment.
MAIN_ENDED	END_MAIN	18	This event occurs when all conditions of the END_MAIN supervision list are fulfilled, that is, when the main process is considered ended.
MAIN_MOTION	MAIN	9	This event occurs when main motion is activated with the process running.
MAIN_STARTED	START	4	This event occurs when all conditions of the START Supervision list are fulfilled, that is, when the MAIN-phase is started.
MOTION_DELAY	MAIN	7	This event occurs after the delay, if any, of motion start. If using a <i>flying start</i> no event is distributed, because there is a TCP movement already. At a restart this event is distributed.
MOVE_STARTED	MAIN	10	This event occurs as soon as the robot starts moving along the process path. If using a <i>flying start</i> no event is distributed, because there is a TCP movement already. At a restart this event is distributed.
NEW_INSTR	MAIN	12	This event occurs when a new CapL or CapC instruction is fetched from the RAPID program.
PATH_END_POINT		19	This event occurs when the robot reaches the end point of the path, that is, the fine point or the middle of the zone (for <i>flying end</i>) in the last CAP instruction.
POST1_ENDED	END_POST1	22	This event occurs when all the conditions of the END_POST1 supervision list are fulfilled, that is, when the POST1 phase is successfully ended and the POST2 phase is started. If using a <i>flying end</i> no event is distributed.
POST1_STARTED	POST1	35	This event occurs when the supervision of the POST1-phase, if present, is activated. If using a <i>flying start</i> no event is distributed, because there is a TCP movement already. At a restart this event is distributed.

Continues on next page

1 Instructions

1.95 ICap - connect CAP events to trap routines

Continuous Application Platform (CAP)

Continued

Events	Phase	Event number	Description
POST2_ENDED	END_POST2	24	This event occurs when all the conditions of the END_POST2 supervision list are fulfilled, that is, when the POST2 phase, and thus the whole process, is successfully ended. If using a <i>flying end</i> no event is distributed.
POST2_STARTED	POST2	37	This event occurs when the supervision of the POST1-phase, if present, is activated. If using a <i>flying start</i> no event is distributed, because there is a TCP movement already. At a restart this event is distributed.
PRE_ENDED	PRE	33	This event occurs when the supervision of the PRE-phase, if present, is activated. If using a <i>flying start</i> no event is distributed, because there is a TCP movement already. At a restart this event is distributed.
PRE_STARTED	PRE	2	This event occurs when all the requirements of the PRE Supervision list are fulfilled, that is, when the PRE_START-phase is started. If using a <i>flying start</i> no event is distributed, because there is a TCP movement already. At a restart this event is distributed.
PROCESS_END_POINT	MAIN	16	This event occurs when the robot reaches the end point of the process, that is, where the process is supposed to be ended. If using a <i>flying end</i> no event is distributed.
PROCESS_ENDED		20	This event occurs only when both the process is ended at the fine point or the middle of the zone (for <i>flying end</i>) in the last CAP instruction.
RESTART	MAIN	11	This event occurs when restart is ordered.
START_MAIN	START	3	This event occurs when the PRE_START-phase is ended and the MAIN-phase is started.
START_POST1	POST1	34	This event occurs when the supervision of the POST1-phase, if present, is activated. If using a <i>flying start</i> no event is distributed, because there is a TCP movement already. At a restart this event is distributed.
START_POST2	POST2	36	This event occurs when the supervision of the POST1-phase, if present, is activated. If using a <i>flying start</i> no event is distributed, because there is a TCP movement already. At a restart this event is distributed.
START_PRE	PRE	1	This event occurs when the supervision of the PRE-phase, if present, is activated. If using a <i>flying start</i> no event is distributed, because there is a TCP movement already. At a restart this event is distributed.

Continues on next page

Events	Phase	Event number	Description
STARTSPEED_TIME	MAIN	8	This event occurs when the time to use <i>Start Speed</i> runs out and it is time to switch to main motion data.
STOP_WEAVESTART	MAIN	5	This event occurs, before each weave start - but only if weave start is ordered. If using a <i>flying start</i> no event is distributed, because there is a TCP movement already. At a restart this event is distributed.
WEAVESTART_REGAIN	MAIN	6	This event occurs when the robot has regained back to the path after a weave start. If using a <i>flying start</i> no event is distributed, because there is a TCP movement already. At a restart this event is distributed.

Limitations

The same variable for interrupt identity cannot be used more than once, without first deleting it. Interrupts should therefore be handled as shown in one of the alternatives below.

```
PROC setup_events ()
  VAR intnum start_intno;
  IDelete start_intno;
  CONNECT start_intno WITH start_trap;
  ICap start_intno, CAP_START;
ENDPROC
```

All activation of interrupts is done at the beginning of the program. These instructions are then kept outside the main flow of the program. The ICap instruction should be executed only once, for example, from the startup system event routine. A recommendation is that the traps should be placed in a background task.

Syntax

```
ICap
  [Interrupt ':='] < variable (IN) of intnum > ','
  [Event ':='] < variable (IN) of num > ';'

```

Related information

For information about	See
<i>Continuous Application Platform</i>	<i>Application manual - Continuous Application Platform</i>
Connect an interrupt with a trap	CONNECT - Connects an interrupt to a trap routine on page 160
Cancel an interrupt connected to a trap	IDelete - Cancels an interrupt on page 252
Data type intnum	intnum - Interrupt identity on page 1675

1 Instructions

1.96 IDelete - Cancels an interrupt
RobotWare Base

1.96 IDelete - Cancels an interrupt

Usage

IDelete (*Interrupt Delete*) is used to cancel (delete) an interrupt subscription. If the interrupt is to be only temporarily disabled, the instruction ISleep or IDisable should be used.

Basic examples

The following example illustrates the instruction IDelete:

Example 1

```
IDelete feeder_low;
```

The interrupt `feeder_low` is cancelled.

Arguments

```
IDelete Interrupt
```

Interrupt

Data type: `intnum`

The interrupt identity.

Program execution

The definition of the interrupt is completely erased. To define it again it must first be re-connected to the trap routine.

It is recommended to precede IDelete with a stop point. Otherwise the interrupt will be deactivated before the end point of the movement path is reached.

Interrupts do not have to be erased; this is done automatically when

- a new program is loaded
 - the program is restarted from the beginning
 - the program pointer is moved to the start of a routine
-

Syntax

```
IDelete [ Interrupt ':' ] < variable (VAR) of intnum > ';' ;
```

Related information

For information about	See
Summary of interrupts	<i>Technical reference manual - RAPID Overview</i>
More information about interrupt management	<i>Technical reference manual - RAPID Overview</i>
Temporarily disabling an interrupt	ISleep - Deactivates an interrupt on page 331
Temporarily disabling all interrupts	IDisable - Disables interrupts on page 253

1.97 IDisable - Disables interrupts

Usage

`IDisable`(*Interrupt Disable*) is used to disable all interrupts temporarily. It may, for example, be used in a particularly sensitive part of the program where no interrupts may be permitted to take place if they disturb normal program execution.

Basic examples

The following example illustrates the instruction `IDisable`:

Example 1

```
IDisable;
FOR i FROM 1 TO 100 DO
  character[i]:=ReadBin(sensor);
ENDFOR
IEnable;
```

No interrupts are permitted while reading from the sensor. When it has finished reading, interrupts are once more permitted.

Program execution

Interrupts that occur during the time in which an `IDisable` instruction is in effect are placed in a queue. When interrupts are permitted once more, then the interrupt(s) immediately begin generating, executed in “first in - first out” order in the queue.

`IEnable` is active by default. `IEnable` is automatically set

- when using the restart mode **Reset RAPID**
- when loading a new program or a new module
- when starting program execution from the beginning
- when moving the program pointer to `main`
- when moving the program pointer to a routine
- when moving the program pointer in such a way that the execution order is lost
- after executing one cycle (passing `main`) or executing `ExitCycle`.

Syntax

```
IDisable';'
```

Related information

For information about	See
Summary of interrupts	<i>Technical reference manual - RAPID Overview</i>
More information about interrupt management	<i>Technical reference manual - RAPID Overview</i>
Permitting interrupts	IEnable - Enables interrupts on page 254

1 Instructions

1.98 IEnable - Enables interrupts *RobotWare Base*

1.98 IEnable - Enables interrupts

Usage

`IEnable(Interrupt Enable)` is used to enable interrupts during program execution.

Basic examples

The following example illustrates the instruction `IEnable`:

Example 1

```
IDisable;  
FOR i FROM 1 TO 100 DO  
    character[i]:=ReadBin(sensor);  
ENDFOR  
IEnable;
```

No interrupts are permitted while reading from the sensor. When it has finished reading, interrupts are once more permitted.

Program execution

Interrupts which occur during the time in which an `IDisable` instruction is in effect are placed in a queue. When interrupts are permitted once more (`IEnable`), the interrupt(s) then immediately begin generating, executed in “first in - first out” order in the queue. Program execution then continues in the ordinary program and interrupts which occur after this are dealt with as soon as they occur.

Interrupts are always permitted when a program is started from the beginning. Interrupts disabled by the `ISleep` instruction are not affected by the `IEnable` instruction.

Syntax

```
IEnable';'
```

Related information

For information about	See
Summary of interrupts	<i>Technical reference manual - RAPID Overview</i>
More information about interrupt management	<i>Technical reference manual - RAPID Overview</i>
Permitting no interrupts	IDisable - Disables interrupts on page 253

1.99 IError - Orders an interrupt on errors

Usage

`IError` (*Interrupt Errors*) is used to order and enable an interrupt when an error occurs.

Error, warning, or state change can be logged with `IError`.

Basic examples

The following example illustrates the instruction `IError`:

See also [More examples on page 256](#).

Example 1

```
VAR intnum err_int;
...
PROC main()
  CONNECT err_int WITH err_trap;
  IError COMMON_ERR, TYPE_ALL, err_int;
```

Orders an interrupt in **RAPID** and execution of the trap routine `err_trap` each time an error, warning, or state change is generated in the system.

Arguments

```
IError ErrorDomain [ \ErrorId ] ErrorType Interrupt
```

ErrorDomain

Data type: `errdomain`

The error domain that is to be monitored. See predefined data of type `errdomain`. To specify any domain use `COMMON_ERR`.

[\ErrorId]

Data type: `num`

Optionally, the number of a specific error that is to be monitored. The error number must be specified without the first digit (error domain) of the complete error number. For example, **10008 Program restarted**, must be specified as *0008* or only *8*.

ErrorType

Data type: `errtype`

The type of event such as error, warning, or state change that is to be monitored. See predefined data of type `errtype`. To specify any type use `TYPE_ALL`.

Interrupt

Data type: `intnum`

The interrupt identity. This should have been previously connected to a trap routine by means of the instruction `CONNECT`.

Continues on next page

1 Instructions

1.99 IError - Orders an interrupt on errors

RobotWare Base

Continued

Program execution

The corresponding trap routine is automatically called when an error occurs in the specified domain of the specified type and optionally with the specified error number. When this has been executed, program execution continues from where the interrupt occurred.

More examples

More examples of the instruction `IError` are illustrated below.

```
VAR intnum err_interrupt;  
VAR trapdata err_data;  
VAR errdomain err_domain;  
VAR num err_number;  
VAR errtype err_type;  
PROC main()  
    CONNECT err_interrupt WITH trap_err;  
    IError COMMON_ERR, TYPE_ERR, err_interrupt;  
    ...  
    IDelete err_interrupt;  
    ...  
ENDPROC  
TRAP trap_err  
    GetTrapData err_data;  
    ReadErrData err_data, err_domain, err_number, err_type;  
    ! Set domain no 1 ... 11  
    SetGO go_err1, err_domain;  
    ! Set error no 1 ...9999  
    SetGO go_err2, err_number;  
ENDTRAP
```

When an error occurs (only error, not warning or state change) the error number is retrieved in the trap routine, and its value is used to set 2 groups of digital output signals.

Limitation

It is not possible to order an interrupt on internal errors.

In a task of type normal, the event will be thrown away during a program stop, which means that not all events can be fetched in a normal task. To fetch all events the task must be of static or semi-static type.

The same variable for interrupt identity cannot be used more than once without first deleting it. Interrupts should therefore be handled as shown in one of the alternatives below.

```
VAR intnum err_interrupt;  
PROC main ( )  
    CONNECT err_interrupt WITH err_trap;  
    IError COMMON_ERR, TYPE_ERR, err_interupt;  
    WHILE TRUE DO  
    :  
    :  
    ENDWHILE
```

Continues on next page

```
ENDPROC
```

Interrupts are activated at the beginning of the program. These instructions in the beginning are then kept outside the main flow of the program.

```
VAR intnum err_interrupt;
PROC main ( )
  CONNECT err_interrupt WITH err_trap;
  IError COMMON_ERR, TYPE_ERR, err_interupt;
  :
  :
  IDelete err_interrupt;
ENDPROC
```

The interrupt is deleted at the end of the program and is then reactivated. Note, in this case, that the interrupt is inactive for a short period.

Syntax

```
IError
  [ErrorDomain ':='] <expression (IN) of errdomain>
  ['\ErrorId' :=] <expression (IN) of num>', '
  [ErrorType' :=] <expression (IN) of errtype> ', '
  [Interrupt' :=] <variable (VAR) of intnum>;'
```

Related information

For information about	See
Summary of interrupts	<i>Technical reference manual - RAPID Overview</i>
More information on interrupt management	<i>Technical reference manual - RAPID Overview</i>
Error domains, predefined constants	errdomain - Error domain on page 1651
Error types, predefined constants	errtype - Error type on page 1662
Get interrupt data for current trap	GetTrapData - Get interrupt data for current trap routine on page 239
Gets information about an error	ReadErrData - Gets information about an error on page 590
<i>Advanced RAPID</i>	<i>Application manual - Controller software IRC5</i>

1 Instructions

1.100 IF - If a condition is met, then ...; otherwise ...
RobotWare Base

1.100 IF - If a condition is met, then ...; otherwise ...

Usage

IF is used when different instructions are to be executed depending on whether a condition is met or not.

Basic examples

Basic examples of the instruction IF are illustrated below.

See also [More examples on page 259](#).

Example 1

```
IF reg1 > 5 THEN
  Set do1;
  Set do2;
ENDIF
```

The signals do1 and do2 are set only if reg1 is greater than 5.

Example 2

```
IF reg1 > 5 THEN
  Set do1;
  Set do2;
ELSE
  Reset do1;
  Reset do2;
ENDIF
```

The signals do1 and do2 are set or reset depending on whether reg1 is greater than 5 or not.

Arguments

```
IF Condition THEN ...
  {ELSEIF Condition THEN ...}
  [ELSE ...]
ENDIF
```

Condition

Data type: bool

The condition that must be satisfied for the instructions between THEN and ELSE/ELSEIF to be executed.

Program execution

The conditions are tested in sequential order, until one of them is satisfied. Program execution continues with the instructions associated with that condition. If none of the conditions are satisfied, program execution continues with the instructions following ELSE. If more than one condition is met, only the instructions associated with the first of those conditions are executed.

Continues on next page

More examples

More examples of how to use the instruction `IF` are illustrated below.

Example 1

```
IF counter > 100 THEN
  counter := 100;
ELSEIF counter < 0 THEN
  counter := 0;
ELSE
  counter := counter + 1;
ENDIF
```

`counter` is incremented by 1. However, if the value of `counter` is outside the limit 0-100, `counter` is assigned the corresponding limit value.

Syntax

```
IF <conditional expression> THEN
  <statement list>
{ ELSEIF <conditional expression> THEN
  <statement list> | <EIT> }
[ ELSE
  <statement list> ]
ENDIF
```

Related information

For information about	See
Conditions (logical expressions)	<i>Technical reference manual - RAPID Overview</i>

1 Instructions

1.101 Incr - Increments by 1
RobotWare Base

1.101 Incr - Increments by 1

Usage

`Incr` is used to add 1 to a numeric variable or persistent.

Basic examples

The following example illustrates the instruction `Incr`:

See also [More examples on page 260](#).

Example 1

```
Incr reg1;
```

1 is added to `reg1`, i.e. `reg1:=reg1+1`.

Arguments

`Incr` Name | Dname

Name

Data type: num

The name of the variable or persistent to be changed.

Dname

Data type: dnum

The name of the variable or persistent to be changed.

More examples

More examples of the instruction `Incr` are illustrated below.

Example 1

```
VAR num no_of_parts:=0;
...
WHILE stop_production=0 DO
  produce_part;
  Incr no_of_parts;
  TPWrite "No of produced parts= "\Num:=no_of_parts;
ENDWHILE
```

The number of parts produced is updated each cycle on the FlexPendant. Production continues to run as long as the input signal `stop_production` is not set.

Example 2

```
VAR dnum no_of_parts:=0;
...
WHILE stop_production=0 DO
  produce_part;
  Incr no_of_parts;
  TPWrite "No of produced parts= "\Dnum:=no_of_parts;
ENDWHILE
```

Continues on next page

The number of parts produced is updated each cycle on the FlexPendant.
Production continues to run as long as the input signal `stop_production` is not set.

Syntax

```
Incr  
  [ Name ':=' ] < var or pers (INOUT) of num >  
  | [ Dname ':=' ] < var or pers (INOUT) of dnum > ' ;'
```

Related information

For information about	See
Decrementing a variable by 1	Decr - Decrements by 1 on page 186
Adding any value to a variable	Add - Adds a numeric value on page 32
Changing data using an arbitrary expression, for example, multiplication	":=" - Assigns a value on page 41

1 Instructions

1.102 IndAMove - Independent absolute position movement *Independent Axis*

1.102 IndAMove - Independent absolute position movement

Usage

`IndAMove` (*Independent Absolute Movement*) is used to change an axis to independent mode and move the axis to a specific position.

An independent axis is an axis moving independently of other axes in the robot system. As program execution immediately continues, it is possible to execute other instructions (including positioning instructions) during the time the independent axis is moving.

If the axis is to be moved within a revolution, the instruction `IndRMove` should be used instead. If the move is to occur a short distance from the current position, the instruction `IndDMove` must be used.

This instruction can only be used in the main task `T_ROB1` or, if in a *MultiMove* system, in Motion tasks.

Basic examples

The following example illustrates the instruction `IndAMove`:

See also [More examples on page 264](#).

Example 1

```
IndAMove Station_A,2\ToAbsPos:=p4,20;
```

Axis 2 of `Station_A` is moved to the position `p4` at the speed 20 degrees/s.

Arguments

```
IndAMove MecUnit Axis [\ToAbsPos] | [\ToAbsNum] Speed [\Ramp]
```

`MecUnit`

Mechanical Unit

Data type: `mecunit`

The name of the mechanical unit.

`Axis`

Data type: `num`

The number of the current axis for the mechanical unit (1-6)

`[\ToAbsPos]`

To Absolute Position

Data type: `robtarg`

Axis position specified as a `robtarg`. Only the component for this specific `Axis` is used. The value is used as an absolute position value in degrees (mm for linear axes).

The axis position will be affected if the axis is displaced using the instruction `EOffsSet` or `EOffsOn`.

For robot axes the argument `\ToAbsNum` is to be used instead.

`[\ToAbsNum]`

To Absolute Numeric value

Continues on next page

Data type: num

Axis position defined in degrees (mm for linear axis).

Using this argument, the position will NOT be affected by any displacement, for example, `EOffsSet` or `PDispOn`.

Same function as `\ToAbsPos` but the position is defined as a numeric value to make it easy to manually change the position.

Speed

Data type: num

Axis speed in degrees/s (mm/s for linear axis).

[`\Ramp`]

Data type: num

Decrease acceleration and deceleration from maximum performance (1-100%, 100%=maximum performance).

Program execution

When `IndAMove` is executed the specified axis moves with the programmed speed to the specified axis position. If `\Ramp` is programmed there will be a reduction of acceleration/deceleration.

To change the axis back to normal mode the `IndReset` instruction is used. In connection with this the logical position of the axis can be changed so that a number of revolutions are erased from the position, for example, to avoid rotating back for the next movement.

The speed can be altered by executing another `IndAMove` instruction (or another `IndXMove` instruction). If a speed in the opposite direction is selected the axis stops and then accelerates to the new speed and direction.

For stepwise execution of the instruction the axis is set in independent mode only. The axis begins its movement when the next instruction is executed and continues as long as program execution takes place. For more information see *RAPID reference manual - RAPID overview, section Motion and I/O principles - Positioning during program execution - Independent axes*.

When the program pointer is moved to the start of the program or to a new routine all axes are automatically set to normal, without changing the measurement system (equivalent to executing the instruction `IndReset\Old`).



Note

An `IndAMove` instruction after an `IndCMove` operation can result in the axis spinning back to the movement performed in the `IndCMove` instruction. To prevent this, use an `IndReset` instruction before the `IndAMove`, or use an `IndRMove` instruction.

Continues on next page

1 Instructions

1.102 IndAMove - Independent absolute position movement

Independent Axis

Continued

Error handling

The following recoverable errors can be generated. The errors can be handled in an ERROR handler. The system variable `ERRNO` will be set to:

Name	Cause of error
<code>ERR_AXIS_ACT</code>	The axis is not activated.

More examples

More examples of the instruction `IndAMove` are illustrated below.

Example 1

```
ActUnit Station_A;  
weld_stationA;  
IndAMove Station_A,1\ToAbsNum:=90,20\Ramp:=50;  
ActUnit Station_B;  
weld_stationB_1;  
WaitUntil IndInpos(Station_A,1) = TRUE;  
WaitTime 0.2;  
DeactUnit Station_A;  
weld_stationB_2;
```

Station_A is activated and the welding is started in station A.

Station_A (axis 1) is then moved to the 90 degrees position while the robot is welding in station B. The speed of the axis is 20 degrees/s. The speed is changed with acceleration/deceleration reduced to 50% of max performance.

When station A reaches this position it is deactivated, and reloading can take place in the station at the same time as the robot continues to weld in station B.

Limitations

Axes in independent mode cannot be jogged. If an attempt is made to execute the axis manually, the axis will not move and an error message will be displayed. Execute an `IndReset` instruction or move the program pointer to main to leave independent mode.

If a power fail occurs when an axis is in independent mode the program cannot be restarted. An error message is displayed and the program must be started from the beginning.

The instruction is not advisable for coupled robot wrist axes (see *RAPID reference manual - RAPID overview, section Motion and I/O principles - Positioning during program execution - Independent axes*).

Syntax

```
IndAMove  
[MecUnit ':='] <variable (VAR) of mecunit>','  
[Axis ':='] <expression (IN) of num>  
['\ ' ToAbsPos ':=' <expression (IN) of rotarget>  
|['\ ' ToAbsNum ':=' <expression (IN) of num>'],'  
[Speed ':='] <expression (IN) of num>  
['\ ' Ramp ':=' <expression (IN) of num>]';'
```

Continues on next page

Related information

For information about	See
Independent axes in general	<i>Technical reference manual - RAPID Overview</i>
<i>Independent Axis</i>	<i>Application manual - Controller software IRC5</i>
Change back to normal mode	IndReset - Independent reset on page 273
Reset the measurement system	IndReset - Independent reset on page 273
Other independent axis movement	IndRMove - Independent relative position movement on page 278 IndDMove - Independent delta position movement on page 270 IndCMove - Independent continuous movement on page 266
Check the speed status for independent axes	IndSpeed - Independent speed status on page 1332
Check the position status for independent axes	IndInpos - Independent axis in position status on page 1330
Activating independent joints	<i>Technical reference manual - System parameters, topic Motion, type Arm</i>

1 Instructions

1.103 IndCMove - Independent continuous movement *Independent Axis*

1.103 IndCMove - Independent continuous movement

Usage

IndCMove (*Independent Continuous Movement*) is used to change an axis to independent mode and start the axis moving continuously at a specific speed. An independent axis is an axis moving independently of other axes in the robot system. As program execution continues immediately it is possible to execute other instructions (including positioning instructions) during the time the independent axis is moving.

This instruction can only be used in the main task T_ROB1 or, if in a *MultiMove* system, in Motion tasks.

Basic examples

The following example illustrates the instruction IndCMove:

See also [More examples on page 267](#).

Example 1

```
IndCMove Station_A,2,-30.5;
```

Axis 2 of Station_A starts to move in a negative direction at a speed of 30.5 degrees/s.

Arguments

```
IndCMove MecUnit Axis Speed [\Ramp]
```

MecUnit

Mechanical Unit

Data type: mecunit

The name of the mechanical unit.

Axis

Data type: num

The number of the current axis for the mechanical unit (1-6).

Speed

Data type: num

Axis speed in degrees/s (mm/s for linear axis).

The direction of movement is specified with the sign of the speed argument.

[\Ramp]

Data type: num

Decrease acceleration and deceleration from maximum performance (1-100%,100%=maximumperformance).

Program execution

When IndCMove is executed the specified axis starts to move with the programmed speed. The direction of movement is specified as the sign of the speed argument. If \Ramp is programmed there will be a reduction of acceleration/deceleration.

Continues on next page

To change the axis back to normal mode the `IndReset` instruction is used. The logical position of the axis can be changed in connection with this - a number of full revolutions can be erased, for example, to avoid rotating back for the next movement.

The speed can be changed by executing a further `IndCMove` instruction. If a speed in the opposite direction is ordered the axis stops and then accelerates to the new speed and direction. To stop the axis, speed argument 0 can be used. It will then still be in independent mode.

During stepwise execution of the instruction the axis is set in independent mode only. The axis starts its movement when the next instruction is executed and continues as long as program execution continues. For more information see *RAPID reference manual - RAPID overview, section Motion and I/O principles - Positioning during program execution - Independent axes*.

When the program pointer is moved to the beginning of the program or to a new routine, all axes are set automatically to normal mode without changing the measurement system (equivalent to executing the instruction `IndReset\Old`).

Error handling

The following recoverable errors can be generated. The errors can be handled in an `ERROR` handler. The system variable `ERRNO` will be set to:

Name	Cause of error
<code>ERR_AXIS_ACT</code>	The axis is not activated.

More examples

More examples of the instruction `IndCMove` are illustrated below.

```

IndCMove Station_A,2,20;
WaitUntil IndSpeed(Station_A,2 \InSpeed) = TRUE;
WaitTime 0.2;
MoveL p10, v1000, fine, tool1;
IndCMove Station_A,2,-10\Ramp:=50;
MoveL p20, v1000, z50, tool1;
IndRMove Station_A,2 \ToRelPos:=p1 \Short,10;
MoveL p30, v1000, fine, tool1;
WaitUntil IndInpos(Station_A,2 ) = TRUE;
WaitTime 0.2;
IndReset Station_A,2 \RefPos:=p40\Short;
MoveL p40, v1000, fine, tool1;

```

Axis 2 of `Station_A` starts to move in a positive direction at a speed of 20 degrees/s. When this axis has reached the selected speed the robot axes start to move.

When the robot reaches position `p10` the external axis changes direction and rotates at a speed of 10 degrees/s. The change of speed is performed with acceleration/deceleration reduced to 50% of maximum performance. At the same time, the robot executes towards `p20`.

Axis 2 of `Station_A` is then stopped as quickly as possible in position `p1` within the current revolution.

Continues on next page

1 Instructions

1.103 IndCMove - Independent continuous movement

Independent Axis

Continued

When axis 2 has reached this position, and the robot has stopped in position p30, axis 2 returns to normal mode again. The measurement system offset for this axis is changes a whole number of axis revolutions so that the actual position is as close as possible to p40.

When the robot is then moved to position p40, axis 2 of Station_A will be moved by the instruction MoveL p40 via the shortest route to position p40 (max ±180 degrees).

Limitations

The resolution of the axis position worsens the further it is moved from its logical zero position (usually the middle of the working area). To achieve high resolution again the logical working area can be set to zero with the instruction IndReset. For more information see *RAPID reference manual - RAPID overview*, section *Motion and I/O Principles - Positioning during program execution - Independent axes*.

Axes in independent mode cannot be jogged. If an attempt is made to execute the axis manually, the axis will not move, and an error message will be displayed. Execute an IndReset instruction or move the program pointer to main to leave independent mode.

If a power fail occurs when the axis is in independent mode the program cannot be restarted. An error message is displayed, and the program must be started from the beginning.

The instruction is not advisable for coupled robot wrist axes (see *RAPID Reference Manual- RAPID overview*, section *Motion and I/O principles - Positioning during program execution- Independent Axes*).

Syntax

```
IndCMove
[MecUnit ':=' ] <variable (VAR) of mecunit> ','
[Axis ':=' ] <expression (IN) of num> ','
[Speed ':=' ] <expression (IN) of num>
['\ ' Ramp ':=' <expression (IN) of num> ] ;'
```

Related information

For information about	See
Independent axes in general	<i>Technical reference manual - RAPID Overview</i>
<i>Independent Axis</i>	<i>Application manual - Controller software IRC5</i>
Change back to normal mode	IndReset - Independent reset on page 273
Reset the measurement system	IndReset - Independent reset on page 273
Other independent axis movement	IndAMove - Independent absolute position movement on page 262 IndRMove - Independent relative position movement on page 278 IndDMove - Independent delta position movement on page 270

Continues on next page

1.103 IndCMove - Independent continuous movement

Independent Axis

Continued

For information about	See
Check the speed status for independent axes	IndSpeed - Independent speed status on page 1332
Check the position status for independent axes	IndInpos - Independent axis in position status on page 1330
Activating independent joints	<i>Technical reference manual - System parameters, topic Motion, type Arm</i>

1 Instructions

1.104 IndDMove - Independent delta position movement *Independent Axis*

1.104 IndDMove - Independent delta position movement

Usage

IndDMove(*Independent Delta Movement*) is used to change an axis to independent mode and move the axis to a specific distance.

An independent axis is an axis moving independently of other axes in the robot system. As program execution continues immediately it is possible to execute other instructions (including positioning instructions) during the time the independent axis is moving.

If the axis is to be moved to a specific position, the instruction IndAMove or IndRMove must be used instead.

This instruction can only be used in the main task T_ROB1 or, if in a *MultiMove* system, in Motion tasks.

Basic examples

The following example illustrates the instruction IndDMove:

See also [More examples on page 271](#).

Example 1

```
IndDMove Station_A,2,-30,20;
```

Axis 2 of Station_A is moved 30 degrees in a negative direction at a speed of 20 degrees/s.

Arguments

```
IndDMove MecUnit Axis Delta Speed [\Ramp]
```

MecUnit

Mechanical Unit

Data type: mecunit

The name of the mechanical unit.

Axis

Data type: num

The number of the current axis for the mechanical unit (1-6).

Delta

Data type: num

The distance which the current axis is to be moved, expressed in degrees (mm for linear axes). The sign specifies the direction of movement.

Speed

Data type: num

Axis speed in degrees/s (mm/s for linear axis).

[\Ramp]

Data type: num

Continues on next page

Decrease acceleration and deceleration from maximum performance (1-100%,100%=maximumperformance).

Program execution

When `IndDMove` is executed the specified axis moves with the programmed speed to the specified distance. The direction of movement is specified as the sign of the `Delta` argument. If `\Ramp` is programmed there will be a reduction of acceleration/deceleration.

If the axis is moving the new position is calculated from the momentary position of the axis when the instruction `IndDMove` is executed. If an `IndDMove` instruction with distance 0 is executed and the axis is already moving position, the axis will stop and then move back to the position which the axis had when the instruction was executed.

To change the axis back to normal mode the `IndReset` instruction is used. The logical position of the axis can be changed in connection with this - a number of full revolutions can be erased from the position, for example, to avoid rotating back for the next movement.

The speed can be changed by running a further `IndDMove` instruction (or another `IndXMove` instruction). If a speed in the opposite direction is selected the axis stops and then accelerates to the new speed and direction.

During stepwise execution of the instruction the axis is set in independent mode only. The axis starts its movement when the next instruction is executed and continues as long as program execution continues. For more information see *RAPID reference manual - RAPID overview, section Motion and I/O principles - Positioning during program execution - Independent axes*.

When the program pointer is moved to the beginning of the program, or to a new routine, all axes are automatically set to normal mode without changing the measurement system (equivalent to running the instruction `IndReset \Old`).

Error handling

The following recoverable errors can be generated. The errors can be handled in an ERROR handler. The system variable `ERRNO` will be set to:

Name	Cause of error
<code>ERR_AXIS_ACT</code>	The axis is not activated.

More examples

More examples of the instruction `IndDMove` are illustrated below.

Example 1

```
IndAMove ROB_1,6\ToAbsNum:=90,20;
WaitUntil IndInpos(ROB_1,6) = TRUE;
WaitTime 0.2;
IndDMove Station_A,2,-30,20;
WaitUntil IndInpos(ROB_1,6) = TRUE;
WaitTime 0.2;
IndDMove ROB_1,6,400,20;
```

Continues on next page

1 Instructions

1.104 IndDMove - Independent delta position movement

Independent Axis

Continued

Axis 6 of the robot is moved to the following positions:

- 90 degrees
- 60 degrees
- 460 degrees (1 revolution + 100 degrees)

Limitations

Axes in independent mode cannot be jogged. If an attempt is made to execute the axis manually the axis will not move, and an error message will be displayed. Execute an `IndReset` instruction or move the program pointer to main to leave independent mode.

If a loss of power fail occurs when the axis is in independent mode the program cannot be restarted. An error message is displayed, and the program must be started from the beginning.

The instruction is not advisable for coupled robot wrist axes (see *RAPID reference manual - RAPID overview*, section *Motion and I/O principles - Positioning during program execution - Independent axes*).

Syntax

```
IndDMove
[MecUnit ':='] <variable (VAR) of mecunit>', '
[Axis ':='] <expression (IN) of num>', '
[Delta ':='] <expression (IN) of num>', '
[Speed '='] <expression (IN) of num>
['\' Ramp ':=' <expression (IN) of num>]';'
```

Related information

For information about	See
Independent axes in general	<i>Technical reference manual - RAPID Overview</i>
<i>Independent Axis</i>	<i>Application manual - Controller software IRC5</i>
Change back to normal mode	IndReset - Independent reset on page 273
Reset the measurement system	IndReset - Independent reset on page 273
Other independent axis movement	IndAMove - Independent absolute position movement on page 262 IndRMove - Independent relative position movement on page 278 IndCMove - Independent continuous movement on page 266
Check the speed status for independent axes	IndSpeed - Independent speed status on page 1332
Check the position status for independent axes	IndInpos - Independent axis in position status on page 1330
Activating independent joints	<i>Technical reference manual - System parameters</i> , topic <i>Motion</i> , type <i>Arm</i>

1.105 IndReset - Independent reset

Usage

IndReset (*Independent Reset*) is used to change an independent axis back to normal mode. At the same time, the measurement system for rotational axes can be moved a number of axis revolutions.

This instruction can only be used in the main task T_ROB1 or, if in a *MultiMove* system, in Motion tasks.

Basic examples

The following example illustrates the instruction IndReset:

See also [More examples on page 275](#).

```
IndCMove Station_A,2,5;
MoveL *,v1000,fine,tool1;
IndCMove Station_A,2,0;
WaitUntil IndSpeed(Station_A,2\ZeroSpeed);
WaitTime 0.2
IndReset Station_A,2;
```

Axis 2 of Station_A is first moved in independent mode and then changed back to normal mode. The axis will keep its position.



Note

The current independent axis and the normal axes should not move when the instruction IndReset is executed. That is why previous position is a stop point, and an IndCMove instruction is executed at zero speed. Furthermore, a pause of 0.2 seconds is used to ensure that the correct status has been achieved.

Arguments

```
IndReset MecUnit Axis [\RefPos] | [\RefNum] [\Short] | [\Fwd]
|[\Bwd] | \Old]
```

MecUnit

Mechanical Unit

Data type: mecunit

The name of the mechanical unit.

Axis

Data type: num

The number of the current axis for the mechanical unit (1-6).

[\RefPos]

Reference Position

Data type: robtarget

Reference axis position specified as a robtarget. Only the component for this specific Axis is used. The position must be inside the normal working range.

For robot axes, the argument \RefNum is to be used instead.

Continues on next page

1 Instructions

1.105 IndReset - Independent reset

Independent Axis

Continued

The argument is only to be defined together with the argument `\Short`, `\Fwd` or `\Bwd`. It is not allowed together with the argument `\Old`.

[`\RefNum`]

Reference Numeric value

Data type: num

Reference axis position defined in degrees (mm for linear axis). The position must be inside the normal working range.

The argument is only to be defined together with the argument `\Short`, `\Fwd` or `\Bwd`. It is not allowed together with the argument `\Old`.

Same function as `\RefPos` but the position is defined as a numeric value to make it easy to change the position manually.

[`\Short`]

Data type: switch

The measurement system will change a whole number of revolutions on the axis side so that the axis will be as close as possible to the specified `\RefPos` or `\RefNum` position. If a positioning instruction with the same position is executed after `IndReset` the axis will travel the shortest route, less than ± 180 degrees, to reach the position.

[`\Fwd`]

Forward

Data type: switch

The measurement system will change a whole number of revolutions on the axis side so that the reference position will be on the positive side of the specified `\RefPos` or `\RefNum` position. If a positioning instruction with the same position is executed after `IndReset`, the axis will turn in a positive direction less than 360 degrees to reach the position.

[`\Bwd`]

Backward

Data type: switch

The measurement system will change a whole number of revolutions on the axis side so that the reference position will be on the negative side of the specified `\RefPos` or `\RefNum` position. If a positioning instruction with the same position is executed after `IndReset`, the axis will turn in a negative direction less than 360 degrees to reach the position.

[`\Old`]

Data type: switch

Keeps the old position.

Continues on next page

**Note**

Resolution is decreased in positions far away from zero.

If no argument `\Short`, `\Fwd`, `\Bwd` or `\Old` is specified - `\Old` is used as default value.

Program execution

When `IndReset` is executed it changes the independent axis back to normal mode. At the same time the measurement system for the axis can be moved by a whole number of axis revolutions.

The instruction may also be used in normal mode to change the measurement system.

**Note**

The position is used only to adjust the measurement system - the axis will not move to the position.

Error handling

The following recoverable errors can be generated. The errors can be handled in an ERROR handler. The system variable `ERRNO` will be set to:

Name	Cause of error
<code>ERR_AXIS_ACT</code>	The axis is not activated.
<code>ERR_AXIS_MOVING</code>	The axis is moving.

More examples

More examples of the instruction `IndReset` are illustrated below.

Example 1

```
IndAMove Station_A,1\ToAbsNum:=750,50;
WaitUntil IndInpos(Station_A,1);
WaitTime 0.2;
IndReset Station_A,1 \RefNum:=0 \Short;
IndAMove Station_A,1\ToAbsNum:=750,50;
WaitUntil IndInpos(Station_A,1);
WaitTime 0.2;
IndReset Station_A,1 \RefNum:=300 \Short;
```

Axis 1 in `Station_A` is first moved independently to the 750 degrees position (2 revolutions and 30 degrees). At the same time as it changes to normal mode the logical position is set to 30 degrees.

Axis 1 in `Station_A` is subsequently moved to the 750 degrees position (2 revolutions and 30 degrees). At the same time as it changes to normal mode the logical position is set to 390degrees (1 revolution and 30 degrees).

Continues on next page

1 Instructions

1.105 IndReset - Independent reset

Independent Axis

Continued

Limitations

The instruction may only be executed when all active axes running in normal mode are standing still. All active axes in every mechanical unit connected to the same motion planner need to stand still. The independent mode axis which is going to be changed to normal mode must also be stationary. For axes in normal mode this is achieved by executing a move instruction with the argument `fine`. The independent axis is stopped by an `IndCMove` with `Speed:=0` (followed by a wait period of 0.2 seconds), `IndRMove`, `IndAMove`, or `IndDMove` instruction.

The resolution of positions is decreased when moving away from logical position 0. An axis which progressively rotates further and further from the position 0 should thus be set to zero using the instruction `IndReset` with an argument other than `\Old`.

The measurement system cannot be changed for linear axes.

To ensure a proper start after `IndReset` of an axis with a relative measured measurement system (synchronization switches) an extra time delay of 0.12 seconds must be added after the `IndReset` instruction.

Only robot axis 6 can be used as independent axis. The `IndReset` instruction can also be used for axis 4 on IRB 1600, 2600 and 4600 models (not for ID version). If `IndReset` is used on robot axis 4 then axis 6 must not be in the independent mode.

If this instruction is preceded by a move instruction, that move instruction must be programmed with a stop point (`zonedata fine`), not a fly-by point. Otherwise restart after power failure will not be possible.

`IndReset` cannot be executed in a RAPID routine connected to any of following special system events: `PowerOn`, `Stop`, `QStop`, `Restart` or `Step`.

`IndReset` only switches the independent state for an axis. It cannot be used to stop an independent movement. To stop an independent movement it has to reach a stop condition or the user has to for example move PP to main.

Syntax

```
IndReset
[MecUnit ':=' ] <variable (VAR) of mecunit> ','
[Axis ':=' ] <expression (IN) of num>
['\ ' RefPos ':=' <expression (IN) of robtarger> ] |
['\ ' RefNum ':=' <expression (IN) of num> ]
['\ ' Short] | ['\ ' Fwd] | ['\ ' Bwd] | ['\ ' Old] ;'
```

Related information

For information about	See
Independent axes in general	<i>Technical reference manual - RAPID Overview</i>
<i>Independent Axis</i>	<i>Application manual - Controller software IRC5</i>

Continues on next page

For information about	See
Change an axis to independent mode	IndAMove - Independent absolute position movement on page 262 IndCMove - Independent continuous movement on page 266 IndDMove - Independent delta position movement on page 270 IndRMove - Independent relative position movement on page 278
Check the speed status for independent axes	IndSpeed - Independent speed status on page 1332
Check the position status for independent axes	IndInpos - Independent axis in position status on page 1330
Activating independent joints	<i>Technical reference manual - System parameters, topic Motion, type Arm</i>

1 Instructions

1.106 IndRMove - Independent relative position movement *Independent Axis*

1.106 IndRMove - Independent relative position movement

Usage

`IndRMove` (*Independent Relative Movement*) is used to change a rotational axis to independent mode and move the axis to a specific position within one revolution. An independent axis is an axis moving independently of other axes in the robot system. As program execution continues immediately it is possible to execute other instructions (including positioning instructions) during the time the independent axis is moving.

If the axis is to be moved to an absolute position (several revolutions) or if the axis is linear, the instruction `IndAMove` is used instead. If the movement is to take place a certain distance from the current position the instruction `IndDMove` must be used.

This instruction can only be used in the main task `T_ROB1` or, if in a *MultiMove* system, in Motion tasks.

Basic examples

The following example illustrates the instruction `IndRMove`:

See also [More examples on page 280](#).

Example 1

```
IndRMove Station_A,2\ToRelPos:=p5 \Short,20;
```

Axis 2 of `Station_A` is moved the shortest route to position `p5` within one revolution (maximum rotation ± 180 degrees) at a speed of 20 degrees/s.

Arguments

```
IndRMove MecUnit Axis [\ToRelPos] | [\ToRelNum] [\Short] | [\Fwd]  
| [\Bwd] Speed [\Ramp]
```

MecUnit

Mechanical Unit

Data type: `mecunit`

The name of the mechanical unit.

Axis

Data type: `num`

The number of the current axis for the mechanical unit (1-6).

[`\ToRelPos`]

To Relative Position

Data type: `robtarget`

Axis position specified as a `robtarget`. Only the component for this specific `Axis` is used. The value is used as a position value in degrees within one axis revolution. This means that the axis moves less than one revolution.

The axis position will be affected if the axis is displaced using the instruction `EOffsSet` or `EOffsOn`.

Continues on next page

For robot axes the argument `\ToRelNum` is to be used instead.

[`\ToRelNum`]

To Relative Numeric value

Data type: num

Axis position defined in degrees.

Using this argument the position will NOT be affected by any displacement, e.g. `EOffsSet` or `PDispOn`.

Same function as `\ToRelPos` but the position is defined as a numeric value to make it easy to change the position manually.

[`\Short`]

Data type: switch

The axis is moved the shortest route to the new position. This means that the maximum rotation will be 180 degrees in any direction. The direction of movement therefore depends on the current location of the axis.

[`\Fwd`]

Forward

Data type: switch

The axis is moved in a positive direction to the new position. This means that the maximum rotation will be 360 degrees and always in a positive direction (increased position value).

[`\Bwd`]

Backward

Data type: switch

The axis is moved in a negative direction to the new position. This means that the maximum rotation will be 360 degrees and always in a negative direction (decreased position value).

If `\Short`, `\Fwd` or `\Bwd` argument is omitted, `\Short` is used as default value.

Speed

Data type: num

Axis speed in degrees/s.

[`\Ramp`]

Data type: num

Decrease acceleration and deceleration from maximum performance (1-100%,100%=maximumperformance).

Program execution

When `IndRMove` is executed the specified axis moves with the programmed speed to the specified axis position, but only a maximum of one revolution. If `\Ramp` is programmed there will be a reduction of acceleration/deceleration.

To change the axis back to normal mode the `IndReset` instruction is used. The logical position of the axis can be changed in connection with this - a number of

Continues on next page

1 Instructions

1.106 IndRMove - Independent relative position movement

Independent Axis

Continued

full revolutions can be erased from the position, for example, to avoid rotating back for the next movement.

The speed can be changed by running a further `IndRMove` instruction (or another `IndXMove` instruction). If a speed in the opposite direction is selected the axis stops and then accelerates to the new speed and direction.

During stepwise execution of the instruction the axis is set in independent mode only. The axis starts its movement when the next instruction is executed and continues as long as program execution continues. For more information see *RAPID reference manual - RAPID overview, section Motion and I/O principles - Positioning during program execution- Independent axes*.

When the program pointer is moved to the beginning of the program or to a new routine, all axes are automatically set to normal mode without changing the measurement system (equivalent to running the instruction `IndReset \Old`).

Error handling

The following recoverable errors can be generated. The errors can be handled in an ERROR handler. The system variable `ERRNO` will be set to:

Name	Cause of error
<code>ERR_AXIS_ACT</code>	The axis is not activated.

More examples

More examples of the instruction `IndRMove` are illustrated below.

Example 1

```
IndRMove Station_A,1\ToRelPos:=p5 \Fwd,20\Ramp:=50;
```

Axis 1 of `Station_A` starts to move in a positive direction to the position `p5` within one revolution (maximum rotation 360 degrees) at a speed of 20 degrees/s. The speed is changed with acceleration/deceleration reduced to 50% of maximum performance.

```
IndAMove Station_A,1\ToAbsNum:=90,20;  
WaitUntil IndInpos(Station_A,1) = TRUE;  
IndRMove Station_A,1\ToRelNum:=80 \Fwd,20;  
WaitTime 0.2;  
WaitUntil IndInpos(Station_A,1) = TRUE;  
WaitTime 0.2;  
IndRMove Station_A,1\ToRelNum:=50 \Bwd,20;  
WaitUntil IndInpos(Station_A,1) = TRUE;  
WaitTime 0.2;  
IndRMove Station_A,1\ToRelNum:=150 \Short,20;  
WaitUntil IndInpos(Station_A,1) = TRUE;  
WaitTime 0.2;  
IndAMove Station_A,1\ToAbsNum:=10,20;
```

Axis 1 of `Station_A` is moved to the following positions:

- 90 degrees
- 440 degrees (1 revolution + 80 degrees)
- 410 degrees (1 revolution + 50 degrees)

Continues on next page

- 510 degrees (1 revolution + 150 degrees)
- 10 degrees

Limitations

Axes in independent mode cannot be jogged. If an attempt is made to execute the axis manually the axis will not move, and an error message will be displayed.

Execute an `IndReset` instruction or move the program pointer to main to leave independent mode.

If a power fail occurs when the axis is in independent mode the program cannot be restarted. An error message is displayed, and the program must be started from the beginning.

The instruction is not advisable for coupled robot wrist axes (see *RAPID reference manual- RAPID overview*, section *Motion and I/O principles - Positioning during program execution- Independent axes*).

Syntax

```
IndRMove
[MecUnit ':=' ] <variable (VAR) of mecunit> ','
[Axis ':=' ] <expression (IN) of num>
['\ ' ToRelPos ':=' <expression (IN) of robtargets>]
| ['\ ' ToRelNum ':=' <expression (IN) of num>]
['\ ' Short] | ['\ ' Fwd] | ['\ ' Bwd] ','
[Speed ':=' ] <expression (IN) of num>
['\ ' Ramp ':=' <expression (IN) of num>'];'
```

Related information

For information about	See
Independent axes in general	<i>Technical reference manual - RAPID Overview</i>
<i>Independent Axis</i>	<i>Application manual - Controller software IRC5</i>
Change back to normal mode	IndReset - Independent reset on page 273
Reset the measurement system	IndReset - Independent reset on page 273
Other independent axis movement	IndAMove - Independent absolute position movement on page 262 IndDMove - Independent delta position movement on page 270 IndCMove - Independent continuous movement on page 266
Check the speed status for independent axes	IndSpeed - Independent speed status on page 1332
Check the position status for independent axes	IndInpos - Independent axis in position status on page 1330
Activating independent joints	<i>Technical reference manual - System parameters</i> , topic <i>Motion</i> , type <i>Arm</i>

1 Instructions

1.107 InitSuperv - Reset all supervision for CAP *Continuous Application Platform (CAP)*

1.107 InitSuperv - Reset all supervision for CAP

Usage

`InitSuperv` is used to initiate CAP supervision. This means that all supervision lists will be cleared and all I/O subscriptions will be removed.

Example

```
PROC main()  
  InitSuperv;  
  SetupSuperv diWR_EST, ACT,SUPERV_MAIN;  
  SetupSuperv diGA_EST, ACT,SUPERV_MAIN;  
  CapL p2, v100, cdata1, weavestart, weave,fine, tWeldGun;  
ENDPROC
```

`InitSuperv` is used to clear all supervision lists before setting up new supervision.

Limitations

The `InitSuperv` instruction should be executed only once, for example, from the startup shelf.

Syntax

```
InitSuperv ';' 
```

Related information

For information about	See
<i>Continuous Application Platform</i>	<i>Application manual - Continuous Application Platform</i>
SetupSuperv instruction	SetupSuperv - Setup conditions for signal supervision in CAP on page 718
RemoveSuperv instruction	RemoveSuperv - Remove condition for one signal on page 605

1.108 InvertDO - Inverts the value of a digital output signal

Usage

`InvertDO` (*Invert Digital Output*) inverts the value of a digital output signal (0 -> 1 and 1 -> 0).

Basic examples

The following example illustrates the instruction `InvertDO`:

Example 1

```
InvertDO do15;
```

The current value of the signal `do15` is inverted.

Arguments

`InvertDO` Signal

Signal

Data type: `signaldo`

The name of the signal to be inverted.

Program execution

The current value of the signal is inverted (see figure below).

The figure below shows inversion of digital output signal.

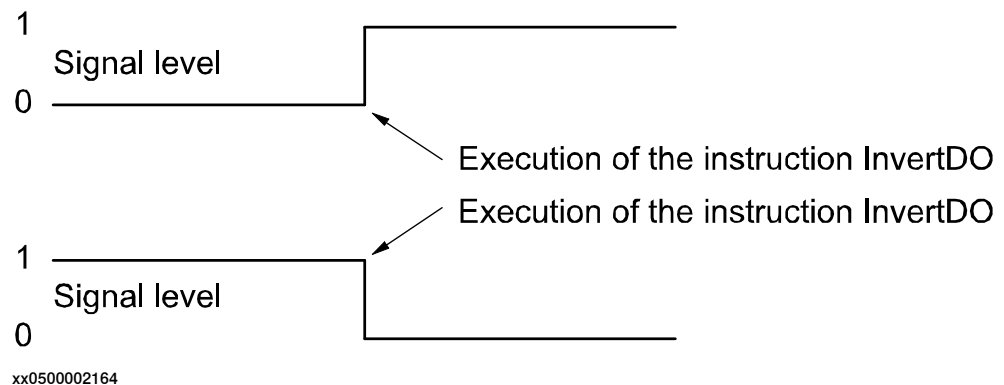

Error handling

The following recoverable errors can be generated. The errors can be handled in an `ERROR` handler. The system variable `ERRNO` will be set to:

Name	Cause of error
<code>ERR_NO_ALIASIO_DEF</code>	The signal variable is a variable declared in RAPID. It has not been connected to an I/O signal defined in the I/O configuration with instruction <code>AliasIO</code> .
<code>ERR_NORUNUNIT</code>	There is no contact with the I/O device.
<code>ERR_SIG_NOT_VALID</code>	The I/O signal cannot be accessed (only valid for ICI field bus).

Continues on next page

1 Instructions

1.108 InvertDO - Inverts the value of a digital output signal

RobotWare Base

Continued

Syntax

```
InvertDO  
  [Signal '[:='] <variable (VAR) of signaldo>'];'
```

Related information

For information about	See
Input/Output instructions	<i>Technical reference manual - RAPID Overview</i>
Input/Output functionality in general	<i>Technical reference manual - RAPID Overview</i>
Configuration of I/O	<i>Technical reference manual - System parameters</i>

1.109 IOBusStart - Start of I/O network

Usage

`IOBusStart` is used to start a certain I/O network.

Basic examples

The following example illustrates the instruction `IOBusStart`:

Example 1

```
IOBusStart "IBS";
```

The instruction start the I/O network with the name `IBS`.

Arguments

```
IOBusStart BusName
```

BusName

Data type: `string`

The name of I/O network to start.

Program execution

Start the I/O network with the name specified in the parameter `BusName`.

Error handling

The following recoverable errors can be generated. The errors can be handled in an ERROR handler. The system variable `ERRNO` will be set to:

Name	Cause of error
<code>ERR_NAME_INVALID</code>	The I/O network name does not exist.

Syntax

```
IOBusStart  
[ BusName ':= ' ] < expression (IN) of string>;'
```

Related information

For information about	See
How to get I/O network state	IOBusState - Get current state of I/O network on page 286
Configuration of I/O	<i>Technical reference manual - System parameters</i>

1 Instructions

1.110 IOBusState - Get current state of I/O network

RobotWare Base

1.110 IOBusState - Get current state of I/O network

Usage

`IOBusState` is used to read the state of a certain I/O network. Its physical state and logical state define the status for an I/O network.

Basic examples

The following examples illustrate the instruction `IOBusState`:

Example 1

```
VAR busstate bstate;

IOBusState "IBS", bstate \Phys;
TEST bstate
CASE IOBUS_PHYS_STATE_RUNNING:
    ! Possible to access the signals on the IBS bus
DEFAULT:
    ! Actions for not up and running IBS bus
ENDTEST
```

The instruction returns the physical I/O network state of IBS in the `bstate` variable of type `busstate`.

Example 2

```
VAR busstate bstate;

IOBusState "IBS", bstate \Logic;
TEST bstate
CASE IOBUS_LOG_STATE_STARTED:
    ! The IBS bus is started
DEFAULT:
    ! Actions for stopped IBS bus
ENDTEST
```

The instruction returns the logical I/O network state of IBS in the `bstate` variable of type `busstate`.

Arguments

```
IOBusState BusName State [\Phys] | [\Logic]
```

BusName

Data type: string

The name of I/O network to get state about.

State

Data type: busstate

The variable in which the I/O network state is returned. See predefined data of type `busstate` below at Program execution.

[\Phys]

Physical

Continues on next page

Data type: `switch`

If using this parameter the physical state of the I/O network is read.

`[\Logic]`

Logical

Data type: `switch`

If using this parameter the logical state of the I/O network is read.

Program execution

Returning in parameter `State` the state of the I/O network that is specified in parameter `BusName`.

The I/O network logical states describe the state a user can order the bus into. The state of the I/O network is defined in the table below when using optional argument `\Logic`.

Return value	Symbolic constant	Comment
10	IOBUS_LOG_STATE_STOPPED	Bus is stopped due to error ²⁾
11	IOBUS_LOG_STATE_STARTED	Bus is started ¹⁾

The I/O network physical state describes the state that the fieldbus driver can order the bus into. The state of the I/O network is defined in the table below when using optional argument `\Phys`.

Return value	Symbolic constant	Comment
20	IOBUS_PHYS_STATE_HALTED	Bus is halted ³⁾
21	IOBUS_PHYS_STATE_RUNNING	Bus is up and running ¹⁾
22	IOBUS_PHYS_STATE_ERROR	Bus is not working ²⁾
23	IOBUS_PHYS_STATE_STARTUP	Bus is in start up mode, is not communicating with any I/O devices.
24	IOBUS_PHYS_STATE_INIT	Bus is only created ³⁾



Note

The state of the I/O network is defined in the table below when not using any of the optional arguments `\Phys` or `\Logic`.

Return value	Symbolic constant	Comment
0	BUSSTATE_HALTED	Bus is halted ³⁾
1	BUSSTATE_RUN	Bus is up and running ¹⁾
2	BUSSTATE_ERROR	Bus is not working ²⁾
3	BUSSTATE_STARTUP	Bus is in start up mode, is not communicating with any I/O devices.
4	BUSSTATE_INIT	Bus is only created ³⁾

¹⁾ If the I/O network is up and running the state returned in argument `State` in instruction `IOBusState` can be either `IOBUS_LOG_STATE_STARTED`,

Continues on next page

1 Instructions

1.110 IOBusState - Get current state of I/O network

RobotWare Base

Continued

IOBUS_PHYS_STATE_RUNNING, or BUSSTATE_RUN depending on if optional parameters are used or not in IOBusState.

2) If the I/O network is stopped due to some error the state returned in argument State can be either IOBUS_LOG_STATE_STOPPED, IOBUS_PHYS_STATE_ERROR, or BUSSTATE_ERROR depending on if optional parameters are used or not in IOBusState.

3) Not possible to get this state in the RAPID program with current version of Robotware - OS.

Error handling

The following recoverable errors can be generated. The errors can be handled in an ERROR handler. The system variable ERRNO will be set to:

Name	Cause of error
ERR_NAME_INVALID	The I/O network name does not exist.

Syntax

```
IOBusState
  [ BusName ':= ' ] < expression (IN) of string> ', '
  [ State ':= ' ] < variable (VAR) of busstate>
  [ '\ ' Phys ] | [ '\ ' Logic ] ';'

```

Related information

For information about	See
Definition of I/O network state	busstate - State of I/O network on page 1603
Start of I/O network	IOBusStart - Start of I/O network on page 285
Input/Output functionality in general	<i>Technical reference manual - RAPID Overview</i>
Configuration of I/O	<i>Technical reference manual - System parameters</i>

1.111 IODisable - Deactivate an I/O device

Usage

`IODisable` is used to deactivate an I/O device during program execution.

I/O devices are automatically activated after start-up if they are defined in the system parameters. When required for some reason, I/O devices can be deactivated or activated during program execution.



Note

It is not possible to deactivate an I/O device with Unit Trustlevel set to Required.

Basic examples

The following example illustrates the instruction `IODisable`:

See also [More examples on page 290](#).

Example 1

```
CONST string board1:="board1";  
IODisable board1, 5;
```

Deactivate an I/O device with name `board1`. Wait maximum 5 seconds.

Arguments

```
IODisable UnitName MaxTime
```

UnitName

Data type: string

A name of an I/O device (the device name must be present in the system parameters).

MaxTime

Data type: num

The maximum period of waiting time permitted expressed in seconds. If this time runs out before the I/O device has finished the deactivation steps the error handler will be called, if there is one, with the error code `ERR_IODISABLE`. If there is no error handler the program execution will be stopped. The I/O device deactivation steps will always continue regardless of the `MaxTime` or error.

To deactivate an I/O device takes about 0-5 s.

Program execution

The specified I/O device starts the deactivation steps. The instruction is ready when the deactivation steps are finished. If the `MaxTime` runs out before the I/O device has finished the deactivation steps, a recoverable error will be generated.

After deactivation of an I/O device, any setting of outputs on this unit will result in an error.

Continues on next page

1 Instructions

1.111 IODisable - Deactivate an I/O device

RobotWare Base

Continued

Error handling

The following recoverable errors can be generated. The errors can be handled in an ERROR handler. The system variable `ERRNO` will be set to:

Name	Cause of error
<code>ERR_IODISABLE</code>	The waiting time expires before the I/O device is deactivated.
<code>ERR_NAME_INVALID</code>	The I/O device name does not exist.
<code>ERR_TRUSTLEVEL</code>	The I/O device cannot be deactivated if the Unit Trustlevel is set to Required.

More examples

More examples of the instruction `IODisable` are illustrated below.

Example 1

```
PROC go_home()
  VAR num recover_flag :=0;
  ...
  ! Start to deactivate I/O unit board1
  recover_flag := 1;
  IODisable "board1", 0;
  ! Move to home position
  MoveJ home, v1000,fine,tool1;
  ! Wait until deactivation of I/O unit board1 is ready
  recover_flag := 2;
  IODisable "board1", 5;
  ...
  ERROR
  IF ERRNO = ERR_IODISABLE THEN
    IF recover_flag = 1 THEN
      TRYNEXT;
    ELSEIF recover_flag = 2 THEN
      IF RemaningRetries() > 0 THEN
        RETRY;
      ELSE
        RAISE;
      ENDIF
    ENDIF
  ELSE
    ErrWrite "IODisable error", "Not possible to deactivate I/O
      unit board1";
    Stop;
  ENDIF
ENDPROC
```

To save cycle time the I/O device `board1` is deactivated during robot movement to the home position. With the robot at the home position a test is done to establish whether or not the I/O device `board1` is fully deactivated. After the max. number of retries (4 with a waiting time of 5 s), the robot execution will stop with an error message.

Continues on next page

The same principle can be used with IOEnable (this will save more cycle time compared with IODisable).

Syntax

```
IODisable
  [ UnitName ':=' ] < expression (IN) of string> ','
  [ MaxTime ':=' ] < expression (IN) of num> ';'

```

Related information

For information about	See
Activating an I/O device	IOEnable - Activate an I/O device on page 292
Input/Output instructions	<i>Technical reference manual - RAPID Overview</i>
Input/Output function in general	<i>Technical reference manual - RAPID Overview</i>
Configuration of I/O	<i>Technical reference manual - System parameters</i>

1 Instructions

1.112 IOEnable - Activate an I/O device

RobotWare Base

1.112 IOEnable - Activate an I/O device

Usage

`IOEnable` is used to activate an I/O device during program execution.

I/O devices are automatically activated after start-up if they are defined in the system parameters. When required for some reason I/O devices can be deactivated or activated during program execution.

The controller action when activating an I/O device depends on the defined Unit Trustlevel in the system parameters.

Basic examples

The following example illustrates the instruction `IOEnable`:

See also [More examples on page 293](#).

Example 1

```
CONST string board1:="board1";  
IOEnable board1, 5;
```

Activate an I/O device with name `board1`. Wait max. 5 s.

Arguments

```
IOEnable UnitName MaxTime
```

UnitName

Data type: string

A name of an I/O device (the I/O device name must be present in the system parameters).

MaxTime

Data type: num

The maximum period of waiting time permitted, expressed in seconds. If this time runs out before the I/O device has finished the activation steps the error handler will be called, if there is one, with the error code `ERR_IOENABLE`. If there is no error handler the execution will be stopped. The I/O device activation steps will always continue regardless of `MaxTime` or error.

To activate an I/O device takes about 2-5 s.

Program execution

The specified I/O device starts the activation steps. The instruction is ready when the activation steps are finished. If the `MaxTime` runs out before the I/O device has finished the activation steps a recoverable error will be generated.

After a sequence of `IODisable - IOEnable`, all outputs on the current I/O device will be set to the old values (before `IODisable`).

Continues on next page

Error handling

The following recoverable errors can be generated. The errors can be handled in an ERROR handler. The system variable `ERRNO` will be set to:

Name	Cause of error
ERR_IOENABLE	The time out time runs out before the I/O device is activated.
ERR_NAME_INVALID	The I/O device name does not exist
ERR_BUSSTATE	The I/O network is in error state or enters error state before the I/O device is activated.

More examples

`IOEnable` can also be used to check whether some I/O device is disconnected for some reason.

More examples of how to use the instruction `IOEnable` are illustrated below.

Example 1

```

VAR num max_retry:=0;
...
IOEnable "board1", 0;
SetDO board1_sig3, 1;
...
ERROR
  IF ERRNO = ERR_IOENABLE THEN
    IF RemaningRetries() > 0 THEN
      WaitTime 1;
      RETRY;
    ELSE
      RAISE;
    ENDIF
  ELSE
    ErrWrite "IOEnable error", "Not possible to activate I/O unit
      board1";
    Stop;
  ENDIF

```

Before using signals on the I/O device `board1`, a test is done by trying to activate the I/O device with time-out after 0 sec. If the test fails a jump is made to the error handler. In the error handler the program execution waits for 1 sec. and a new retry is made. After 4 retry attempts the error `ERR_IOENABLE` is propagated to the caller of this routine.

Syntax

```

IOEnable
  [ UnitName ':' ] < expression (IN) of string> ' , '
  [ MaxTime ':' ] < expression (IN) of num > ' ; '

```

Related information

For information about	See
Deactivating an I/O device	IODisable - Deactivate an I/O device on page 289

Continues on next page

1 Instructions

1.112 IOEnable - Activate an I/O device

RobotWare Base

Continued

For information about	See
Input/Output instructions	<i>Technical reference manual - RAPID Overview</i>
Input/Output functionality in general	<i>Technical reference manual - RAPID Overview</i>
Configuration of I/O	<i>Technical reference manual - System parameters</i>

1.113 IOEventMessage - Turn on/off I/O event messages from device

Usage

IOEventMessage is used to define if I/O event messages should be sent from the I/O device.

This can typically be used for a planned power cycle or disconnection of the I/O device, for example during tool change with FastDeviceStartup. For more information regarding FastDeviceStartup, see *Application manual - PROFINET Controller/Device*.

Basic examples

The following example illustrates the instruction IOEventMessage:

Example

```
PROC IOEventMessage(switch \On | switch \Off, string DeviceName);
```

Arguments

```
IOEventMessage [\On] | [\Off] DeviceName
```

[\On]

Data type: switch

Activate the I/O event messages from the device.

[\Off]

Data type: switch

Deactivate the I/O event messages from the device.

Program execution

```
PERS string TC_IO := "ToolChanger_IO"
! I/O Device name

PROC setTool(num Tool)
! We will now switch tool and thus shut down the current active
! tool, we stop event logs while performing toolchange
IOEventMessage \Off, TC_IO;
! Stop Event Messages

IF (tool = 1) THEN
SetDO Tool2_PS, 0;
! shut down Power supply Tool 2
WaitDi Tool_Active, 0\MaxTime:=1;
! wait for device to shut down

SetDO Tool1_PS, 1;
! power up Tool 1
WaitDi Tool_Active, 1\MaxTime:=1;
! wait for device to activate

! Check device is up and running OK
```

Continues on next page

1 Instructions

1.113 IOErrorMessage - Turn on/off I/O event messages from device

RobotWare Base

Continued

```
IF (IOUnitState (TC_IO) = IOUNIT_RUNERROR) THEN
  Log "ERROR: Unit is not working because of some runtime
      error.";

ELSEIF (IOUnitState (TC_IO) = IOUNIT_OTHERERR) THEN
  Log "ERROR: Other configuration or startup errors.";
ENDIF

IF (tool = 2) THEN
  !Same as above but for tool 2

  ! Toolchange finished, now we want event logs active again
  IOErrorMessage \On, TC_IO;
  ! Turn Event Messages

ENDPROC
```

Error handling

The following recoverable errors can be generated. The errors can be handled in an ERROR handler. The system variable ERRNO will be set to:

Name	Cause of error
ERR_NAME_INVALID	The I/O device name does not exist

Syntax

```
IOErrorMessage
[ '\ On ] | [ '\ Off ]
[ DeviceName ' := ' ] < expression (IN) of string > ';' 
```

Related information

For information about	See
Fast Device Startup	<i>Application manual - PROFINET Controller/Device</i>

1.114 IPathPos - Get center line robtarget when weaving

Usage

IPathPos is used to retrieve the position of the center line during weaving with CAP.

This function is mainly used together with the tracking functionality. It is necessary to activate weaving and the synchronization signals on both the left side and the right side.

Basic example

```
connect intpt, TRP_ipathpos IPathPos p_robtarget, sen_pos, intpt;
```

When `p_robtarget` gets a new calculated value, the interrupt `intpt` will be sent, and the trap routine `TRP_ipathpos` will be executed.

Arguments

```
IPathPos p_robtarget, sen_pos, intpt [\NoDispl] [\EOffs]
```

p_robtarget

Data type: robtarget

`p_robtarget` keeps the latest value of the calculated robtarget.

sen_pos

Data type: pos

`sen_pos` is not used.

intpt

Data type: intno

`intpt` specifies the interrupt that will be received each time a new value is assigned to `p_robtarget`.

[\NoDispl]

Data type: switch

If `\NoDispl` is specified, the value returned in the PERS `p_robtarget` will not include any displacement that might be specified using the RAPID instructions `PDispSet` and `PDispOn`.

[\EOffs]

Data type: switch

If `[\EOffs]` is specified, the value returned in the PERS `p_robtarget` will include any offset specified using the RAPID instruction `EOffsSet`.

Limitations

It is necessary to activate weaving and weave synchronization (with or without tracking).

Syntax

```
IPathPos  
[p_robtarget ':='] < persistent (PERS) of robtarget > ', '
```

Continues on next page

1 Instructions

1.114 IPathPos - Get center line robtarget when weaving

Continuous Application Platform (CAP)

Continued

```
[sen_pos ':='] < persistent (PERS) of pos > ','  
[Interrupt ':='] < variable (IN) of intnum >  
['\ ' EOffs ]  
['\ ' NoDispl ] ';' 
```

Related information

For information about	See
<i>Continuous Application Platform</i>	<i>Application manual - Continuous Application Platform</i>
CapWeaveSync instruction	CapWeaveSync - set up signals and levels for weave synchronization on page 127
CapAPTrSetup instruction	CapAPTrSetup - Set up an At-Point-Tracker on page 80
CapLATrSetup instruction	CapLATrSetup - Set up a Look-Ahead-Tracker on page 117

1.115 IPers - Interrupt at value change of a persistent variable

Usage

`IPers` (*Interrupt Persistent*) is used to order and enable interrupts to be generated when the value of a persistent variable is changed.

Basic examples

The following examples illustrates the instruction `IPers`:

Example 1

```
VAR intnum perslint;
PERS num counter := 0;

PROC main()
  CONNECT perslint WITH iroutine1;
  IPers counter, perslint;
  ...
  IDelete perslint;
ENDPROC

TRAP iroutine1
  TPWrite "Current value of counter = " \Num:=counter;
ENDTRAP
```

Orders an interrupt which is to occur each time the persistent variable `counter` is changed. A call is then made to the `iroutine1` trap routine.

Arguments

`IPers [\Single] | [\SingleSafe] Name Interrupt`

[\Single]

Data type: switch

Specifies whether the interrupt is to occur once or cyclically.

If the argument `Single` is set, the interrupt occurs once at the most. If the `Single` and `SingleSafe` arguments is omitted, an interrupt will occur each time its condition is satisfied.

[\SingleSafe]

Data type: switch

Specifies that the interrupt is single and safe. For definition of single, see description of `Single` argument. A safe interrupt cannot be put in sleep with instruction `ISleep`. The safe interrupt event will be queued at program stop and stepwise execution, and when starting in continuous mode again, the interrupt will be executed. The only time a safe interrupt will be thrown is when the interrupt queue is full. Then an error will be reported. The interrupt will not survive program reset, e.g. PP to main.

Name

Data type: anytype

Continues on next page

1 Instructions

1.115 IPers - Interrupt at value change of a persistent variable

RobotWare Base

Continued

The persistent variable that is to generate interrupts.

All type of data could be used such as atomic, record, record component, array, or array element.

Interrupt

Data type: `intnum`

The interrupt identity. This should have previously been connected to a trap routine by means of the instruction `CONNECT`.

Program execution

When the persistent variable changes value a call is made to the corresponding trap routine. When this routine has been executed program execution continues from where the interrupt occurred.

If the persistent variable changes value during a program stop no interrupt will occur when the program starts again.

Limitations

The same variable for interrupt identity cannot be used more than once without first deleting it. See Instructions - `ISignalDI`.

If subscribed on data such as record component or array element specified in parameter `Name`, the interrupt will occur every time any part of the data is changed.

When executing the trap routine and reading the value of the persistent, there is no guarantee that the value read is the one that triggered the interrupt.

Syntax

```
IPers
  [ '\ ' Single ] | [ '\ ' SingleSafe ] ','
  [ Name ':=' ] < persistent (PERS) of anytype > ','
  [ Interrupt' ':=' ] < variable (VAR) of intnum > ';'

```

Related information

For information about	See
Summary of interrupts and interrupt management	<i>Technical reference manual - RAPID Overview</i>
Interrupt from an input signal	ISignalDI - Orders interrupts from a digital input signal on page 319
Interrupt identity	intnum - Interrupt identity on page 1675
<i>Advanced RAPID</i>	<i>Application manual - Controller software IRC5</i>

1.116 IRMQMessage - Orders RMQ interrupts for a data type *FlexPendant Interface, PC Interface, or Multitasking*

1.116 IRMQMessage - Orders RMQ interrupts for a data type

Usage

`IRMQMessage` (*Interrupt RAPID Message Queue Message*) is used to order and enable interrupts for a specific data type when using RMQ function.

Basic examples

The following example illustrates the instruction `IRMQMessage`:

See also [IRMQMessage - Orders RMQ interrupts for a data type on page 301](#).

Example 1

```
VAR intnum rmqint;
VAR string dummy;
...
PROC main()
  CONNECT rmqint WITH iroutine1;
  IRMQMessage dummy, rmqint;
```

Orders an interrupt which is to occur each time a new `rmqmessage` containing the data type `string` is received. A call is then made to the trap routine `iroutine1`.

Arguments

`IRMQMessage InterruptDataType Interrupt`

InterruptDataType

Data type: anytype

A reference to a variable, persistent or constant of a data type that will generate an interrupt when a `rmqmessage` with the specified data type is received.

Interrupt

Data type: intnum

The interrupt identity. This should have previously been connected to a trap routine by the instruction `CONNECT`.

Program execution

When the RMQ message with the specified data type is received, a call is made to the corresponding trap routine. When this has been executed, program execution continues from where the interrupt occurred.

All messages containing data of the same data type regardless of number of dimensions will be handled by the same interrupt. If using different dimensions, use `RMQGetMsgHeader` to adapt for this.

Any message containing data of a data type that no interrupt is connected to, will generate a warning.

The `RMQSendWait` instruction has the highest priority if a message is received and it fits the description for both the expected answer and a message connected to a trap routine with instruction `IRMQMessage`.

Not all data types can be used in argument `InterruptDataType` (see limitations).

Continues on next page

1 Instructions

1.116 IRMQMessage - Orders RMQ interrupts for a data type

FlexPendant Interface, PC Interface, or Multitasking

Continued

The interrupt is considered to be a safe interrupt. A safe interrupt cannot be put in sleep with instruction `ISleep`. The safe interrupt event will be queued at program stop and stepwise execution, and when starting in continuous mode again, the interrupt will be executed. The only time a safe interrupt will be thrown is when the interrupt queue is full. Then an error will be reported. The interrupt will not survive program reset, e.g. PP to main.

More examples

More examples of how to use the instruction `IRMQMessage` are illustrated below.

Example 1

```
MODULE ReceiverMod
  VAR intnum intno1;
  VAR rmqheader rmqheader1;
  VAR rmqslot rmqslot1;
  VAR rmqmessage rmqmessage1;

  PROC main()
    VAR string interrupt_on_str := stEmpty;
    CONNECT intno1 WITH RecMsgs;
    ! Set up interrupts for data type string
    IRMQMessage interrupt_on_str, intno1;

    ! Perform cycle
    WHILE TRUE DO
      ...
    ENDWHILE
  ENDPROC
  TRAP RecMsgs
  VAR string receivestr;
  VAR string client_name;
  VAR num userdef;

  ! Get the message from the RMQ
  RMQGetMessage rmqmessage1;
  ! Get information about the message
  RMQGetMsgHeader rmqmessage1 \Header:=rmqheader1
    \SenderId:=rmqslot1 \UserDef:=userdef;

  IF rmqheader1.datatype = "string" AND rmqheader1.ndim = 0 THEN
    ! Get the data received in rmqmessage1
    RMQGetMsgData rmqmessage1, receivestr;
    client_name := RMQGetSlotName(rmqslot1);
    TPWrite "Rec string: " + receivestr;
    TPWrite "User Def: " + ValToStr(userdef);
    TPWrite "From: " + client_name;
  ELSE
    TPWrite "Faulty data received!"
  ENDIF
END
```

Continues on next page

1.116 IRMQMessage - Orders RMQ interrupts for a data type *FlexPendant Interface, PC Interface, or Multitasking* Continued

```
ENDTRAP
ENDMODULE
```

The example show how to set up interrupts for a specific data type. When a message is received, the trap routine `RecMsgs` is executed and the received data in the message is sent to the FlexPendant. If the data type received or the dimension of the data is different from the expected, this is sent to the FlexPendant.

Limitations

It is not allowed to execute `IRMQMessage` in synchronous mode. That will cause a fatal runtime error.

It is not possible to setup interrupts, send or receive data instances of data types that are of non-value, semi-value types, or data type `motsetdata`.

The same variable for interrupt identity cannot be used more than once without first deleting it. Interrupts should therefore be handled as shown in one of the alternatives below.

```
VAR intnum rmqint;
PROC main ( )
  VAR mytype dummy;
  CONNECT rmqlint WITH iroutinel;
  IRMQMessage dummy, rmqint;
  WHILE TRUE DO
    ...
  ENDWHILE
ENDPROC
```

All activation of interrupts is done at the beginning of the program. These beginning instructions are then kept outside the main flow of the program.

```
VAR intnum rmqint;
PROC main ( )
  VAR mytype dummy;
  CONNECT rmqint WITH iroutinel;
  IRMQMessage dummy, rmqint;
  ...
  IDelete rmqint;
ENDPROC
```

The interrupt is deleted at the end of the program, and is then reactivated. Note, in this case, the interrupt is inactive for a short period.

Syntax

```
IRMQMessage
[ InterruptDataType ':= ' ] < reference (REF) of anytype >
[ Interrupt ':= ' ] < variable (VAR) of intnum >;'
```

Related information

For information about	See
Description of the RAPID Message Queue functionality	<i>Application manual - Controller software IRC5</i>
Send data to the queue of a RAPID task or Robot Application Builder client.	RMQFindSlot - Find a slot identity from the slot name on page 626

Continues on next page

1 Instructions

1.116 IRMQMessage - Orders RMQ interrupts for a data type

FlexPendant Interface, PC Interface, or Multitasking

Continued

For information about	See
Get the first message from a RAPID Message Queue.	RMQGetMessage - Get an RMQ message on page 628
Send data to the queue of a RAPID task or Robot Application Builder client, and wait for an answer from the client.	RMQSendWait - Send an RMQ data message and wait for a response on page 644
Extract the header data from a <code>rmqmessage</code> .	RMQGetMsgHeader - Get header information from an RMQ message on page 634
Send data to the queue of a RAPID task or Robot Application Builder client.	RMQSendMessage - Send an RMQ data message on page 640
Extract the data from a <code>rmqmessage</code> .	RMQGetMsgData - Get the data part from an RMQ message on page 631
Get the slot name from a specified slot identity.	RMQGetSlotName - Get the name of an RMQ client on page 1445

1.117 ISignalAI - Interrupts from analog input signal

Usage

ISignalAI (*Interrupt Signal Analog Input*) is used to order and enable interrupts from an analog input signal.

Basic examples

The following examples illustrate the instruction ISignalAI:

Example 1

```
VAR intnum siglint;
PROC main()
  CONNECT siglint WITH iroutine1;
  ISignalAI \Single, ail, AIO_BETWEEN, 1.5, 0.5, 0, siglint;
```

Orders an interrupt which is to occur the first time the logical value of the analog input signal `ail` is between 0.5 and 1.5. A call is then made to the `iroutine1` trap routine.

Example 2

```
ISignalAI ail, AIO_BETWEEN, 1.5, 0.5, 0.1, siglint;
```

Orders an interrupt which is to occur each time the logical value of the analog input signal `ail` is between 0.5 and 1.5, and the absolute signal difference compared to the stored reference value is bigger than 0.1.

Example 3

```
ISignalAI ail, AIO_OUTSIDE, 1.5, 0.5, 0.1, siglint;
```

Orders an interrupt which is to occur each time the logical value of the analog input signal `ail` is lower than 0.5 or higher than 1.5, and the absolute signal difference compared to the stored reference value is bigger than 0.1.

Arguments

```
ISignalAI [\Single] | [\SingleSafe] Signal Condition HighValue
          LowValue DeltaValue [\DPos] | [\DNeg] Interrupt
```

`[\Single]`

Data type: `switch`

Specifies whether the interrupt is to occur once or cyclically. If the argument `Single` is set, the interrupt occurs once at the most. If the `Single` and `SingleSafe` arguments is omitted, an interrupt will occur each time its condition is satisfied.

`[\SingleSafe]`

Data type: `switch`

Specifies that the interrupt is single and safe. For definition of `single`, see description of `Single` argument. A safe interrupt cannot be put in sleep with instruction `ISleep`. The safe interrupt event will be queued at program stop and stepwise execution, and when starting in continuous mode again, the interrupt will be executed. The only time a safe interrupt will be thrown is when the interrupt queue is full. Then an error will be reported. The interrupt will not survive program reset, e.g. PP to main.

Continues on next page

1 Instructions

1.117 ISignalAI - Interrupts from analog input signal

RobotWare Base

Continued

Signal

Data type: `signalai`

The name of the signal that is to generate interrupts.

Condition

Data type: `aiotrigg`

Specifies how `HighValue` and `LowValue` define the condition to be satisfied:

Value	Symbolic constant	Comment
1	AIO_ABOVE_HIGH	Signal will generate interrupts if above specified high value
2	AIO_BELOW_HIGH	Signal will generate interrupts if below specified high value
3	AIO_ABOVE_LOW	Signal will generate interrupts if above specified low value
4	AIO_BELOW_LOW	Signal will generate interrupts if below specified low value
5	AIO_BETWEEN	Signal will generate interrupts if between specified low and high values
6	AIO_OUTSIDE	Signal will generate interrupts if below specified low value or above specified high value
7	AIO_ALWAYS	Signal will always generate interrupts

HighValue

Data type: `num`

High logical value to define the condition.

LowValue

Data type: `num`

Low logical value to define the condition.

DeltaValue

Data type: `num`

Defines the minimum logical signal difference before generation of a new interrupt. The current signal value compared to the stored reference value must be greater than the specified `DeltaValue` before generation of a new interrupt.

`[\DPos]`

Data type: `switch`

Specifies that only positive logical signal differences will give new interrupts.

`[\DNeg]`

Data type: `switch`

Specifies that only negative logical signal differences will give new interrupts.

If none of `\DPos` and `\DNeg` argument is used, both positive and negative differences will generate new interrupts.

Interrupt

Data type: `intnum`

The interrupt identity. This interrupt should have previously been connected to a trap routine by means of the instruction `CONNECT`.

Continues on next page

Program execution

When the signal fulfils the specified conditions (both `Condition` and `DeltaValue`) a call is made to the corresponding trap routine. When this has been executed, program execution continues from where the interrupt occurred.

Conditions for interrupt generation

Before the interrupt subscription is ordered, each time the signal is sampled, the value of the signal is read, saved, and later used as a reference value for the `DeltaValue` condition.

At the interrupt subscription time if specified `DeltaValue = 0` and after the interrupt subscription time, the signal is sampled. The signal value is then compared to `HighValue` and `LowValue` according to `Condition` and with consideration to `DeltaValue` to decide if an interrupt should be generated or not. If the new read value satisfies the specified `HighValue` and `LowValueCondition`, but its difference compared to the last stored reference value is less or equal to the `DeltaValue` argument, no interrupt occurs. If the signal difference is not in the specified direction no interrupts will occur (argument `\DPos` or `\DNeg`).

The stored reference value for the `DeltaValue` condition is updated with a newly read value for later use at any sample if the following conditions are satisfied:

- Argument `Condition` with specified `HighValue` and `LowValue` (within limits)
- Argument `DeltaValue` (sufficient signal change in any direction independently of specified switch `\DPos` or `\DNeg`)

The reference value is only updated at the sample time, not at the interrupt subscription time.

An interrupt is also generated at the sample for update of the reference value if the direction of the signal difference is in accordance with the specified argument (any direction, `\DPos0`, or `\DNeg`).

When the `\Single` switch is used only one interrupt at the most will be generated. If the switch `\Single` (cyclic interrupt) is not used a new test of the specified conditions (both `Condition` and `DeltaValue`) is made at every sample of the signal value. A comparison is made between the current signal value and the last stored reference value to decide if an interrupt should be generated or not.

Continues on next page

1 Instructions

1.117 ISignalAI - Interrupts from analog input signal

RobotWare Base

Continued

Condition for interrupt generation at interrupt subscription time

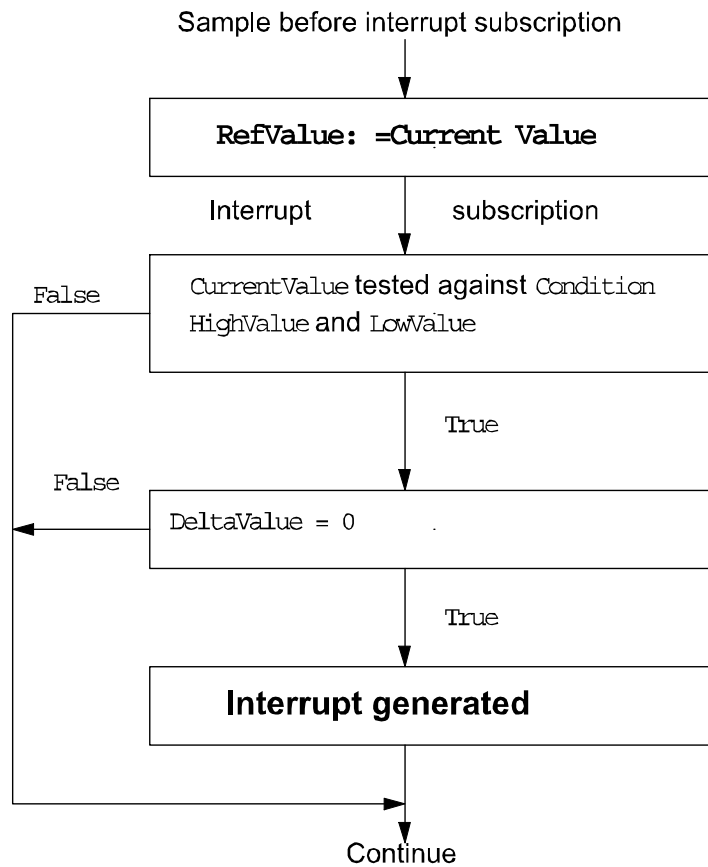

xx0500002165

Continues on next page

Condition for interrupt generation at each sample after interrupt subscription

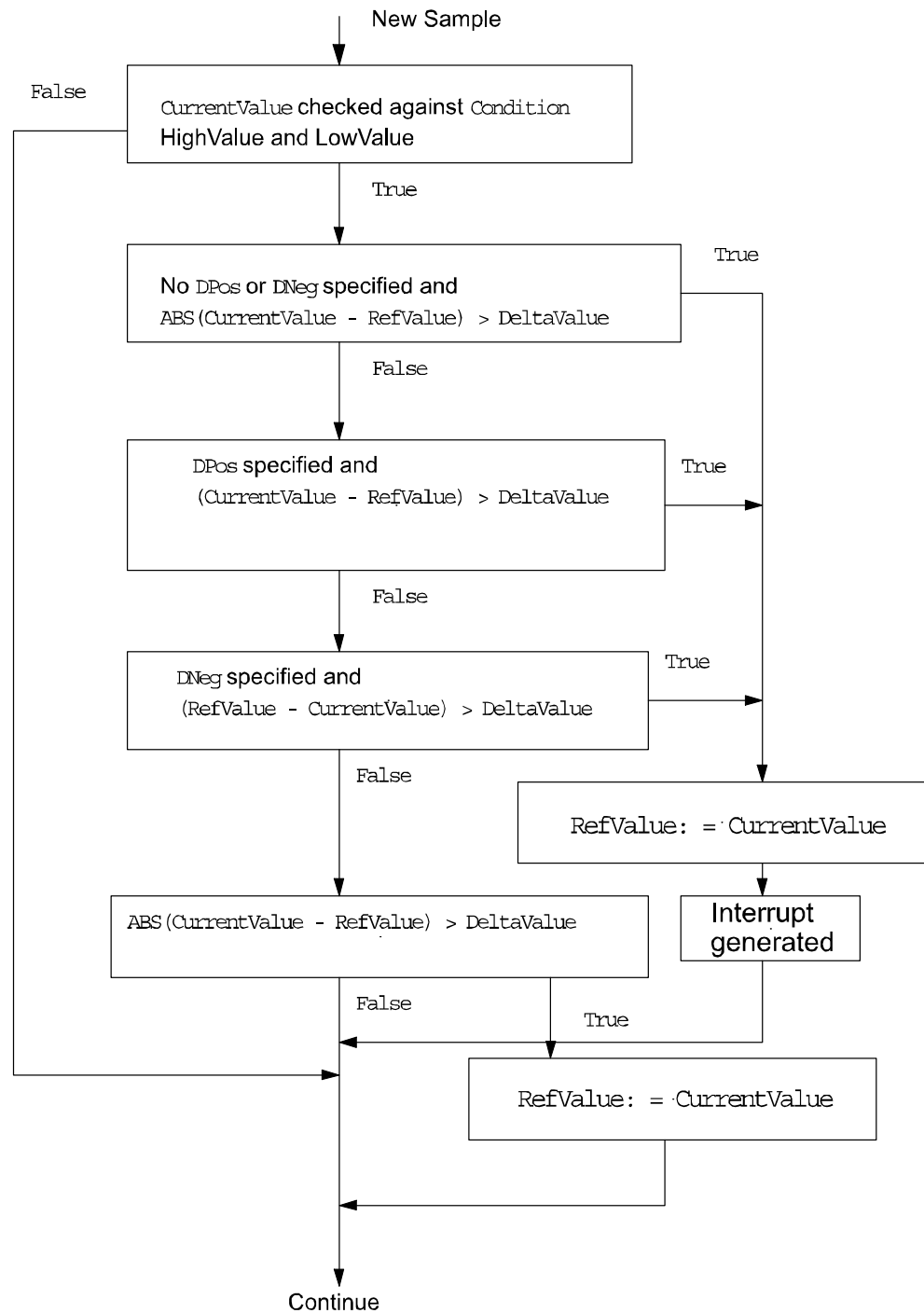

xx0500002166

Continues on next page

1 Instructions

1.117 ISignalAI - Interrupts from analog input signal

RobotWare Base

Continued

Example 1 of interrupt generation

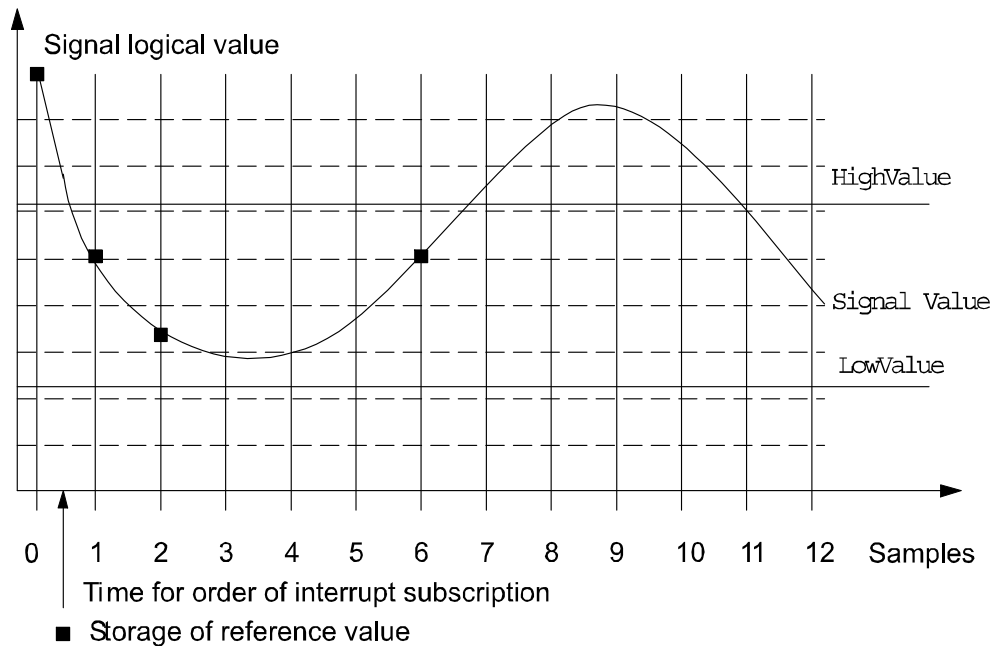

xx0500002167

Assuming the interrupt is ordered between sample 0 and 1, the following instruction will give the following results:

```
ISignalAI ai1, AIO_BETWEEN, 6.1, 2.2, 1.0, siglint;
```

Sample 1 will generate an interrupt because the signal value is between `HighValue` and `LowValue` and the signal difference compared to Sample 0 is more than `DeltaValue`.

Sample 2 will generate an interrupt because the signal value is between `HighValue` and `LowValue` and the signal difference compared to Sample 1 is more than `DeltaValue`.

Samples 3, 4, 5 will not generate any interrupt because the signal difference is less than `DeltaValue`.

Sample 6 will generate an interrupt.

Samples 7 to 10 will not generate any interrupt because the signal is above `HighValue`.

Sample 11 will not generate any interrupt because the signal difference compared to Sample 6 is equal to `DeltaValue`.

Sample 12 will not generate any interrupt because the signal difference compared to Sample 6 is less than `DeltaValue`.

Continues on next page

Example 2 of interrupt generation

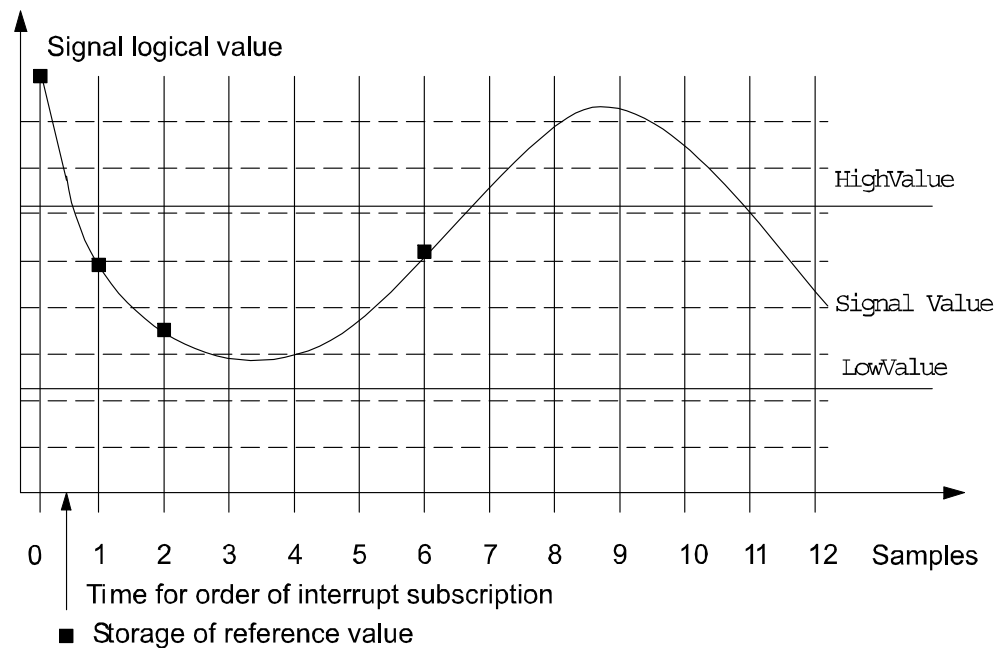

xx0500002168

Assuming the interrupt is ordered between sample 0 and 1, the following instruction will give the following results:

```
ISignalAI ai1, AIO_BETWEEN, 6.1, 2.2, 1.0 \DPos, siglint;
```

A new reference value is stored at sample 1 and 2 because the signal is within limits and the absolute signal difference between the current value and the last stored reference value is greater than 1.0. No interrupt will be generated because the signal changes are in the negative direction.

Sample 6 will generate an interrupt because the signal value is between `HighValue` and `LowValue`, and the signal difference in the positive direction compared to sample 2 is more than `DeltaValue`.

Continues on next page

1 Instructions

1.117 ISignalAI - Interrupts from analog input signal

RobotWare Base

Continued

Example 3 of interrupt generation

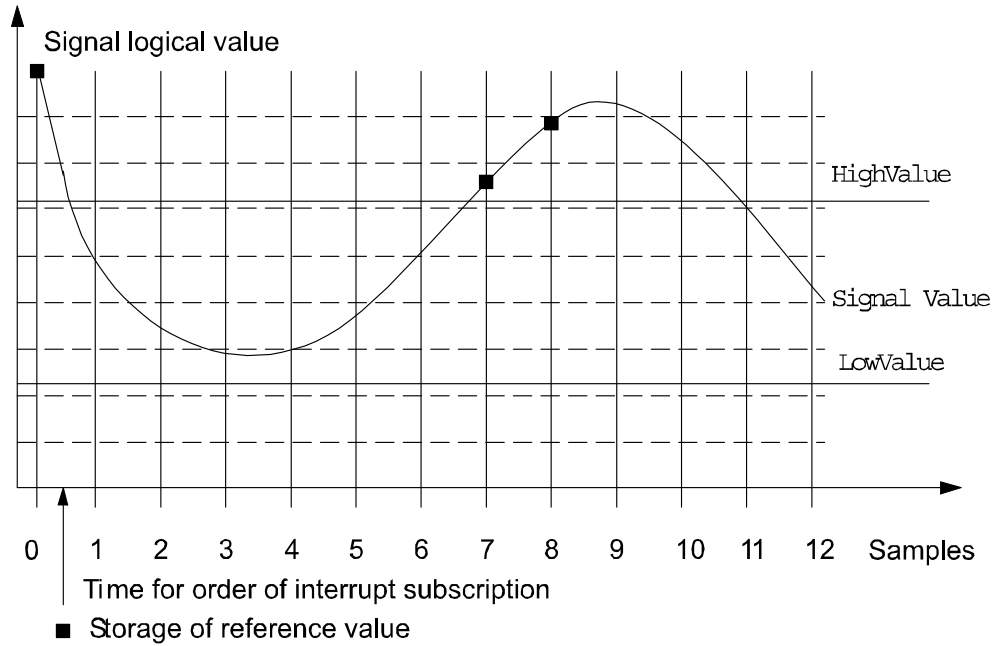

xx0500002169

Assuming the interrupt is ordered between sample 0 and 1, the following instruction will give the following results:

```
ISignalAI \Single, ai1, AIO_OUTSIDE, 6.1, 2.2, 1.0 \DPos, siglint;
```

A new reference value is stored at sample 7 because the signal is within limits and the absolute signal difference between the current value and the last stored reference value is greater than 1.0

sample 8 will generate an interrupt because the signal value is above HighValue, and the signal difference in the positive direction compared to sample 7 is more than DeltaValue.

Continues on next page

Example 4 of interrupt generation

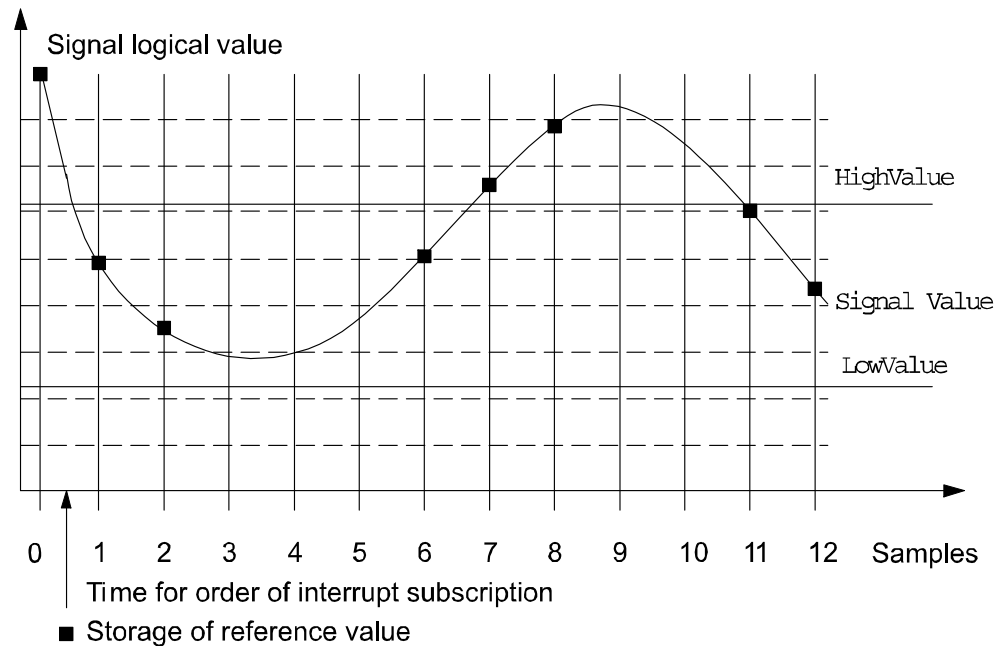

xx0500002170

Assuming the interrupt is ordered between sample 0 and 1, the following instruction will give the following results:

```
ISignalAI ai1, AIO_ALWAYS, 6.1, 2.2, 1.0 \DPos, siglint;
```

A new reference value is stored at sample 1 and 2 because the signal is within limits and the absolute signal difference between the current value and the last stored reference value is greater than 1.0

Sample 6 will generate an interrupt because the signal difference in the positive direction compared to sample 2 is more than `DeltaValue`.

Sample 7 and 8 will generate an interrupt because the signal difference in the positive direction compared to previous sample is more than `DeltaValue`.

A new reference value is stored at sample 11 and 12 because the signal is within limits, and the absolute signal difference between the current value and the last stored reference value is greater than 1.0

Error handling

If there is a subscription of interrupt on an analog input signal, an interrupt will be given for every change in the analog value that satisfies the condition specified when ordering the interrupt subscription. If the analog value is noisy many interrupts can be generated even if only one or two bits in the analog value are changed.

To avoid generating interrupts for small changes of the analog input value, set the `DeltaValue` to a level greater than 0. Then no interrupts will be generated until a change of the analog value is greater than the specified `DeltaValue`.

Continues on next page

1 Instructions

1.117 ISignalAI - Interrupts from analog input signal

RobotWare Base

Continued

The following recoverable errors can be generated. The errors can be handled in an ERROR handler. The system variable `ERRNO` will be set to:

Name	Cause of error
<code>ERR_NO_ALIASIO_DEF</code>	The signal variable is a variable declared in RAPID and it has not been connected to an I/O signal defined in the I/O configuration with instruction <code>AliasIO</code> .
<code>ERR_AO_LIM</code>	The programmed <code>HighValue</code> or <code>LowValue</code> argument for the specified analog input signal <code>Signal</code> is outside limits.
<code>ERR_NORUNUNIT</code>	There is no contact with the I/O device.

Limitations

The `HighValue` and `LowValue` arguments should be in the range: logical maximum value, logical minimum value defined for the signal.

`HighValue` must be above `LowValue`.

`DeltaValue` must be 0 or positive.

The limitations for the interrupt identity are the same as for `ISignalDI`.

Syntax

```
ISignalAI
  [ '\ Single ] | [ '\ SingleSafe ] ','
  [ Signal ' := ' ] <variable (VAR) of signalai> ','
  [ Condition ' := ' ] <expression (IN) of aiotrigg> ','
  [ HighValue ' := ' ] <expression (IN) of num> ','
  [ LowValue ' := ' ] <expression (IN) of num> ','
  [ DeltaValue ' := ' ] <expression (IN) of num>
  [ ['\DPos] | [ '\DNeg] ',' ]
  [ Interrupt ' := ' ] <variable (VAR) of intnum> ';'

```

Related information

For information about	See
Summary of interrupts and interrupt management	<i>Technical reference manual - RAPID Overview</i>
Definition of constants	aiotrigg - Analog I/O trigger condition on page 1597
Interrupt from analog output signal	ISignalAO - Interrupts from analog output signal on page 315
Interrupt from digital input signal	ISignalDI - Orders interrupts from a digital input signal on page 319
Interrupt from digital output signal	ISignalDO - Interrupts from a digital output signal on page 322
Interrupt identity	intnum - Interrupt identity on page 1675
Related system parameters (filter)	<i>Technical reference manual - System parameters</i>

1.118 ISignalAO - Interrupts from analog output signal

Usage

ISignalAO (*Interrupt Signal Analog Output*) is used to order and enable interrupts from an analog output signal.

Basic examples

The following examples illustrate the instruction ISignalAO:

Example 1

```
VAR intnum siglint;
PROC main()
  CONNECT siglint WITH iroutine1;
  ISignalAO \Single, aol, AIO_BETWEEN, 1.5, 0.5, 0, siglint;
```

Orders an interrupt which is to occur the first time the logical value of the analog output signal aol is between 0.5 and 1.5. A call is then made to the iroutine1 trap routine.

Example 2

```
ISignalAO aol, AIO_BETWEEN, 1.5, 0.5, 0.1, siglint;
```

Orders an interrupt which is to occur each time the logical value of the analog output signal aol is between 0.5 and 1.5, and the absolute signal difference compared to the previous stored reference value is bigger than 0.1.

Example 3

```
ISignalAO aol, AIO_OUTSIDE, 1.5, 0.5, 0.1, siglint;
```

Orders an interrupt which is to occur each time the logical value of the analog output signal aol is lower than 0.5 or higher than 1.5, and the absolute signal difference compared to the previous stored reference value is bigger than 0.1.

Arguments

```
ISignalAO [\Single] | [\SingleSafe] Signal Condition HighValue
          LowValue DeltaValue [\DPos] | [\DNeg] Interrupt
```

[\Single]

Data type: switch

Specifies whether the interrupt is to occur once or cyclically. If the argument Single is set the interrupt occurs once at the most. If the Single and SingleSafe argument is omitted an interrupt will occur each time its condition is satisfied.

[\SingleSafe]

Data type: switch

Specifies that the interrupt is single and safe. For definition of single, see description of Single argument. A safe interrupt cannot be put in sleep with instruction ISleep. The safe interrupt event will be queued at program stop and stepwise execution, and when starting in continuous mode again, the interrupt will be executed. The only time a safe interrupt will be thrown is when the interrupt queue is full. Then an error will be reported. The interrupt will not survive program reset, e.g. PP to main.

Continues on next page

1 Instructions

1.118 ISignalAO - Interrupts from analog output signal

RobotWare Base

Continued

Signal

Data type: `signalao`

The name of the signal that is to generate interrupts.

Condition

Data type: `aiotrigg`

Specifies how `HighValue` and `LowValue` define the condition to be satisfied:

Value	Symbolic constant	Comment
1	AIO_ABOVE_HIGH	Signal will generate interrupts if above specified high value
2	AIO_BELOW_HIGH	Signal will generate interrupts if below specified high value
3	AIO_ABOVE_LOW	Signal will generate interrupts if above specified low value
4	AIO_BELOW_LOW	Signal will generate interrupts if below specified low value
5	AIO_BETWEEN	Signal will generate interrupts if between specified low and high values
6	AIO_OUTSIDE	Signal will generate interrupts if below specified low value or above specified high value
7	AIO_ALWAYS	Signal will always generate interrupts

HighValue

Data type: `num`

High logical value to define the condition.

LowValue

Data type: `num`

Low logical value to define the condition.

DeltaValue

Data type: `num`

Defines the minimum logical signal difference before generation of a new interrupt. The current signal value compared to the previous stored reference value must be greater than the specified `DeltaValue` before generation of a new interrupt.

[`\DPos`]

Data type: `switch`

Specifies that only positive logical signal differences will give new interrupts.

[`\DNeg`]

Data type: `switch`

Specifies that only negative logical signal differences will give new interrupts.

If neither of the `\DPos` and `\DNeg` arguments are used, both positive and negative differences will generate new interrupts.

Interrupt

Data type: `intnum`

The interrupt identity. This interrupt should have previously been connected to a trap routine by means of the instruction `CONNECT`.

Continues on next page

Program execution

See instruction `ISignalAI` for information about:

- Program execution
- Condition for interrupt generation
- More examples

Same principles are valid for `ISignalAO` as for `ISignalAI`.

Error handling

The following recoverable errors can be generated. The errors can be handled in an ERROR handler. The system variable `ERRNO` will be set to:

Name	Cause of error
<code>ERR_NO_ALIASIO_DEF</code>	The signal variable is a variable declared in <code>RAPID</code> and it has not been connected to an I/O signal defined in the I/O configuration with instruction <code>AliasIO</code> .
<code>ERR_AO_LIM</code>	The programmed <code>HighValue</code> or <code>LowValue</code> argument for the specified analog input signal <code>Signal</code> is outside limits.
<code>ERR_NORUNUNIT</code>	There is no contact with the I/O device.

Limitations

The `HighValue` and `LowValue` arguments should be in the range: logical maximum value, logical minimum value, defined for the signal.

`HighValue` must be above `LowValue`.

`DeltaValue` must be 0 or positive.

The limitations for the interrupt identity are the same as for `ISignalDO`.

Syntax

```
ISignalAO
[ '\ Single ] | [ '\ SingleSafe ] ','
[ Signal':=' ]<variable (VAR) of signalao>',
[ Condition':=' ]<expression (IN) of aiotrigg>',
[ HighValue':=' ]<expression (IN) of num>',
[ LowValue':=' ]<expression (IN) of num>',
[ DeltaValue':=' ]<expression (IN) of num>
[[ '\ DPos ] | [ '\ DNeg ] ','
[ Interrupt':=' ]<variable (VAR) of intnum>;'
```

Related information

For information about	See
Summary of interrupts and interrupt management	<i>Technical reference manual - RAPID Overview</i>
Definition of constants	aiotrigg - Analog I/O trigger condition on page 1597
Interrupt from analog input signal	ISignalAI - Interrupts from analog input signal on page 305
Interrupt from digital input signal	ISignalDI - Orders interrupts from a digital input signal on page 319

Continues on next page

1 Instructions

1.118 ISignalAO - Interrupts from analog output signal

RobotWare Base

Continued

For information about	See
Interrupt from digital output signal	ISignalDO - Interrupts from a digital output signal on page 322
Interrupt identity	intnum - Interrupt identity on page 1675
Related system parameters (filter)	<i>Technical reference manual - System parameters</i>

1.119 ISignalDI - Orders interrupts from a digital input signal

Usage

ISignalDI (*Interrupt Signal Digital In*) is used to order and enable interrupts from a digital input signal.

Basic examples

The following examples illustrate the instruction ISignalDI:

Example 1

```
VAR intnum siglint;
PROC main()
  CONNECT siglint WITH iroutine1;
  ISignalDI di1,1,siglint;
```

Orders an interrupt which is to occur each time the digital input signal di1 is set to 1. A call is then made to the iroutine1 trap routine.

Example 2

```
ISignalDI di1,0,siglint;
```

Orders an interrupt which is to occur each time the digital input signal di1 is set to 0.

Example 3

```
ISignalDI \Single, di1,1,siglint;
```

Orders an interrupt which is to occur only the first time the digital input signal di1 is set to 1.

Arguments

```
ISignalDI [ \Single ] | [ \SingleSafe ] Signal TriggValue Interrupt
```

[\Single]

Data type: switch

Specifies whether the interrupt is to occur once or cyclically.

If the argument Single is set, the interrupt occurs once at the most. If the Single and SingleSafe arguments is omitted, an interrupt will occur each time its condition is satisfied.

[\SingleSafe]

Data type: switch

Specifies that the interrupt is single and safe. For definition of single, see description of Single argument. A safe interrupt cannot be put in sleep with instruction ISleep. The safe interrupt event will be queued at program stop and stepwise execution, and when starting in continuous mode again, the interrupt will be executed. The only time a safe interrupt will be thrown is when the interrupt queue is full. Then an error will be reported. The interrupt will not survive program reset, e.g. PP to main.

Signal

Data type: signaldi

Continues on next page

1 Instructions

1.119 ISignalDI - Orders interrupts from a digital input signal

RobotWare Base

Continued

The name of the signal that is to generate interrupts.

TriggValue

Data type: `dionum`

The value to which the signal must change for an interrupt to occur.

The value is specified as 0 or 1 or as a symbolic value (e.g. `high/low`). The signal is edge-triggered upon changeover to 0 or 1.

TriggValue 2 or symbolic value `edge` can be used for generation of interrupts on both positive flank (0 -> 1) and negative flank (1 -> 0).

Interrupt

Data type: `intnum`

The interrupt identity. This should have previously been connected to a trap routine by means of the instruction `CONNECT`.

Program execution

When the signal assumes the specified value a call is made to the corresponding trap routine. When this has been executed, program execution continues from where the interrupt occurred.

If the signal changes to the specified value before the interrupt is ordered no interrupt occurs. Interrupts from a digital input signal at signal level 1 is illustrated in the figure below.

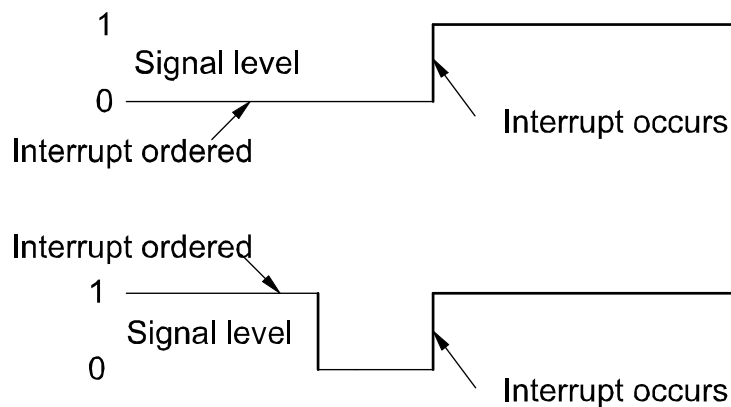

xx0500002189

Error handling

The following recoverable errors can be generated. The errors can be handled in an ERROR handler. The system variable `ERRNO` will be set to:

Name	Cause of error
<code>ERR_NO_ALIASIO_DEF</code>	The signal variable is a variable declared in RAPID and it has not been connected to an I/O signal defined in the I/O configuration with instruction <code>AliasIO</code> .
<code>ERR_NORUNUNIT</code>	There is no contact with the I/O device.

Continues on next page

Limitations

The same variable for interrupt identity cannot be used more than once without first deleting it. Interrupts should therefore be handled as shown in one of the alternatives below.

```
VAR intnum siglint;
PROC main ()
  CONNECT siglint WITH iroutine1;
  ISignalDI dil, 1, siglint;
  WHILE TRUE DO
    ...
  ENDWHILE
ENDPROC
```

All activation of interrupts is done at the beginning of the program. These beginning instructions are then kept outside the main flow of the program.

```
VAR intnum siglint;
PROC main ()
  CONNECT siglint WITH iroutine1;
  ISignalDI dil, 1, siglint;
  ...
  IDelete siglint;
ENDPROC
```

The interrupt is deleted at the end of the program and is then reactivated. Note, in this case, that the interrupt is inactive for a short period.

Syntax

```
ISignalDI
[ '\ ' Single ] | [ '\ ' SingleSafe ] ','
[ Signal ':=' ] < variable (VAR) of signaldi > ','
[ TriggValue ':=' ] < expression (IN) of dionum > ','
[ Interrupt ':=' ] < variable (VAR) of intnum > ';'
;
```

Related information

For information about	See
Summary of interrupts and interrupt management	<i>Technical reference manual - RAPID Overview</i>
Interrupt from an output signal	ISignalDO - Interrupts from a digital output signal on page 322
Interrupt identity	intnum - Interrupt identity on page 1675

1 Instructions

1.120 ISignalDO - Interrupts from a digital output signal

RobotWare Base

1.120 ISignalDO - Interrupts from a digital output signal

Usage

ISignalDO (*Interrupt Signal Digital Out*) is used to order and enable interrupts from a digital output signal.

Basic examples

The following examples illustrate the instruction ISignalDO:

Example 1

```
VAR intnum siglint;  
PROC main()  
  CONNECT siglint WITH iroutine1;  
  ISignalDO do1,1,siglint;
```

Orders an interrupt which is to occur each time the digital output signal do1 is set to 1. A call is then made to the iroutine1 trap routine.

Example 2

```
ISignalDO do1,0,siglint;
```

Orders an interrupt which is to occur each time the digital output signal do1 is set to 0.

Example 3

```
ISignalDO\Single, do1,1,siglint;
```

Orders an interrupt which is to occur only the first time the digital output signal do1 is set to 1.

Arguments

```
ISignalDO [ \Single ] | [ \SingleSafe ] Signal TriggValue Interrupt
```

[\Single]

Data type: switch

Specifies whether the interrupt is to occur once or cyclically.

If the argument Single is set, the interrupt occurs once at the most. If the Single and SingleSafe arguments is omitted, an interrupt will occur each time its condition is satisfied.

[\SingleSafe]

Data type: switch

Specifies that the interrupt is single and safe. For definition of single, see description of Single argument. A safe interrupt cannot be put in sleep with instruction ISleep. The safe interrupt event will be queued at program stop and stepwise execution, and when starting in continuous mode again, the interrupt will be executed. The only time a safe interrupt will be thrown is when the interrupt queue is full. Then an error will be reported. The interrupt will not survive program reset, e.g. PP to main.

Signal

Data type: signaldo

Continues on next page

The name of the signal that is to generate interrupts.

TriggValue

Data type: `dionum`

The value to which the signal must change for an interrupt to occur.

The value is specified as 0 or 1 or as a symbolic value (e.g. `high/low`). The signal is edge-triggered upon changeover to 0 or 1.

TriggValue 2 or symbolic value `edge` can be used for generation of interrupts on both positive flank (0 -> 1) and negative flank (1 -> 0).

Interrupt

Data type: `intnum`

The interrupt identity. This should have previously been connected to a trap routine by means of the instruction `CONNECT`.

Program execution

When the signal assumes the specified value 0 or 1, a call is made to the corresponding trap routine. When this has been executed program execution continues from where the interrupt occurred.

If the signal changes to the specified value before the interrupt is ordered no interrupt occurs. Interrupts from a digital output signal at signal level 1 is illustrated in the figure below.

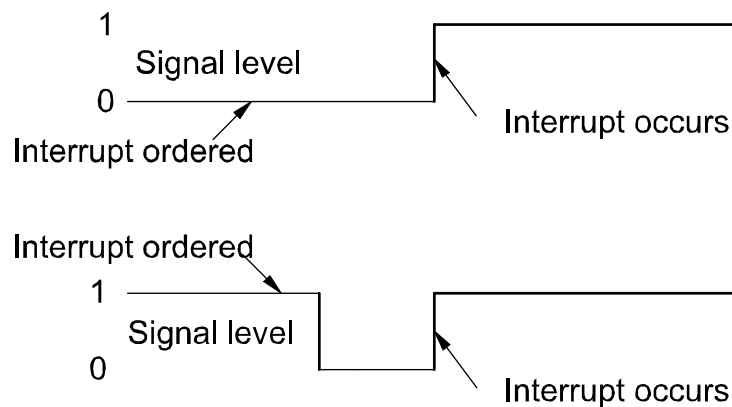

xx0500002190

Error handling

The following recoverable errors can be generated. The errors can be handled in an `ERROR` handler. The system variable `ERRNO` will be set to:

Name	Cause of error
<code>ERR_NO_ALIASIO_DEF</code>	The signal variable is a variable declared in <code>RAPID</code> and it has not been connected to an I/O signal defined in the I/O configuration with instruction <code>AliasIO</code> .
<code>ERR_NORUNUNIT</code>	There is no contact with the I/O device.

Continues on next page

1 Instructions

1.120 ISignalDO - Interrupts from a digital output signal

RobotWare Base

Continued

Limitations

The same variable for interrupt identity cannot be used more than once without first deleting it. Interrupts should therefore be handled as shown in one of the alternatives below.

```
VAR intnum siglint;
PROC main ()
  CONNECT siglint WITH iroutinel;
  ISignalDO do1, 1, siglint;
  WHILE TRUE DO
    ...
  ENDWHILE
ENDPROC
```

All activation of interrupts is done at the beginning of the program. These beginning instructions are then kept outside the main flow of the program.

```
VAR intnum siglint;
PROC main ()
  CONNECT siglint WITH iroutinel;
  ISignalDO do1, 1, siglint;
  ...
  IDelete siglint;
ENDPROC
```

The interrupt is deleted at the end of the program and is then reactivated. Note, in this case, that the interrupt is inactive for a short period.

Syntax

```
ISignalDO
  [ '\ ' Single ] | [ '\ ' SingleSafe ] ', '
  [ Signal ' := ' ] < variable (VAR) of signaldo > ', '
  [ TriggValue ' := ' ] < expression (IN) of dionum > ', '
  [ Interrupt ' := ' ] < variable (VAR) of intnum > ';'
```

Related information

For information about	See
Summary of interrupts and interrupt management	<i>Technical reference manual - RAPID Overview</i>
Interrupt from an input signal	ISignalDI - Orders interrupts from a digital input signal on page 319
Interrupt identity	intnum - Interrupt identity on page 1675

1.121 ISignalGI - Orders interrupts from a group of digital input signals

Usage

ISignalGI (*Interrupt Signal Group Digital In*) is used to order and enable interrupts from a group of digital input signals.

Basic examples

The following example illustrates the instruction ISignalGI:

Example 1

```
VAR intnum siglint;  
PROC main()  
    CONNECT siglint WITH iroutinel;  
    ISignalGI gil,siglint;
```

Orders an interrupt when a digital input group signal changes value.

Arguments

ISignalGI [\Single] | [\SingleSafe] Signal Interrupt

[\Single]

Data type: switch

Specifies whether the interrupt is to occur once or cyclically.

If the argument `Single` is set, the interrupt occurs once at the most. If the `Single` and `SingleSafe` arguments is omitted, an interrupt will occur each time its condition is satisfied.

[\SingleSafe]

Data type: switch

Specifies that the interrupt is single and safe. For definition of single, see description of `Single` argument. A safe interrupt cannot be put in sleep with instruction `ISleep`. The safe interrupt event will be queued at program stop and stepwise execution, and when starting in continuous mode again, the interrupt will be executed. The only time a safe interrupt will be thrown is when the interrupt queue is full. Then an error will be reported. The interrupt will not survive program reset, e.g. PP to main.

Signal

Data type: signalgi

The name of the group input signal that generates interrupts.

Interrupt

Data type: intnum

The interrupt identity. This should have previously been connected to a trap routine by means of the instruction `CONNECT`.

Continues on next page

1 Instructions

1.121 ISignalGI - Orders interrupts from a group of digital input signals

RobotWare Base

Continued

Program execution

When the group signal changes value a call is made to the corresponding trap routine. When this has been executed program execution continues from where the interrupt occurred.

If the signal changes before the interrupt is ordered no interrupt occurs.

When a digital group input signal is set to a value, this can generate several interrupts. The reason for this is that changes of the individual bits included in the group signal is not detected at the same time of the robot system. To avoid multiple interrupts for one group signal change, a filter time can be defined for the signal.

Error handling

The following recoverable errors can be generated. The errors can be handled in an ERROR handler. The system variable `ERRNO` will be set to:

Name	Cause of error
<code>ERR_NO_ALIASIO_DEF</code>	The signal variable is a variable declared in RAPID and it has not been connected to an I/O signal defined in the I/O configuration with instruction <code>AliasIO</code> .
<code>ERR_NORUNUNIT</code>	There is no contact with the I/O device.

Limitations

Maximum number of signals that can be used for a group is 32.

Numeric value condition cannot be used in the instruction to specify that an interrupt should occur on changes to that specific value. This must be handled in the user program by reading the group signal value at execution of the trap routine.

The interrupts are generated as bit interrupts, e.g. interrupts on single digital input signal change within the group. If the bits in the group signal change value with a delay between settings, several interrupts will be generated. Knowledge about how the I/O board works is necessary to get right function when using `ISignalGI`. If several interrupts are generated at group input settings, use instead `ISignalDI` on a strobe signal that are set when all bits in the group signal have been set.

The same variable for interrupt identity cannot be used more than once without first deleting it. Interrupts should therefore be handled as shown in one of the alternatives below.

```
VAR intnum siglint;  
PROC main ()  
  CONNECT siglint WITH iroutine1;  
  ISignalGI gil, siglint;  
  WHILE TRUE DO  
    ...  
  ENDWHILE  
ENDPROC
```

All activation of interrupts is done at the beginning of the program. These beginning instructions are then kept outside the main flow of the program.

```
VAR intnum siglint;  
PROC main ()  
  CONNECT siglint WITH iroutine1;
```

Continues on next page

1.121 ISignalGI - Orders interrupts from a group of digital input signals

RobotWare Base

Continued

```

ISignalGI gil, siglint;
...
IDelete siglint;
ENDPROC

```

The interrupt is deleted at the end of the program and is then reactivated. It should be noted, in this case, that the interrupt is inactive for a short period.

Syntax

```

ISignalGI
['\ ' Single] | ['\ ' SingleSafe'],'
[Signal ':= ' ] < variable (VAR) of signalgi>', '
[Interrupt ':= ' ] <variable (VAR) of intnum>';'

```

Related information

For information about	See
Summary of interrupts and interrupt management	<i>Technical reference manual - RAPID Overview</i>
Interrupt from an input signal	ISignalDI - Orders interrupts from a digital input signal on page 319
Interrupt from group output signals	ISignalGO - Orders interrupts from a group of digital output signals on page 328
Interrupt identity	intnum - Interrupt identity on page 1675
Filter time	<i>Technical reference manual - System parameters</i>

1 Instructions

1.122 ISignalGO - Orders interrupts from a group of digital output signals *RobotWare Base*

1.122 ISignalGO - Orders interrupts from a group of digital output signals

Usage

ISignalGO (*Interrupt Signal Group Digital Out*) is used to order and enable interrupts from a group of digital output signals.

Basic examples

The following example illustrates the instruction ISignalGO:

Example 1

```
VAR intnum siglint;  
PROC main()  
    CONNECT siglint WITH iroutinel;  
    ISignalGO gol,siglint;
```

Orders an interrupt when a digital output group signal change value.

Arguments

```
ISignalGO [ \Single ] | [ \SingleSafe ] Signal Interrupt
```

[\Single]

Data type: switch

Specifies whether the interrupt is to occur once or cyclically.

If the argument \Single is set, the interrupt occurs once at the most. If the Single and SingleSafe arguments is omitted, an interrupt will occur each time its condition is satisfied.

[\SingleSafe]

Data type: switch

Specifies that the interrupt is single and safe. For definition of single, see description of Single argument. A safe interrupt cannot be put in sleep with instruction ISleep. The safe interrupt event will be queued at program stop and stepwise execution, and when starting in continuous mode again, the interrupt will be executed. The only time a safe interrupt will be thrown is when the interrupt queue is full. Then an error will be reported. The interrupt will not survive program reset, e.g. PP to main.

Signal

Data type: signalgo

The name of the group output signal that generates interrupts.

Interrupt

Data type: intnum

The interrupt identity. This should have previously been connected to a trap routine by means of the instruction CONNECT.

Continues on next page

Program execution

When the group signal changes value a call is made to the corresponding trap routine. When this has been executed program execution continues from where the interrupt occurred.

If the signal changes before the interrupt is ordered no interrupt occurs.

Error handling

The following recoverable errors can be generated. The errors can be handled in an ERROR handler. The system variable `ERRNO` will be set to:

Name	Cause of error
<code>ERR_NO_ALIASIO_DEF</code>	The signal variable is a variable declared in RAPID and it has not been connected to an I/O signal defined in the I/O configuration with instruction <code>AliasIO</code> .
<code>ERR_NORUNUNIT</code>	There is no contact with the I/O device.

Limitations

Maximum number of signals that can be used for a group is 32.

Numeric value condition cannot be used in the instruction to specify that an interrupt should occur on changes to that specific value. This must be handled in the user program by reading the group signal value at execution of the trap routine.

The same variable for interrupt identity cannot be used more than once without first deleting it. Interrupts should therefore be handled as shown in one of the alternatives below.

```
VAR intnum siglint;
PROC main ()
  CONNECT siglint WITH iroutine1;
  ISignalGO gol, siglint;
  WHILE TRUE DO
    ...
  ENDWHILE
ENDPROC
```

All activation of interrupts is done at the beginning of the program. These beginning instructions are then kept outside the main flow of the program.

```
VAR intnum siglint;
PROC main ()
  CONNECT siglint WITH iroutine1;
  ISignalGO gol, siglint;
  ...
  IDelete siglint;
ENDPROC
```

The interrupt is deleted at the end of the program and is then reactivated. Note, in this case, that the interrupt is inactive for a short period.

Syntax

```
ISignalGO
  [ '\ ' Single ] | [ '\ ' SingleSafe ] ', '
  [ Signal ' := ' ] < variable (VAR) of signalgo > ', '
```

Continues on next page

1 Instructions

1.122 ISignalGO - Orders interrupts from a group of digital output signals

RobotWare Base

Continued

```
[ Interrupt' := ' ] < variable (VAR) of intnum > ';' 
```

Related information

For information about	See
Summary of interrupts and interrupt management	<i>Technical reference manual - RAPID Overview</i>
Interrupt from an output signal	ISignalDO - Interrupts from a digital output signal on page 322
Interrupt from group input signals	ISignalGI - Orders interrupts from a group of digital input signals on page 325
Interrupt identity	intnum - Interrupt identity on page 1675

1.123 ISleep - Deactivates an interrupt

Usage

ISleep(*Interrupt Sleep*) is used to deactivate an individual interrupt temporarily. During the deactivation time any generated interrupts of the specified type are discarded without any trap execution.

Basic examples

The following example illustrates the instruction ISleep.
See also [More examples on page 331](#).

Example 1

```
ISleep siglint;
```

The interrupt siglint is deactivated.

Arguments

```
ISleep Interrupt
```

Interrupt

Data type: intnum

The variable (interrupt identity) of the interrupt.

Program execution

Any generated interrupts of the specified type are discarded without any trap execution until the interrupt has been re-activated by means of the instruction IWatch. Interrupts which are generated while ISleep is in effect are ignored.

More examples

More examples of the instruction ISleep are illustrated below.

Example 1

```
VAR intnum timeint;
VAR iodev binfile;

PROC ISleep_example()
  CONNECT timeint WITH write_binfile;
  ITimer 6, timeint;
  !...
  ISleep timeint;
  WriteBin binfile, buffer, 30;
  WriteBin binfile, buffer2, 30;
  IWatch timeint;
  !...
ENDPROC

TRAP write_binfile
  WriteBin binfile, buffer3, 1;
ENDTRAP
```

Continues on next page

1 Instructions

1.123 ISleep - Deactivates an interrupt

RobotWare Base

Continued

Writing to the `binfile` file is done every 6 seconds. The interrupts are not permitted when the communication from main is in progress.

Error handling

The following recoverable errors can be generated. The errors can be handled in an ERROR handler. The system variable `ERRNO` will be set to:

Name	Cause of error
<code>ERR_UNKINO</code>	The interrupt number is unknown. Interrupts which have neither been ordered nor enabled are not permitted.
<code>ERR_INOISSAFE</code>	If trying to deactivate a safe interrupt temporarily with <code>ISleep</code> .

Syntax

```
ISleep  
  [ Interrupt ':=' ] < variable (VAR) of intnum > ';' 
```

Related information

For information about	See
Summary of interrupts	<i>Technical reference manual - RAPID Overview</i>
Enabling an interrupt	IWatch - Activates an interrupt on page 339
Disabling all interrupts	IDisable - Disables interrupts on page 253
Cancelling an interrupt	IDelete - Cancels an interrupt on page 252

1.124 ITimer - Orders a timed interrupt

Usage

`ITimer` (*Interrupt Timer*) is used to order and enable a timed interrupt. This instruction can be used, for example, to check the status of peripheral equipment once every minute.

Basic examples

The following examples illustrate the instruction `ITimer`:

See also [More examples on page 334](#).

Example 1

```
VAR intnum timeint;
PROC main()
  CONNECT timeint WITH iroutine1;
  ITimer 60, timeint;
```

Orders an interrupt that is to occur cyclically every 60 seconds. A call is then made to the trap routine `iroutine1`.

Example 2

```
ITimer \Single, 60, timeint;
```

Orders an interrupt that is to occur once, after 60 seconds.

Arguments

```
ITimer [ \Single ] | [ \SingleSafe ] Time Interrupt
```

[\Single]

Data type: switch

Specifies whether the interrupt is to occur once or cyclically.

If the argument `Single` is set, the interrupt occurs only once. If the `Single` and `SingleSafe` arguments is omitted, an interrupt will occur each time at the specified time.

[\SingleSafe]

Data type: switch

Specifies that the interrupt is single and safe. For definition of single, see description of `Single` argument. A safe interrupt cannot be put in sleep with instruction `ISleep`. The safe interrupt event will be queued at program stop and stepwise execution, and when starting in continuous mode again, the interrupt will be executed.

Time

Data type: num

The amount of time that must lapse before the interrupt occurs.

The value is specified in seconds. If `Single` or `SingleSafe` is set this time may not be less than 0.01 seconds. The corresponding time for cyclical interrupts is 0.1 seconds.

Continues on next page

1 Instructions

1.124 ITimer - Orders a timed interrupt

RobotWare Base

Continued

Interrupt

Data type: intnum

The variable (interrupt identity) of the interrupt. This should have previously been connected to a trap routine by means of the instruction `CONNECT`.

Program execution

The corresponding trap routine is automatically called at a given time following the interrupt order. When this has been executed program execution continues from where the interrupt occurred.

If the interrupt occurs cyclically a new computation of time is started from when the interrupt occurs.

More examples

More examples of the instruction `ITimer` are illustrated below.

Example 1

```
VAR intnum timeint;
VAR iodev binfile;

PROC ISleep_example()
  CONNECT timeint WITH write_binfile;
  ITimer 6, timeint;
  !...
  ISleep timeint;
  WriteBin binfile, buffer, 30;
  WriteBin binfile, buffer2, 30;
  IWatch timeint;
  !...
ENDPROC

TRAP write_binfile
  WriteBin binfile, buffer3, 1;
ENDTRAP
```

Writing to the `binfile` file is done every 6 seconds. The interrupts are not permitted when the communication from main is in progress.

Limitations

The same variable for interrupt identity cannot be used more than once without being first deleted. See Instructions - `ISignalDI`.

Syntax

```
ITimer
[ '\ ' Single ] | [ '\ ' SingleSafe ] ', '
[ Time := ] < expression (IN) of num > ', '
[ Interrupt := ] < variable (VAR) of intnum > ';'
```

Continues on next page

Related information

For information about	See
Summary of interrupts and interrupt management	<i>Technical reference manual - RAPID Overview</i>

1 Instructions

1.125 IVarValue - orders a variable value interrupt

Optical Tracking

1.125 IVarValue - orders a variable value interrupt

Usage

`IVarValue` (*Interrupt Variable Value*) is used to order and enable an interrupt when the value of a variable accessed via the sensor interface has been changed. This instruction can be used, for example, to get seam volume or gap values from a seam tracker.

Basic examples

The following example illustrates the instruction `IVarValue`:

Example 1

```
LOCAL PERS num
    adptVlt{25}:=[1,1.2,1.4,1.6,1.8,2,2.16667,2.33333,2.5,...];
LOCAL PERS num
    adptWfd{25}:=[2,2.2,2.4,2.6,2.8,3,3.16667,3.33333,3.5,...];
LOCAL PERS num
    adptSpd{25}:=[10,12,14,16,18,20,21.6667,23.3333,25[,...]];
LOCAL CONST num GAP_VARIABLE_NO:=11;
PERS num gap_value;
VAR intnum IntAdap;

PROC main()
    ! Setup the interrupt. The trap routine AdapTrp will be called
    ! when the gap variable with number 'GAP_VARIABLE_NO' in the
    ! sensor interface has been changed. The new value will be
    ! available in the PERS gp_value variable.
    ! Connect to the sensor device "sen1:" (defined in sio.cfg).
    SenDevice "sen1:";

    CONNECT IntAdap WITH AdapTrp;
    IVarValue "sen1:", GAP_VARIABLE_NO, gap_value, IntAdap;

    ! Start welding
    ArcL\On, *,v100,adaptSm,adaptWd,adaptWv,z10,tool\j\Track:=track;
    ArcL\On, *,v100,adaptSm,adaptWd,adaptWv,z10,tool\j\Track:=track;

ENDPROC

TRAP AdapTrap
    VAR num ArrInd;
    !Scale the raw gap value received
    ArrInd:=ArrIndx(gap_value);

    ! Update active welddata PERS variable 'adaptWd' with new data
    ! from the arrays of predefined parameter arrays. The scaled gap
    ! value is used as index in the voltage, wirefeed and
    ! speed arrays.
    adaptWd.weld_voltage:=adptVlt{ArrInd};
    adaptWd.weld_wirefeed:=adptWfd{ArrInd};
```

Continues on next page

```
adaptWd.weld_speed:=adptSpd{ArrInd};
```

```
!Request a refresh of AW parameters using the new data i adaptWd  
ArcRefresh;
```

```
ENDTRAP
```

Arguments

```
IVarValue device VarNo Value Interrupt [\Unit] [\DeadBand]  
[\ReportAtTool] [\SpeedAdapt] [\APTR]
```

device

Data type: string

The I/O device name configured in `sio.cfg` for the sensor used.

VarNo

Data type: num

The number of the variable to be supervised.

Value

Data type: num

A PERS variable which will hold the new value of VarNo.

Interrupt

Data type: intnum

The variable (interrupt identity) of the interrupt. This should have previously been connected to a trap routine by means of the instruction `CONNECT`.

[\Unit]

Data type: num

Scale factor with which the sensor value for VarNo is multiplied before check and before it is saved in Value.

[\DeadBand]

Data type: num

If the value for VarNo, returned by the sensor, is within +/- DeadBand no interrupt is generated.

[\ReportAtTool]

Data type: switch

This optional argument is only available for sensors of look-ahead type, for example optical tracking sensors. The argument specifies that the value of the variable shall not be evaluated at once but when the robot TCP reaches the position, i.e. the look-ahead is compensated.

[\SpeedAdapt]

Data type: num

\SpeedAdapt is a scale factor used to change the process speed in Arc and Cap instructions. It is multiplied with the sensor value for VarNo according to:

Continues on next page

1 Instructions

1.125 IVarValue - orders a variable value interrupt

Optical Tracking

Continued

process speed = \SpeedAdapt * value(VarNo)

[\APTR]

Data type: switch

Specifies that the subscription of the variable should be coupled to the at-point tracker, for example WeldGuide, specified in the argument *device*.

Program execution

The corresponding trap routine is automatically called at a given time following the interrupt order. When this has been executed program execution continues from where the interrupt occurred.

Limitations

- The same variable for interrupt identity cannot be used more than five times without first being deleted.
- All interrupts that are setup with IVarValue must be setup again after a controller restart.



CAUTION

Too high interrupt frequency will stall the whole RAPID execution.

Syntax

```
IVarValue
[ device ':=' ] < expression (IN) of string > ','
[ VarNo ':=' ] < expression (IN) of num > ','
[ Value ':=' ] < persistent (PERS) of num > ','
[ Interrupt ':=' ] < variable (VAR) of intnum > ','
[ '\ Unit ':=' ] < expression (IN) of num > ','
[ '\ DeadBand ':=' ] < expression (IN) of num > ','
[ '\ ReportAtTool ] ','
[ '\ SpeedAdapt ':=' ] < expression (IN) of num > ','
[ '\ APTR ] ';'

```

Related information

For information about	See
Connect to a sensor device	SenDevice - connect to a sensor device on page 688
Summary of interrupts and interrupt management	<i>Technical reference manual - RAPID Overview</i>
Optical Tracking	<i>Application manual - Continuous Application Platform</i>
Optical Tracking Arc	<i>Application manual - Arc and Arc Sensor</i>

1.126 IWatch - Activates an interrupt

Usage

`IWatch(Interrupt Watch)` is used to activate an interrupt which was previously ordered but was deactivated with `ISleep`.

Basic examples

The following example illustrates the instruction `IWatch`:

See also [More examples on page 339](#).

Example 1

```
IWatch siglint;
```

The interrupt `siglint` that was previously deactivated is activated.

Arguments

```
IWatch Interrupt
```

Interrupt

Data type: `intnum`

Variable (interrupt identity) of the interrupt.

Program execution

Re-activates interrupts of the specified type. Interrupts generated during the time the `ISleep` instruction was in effect are ignored.

Error handling

The following recoverable errors can be generated. The errors can be handled in an ERROR handler. The system variable `ERRNO` will be set to:

Name	Cause of error
<code>ERR_UNKINO</code>	The interrupt number is unknown. Interrupts which have neither been ordered nor enabled are not permitted.

More examples

More examples of the instruction `IWatch` are illustrated below.

Example 1

```

VAR intnum siglint;
PROC main()
  CONNECT siglint WITH iroutine1;
  ISignalDI di1,1,siglint;
  ...
  ISleep siglint;
  weldpart1;
  IWatch siglint;

```

During execution of the `weldpart1` routine no interrupts are permitted from the signal `di1`.

Continues on next page

1 Instructions

1.126 IWatch - Activates an interrupt

RobotWare Base

Continued

Syntax

```
IWatch  
    [ Interrupt ':= ' ] < variable (VAR) of intnum > ';' 
```

Related information

For information about	See
Summary of interrupts	<i>Technical reference manual - RAPID Overview</i>
Deactivating an interrupt	ISleep - Deactivates an interrupt on page 331

1.127 Label - Line name

Usage

Label is used to name a line in the program. Using the GOTO instruction, this name can then be used to move program execution within the same routine.

Basic examples

The following example illustrates the instruction Label:

Example 1

```
GOTO next ;  
...  
next :
```

Program execution continues with the instruction following next.

Arguments

Label :

Label

Identifier

The name you wish to give the line.

Program execution

Nothing happens when you execute this instruction.

Limitations

The label must not be the same as

- any other label within the same routine.
- any data name within the same routine.

A label hides global data and routines with the same name within the routine it is located in.

Syntax

```
<identifier>':'
```

Related information

For information about	See
Identifiers	<i>Technical reference manual - RAPID Overview</i>
Moving program execution to a label	GOTO - Goes to a new instruction on page 241

1 Instructions

1.128 Load - Load a program module during execution *RobotWare Base*

1.128 Load - Load a program module during execution

Usage

Load is used to load a program module into the program memory during execution. The loaded program module will be added to the already existing modules in the program memory.

A program or system module can be loaded in static (default) or dynamic mode. Both static and dynamic loaded modules can be unloaded by the instruction UnLoad.

Static mode

The following table describes how different operations affect static loaded program or system modules.

Type of module	Set PP to main from FlexPendant	Open new RAPID program
Program Module	Not affected	Unloaded
System Module	Not affected	Not affected

Dynamic mode

The following table describes how different operations affect dynamic loaded program or system modules.

Type of module	Set PP to main from FlexPendant	Open new RAPID program
Program Module	Unloaded	Unloaded
System Module	Unloaded	Unloaded

Basic examples

The following examples illustrate the instruction Load:

See also [More examples on page 344](#).

Example 1

```
Load \Dynamic, diskhome \File:="PART_A.MOD";
```

Loads the program module PART_A.MOD from the diskhome into the program memory. diskhome is a predefined string constant "HOME:". Load the program module in the dynamic mode.

Example 2

```
Load \Dynamic, diskhome \File:="PART_A.MOD";  
Load \Dynamic, diskhome \File:="PART_B.MOD" \CheckRef;
```

Loads the program module PART_A.MOD into the program memory, then PART_B.MOD is loaded. If PART_A.MOD contains references to PART_B.MOD, \CheckRef can be used to check for unresolved references only when the last module is loaded. IF \CheckRef is used on PART_A.MOD, a link error would occur and the module would not be loaded.

Arguments

```
Load [\Dynamic] FilePath [\File] [\CheckRef]
```

Continues on next page

[\Dynamic]

Data type: `switch`

The switch enables load of a module in dynamic mode. Otherwise the load is in static mode.

FilePath

Data type: `string`

The file path and the file name to the file that will be loaded into the program memory. The file name shall be excluded when the argument `\File` is used.

[\File]

Data type: `string`

When the file name is excluded in the argument `FilePath` then it must be defined with this argument.

[\CheckRef]

Data type: `switch`

Check after loading of the module for unsolved references in the program task. If not used no check for unsolved references are done.

Program execution

Program execution waits for the program module to finish loading before proceeding with the next instruction.

Unresolved references will always be accepted for the loading operation, if parameter `\CheckRef` is not used, but it will be a run time error on execution of an unresolved reference.

After the program module is loaded it will be linked and initialized. The initialization of the loaded module sets all variables at module level to their unit values.

If any error from the loading operation, including unresolved references if use of switch `\CheckRef`, the loaded module will not be available any more in the program memory.

To obtain a good program structure that is easy to understand and maintain, all loading and unloading of program modules should be done from the main module which is always present in the program memory during execution.

For loading of program that contains a main procedure to a main program (with another main procedure), see example in [More examples on page 344](#) below.



Note

Be aware of that `Load`, `UnLoad`, and `WaitLoad` can affect both the motion execution and other RAPID execution and shall therefore be called with caution.

Continues on next page

1 Instructions

1.128 Load - Load a program module during execution

RobotWare Base

Continued

Error handling

The following recoverable errors can be generated. The errors can be handled in an ERROR handler. The system variable `ERRNO` will be set to:

Name	Cause of error
<code>ERR_FILNOTFND</code>	The file specified in the <code>Load</code> instruction cannot be found.
<code>ERR_IOERROR</code>	There is a problem reading the file in the <code>Load</code> instruction.
<code>ERR_PRGMEMFULL</code>	The module cannot be loaded because the program memory is full.
<code>ERR_LOADED</code>	The module is already loaded into the program memory.
<code>ERR_SYNTAX</code>	The loaded module contains syntax errors.
<code>ERR_LINKREF</code>	<ul style="list-style-type: none">The loaded module result in fatal link errors.If <code>Load</code> is used with the switch <code>\CheckRef</code> to check for any reference error, and the program memory contains unresolved references.

If some of these error occurs the actual module will be unloaded and will not be available in the `ERROR` handler.

More examples

More examples of how to use the instruction `Load` are illustrated below.

More general examples

```
Load \Dynamic, "HOME:/DOORDIR/DOOR1.MOD";
```

Loads the program module `DOOR1.MOD` from `HOME:` at the directory `DOORDIR` into the program memory. The program module is loaded in the dynamic mode.

```
Load "HOME:" \File:="DOORDIR/DOOR1.MOD";
```

Same as above but another syntax, and the module is loaded in the static mode.

```
Load\Dynamic, "HOME:/DOORDIR/DOOR1.MOD";
```

```
%"routine_x"%;
```

```
UnLoad "HOME:/DOORDIR/DOOR1.MOD";
```

Procedure `routine_x`, will be binded during execution (late binding).

Loaded module contains a main procedure

car.mod:

```
MODULE car
  PROC main()
    ...
    TEST part
    CASE door_part:
      Load \Dynamic, "HOME:/door.mod";
      %door:main%;
      Unload "HOME:/door.mod";
    CASE window_part:
      Load \Dynamic, "HOME:/window.mod";
      %window:main%;
      Unload \Save "HOME:/window.mod";
    ENDTTEST
```

Continues on next page

```

ENDPROC
ENDMODULE

```

door.mod:

```

MODULE door
  PROC main()
    ...
  ENDPROC
ENDMODULE

```

window.mod:

```

MODULE window
  PROC main()
    ...
  ENDPROC
ENDMODULE

```

The above example shows how you can load a module which includes a `main` procedure. This module can have been developed and tested separately and later loaded with `Load` or `StartLoad... WaitLoad` into the system using some type of main program framework. In this example `car.mod`, which loads other modules `door.mod` or `window.mod`.

In the module `car.mod` you load `door.mod` or `window.mod` located at `"HOME:"`. Because the main procedures in `door.mod` and `window.mod` after the loading are considered **LOCAL** in the module by the system, the procedure calls are made in the following way: `%"door:main"%` or `%"window: main"%`. This syntax is used when you want to get access to **LOCAL** procedures in other modules in this example procedure `main` in module `door` or module `window`.

Unloading the modules with `\Save` argument will again make the `main` procedures global in the saved program.

If you, when the module `car` or `window` are loaded in the system, set program pointer to `main` from any part of the program, the program pointer will always be set to the global `main` procedure in the main module, `car.mod` in this example.

Limitations

Avoid ongoing robot movements during the loading.

Syntax

```

Load
  ['\Dynamic',']
  [FilePath':=']<expression (IN) of string>
  ['\File':=' <expression (IN) of string>]
  ['\CheckRef'];'

```

Continues on next page

1 Instructions

1.128 Load - Load a program module during execution

RobotWare Base

Continued

Related information

For information about	See
Unload a program module	UnLoad - Unload a program module during execution on page 1010
Load a program module in parallel with another program execution	StartLoad - Load a program module during execution on page 787 WaitLoad - Connect the loaded module to the task on page 1061
Check program references	CheckProgRef - Check program references on page 130

1.129 LoadId - Load identification of tool or payload

Usage

LoadId (*Load Identification*) can be used for load identification of tool (also gripper tool if roomfix TCP) or payload (activates with instruction GripLoad) by executing a user defined RAPID program.



Note

An alternative way to identify the tool load or payload is to use the service routine LoadIdentify. See *Operating manual - IRC5 with FlexPendant*, section *Service routines*.



Note

When using LoadId or LoadIdentification to identify the load of a tool or payload with unknown mass, the mass is estimated using the manipulator and the result can deviate from the actual mass. This is due to tolerances and variations between mechanical units. This does not necessarily mean that the identified payload or tool will cause issues with motion performance. If a very accurate value for the mass is required, it is recommended to weigh the tool or payload and use known mass in the identification.

Basic examples

The following example illustrates the instruction LoadId:

See also [More examples on page 351](#).

Example 1

```

VAR bool invalid_pos := TRUE;
VAR jointtarget joints;
VAR bool valid_joints{12};
CONST speeddata low_ori_speed := [20, 5, 20, 5];
VAR bool slow_test_flag := TRUE;
PERS tooldata grip3 := [ TRUE, [[97.4, 0, 223.1], [0.924, 0, 0.383
,0]], [0, [0, 0, 0], [1, 0, 0, 0], 0, 0, 0]];
! Check if valid robot type
IF ParIdRobValid(TOOL_LOAD_ID) <> ROB_LOAD_VAL THEN
  EXIT;
ENDIF
! Check if valid robot position
WHILE invalid_pos = TRUE DO
  joints := CJointT();
  IF ParIdPosValid (TOOL_LOAD_ID, joints, valid_joints) = TRUE THEN
    ! Valid position
    invalid_pos := FALSE;
  ELSE
    ! Invalid position
    ! Adjust the position by program movements (horizontal tilt
    house)
  
```

Continues on next page

1 Instructions

1.129 LoadId - Load identification of tool or payload

RobotWare Base

Continued

```
        MoveAbsJ joints, low_ori_speed, fine, tool0;
    ENDIF
ENDWHILE
! Do slow test for check of free working area
! Load modules into the system
Load \Dynamic, "RELEASE:/system/mockit.sys";
Load \Dynamic, "RELEASE:/system/mockit1.sys";
IF slow_test_flag = TRUE THEN
    %"LoadId"% TOOL_LOAD_ID, MASS_WITH_AX3, grip3 \SlowTest;
ENDIF
! Do measurement and update all load data in grip3
%"LoadID"% TOOL_LOAD_ID, MASS_WITH_AX3, grip3;
! Unload modules
Unload "RELEASE:/system/mockit.sys";
Unload "RELEASE:/system/mockit1.sys";
```

Load identification of tool grip3.

Condition

The following conditions should be fulfilled before load measurements with LoadId:

- Ensure that all loads are correctly mounted on the robot
- Check whether valid robot type with ParIdRobValid
- Check whether valid position with ParIdPosValid:
 - Axes 3, 5, and 6 not close to their corresponding working range
 - Tilthousing almost horizontal, i.e. that axis 4 is in zero position
- The following data should be defined in system parameters and in arguments to LoadId before running LoadId

The table below illustrates the load identification of tool.

Load identification modes / Defined data before LoadId	Moving TCP Mass Known	Moving TCP Mass Un-known	Roomfix TCP Mass Known	Roomfix TCP Mass Un-known
Upper arm load (System parameters)		Defined		Defined
Mass in tool	Defined		Defined	

The table below illustrates the load identification of payload.

Load identification modes / Defined data before LoadId	Moving TCP Mass Known	Moving TCP Mass Un-known	Roomfix TCP Mass Known	Roomfix TCP Mass Un-known
Upper arm load (System parameters)		Defined		Defined
Load data in tool	Defined	Defined	Defined	Defined
Mass in payload	Defined		Defined	
Tool frame in tool	Defined	Defined		
User frame in work object			Defined	Defined
Object frame in work object			Defined	Defined

Continues on next page

- Operating mode and speed override:
 - Slow test in manual mode reduced speed
 - Load measurements in automatic mode (or manual mode full speed) with speed override 100%

Arguments

LoadId ParIdType LoadIdType Tool [\PayLoad] [\WObj] [\ConfAngle] [\SlowTest] [\Accuracy]

ParIdType

Data type: paridnum

Type of load identification as defined in the table below.

Value	Symbolic constant	Comment
1	TOOL_LOAD_ID	Identify tool load
2	PAY_LOAD_ID	Identify payload (ref. instruction GripLoad)

LoadIdType

Data type: loadidnum

Type of load identification as defined in the table below.

Value	Symbolic constant	Comment
1	MASS_KNOWN	Known mass in tool or payload respectively. (Mass in specified Tool or PayLoad must be specified)
2	MASS_WITH_AX3	Unknown mass in tool or payload respectively. Identification of mass in tool or payload will be done with movements of axis 3

Tool

Data type: tooldata

Persistent variable for the tool to be identified. If argument \PayLoad is specified, the persistent variable for the tool in use.

For load identification of tool, the following arguments \PayLoad and \WObj should not be specified.

[\ PayLoad]

Data type: loaddata

Persistent variable for the payload to be identified.

This optional argument must always be specified for load identification of payload.

[\ WObj]

Data type: wobjdata

Persistent variable for the work object in use.

This optional argument must always be specified for load identification of payload with roomfix TCP.

Continues on next page

1 Instructions

1.129 LoadId - Load identification of tool or payload

RobotWare Base

Continued

[\ ConfAngle]

Data type: num

Optional argument for specification of a specific configuration angle \pm degrees to be used for the parameter identification.

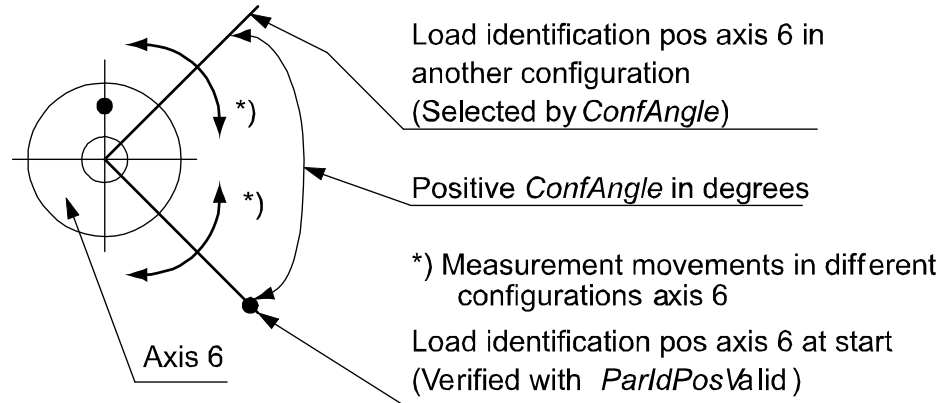

xx0500002198

Default is +90 degrees if this argument is not specified. Minimum ± 30 degrees. Optimum ± 90 degrees.

For 5-axis delta manipulators the configuration axis is axis 5. The configuration angle will give a delta movement of ± 45 degrees from the standard input of 90 degrees.

[\ SlowTest]

Data type: switch

Optional argument to specify whether only slow test for checking of free working area should be done. See table below:

LoadId ... \SlowTest	Run only slow test
LoadId ...	Run only measurement and update tool or payload

[\ Accuracy]

Data type: num

Variable for output of calculated measurement accuracy in % for the whole load identification calculation (100% means maximum accuracy).

Program execution

The robot will carry out a large number of relative small transport and measurement movements on axes 5 and 6. For identification of mass, movements will also be made with axis 3.

After all measurements, movements, and load calculations the load data is returned in argument *Tool* or *PayLoad*. The following load data is calculated:

- Mass in kg (if mass is unknown otherwise not affected)
- Center of gravity x, y, z, and axes of moment
- Inertia ix, iy, iz in kgm

Continues on next page

Error handling

The following recoverable errors can be generated. The errors can be handled in an ERROR handler. The system variable `ERRNO` will be set to:

Name	Cause of error
ERR_PID_MOVESTOP	At any error during the execution of the RAPID <code>NOSTEPIN</code> routine <code>LoadId</code> . The program pointer is raised to the user call of <code>LoadId</code> .
ERR_PID_RAISE_PP	
ERR_LOADID_FATAL	

More examples

More examples of the instruction `LoadId` are illustrated below.

Example 1

```
PERS tooldata grip3 := [ FALSE, [[97.4, 0, 223.1], [0.924, 0, 0.383
,0]], [6, [10, 10, 100], [0.5, 0.5, 0.5, 0.5], 1.2, 2.7,
0.5]];
PERS loaddata piece5 := [ 5, [0, 0, 0], [1, 0, 0, 0], 0, 0, 0];
PERS wobjdata wobj2 := [ TRUE, TRUE, "", [ [34, 0, -45], [0.5,
-0.5, 0.5 ,-0.5] ], [ [0.56, 10, 68], [0.5, 0.5, 0.5 ,0.5] ]
];
VAR num load_accuracy;
! Load modules into the system
Load \Dynamic, "RELEASE:/system/mockit.sys";
Load \Dynamic, "RELEASE:/system/mockit1.sys";
! Do measurement and update all payload data except mass in piece5
%"LoadId"% PAY_LOAD_ID, MASS_KNOWN, grip3 \Payload:=piece5
\Wobj:=wobj2 \Accuracy:=load_accuracy;
TPWrite " Load accuracy for piece5 (%) = " \Num:=load_accuracy;
! Unload modules
Unload "RELEASE:/system/mockit.sys";
Unload "RELEASE:/system/mockit1.sys";
```

Load identification of payload `piece5` with known mass in installation with roomfix TCP.

Limitations

Usually load identification of tool or payload for the robot is done with the service routine `LoadIdentify`. It is also possible to do this identification with this RAPID instruction `LoadId`. Before loading or executing the program with `LoadId` following modules must be loaded to the system:

```
Load \Dynamic, "RELEASE:/system/mockit.sys";
Load \Dynamic, "RELEASE:/system/mockit1.sys";
```

Then it is possible to call `LoadId` with a late binding call (see example 1 above).

It is not possible to restart the load identification movements after any type of stop such as program stop, emergency stop, or power failure. The load identification movements must then be started from the beginning.

Syntax

```
LoadId
[ ParIdType ::= ] <expression (IN) of paridnum> ',
```

Continues on next page

1 Instructions

1.129 LoadId - Load identification of tool or payload

RobotWare Base

Continued

```
[ LoadIdType ':=' ] <expression (IN) of loadidnum> ','  
[ Tool ':=' ] <persistent (PERS) of tooldata>  
[ '\ PayLoad ':=' <persistent (PERS) of loaddata> ]  
[ '\ WObj ':=' <persistent (PERS) of wobjdata> ]  
[ '\ ConfAngle ':=' <expression (IN) of num> ]  
[ '\ SlowTest ]  
[ '\ Accuracy ':=' <variable (VAR) of num> ] ';' 
```

Related information

For information about	See
Predefined program Load Identify	<i>Operating manual - IRC5 with FlexPendant</i>
Type of parameter identification	paridnum - Type of parameter identification on page 1707
Result of ParIdRobValid	paridvalidnum - Result of ParIdRobValid on page 1709
Type of load identification	loadidnum - Type of load identification on page 1688
Valid robot type	ParIdRobValid - Valid robot type for parameter identification on page 1392
Valid robot position	ParIdPosValid - Valid robot position for parameter identification on page 1389

1.130 MakeDir - Create a new directory

Usage

`MakeDir` is used to create a new directory. The user must have write and execute permission for the parent directory under which the new directory is created.

Basic examples

The following example illustrates the instruction `MakeDir`:

Example 1

```
MakeDir "HOME:/newdir";
```

This example creates a new directory, called `newdir`, under `HOME`:

Arguments

```
MakeDir Path
```

Path

Data type: `string`

The name of the new directory specified with full or relative path.

Error handling

The following recoverable errors can be generated. The errors can be handled in an `ERROR` handler. The system variable `ERRNO` will be set to:

Name	Cause of error
<code>ERR_FILEACC</code>	The directory cannot be created.

Syntax

```
MakeDir  
[ Path':=' ] < expression (IN) of string>';'
```

Related information

For information about	See
Remove a directory	RemoveDir - Delete a directory on page 602
Rename a file	RenameFile - Rename a file on page 607
Remove a file	RemoveFile - Delete a file on page 604
Copy a file	CopyFile - Copy a file on page 167
Check file type	IsFile - Check the type of a file on page 1343
Check file size	FileSize - Retrieve the size of a file on page 1274
Check file system size	FSSize - Retrieve the size of a file system on page 1280
File and I/O device handling	Application manual - Controller software IRC5

1 Instructions

1.131 ManLoadIdProc - Load identification of IRBP manipulators

RobotWare Base

1.131 ManLoadIdProc - Load identification of IRBP manipulators

Usage

ManLoadIdProc (*Manipulator Load Identification Procedure*) is used for load identification of payload for external manipulators by executing a user defined RAPID program.

This instruction can only be used in the main task T_ROB1 or, if in a *MultiMove* system, in Motion tasks.



Note

An easier way to identify the payload is to use the service routine ManLoadIdentify. This service routine can be started from the menu **Program Editor, Debug, Call Routine, ManLoadIdentify**.

Basic examples

The following examples illustrate the instruction ManLoadIdProc:

```
PERS loaddata myload := [6,[0,0,0],[1,0,0,0],0,0,0];
VAR bool defined;
ActUnit STN1;
ManLoadIdProc \ParIdType := IRBP_L
  \MechUnit := STN1
  \PayLoad := myload
  \ConfigAngle := 60
  \AlreadyActive
  \DefinedFlag := defined;
DeactUnit STN1;
```

Load identification of payload myload mounted on the mechanical unit STN1. The external manipulator is of type IRBP-L. The configuration angle is set to 60 degrees. The manipulator is activated before the load identification and deactivated after. After the identification myload has been updated and defined it is set to TRUE.

Arguments

```
ManLoadIdProc [ \ParIdType ] [ \MechUnit ] | [ \MechUnitName ]
               [ \AxisNumber ] [ \PayLoad ] [ \ConfigAngle ] [ \DeactAll ] |
               [ \AlreadyActive ] [ DefinedFlag ] [ DoExit ]
```

[\ ParIdType]

Data type: paridnum

Type of parameter identification. Predefined constants are found under the datatype paridnum.

[\ MechUnit]

Data type: mecunit

Mechanical unit used for the load identification. Cannot be used together with argument \MechUnitName.

Continues on next page

[\ MechUnitName]

Data type: string

Mechanical unit used for the load identification given as a string. Cannot be used together with argument \MechUnit.

[\ AxisNumber]

Data type: num

Axis number within the mechanical unit, which holds the load to be identified.

[\ PayLoad]

Data type: loaddata

Variable for the payload to be identified. The component mass must be specified. This variable will be updated after the identification is done.

[\ ConfigAngle]

Data type: num

Specification of a specific configuration angle \pm degrees to be used for the parameter identification.

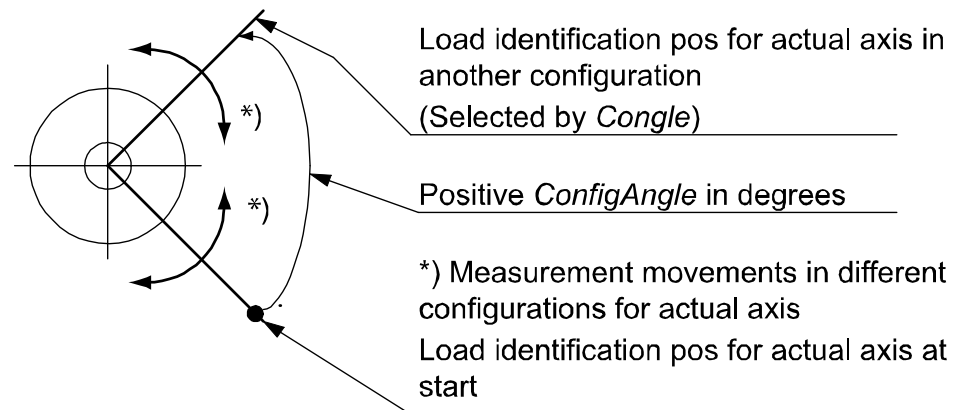

xx0500002197

Min. + or - 30 degrees. Optimum + or - 90 degrees.

[\ DeactAll]

Data type: switch

If this switch is used all mechanical units in the system will be deactivated before identification is done. The mechanical unit to identify will then be activated. It cannot be used together with argument \AlreadyActive.

[\ AlreadyActive]

Data type: switch

This switch is used if the mechanical unit to identify is active. It cannot be used together with argument \DeactAll.

[\ DefinedFlag]

Data type: bool

Continues on next page

1 Instructions

1.131 ManLoadIdProc - Load identification of IRBP manipulators

RobotWare Base

Continued

This argument will be set to `TRUE` if the identification has been made, `FALSE` otherwise.

[\ DoExit]

Data type: `bool`

If set to `TRUE` the load identification will end up with an `EXIT` command to force the user to set `PP` to main before continuing the execution. If not present or set to `FALSE` no `EXIT` will be done. Note that `ManLoadIdProc` always clears the current path.

Program execution

All arguments are optional. If an argument is not given the user will be asked for the value from the FlexPendant (except for `\DoExit`).

The user will always be asked to give the mass and if the manipulator is of type `IRBP R`, `z` in mm.

The mechanical unit will carry out a large number of relative small transport and measurement movements.

After all measurements, movements, and load calculations the load data is returned in argument `Payload` if used. The following load data is calculated.

Manipulator type/ Calculated load data	IRBP-K	IRBP-L IRBP-C IRBP_T	IRBP-R	IRBP-A IRBP-B IRBP-D
Parameter <code>Payload</code> - <code>cog.x</code> , <code>cog.y</code> , <code>cog.z</code> in <code>loaddata</code> in mm	<code>cog.x cog.y</code>	<code>cog.x cog.y</code>	<code>cog.x cog.y</code>	<code>cog.x cog.y cog.z</code>
Parameter <code>Payload</code> - <code>ix</code> , <code>iy</code> , <code>iz</code> in <code>loaddata</code> in <code>kgm²</code>	<code>iz</code>	<code>iz</code>	<code>ix</code> <code>iy</code> <code>iz</code>	<code>ix</code> <code>iy</code> <code>iz</code>

The calculated data will be displayed on the FlexPendant.

Error handling

The following recoverable errors can be generated. The errors can be handled in an `ERROR` handler. The system variable `ERRNO` will be set to:

Name	Cause of error
<code>ERR_PID_MOVESTOP</code>	At any error during the execution of the <code>RAPID NOSTEPIN</code> routine <code>ManLoadIdProc</code> . The program pointer is raised to the user call of <code>ManLoadIdProc</code> .
<code>ERR_PID_RAISE_PP</code>	
<code>ERR_LOADID_FATAL</code>	

Limitations

Usually load identification of load for the external manipulator is done with the service routine `ManLoadIdentify`. It is also possible to do this identification with this `RAPID` instruction `ManLoadIdProc`.

Any path in progress will be cleared before the load identification. The program pointer will be lost after the load identification if argument `\DoExit:=TRUE` is used.

Continues on next page

It is not possible to restart the load identification movements after any type of stop, such as program stop, emergency stop, or power failure. The load identification movements must be again restarted from the beginning.

Syntax

```
ManLoadIdProc
[ '\ParIdType' := <expression (IN) of paridnum> ]
[ '\MechUnit' := <variable (VAR) of mecunit> ]
| [ '\MechUnitName' := <expression (IN) of string> ]
[ '\AxisNumber' := <expression (IN) of num> ]
[ '\Payload' := <var or pers (INOUT) of loaddata> ]
[ '\ConfigAngle' := <expression (IN) of num> ]
[ '\DeactAll' ] | [ '\AlreadyActive' ]
[ '\DefinedFlag' := <variable (VAR) of bool> ]
[ '\DoExit' := <expression (IN) of bool> ] ';'

```

Related information

For information about	See
Type of parameter identification	paridnum - Type of parameter identification on page 1707
Mechanical unit	mecunit - Mechanical unit on page 1690
Payload	loaddata - Load data on page 1682

1 Instructions

1.132 MatrixAdd - Calculates the sum of two matrices

RobotWare Base

1.132 MatrixAdd - Calculates the sum of two matrices

Usage

MatrixAdd is used to calculate the sum of two matrices.

Basic examples

The following examples illustrate the instruction MatrixAdd.

Example 1

```
VAR dnum A1{2, 2}:=[[1, 5], [-4, 3]];
VAR dnum B1{2, 2}:=[[2, -1], [4, -1]];
VAR dnum Result1{2, 2};
..
MatrixAdd A1, B1, Result1;
FOR i FROM 1 TO Dim(Result1,1) DO
  FOR j FROM 1 TO Dim(Result1,2) DO
    Write output, ValToStr(Result1{i,j})+" " \NoNewLine;
  ENDFOR
  Write output, " ";
ENDFOR
```

In the example above matrix A1 and matrix B1 are added, and the result is stored in matrix Result1. The content of Result1 is then written to a file. The output will be:

```
3 4
0 2
```

Example 2

```
VAR dnum A2{3, 3}:=[[1, 5, 0], [-4, 3, 9], [4, -3, 2]];
VAR dnum B2{3, 3}:=[[2, -1, -2], [4, -1, 2], [5, 8, 6]];
VAR dnum Result2{2, 2};
..
MatrixReset Result2;
MatrixAdd A2 \A_m:=2 \A_n:=2, B2, Result2;
FOR i FROM 1 TO Dim(Result2,1) DO
  FOR j FROM 1 TO Dim(Result2,2) DO
    Write output, ValToStr(Result2{i,j})+" " \NoNewLine;
  ENDFOR
  Write output, " ";
ENDFOR
```

In the example above matrix A2 and matrix B2 are added, and the result is stored in matrix Result2. Only 2 rows and 2 columns in the A2 and B2 matrices will be considered. The result matrix will be a 2*2 matrix and can be stored in the Result2 matrix. The content of Result2 is then written to a file. The output will be:

```
3 4
0 2
```

Arguments

```
MatrixAdd A [\A_m] [\A_n] B Result
```

Continues on next page

A

Data type: array of dnum

A is a matrix with the dimensions $m \times n$, where m is the number of rows, and n is the number of columns.

[\A_m]

Data type: num

With the optional argument A_m it is possible to specify how many of the rows (m) in the matrix A (and matrix B) that should be used.

[\A_n]

Data type: num

With the optional argument A_n it is possible to specify how many of the columns (n) in the matrix A (and matrix B) that should be used.

B

Data type: array of dnum

B is a matrix with the dimensions $m \times n$, where m is the number of rows, and n is the number of columns. The rows and columns of B must be at least as big as rows and columns in A, or the values used in optional arguments A_m and A_n .

Result

Data type: array of dnum

This is an array variable where the result of the calculation is stored, with the dimensions $m \times n$, where m is the number of rows, and n is the number of columns of the matrix. The rows and columns of Result must be at least as big as rows and columns in A, or the values used in optional arguments A_m and A_n .

Program execution

MatrixAdd is used to add one matrix to another matrix. A matrix can only be added to another matrix if the two matrices have the same dimensions, and the result will be a matrix with same dimensions as A.

Error handling

The following recoverable errors are generated and can be handled in an error handler. The system variable ERRNO will be set to:

ERR_ARRAY_SIZE	Wrong dimensions or wrong values on optional arguments are used.
----------------	--

Syntax

```
MatrixAdd
[ A := ] < array {*}{*} expression (IN) of dnum >
[ '\ A_m :=' < expression (IN) of num > ]
[ '\ A_n :=' < expression (IN) of num > ] ', '
[ B := ] < array {*}{*} expression (IN) of dnum > ', '
[ Result := ] < array variable {*}{*} (VAR) of dnum > ';'

```

Continues on next page

1 Instructions

1.132 MatrixAdd - Calculates the sum of two matrices

RobotWare Base

Continued

Related information

For information about	See
MatrixInverse	MatrixInverse - Inverse a matrix on page 361
MatrixMult	MatrixMult - Multiply two matrices or multiply matrix with scalar on page 364
MatrixReset	MatrixReset - Set all elements in a matrix to 0 on page 369
MatrixSub	MatrixSub - Calculates the difference between two matrices on page 376
MatrixTranspose	MatrixTranspose - Transpose a matrix on page 382
Mathematical instructions and functions.	Technical reference manual - RAPID Overview

1.133 MatrixInverse - Inverse a matrix

Usage

`MatrixInverse` is used to calculate the inverse a matrix. For non-square matrices, the instruction calculates the so called pseudo-inverse to the matrix.

Basic examples

The following examples illustrate the instruction `MatrixInverse`.

Example 1

```
VAR dnum A1{2,2}:=[[4, 7],
  [2, 6]];
VAR dnum Result1{2,2};
..
MatrixInverse A1, Result1;
FOR i FROM 1 TO Dim(Result1,1) DO
  FOR j FROM 1 TO Dim(Result1,2) DO
    Write output, ValToStr(Result1{i,j})+" " \NoNewLine;
  ENDFOR
  Write output, " ";
ENDFOR
Write output, " ";
```

In the example above the inverse of matrix `A1` is calculated and stored in matrix `Result1`. The content of `Result1` is then written to a file. The output will be:

```
0.6 -0.7
-0.2 0.4
```

Example 2

```
VAR dnum A3{7,4}:=[ [ 50, -72, 85, 66],
  [-49, -70, -30, 17],
  [ 1, -48, -60, 10],
  [ 40, 68, -50, 83],
  [ 78, -49, 23, -43],
  [ 91, 63, -5, 51],
  [ 9, -51, -30, 50]];
VAR dnum Result3{10,10};
VAR num ResM;
VAR num ResN;
..
MatrixInverse A3, Result3 \Result_m:=ResM \Result_n:=ResN;
TPWrite "Number of valid rows in Result3= "+ValToStr(ResM);
TPWrite "Number of valid columns in Result3= "+ValToStr(ResN);
FOR i FROM 1 TO ResM DO
  FOR j FROM 1 TO ResN DO
    Write output, ValToStr(RoundDnum(Result3{i,j} \Dec:=6)) + " "
      \NoNewLine;
  ENDFOR
  Write output, " ";
ENDFOR
```

Continues on next page

1 Instructions

1.133 MatrixInverse - Inverse a matrix

RobotWare Base

Continued

In the example above the inverse of matrix `A3` is calculated and stored in matrix `Result3`.

The dimensions of the `Result3` matrix are bigger than it must be, so we use optional arguments `Result_m` and `Result_n` to get resulting rows and columns, which can be used in the writing to the file. The output to the file will be:

Number of valid rows in `Result3`=4

Number of valid columns in `Result3`=7

```
-8.1E-5 -0.002044 0.002093 0.000785 0.006486 0.003943 0.000635
-0.002159 -0.002835 -0.003043 0.001814 -0.002848 0.001601 -0.002671
0.005524 -0.001825 -0.005426 -0.002353 -0.002046 -0.000923 -0.002497
0.004527 0.001812 -0.000683 0.00365 -0.004902 0.000855 0.002398
```

Arguments

```
MatrixInverse A [\A_m] [\A_n] Result [\Result_m] [\Result_n]
[\Tolerance]
```

`A`

Data type: array of dnum

`A` is a matrix with the dimensions $m \times n$, where m is the number of rows, and n is the number of columns of the matrix.

`[\A_m]`

Data type: num

With the optional argument `A_m` it is possible to specify how many of the rows (m) in the matrix `A` that should be used.

`[\A_n]`

Data type: num

With the optional argument `A_n` it is possible to specify how many of the columns (n) in the matrix `A` that should be used.

`Result`

Data type: array of dnum

This is an array variable where the result of the calculation is stored. If `A` is a $m \times n$ matrix, the `Result` matrix must be at least a $n \times m$ matrix.

`[\Result_m]`

Data type: num

The number of valid rows in the `Result` matrix.

`[\Result_n]`

Data type: num

The number of valid columns in the `Result` matrix.

`[\Tolerance]`

Data type: dnum

The default tolerance value without using this optional argument is $1.0e-6$.

Continues on next page

If using this optional argument, the value can be set between 0 and 1. The value sets the tolerance against a singular matrix. More specifically, the instruction will return `ERR_MATRIX_SINGULAR` if the reciprocal condition number of the input matrix is less than the provided tolerance. Lowering the tolerance can eliminate the error message. Be aware though that lowering the tolerance too much can cause the instruction to return a result with bad numerical accuracy.

Program execution

`MatrixInverse` is used to calculate the inverse of a matrix.

It is possible to specify that only parts of the matrix `A` should be used with the optional arguments `A_m` and `A_n`. If `A` is a $m \times n$ matrix, the `Result` matrix (inverted matrix) will be a $n \times m$ matrix.

For non-square matrices, the instruction calculates the so called pseudo-inverse to the matrix.

Error handling

The following recoverable errors are generated and can be handled in an error handler. The system variable `ERRNO` will be set to:

<code>ERR_ARRAY_SIZE</code>	Wrong values on optional arguments are used, or incorrect dimensions of used matrices.
<code>ERR_MATRIX_SINGULAR</code>	The input matrix is singular.

Syntax

```
MatrixInverse
[ A :=' ] < array {*}{*} expression (IN) of dnum >
[ '\ A_m :=' < expression (IN) of num > ]
[ '\ A_n :=' < expression (IN) of num > ] ', '
[ Result :=' ] < array variable {*}{*} (VAR) of dnum >
[ '\ Result_m :=' < variable (VAR) of num > ]
[ '\ Result_n :=' < variable (VAR) of num > ]
[ '\ Tolerance :=' < expression (IN) of dnum > ] ';'

```

Related information

For information about	See
<code>MatrixAdd</code>	MatrixAdd - Calculates the sum of two matrices on page 358
<code>MatrixMult</code>	MatrixMult - Multiply two matrices or multiply matrix with scalar on page 364
<code>MatrixReset</code>	MatrixReset - Set all elements in a matrix to 0 on page 369
<code>MatrixSub</code>	MatrixSub - Calculates the difference between two matrices on page 376
<code>MatrixTranspose</code>	MatrixTranspose - Transpose a matrix on page 382
Mathematical instructions and functions.	Technical reference manual - RAPID Overview

1 Instructions

1.134 MatrixMult - Multiply two matrices or multiply matrix with scalar

RobotWare Base

1.134 MatrixMult - Multiply two matrices or multiply matrix with scalar

Usage

`MatrixMult` is used to multiply two matrices or to multiply a matrix with a scalar.

Basic examples

The following examples illustrate the instruction `MatrixMult`.

See also [More examples on page 366](#).

Example 1

```
VAR dnum A1{3,2}:=[ [1, 3],
  [4, -1],
  [-5, 10]];
VAR dnum B1{2,2}:=[ [2, 1],
  [-8, 6]];
VAR dnum Result1{3,2};
..
MatrixMult A1, B1, Result1;
FOR i FROM 1 TO Dim(Result1,1) DO
  FOR j FROM 1 TO Dim(Result1,2) DO
    Write output, ValToStr(Result1{i,j})+" " \NoNewLine;
  ENDFOR
  Write output, ";
ENDFOR
```

In the example above matrix `A1` is multiplied with matrix `B1` and the result is stored in matrix `Result1`. The content of `Result1` is then written to a file. The output will be:

```
-22 19
16 -2
-90 55
```

Example 2

```
VAR dnum A1{3,2}:=[ [1, 3],
  [4, -1],
  [-5, 10]];
VAR dnum Result1{3,2};
..
MatrixMult A1, 2, Result1;
```

In the example above matrix `A1` is multiplied with a scalar `2`. The result is stored in matrix `Result1`. The content of `Result1` is:

```
[[2,6],
[8,-2],
[-10,20]];
```

Arguments

```
MatrixMult A [\A_m] [\A_n] Scalar | B [\B_m] [\B_n] Result
[\Result_m] [\Result_n]
```

Continues on next page

1.134 MatrixMult - Multiply two matrices or multiply matrix with scalar

RobotWare Base

Continued

A

Data type: array of dnum

A is a matrix with the dimensions $p \times q$, where p is the number of rows, and q is the number of columns.

[\A_m]

Data type: num

With the optional argument A_m it is possible to specify how many of the rows (m) in the matrix A that should be used.

[\A_n]

Data type: num

With the optional argument A_n it is possible to specify how many of the columns (n) in the matrix A that should be used.

Scalar

Data type: dnum

The numeric value used to multiply each element in the matrix A.

B

Data type: array of dnum

B is a matrix with the dimensions $q \times r$, where q is the number of rows, and r is the number of columns.

The requirement on the matrix B is that its number of rows must be equal or more than the number of columns in the matrix A.

[\B_m]

Data type: num

With the optional argument B_m it is possible to specify how many of the rows (m) in the matrix B that should be used.

[\B_n]

Data type: num

With the optional argument B_n it is possible to specify how many of the columns (n) in the matrix B that should be used.

Result

Data type: array of dnum

This is an array variable where the result of the calculation is stored. The requirements on dimensions of the matrix `Result` are:

- Multiplication with a scalar: the `Result` matrix must be equal or bigger than the dimensions of matrix A.
- Multiplication between a matrix A and matrix B: A is a $p \times q$ matrix, B is a $q \times r$ matrix, then `Result` must be at least a $p \times r$ matrix.

Example:

$A1\{3,2\} \times B1\{2,2\} \Rightarrow Result1\{3,2\}$

Continues on next page

1 Instructions

1.134 MatrixMult - Multiply two matrices or multiply matrix with scalar

RobotWare Base

Continued

$A2\{7,5\} \times B2\{5,2\} \Rightarrow \text{Result2}\{7,2\}$

`[\Result_m]`

Data type: num

The number of valid rows in the Result matrix.

`[\Result_n]`

Data type: num

The number of valid columns in the Result matrix.

Program execution

`MatrixMult` is used to multiply one matrix with a scalar or a matrix with another matrix.

It is possible to specify that only parts of the matrices should be used with the optional arguments `A_m`, `A_n`, `B_m`, and `B_n`, and you will get required dimensions of the result matrix in optional arguments `Result_m` and `Result_n`. See example 2 in [More examples on page 366](#) how parts of two matrices are used.

Error handling

The following recoverable errors are generated and can be handled in an error handler. The system variable `ERRNO` will be set to:

<code>ERR_ARRAY_SIZE</code>	Wrong dimensions or wrong values on optional arguments are used.
-----------------------------	--

More examples

Example 1

```
VAR dnum A2{7,5}:=[ [1, 3, 1, 2, 3],
  [4, -1, 1, 2, 3],
  [-5, 10, 1, 2, 3],
  [1, 2, 3, 4, 5],
  [1, 2, 3, 4, 5],
  [1, 2, 3, 4, 5],
  [1, 2, 3, 4, 5]];
VAR dnum B2{5,2}:=[ [2, 2],
  [2, 2],
  [2, 2],
  [2, 2],
  [2, 2]];
VAR dnum Result2{10,10};
VAR num Res_m;
VAR num Res_n;
..
MatrixReset Result2;
MatrixMult A2, B2, Result2 \Result_m:=Res_m \Result_n:=Res_n;
FOR i FROM 1 TO Res_m DO
  FOR j FROM 1 TO Res_n DO
    Write output, ValToStr(Result2{i,j})+" " \NoNewLine;
  ENDFOR
```

Continues on next page

1.134 MatrixMult - Multiply two matrices or multiply matrix with scalar

*RobotWare Base**Continued*

```

    Write output, "";
  ENDFOR

```

In the example above matrix `A2` is multiplied with matrix `B2` and the result is stored in matrix `Result2`. The dimensions of matrix `Result2` are bigger than it needs to be. In `Res_m` and `Res_n`, the number of valid rows and columns in the `Result2` matrix is returned and can be used when logging to file.

The output in the file will be:

```

20 20
18 18
22 22
30 30
30 30
30 30
30 30
30 30

```

Example 2

```

VAR dnum A1{5,5}:=[ [1, 3, -7, 4, 3.5],
  [4, -1, 1, 5, 3],
  [-5, 10, 0.5, 4, -3],
  [-5, 8, -2, 8, 0],
  [1.5, 3, 7, 4, -1]];
VAR dnum B1{4,4}:=[ [2, 1, -1, 0.5],
  [-8, 6, 3, -2],
  [3, -5, 2, -4],
  [1, 2, -2, 7]];
VAR dnum Result1{5,5};
VAR num Res_m;
VAR num Res_n;
..
MatrixReset Result1;
MatrixMult A1 \A_m:=3 \A_n:=2, B1 \B_m:=2 \B_n:=2, Result1
  \Result_m:=Res_m \Result_n:=Res_n;
Write output, "Res_m = "+ ValToStr(Res_m);
Write output, "Res_n = "+ ValToStr(Res_n);
FOR i FROM 1 TO Res_m DO
  FOR j FROM 1 TO Res_n DO
    Write output, ValToStr(Result1{i,j})+" " \NoNewLine;
  ENDFOR
  Write output, "";
ENDFOR

```

In the example above matrix `A1` is multiplied with matrix `B1` and the result is stored in matrix `Result1`. In matrix `A1` we use the first 3 rows and 2 columns (bold numbers) in the calculations, in matrix `B1` we use the first 2 rows and 2 columns in the calculation (bold numbers), and the valid data is stored in a 3*2 matrix in the `Result1` matrix.

The output in the file will be:

```

Res_m = 3

```

Continues on next page

1 Instructions

1.134 MatrixMult - Multiply two matrices or multiply matrix with scalar

RobotWare Base

Continued

```
Res_n = 2
-22 19
16 -2
-90 55
```

Syntax

```
MatrixMult
[ A := ] < array {*}{*} expression (IN) of dnum >
[ '\ A_m := < expression (IN) of num > ]
[ '\ A_n := < expression (IN) of num > ] ', '
[ Scalar := ] < expression (IN) of dnum >
| [ B := ] < array {*}{*} expression (IN) of dnum >
[ '\ B_m := < expression (IN) of num > ]
[ '\ B_n := < expression (IN) of num > ] ', '
[ Result := ] < array variable {*}{*} (VAR) of dnum >
[ '\ Result_m := < variable (VAR) of num > ]
[ '\ Result_n := < variable (VAR) of num > ] ';' ;'
```

Related information

For information about	See
MatrixAdd	MatrixAdd - Calculates the sum of two matrices on page 358
MatrixInverse	MatrixInverse - Inverse a matrix on page 361
MatrixReset	MatrixReset - Set all elements in a matrix to 0 on page 369
MatrixSub	MatrixSub - Calculates the difference between two matrices on page 376
MatrixTranspose	MatrixTranspose - Transpose a matrix on page 382
Mathematical instructions and functions.	Technical reference manual - RAPID Overview

1.135 MatrixReset - Set all elements in a matrix to 0

Usage

`MatrixReset` is used to set all elements in a matrix to zero (0).

Basic examples

The following examples illustrate the instruction `MatrixReset`.

Example 1

```
VAR dnum A1{7,5}
..
MatrixReset A1;
```

In the example above all elements in `A1` are set to 0.

Example 2

```
VAR dnum A1{7,5}
..
MatrixReset A1 \A_m:=3 \A_n:=4;
```

In the example above 3 rows and 4 columns of the `A1` matrix are set to 0.

Arguments

```
MatrixReset A [\A_m] [\A_n]
```

`A`

Data type: array of `dnum`

`A` is a matrix with the dimensions $m*n$, where `m` is the number of rows, and `n` is the number of columns.

`[\A_m]`

Data type: `num`

With the optional argument `A_m` it is possible to specify how many of the rows (`m`) in the matrix `A` that should be used.

`[\A_n]`

Data type: `num`

With the optional argument `A_n` it is possible to specify how many of the columns (`n`) in the matrix `A` that should be used.

Program execution

`MatrixReset` is used to set all or some elements in a matrix to 0.

Error handling

The following recoverable errors are generated and can be handled in an error handler. The system variable `ERRNO` will be set to:

<code>ERR_ARRAY_SIZE</code>	Wrong values on optional arguments are used.
-----------------------------	--

Continues on next page

1 Instructions

1.135 MatrixReset - Set all elements in a matrix to 0

RobotWare Base

Continued

Syntax

```
MatrixReset  
[ A ':=' ] < array {*}{*} expression (IN) of dnum >  
[ '\ ' A_m ':=' < expression (IN) of num > ]  
[ '\ ' A_n ':=' < expression (IN) of num > ] ';' 
```

Related information

For information about	See
MatrixAdd	MatrixAdd - Calculates the sum of two matrices on page 358
MatrixInverse	MatrixInverse - Inverse a matrix on page 361
MatrixMult	MatrixMult - Multiply two matrices or multiply matrix with scalar on page 364
MatrixSub	MatrixSub - Calculates the difference between two matrices on page 376
MatrixTranspose	MatrixTranspose - Transpose a matrix on page 382
Mathematical instructions and functions.	Technical reference manual - RAPID Overview

1.136 MatrixSolve - Solve a linear equation system

Usage

`MatrixSolve` is used to solve linear equation systems on the form $A*x=b$.

Basic examples

The following examples illustrate the instruction `MatrixSolve`.

See also [More examples on page 372](#).

Example 1

```
VAR dnum A1{3,3}:=[[5, 2, 7],[-3, 1, 1],[1, 10, -3]];
VAR dnum b1{3}:=[-22, 39, 54];
VAR dnum x1{3};
...
MatrixSolve A1, b1, x1;
```

The example above solves the linear equation system. The `x1` array will have the value [-10, 7, 2].

Example 2

```
VAR dnum A2{1,1} := [[5]];
VAR dnum b2{1}:=[35];
VAR dnum x2{1};
...
MatrixSolve A2, b2, x2;
```

The example above solves the trivial equation $5x = 35$. The answer is 7.

Arguments

`MatrixSolve A [$\backslash A_m$] [$\backslash A_n$] b x`

A

Data type: array of dnum

A is a matrix with the dimensions $m * n$, where $m \geq n$. The letter m describes the number of rows, and letter n describes the number of columns of the matrix. If $m > n$, then the system of equations is overdetermined and a least-squares solution is returned.

[$\backslash A_m$]

Data type: num

With the optional argument $\backslash A_m$ it is possible to specify how many of the rows (m) in the matrix A that should be used.

[$\backslash A_n$]

Data type: num

With the optional argument $\backslash A_n$ it is possible to specify how many of the columns (n) in the matrix A that should be used.

b

Data type: array of dnum

Continues on next page

1 Instructions

1.136 MatrixSolve - Solve a linear equation system

RobotWare Base

Continued

b is an array with the same dimension as the rows (m) of the matrix A . If using an array with bigger dimension than the rows (m) of matrix A , the components above m will be set to 0.

x

Data type: array of dnum

x is an array with the same dimension as the columns (n) of the matrix A . This is an array variable where the result of the calculation is stored. If using an array with bigger dimension than the columns (n) of matrix A , the components above n will be set to 0.

Program execution

`MatrixSolve` is used to solve linear equation systems on the form $A \cdot x = b$. If the system is overdetermined, then a least-squares solution is returned.

If using the optional arguments A_m and A_n it is possible to use the same matrix for many different calculations that use different sizes of the matrix.

Error handling

The following recoverable errors are generated and can be handled in an error handler. The system variable `ERRNO` will be set to:

<code>ERR_ARRAY_SIZE</code>	Wrong dimensions or wrong values on optional arguments are used.
<code>ERR_MATRIX_SINGULAR</code>	The input matrix is singular.

More examples

More examples of the function `MatrixSolve` are illustrated below.

Example 1

```
VAR dnum A1{5,5}:=[[5,2,7,0,0], [-3,1,1,0,0], [1,10,-3,0,0]];
VAR dnum b1{8}:=[-22,39,54,0,0,0,0,0];
VAR dnum x1{8};
```

```
MatrixSolve A1 \A_m:=3 \A_n:=3, b1, x1;
```

The example above solves the linear equation system. The $x1$ array will have the value $[-10, 7, 2, 0, 0, 0, 0, 0]$. This example is the same as [Example 1 on page 371](#). The only difference is that in this example it is illustrated how to use the optional arguments A_m and A_n and that bigger arrays than m and n can be used for arguments b and x . A_m and A_n can be used to limit the size of the matrix, so a big general matrix can be used to solve many different equation systems.

Limitations

When solving large matrixes the allocated memory may not be enough to complete the current calculation and an event log is reported. The allocated memory size is fixed and cannot be changed. Try solving smaller sizes of the matrix.

Continues on next page

Syntax

MatrixSolve

```
[ A ' := ' ] < array {*}{*} expression (IN) of dnum >
[ '\ ' A_m ' := ' < expression (IN) of num > ]
[ '\ ' A_n ' := ' < expression (IN) of num > ] ', '
[ b ' := ' ] < array {*} expression (IN) of dnum > ', '
[ x ' := ' ] < array variable {*} (VAR) of dnum > ';'

```

Related information

For information about	See
Compute a QR-factorization.	MatrixSolveQR - Computes a QR-factorization on page 374
Compute a singular value decomposition.	MatrixSVD - Computes a singular value decomposition on page 379
Mathematical instructions and functions.	<i>Technical reference manual - RAPID Overview</i>

1 Instructions

1.137 MatrixSolveQR - Computes a QR-factorization

RobotWare Base

1.137 MatrixSolveQR - Computes a QR-factorization

Usage

MatrixSolveQR is used to compute a QR-factorization of an (m x n) matrix A.

Basic examples

The following example illustrates the instruction MatrixSolveQR.

Example 1

```
VAR dnum A4{3,3}:=[[12,-51,4], [6,167,-68], [-4,24,-41]];
VAR dnum Q4{3,3};
VAR dnum R4{3,3};
MatrixSolveQR A4, Q4, R4;
```

Instruction MatrixSolveQR is used to compute a QR-factorization of an (m x n) matrix A4. The result of the calculation is:

```
Q4 := [[-0.857142857142857,0.394285714285714,0.331428571428571],
        [-0.428571428571429,-0.902857142857143,-0.0342857142857143],
        [0.285714285714286,-0.171428571428571,0.942857142857143]];
```

```
R4 := [[-14,-21,14], [0,-175,70], [0,0,-35]];
```

Arguments

MatrixSolveQR A [$\backslash A_m$] [$\backslash A_n$] Q R

A

Data type: array of dnum

A is a matrix with the dimensions m * n, where m is the number of rows, and n is the number of columns.

[$\backslash A_m$]

Data type: num

With the optional argument A_m it is possible to specify how many of the rows m in the matrix A that shall be used.

[$\backslash A_n$]

Data type: num

With the optional argument A_n it is possible to specify how many of the columns n in the matrix A that shall be used.

Q

Data type: array of dnum

Orthogonal (m x m) matrix. This is a matrix variable where the result of the calculation is stored.

R

Data type: array of dnum

(m x n) upper-triangular matrix. This is a matrix variable where the result of the calculation is stored.

Continues on next page

Program execution

`MatrixSolveQR` computes a QR-factorization of an (m x n) matrix *A* so that $A=Q*R$, where *Q* is an (m x m) orthogonal matrix and *R* is an (m x n) upper triangular matrix.

If using the optional arguments `A_m` and `A_n` it is possible to use the same matrix for many different calculations that use different sizes of the matrix.

Error handling

The following recoverable errors are generated and can be handled in an error handler. The system variable `ERRNO` will be set to:

<code>ERR_ARRAY_SIZE</code>	Wrong dimensions or wrong values on optional arguments are used.
-----------------------------	--

Limitations

When solving large matrixes the allocated memory may not be enough to complete the current calculation and an event log is reported. The allocated memory size is fixed and cannot be changed. Try solving smaller sizes of the matrix.

Syntax

```
MatrixSolveQR
[ A := ] < array {*}{*} expression (IN) of dnum >
[ '\ A_m := < expression (IN) of num > ]
[ '\ A_n := < expression (IN) of num > ] ', '
[ Q := ] < array variable {*}{*} (VAR) of dnum > ', '
[ R := ] < array variable {*}{*} (VAR) of dnum > ';'

```

Related information

For information about	See
Solve a linear equation system.	MatrixSolve - Solve a linear equation system on page 371
Compute a singular value decomposition.	MatrixSVD - Computes a singular value decomposition on page 379
Mathematical instructions and functions.	<i>Technical reference manual - RAPID Overview</i>

1 Instructions

1.138 MatrixSub - Calculates the difference between two matrices

RobotWare Base

1.138 MatrixSub - Calculates the difference between two matrices

Usage

`MatrixSub` is used to calculate the difference of two matrices.

Basic examples

The following examples illustrate the instruction `MatrixSub`.

Example 1

```
VAR dnum A1{2, 2}:=[[1, 5], [-4, 3]];
VAR dnum B1{2, 2}:=[[2, -1], [4, -1]];
VAR dnum Result1{2, 2};
..
MatrixSub A1, B1, Result1;
FOR i FROM 1 TO Dim(Result1,1) DO
  FOR j FROM 1 TO Dim(Result1,2) DO
    Write output, ValToStr(Result1{i,j})+" " \NoNewLine;
  ENDFOR
  Write output, "";
ENDFOR
```

In the example above values in B1 matrix is subtracted from the values in A1 matrix and the result is stored in matrix `Result1`. The content of `Result1` is then written to a file. The output will be:

```
-1 6
-8 4
```

Example 2

```
VAR dnum A2{3, 3}:=[[1, 5, 0], [-4, 3, 9], [4, -3, 2]];
VAR dnum B2{3, 3}:=[[2, -1, -2], [4, -1, 2], [5, 8, 6]];
VAR dnum Result2{2, 2};
..
MatrixReset Result2;
MatrixSub A2 \A_m:=2 \A_n:=2, B2, Result2;
FOR i FROM 1 TO Dim(Result2,1) DO
  FOR j FROM 1 TO Dim(Result2,2) DO
    Write output, ValToStr(Result2{i,j})+" " \NoNewLine;
  ENDFOR
  Write output, "";
ENDFOR
```

In the example above values in B1 matrix is subtracted from the values in A1 matrix and the result is stored in matrix `Result2`. Only 2 rows and 2 columns in the A2 and B2 matrices will be considered. The result matrix will be a 2*2 matrix and can be stored in the `Result2` matrix. The content of `Result2` is then written to a file. The output will be:

```
-1 6
-8 4
```

Continues on next page

1.138 MatrixSub - Calculates the difference between two matrices

RobotWare Base

Continued

ArgumentsMatrixSub A [\backslash A_m] [\backslash A_n] B Result

A

Data type: array of dnumA is a matrix with the dimensions $m \times n$, where m is the number of rows, and n is the number of columns of the matrix.[\backslash A_m]**Data type:** numWith the optional argument A_m it is possible to specify how many of the rows (m) in the matrix A (and matrix B) that should be used.[\backslash A_n]**Data type:** numWith the optional argument A_n it is possible to specify how many of the columns (n) in the matrix A (and matrix B) that should be used.

B

Data type: array of dnumB is a matrix with the dimensions $m \times n$, where m is the number of rows, and n is the number of columns of the matrix. The rows and columns of B must be at least as big as rows and columns in A, or the values used in optional arguments A_m and A_n.

Result

Data type: array of dnumThis is an array variable where the result of the calculation is stored, with the dimensions $m \times n$, where m is the number of rows, and n is the number of columns of the matrix. The rows and columns of Result must be at least as big as rows and columns in A, or the values used in optional arguments A_m and A_n.**Program execution**

MatrixSub is used to subtract a matrix from another matrix. A matrix can only be subtracted from another matrix if the two matrices have the same dimensions, and the result will be a matrix with same dimensions as A.

Error handling

The following recoverable errors are generated and can be handled in an error handler. The system variable ERRNO will be set to:

ERR_ARRAY_SIZE	Wrong dimensions or wrong values on optional arguments are used.
----------------	--

Syntax

```
MatrixSub
[ A ::= ] < array {*}{*} expression (IN) of dnum >
[ '\ A_m ::= ' < expression (IN) of num > ]
[ '\ A_n ::= ' < expression (IN) of num > ] ','
```

Continues on next page

1 Instructions

1.138 MatrixSub - Calculates the difference between two matrices

RobotWare Base

Continued

```
[ B ':=' ] < array {*}{*} expression (IN) of dnum >  
[ Result ':=' ] < array variable {*}{*} (VAR) of dnum > ';' 
```

Related information

For information about	See
MatrixAdd	MatrixAdd - Calculates the sum of two matrices on page 358
MatrixInverse	MatrixInverse - Inverse a matrix on page 361
MatrixMult	MatrixMult - Multiply two matrices or multiply matrix with scalar on page 364
MatrixReset	MatrixReset - Set all elements in a matrix to 0 on page 369
MatrixTranspose	MatrixTranspose - Transpose a matrix on page 382
Mathematical instructions and functions.	Technical reference manual - RAPID Overview

1.139 MatrixSVD - Computes a singular value decomposition

Usage

MatrixSVD is used to compute a singular value decomposition (SVD).

The singular value decomposition (SVD) is a factorization of a real matrix, with many useful applications in signal processing and statistics.

Basic examples

The following example illustrates the instruction MatrixSVD.

Example 1

```

VAR dnum A3{7,5}:=[[32,5,30,-47,16], [41,46,-36,35,-33],
                 [-38,47,-8,44,21], [42,-35,42,18,-47], [13,48,30,26,-23],
                 [-41,46,46,25,-46], [-22,-1,16,-11,-41]];
VAR dnum U3{7,7};
VAR dnum S3{5};
VAR dnum V3{5,5};

```

```

MatrixSVD A3, U3, S3, V3;

```

Instruction MatrixSVD is used to compute a singular value decomposition. The result of the calculation is:

```

U3 := [ [-0.24489453114765, -0.241308890179438, -0.0602284681243788,
        -0.835993641906923, -0.0767894261551876, 0.240015157740137,
        0.340264541994411], [0.36884312087718, -0.011165754164993,
        0.807113814553714, -0.0174513269190971, -0.383355889416929,
        0.231289898525022, 0.107870591684966], [0.421298684810973,
        0.496825721418653, -0.0754892815524551, -0.0380766666594926,
        0.433352499740395, 0.0439085586237023, 0.615467956914505],
        [0.026022505267863, -0.748510046516493, 0.145750281133738,
        0.297910761636627, 0.491463032720705, 0.125969427524946,
        0.267688931284032], [0.44990665677733, -0.194363365765786,
        0.11415708386435, -0.406351234561054, 0.210650943912061,
        -0.684691075563818, -0.261683066861719], [0.634107267122289,
        -0.191796131356257, -0.458818389285907, -0.058536500937226,
        -0.126605540694026, 0.499569153226195, -0.285627519159172],
        [0.145957672500732, -0.24490688904148, -0.307330264960591,
        0.205089199291144, -0.597836567476733, -0.390807165865741,
        0.521598216836665]];

```

```

S3 := [128.223078192708, 106.345877681972, 86.7728210622664,
       62.5176992467654, 42.2777876032412];

```

```

V3 := [ [-0.241697068016687, -0.449209801318353, 0.774566517264602,
        -0.334347996967586, 0.16748495146732], [0.664865161158152,
        0.281358669789186, 0.148180746944642, -0.633450002424302,
        -0.235743880251818], [0.172346698575578, -0.571920245958167,
        -0.538598865014224, -0.371678506044732, 0.463648787880432],
        [0.541008847671309, 0.114564782377902, 0.291104463782398,
        0.449207178575608, 0.638479004558623], [-0.420883460142759,
        0.61549167032206, -0.0570844141501356, -0.383432536716582,
        0.541985217686462]];

```

Continues on next page

1 Instructions

1.139 MatrixSVD - Computes a singular value decomposition

RobotWare Base

Continued

Arguments

MatrixSVD A [$\backslash A_m$] [$\backslash A_n$] U S V [$\backslash Econ$]

A

Data type: array of dnum

A is a matrix with the dimensions $m * n$, where m is the number of rows, and n is the number of columns.

[$\backslash A_m$]

Data type: num

With the optional argument A_m it is possible to specify how many of the rows m in the matrix A that shall be used.

[$\backslash A_n$]

Data type: num

With the optional argument A_n it is possible to specify how many of the columns n in the matrix A that shall be used.

U

Data type: array of dnum

U is the left singular vectors of A, stored as an $m \times kk$ matrix, where kk is equal to the columns of the A matrix (or A_n) if the $\backslash Econ$ switch is used, otherwise it is the same as the rows of the A matrix (or A_m). This is a matrix variable where the result of the calculation is stored. If using a matrix with bigger dimension than the rows (m) and columns (n) of matrix A, the components above m and n will be set to 0.

S

Data type: array of dnum

S is an array with the dimension $\text{MIN}(A_m, A_n)$ with values ≥ 0 . This is an array variable where the result of the calculation is stored. If using an array with bigger dimension than needed, the components above n will be set to 0.

V

Data type: array of dnum

V is the right singular vectors of A stored as a $n \times n$ matrix.

[$\backslash Econ$]

(Economy size)

Data type: switch

If $\backslash Econ$ is used and $m > n$, then only the n first singular vectors of U are calculated.

Program execution

MatrixSVD is used to compute a singular value decomposition (SVD) of the ($m \times n$) input matrix A.

An SVD of a matrix A can be written as $A=U*S*V^T$, where U is ($m \times m$) (left singular vectors), V is ($n \times n$) (right singular vectors) and S is an ($m \times n$) diagonal matrix with non-negative elements. The diagonal elements are the singular values of A.

Continues on next page

To save space, only the singular values of S are returned, and not the complete matrix. So S is represented as an array of length $\text{MIN}(m, n)$. The singular values are always returned in decreasing order.

With $m > n$, further space can be saved by only computing the n first singular vectors of U . This is controlled by using the switch `\Econ`. Hence, if $m > n$ and `\Econ` is used, then U is $(m \times n)$, otherwise U is $(m \times m)$.

If using the optional arguments `A_m` and `A_n` it is possible to use the same matrix for many different calculations that use different sizes of the matrix.

Error handling

The following recoverable errors are generated and can be handled in an error handler. The system variable `ERRNO` will be set to:

<code>ERR_ARRAY_SIZE</code>	Wrong dimensions or wrong values on optional arguments are used.
-----------------------------	--

Limitations

When solving large matrixes the allocated memory may not be enough to complete the current calculation and an event log is reported. The allocated memory size is fixed and cannot be changed. Try solving smaller sizes of the matrix.

Syntax

```
MatrixSVD
[ A :=' ] < array {*}{*} expression (IN) of dnum >
[ '\ A_m :=' < expression (IN) of num > ]
[ '\ A_n :=' < expression (IN) of num > ] ', '
[ U :=' ] < array variable {*}{*} (VAR) of dnum > ', '
[ S :=' ] < array variable {*} (VAR) of dnum > ', '
[ V :=' ] < array variable {*}{*} (VAR) of dnum >
[ '\ Econ ] ';'

```

Related information

For information about	See
Solve a linear equation system.	MatrixSolve - Solve a linear equation system on page 371
Compute a QR-factorization	MatrixSolveQR - Computes a QR-factorization on page 374
Mathematical instructions and functions.	Technical reference manual - RAPID Overview

1 Instructions

1.140 MatrixTranspose - Transpose a matrix *RobotWare Base*

1.140 MatrixTranspose - Transpose a matrix

Usage

`MatrixTranspose` calculates the transpose of a matrix.

Basic examples

The following examples illustrate the instruction `MatrixTranspose`.

Example 1

```
VAR dnum A1{3,2}:=[[1, 2], [3, 4], [5, 6]];
VAR dnum Result1{2,3};
..
MatrixTranspose A1, Result1;
FOR i FROM 1 TO Dim(Result1,1) DO
  FOR j FROM 1 TO Dim(Result1,2) DO
    Write output, ValToStr(Result1{i,j})+" " \NoNewLine;
  ENDFOR
  Write output, ";
ENDFOR
```

In the example above a transpose of matrix `A1` is done and the result is stored in matrix `Result1`. The content of `Result1` is then written to a file. The output will be:

```
1 3 5
2 4 6
```

Example 2

```
VAR dnum A3{4,3}:=[[1, 2, -1], [3, 4, -2], [5, 6, -3], [7, 8, -4]];
VAR dnum Result3{10,10};
VAR num ResM;
VAR num ResN;
MatrixTranspose A3 \A_m:=3 \A_n:=2, Result3 \Result_m:=ResM
\Result_n:=ResN;
FOR i FROM 1 TO ResM DO
  FOR j FROM 1 TO ResN DO
    Write output, ValToStr(Result3{i,j})+" " \NoNewLine;
  ENDFOR
  Write output, ";
ENDFOR
```

In the example above a transpose of matrix `A3` is done and the result is stored in matrix `Result3`. Only the 3 first rows and 2 first columns in the `A3` matrix should be considered. In `ResM` and `ResN`, the number of valid rows and columns in the `Result3` matrix is returned and can be used when logging to file. The content of `Result3` is then written to a file. The output will be:

```
1 3 5
2 4 6
```

Arguments

`MatrixTranspose A [\A_m] [\A_n] Result [\Result_m] [\Result_n]`

Continues on next page

A

Data type: array of dnum

A is a matrix with the dimensions $m \times n$, where m is the number of rows, and n is the number of columns of the matrix.

[\A_m]

Data type: num

With the optional argument A_m it is possible to specify how many of the rows (m) in the matrix A that should be used.

[\A_n]

Data type: num

With the optional argument A_n it is possible to specify how many of the columns (n) in the matrix A that should be used.

Result

Data type: array of dnum

This is an array variable where the result of the calculation is stored. This matrix is often called A^T . If A is a $m \times n$ matrix, the Result matrix must be at least a $n \times m$ matrix.

[\Result_m]

Data type: num

The number of valid rows in the Result matrix.

[\Result_n]

Data type: num

The number of valid columns in the Result matrix.

Program execution

MatrixTranspose is used to transpose a matrix. This function flips the matrix over its diagonal, it switches the row and column indices of the matrix A by producing another matrix, often denoted by A^T .

It is possible to specify that only parts of the matrix A should be used with the optional arguments A_m and A_n .

If A is a $m \times n$ matrix, the Result matrix (transpose matrix) will be a $n \times m$ matrix.

Error handling

The following recoverable errors are generated and can be handled in an error handler. The system variable ERRNO will be set to:

ERR_ARRAY_SIZE	Wrong values on optional arguments are used, or incorrect dimensions of used matrices.
----------------	--

Syntax

```
MatrixTranspose
[ A ':=' ] < array {*}{*} expression (IN) of dnum >
[ '\ A_m ':=' < expression (IN) of num > ]
```

Continues on next page

1 Instructions

1.140 MatrixTranspose - Transpose a matrix

RobotWare Base

Continued

```
[ '\ A_n ' := ' < expression (IN) of num > ] ', '  
[ Result := ' ] < array variable {*}{*} (VAR) of dnum >  
[ '\ Result_m := ' < variable (VAR) of num > ]  
[ '\ Result_n := ' < variable (VAR) of num > ] ;'
```

Related information

For information about	See
MatrixAdd	MatrixAdd - Calculates the sum of two matrices on page 358
MatrixInverse	MatrixInverse - Inverse a matrix on page 361
MatrixMult	MatrixMult - Multiply two matrices or multiply matrix with scalar on page 364
MatrixReset	MatrixReset - Set all elements in a matrix to 0 on page 369
MatrixSub	MatrixSub - Calculates the difference between two matrices on page 376
Mathematical instructions and functions.	Technical reference manual - RAPID Overview

1.141 MechUnitLoad - Defines a payload for a mechanical unit

Usage

`MechUnitLoad` is used to define a payload for an external mechanical unit, for example positioners. The payload for a robot is defined with the instruction `GripLoad`.

This instruction should be used for all mechanical units with dynamic model (ABB positioners and track motions) to achieve the best motion performance.

The `MechUnitLoad` instruction should always be executed after execution of the instruction `ActUnit`.

This instruction can only be used in the main task `T_ROB1` or, if in a *MultiMove* system, in Motion tasks.

Description

`MechUnitLoad` specifies which loads the mechanical unit are carrying. Specified loads are used in the control system so that the movements of the mechanical unit can be controlled in the best possible way.

The payload is connected/disconnected using the instruction `MechUnitLoad`, which adds or subtracts the weight of the payload to the weight of the mechanical unit.



WARNING

It is important to always define the actual tool load and, when used, the payload of the robot (for example, a gripped part). Incorrect definitions of load data can result in overloading of the robot mechanical structure. There is also a risk that the speed in manual reduced speed mode can be exceeded.

When incorrect load data is specified, it can often lead to the following consequences:

- The robot may not use its maximum capacity.
- Impaired path accuracy including a risk of overshooting.
- Risk of overloading the mechanical structure.

The controller continuously monitors the load and writes an event log if the load is higher than expected. This event log is saved and logged in the controller memory.



WARNING

The above warning also applies when defining payloads for an external mechanical unit.

Continues on next page

1 Instructions

1.141 MechUnitLoad - Defines a payload for a mechanical unit

RobotWare Base

Continued

Basic examples

The following examples illustrate the instruction `MechUnitLoad`:

Illustration

The following figure shows axis 1 on a mechanical unit named `STN1` of type `IRBPL`.

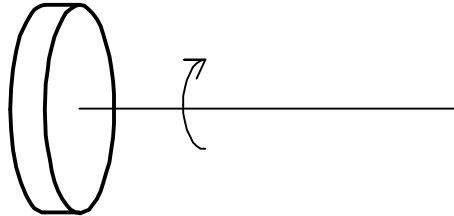

xx0500002142

Example 1

```
ActUnit STN1;  
MechUnitLoad STN1, 1, load0;
```

Activate mechanical unit `STN1` and define the payload `load0` corresponding to no load (at all) mounted on axis 1.

Example 2

```
ActUnit STN1;  
MechUnitLoad STN1, 1, fixture1;
```

Activate mechanical unit `STN1` and define the payload `fixture1` corresponding to the fixture mounted on axis 1.

Example 3

```
ActUnit STN1;  
MechUnitLoad STN1, 1, workpiece1;
```

Activate mechanical unit `STN1` and define the payload `workpiece1` corresponding to fixture and work piece mounted on axis 1.

Arguments

```
MechUnitLoad MechUnit AxisNo Load
```

`MechUnit`

Mechanical Unit

Data type: `mecunit`

The name of the mechanical unit.

`AxisNo`

Axis Number

Data type: `num`

The axis number within the mechanical unit that holds the load. Axis numbering starts from 1.

`Load`

Data type: `loaddata`

Continues on next page

The load data that describes the current payload to be defined, that is, the fixture or the fixture together with work piece depending on if the work piece is mounted on the mechanical unit or not.

Program execution

The specified load applies for the next executed movement instruction until a new `MechUnitLoad` instruction is executed.

After execution of `MechUnitLoad`, when the robot and additional axes have come to a standstill, the specified load is defined for the specified mechanical unit and axis. This means that the payload is controlled and monitored by the control system.

The default payload when using the restart mode **Reset system** for a certain mechanical unit type, is the predefined maximal payload for this mechanical unit type.

When another payload is used, the actual payload for the mechanical unit and axis should be redefined with this instruction. This should always be done after activation of the mechanical unit.

The defined payload will survive a restart. The defined payload will also survive a restart of the program after manual activation of other mechanical units from the jogging window.

The following graphic shows a payload mounted on the end-effector of a mechanical unit (end-effector coordinate system for the mechanical unit).

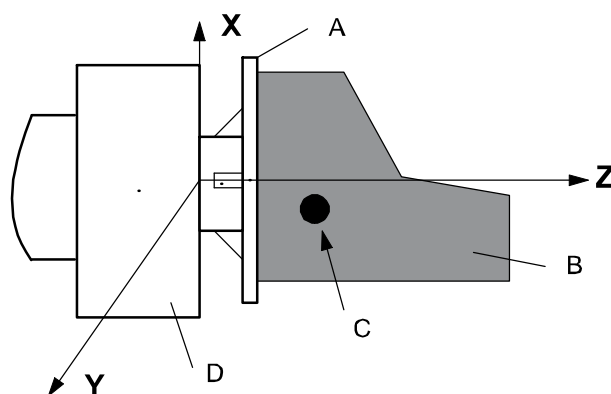

xx0500002143

A	End-effector
B	Fixture and work piece
C	Center of gravity for the payload (fixture + work piece)
D	Mechanical unit

Continues on next page

1 Instructions

1.141 MechUnitLoad - Defines a payload for a mechanical unit

RobotWare Base

Continued

More examples

More examples of how to use the instruction `MechUnitLoad` are illustrated below.

Illustration

The following figure shows a mechanical unit named `INTERCH` of type `IRBP K` with three axes (1, 2, and 3).

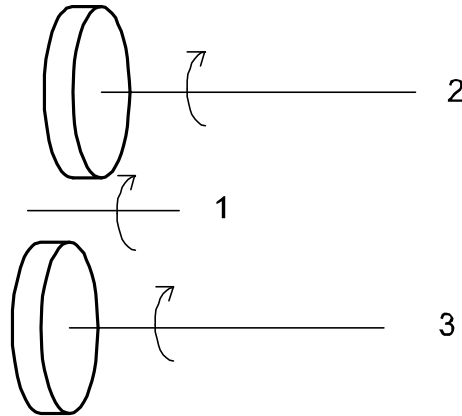

xx0500002144

Example 1

```
MoveL homeside1, v1000, fine, gun1;  
...  
ActUnit INTERCH;
```

The whole mechanical unit `INTERCH` is activated.

Example 2

```
MechUnitLoad INTERCH, 2, workpiece1;
```

Defines payload `workpiece1` on the mechanical unit `INTERCH` axis 2.

Example 3

```
MechUnitLoad INTERCH, 3, workpiece2;
```

Defines payload `workpiece2` on the mechanical unit `INTERCH` axis 3.

Example 4

```
MoveL homeside2, v1000, fine, gun1;
```

The axes of the mechanical unit `INTERCH` move to the switch position `homeside2` with mounted payload on both axes 2 and 3.

Example 5

```
ActUnit STN1;  
MechUnitLoad STN1, 1, workpiece1;
```

The mechanical unit `STN1` is activated. Defines payload `workpiece1` on the mechanical unit `STN1` axis 1.

Limitations

If this instruction is preceded by a move instruction, that move instruction must be programmed with a stop point (`zonedata fine`), not a fly-by point. Otherwise restart after power failure will not be possible.

Continues on next page

1.141 MechUnitLoad - Defines a payload for a mechanical unit

*RobotWare Base**Continued*

MechUnitLoad cannot be executed in a RAPID routine connected to any of the following special system events: PowerOn, Stop, QStop, Restart or Step.

Syntax

```
MechUnitLoad
  [MechUnit ':= ' ] <variable (VAR) of mecunit> ', '
  [AxisNo ':= ' ] <expression (IN) of num> ', '
  [Load ':= ' ] <persistent (PERS) of loaddata> ';'

```

Related information

For information about	See
Identification of payload for external mechanical units	<i>Product manual - Product.ProductName /D2009</i>
Definition of mechanical unit data	mecunit - Mechanical unit on page 1690
Definition of load data	loaddata - Load data on page 1682
Define payload for the robot	GripLoad - Defines the payload for a robot on page 243

1 Instructions

1.142 MotionProcessModeSet - Set motion process mode

Advanced Robot Motion

1.142 MotionProcessModeSet - Set motion process mode

Usage

`MotionProcessModeSet` is used to set the motion process mode (*Motion Process Mode*) for a TCP robot.

This instruction can only be used in the main task `T_ROB1` or, if in a *MultiMove* system, in any motion tasks.

Basic examples

The following example illustrates the instruction `MotionProcessModeSet`:

```
MotionProcessModeSet OPTIMAL_CYCLE_TIME_MODE;
! Do cycle-time critical movement
..
MotionProcessModeSet ACCURACY_MODE;
! Do cutting with high accuracy
..
```

Changing the motion process mode used for the TCP robot in run time.

Arguments

`MotionProcessModeSet Mode`

Mode

Data type: `motionprocessmode`

The motion process mode to be used. It is an integer constant of data type `motionprocessmode`.

Program execution

The motion process mode applies for the TCP robot until a new `MotionProcessModeSet` instruction is executed, see [Related information on page 391](#).

The default configured value for motion process mode is automatically set:

- when using the restart mode **Reset RAPID**
- when loading a new program or a new module
- when starting program execution from the beginning
- when moving the program pointer to `main`
- when moving the program pointer to a routine
- when moving the program pointer in such a way that the execution order is lost.

Continues on next page

Predefined data

The following symbolic constants of the data type `motionprocessmode` are predefined and can be used to specify the integer in argument `Mode`.

The default mode is defined by the system parameter *Use Motion Process Mode* in type *Robot*, topic *Motion*.

Symbolic constant	Constant value	Description
OPTIMAL_CYCLE_TIME_MODE	1	This mode gives the shortest possible cycle time.
LOW_SPEED_ACCURACY_MODE	2	This mode improves path accuracy mainly for large robots.
LOW_SPEED_STIFF_MODE	3	This mode is recommended for low speed contact applications where maximum servo stiffness is important.
ACCURACY_MODE	4	This mode improves path accuracy mainly for small robots.
MPM_USER_MODE_1	5	User defined modes.
MPM_USER_MODE_2	6	
MPM_USER_MODE_3	7	
MPM_USER_MODE_4	8	
PRESS_TENDING_MODE	9	Primarily intended for flexible grippers in press tending applications.

Limitations

The mode can only be changed when the robot is standing still, otherwise a fine point is enforced.

Syntax

```
MotionProcessModeSet
  [Mode ':='] <expression (IN) of motionprocessmode>;'
```

Related information

For information about	See
<i>Advanced robot motion</i>	<i>Application manual - Controller software IRC5</i>
Configuration of <i>Motion Process Mode</i> parameters.	<i>Technical reference manual - System parameters</i>
Tuning servos.	TuneServo - Tuning servos on page 985

1 Instructions

1.143 MotionSup - Deactivates/Activates motion supervision *Collision Detection*

1.143 MotionSup - Deactivates/Activates motion supervision

Usage

`MotionSup` (*Motion Supervision*) is used to deactivate or activate the motion supervision function for robot movements during program execution.

This instruction can only be used in the main task `T_ROB1` or, if in a *MultiMove* system, in Motion tasks.

Description

Motion supervision is the name of a collection of functions for high sensitivity, model-based supervision of the robot. It contains the function for joint load supervision, joint collision supervision, and collision detection. Because the supervision is designed to be very sensitive it may trip if there are large process forces acting on the robot.

If the load is not correctly defined, use the load identification service routine to specify it. If large external process forces are present in most parts of the application, such as during deburring, then use the system parameters to raise the supervision level of the motion supervision until it no longer triggers. If, the external forces are only temporary, such as during the closing of a large spotweld gun, then the `MotionSup` instruction should be used to raise the supervision level (or turn the function off) for those parts of the application where the disturbance acts.

Basic examples

The following example illustrates the instruction `MotionSup`:

Example 1

```
! If the motion supervision is active in the system parameters,  
! then it is active by default during program execution  
...  
! If motion supervision is deactivated in the system parameters  
! then it cannot be activated using the MotionSup instruction  
...  
! Deactivate motion supervision during program execution  
MotionSup \Off;  
...  
! Activate motion supervision again during program execution  
MotionSup \On;  
...  
! Tune the supervision level to 200% (makes the function less  
! sensitive) of the level in  
! the system parameters  
MotionSup \On \TuneValue:= 200;  
...  
! Activate motion supervision again.  
! No back off at a motion collision  
MotionSup \On \NoBackoff;
```

Continues on next page

1.143 MotionSup - Deactivates/Activates motion supervision Collision Detection Continued

Arguments

MotionSup[\On] | [\Off] [\TuneValue] [\NoBackoff]

[\On]

Data type: *switch*

Activate the motion supervision function during program execution (if it has already been activated in system parameters).

[\Off]

Data type: *switch*

Deactivate the motion supervision function during program execution.

One of the arguments `\On` or `\Off` must be specified.

[\TuneValue]

Data type: *num*

Tuning the motion supervision sensitivity level in percent (1 - 300%) of system parameter level. A higher level gives more robust sensitivity. This argument can only be combined with argument `\On`.

[\NoBackoff]

Data type: *switch*

If this switch is used, the robot does not back off at a motion collision. This argument can only be combined with argument `\On`.

Program execution

The specified motion supervision applies for the next executed movement instruction until a new `MotionSup` instruction is executed.

If the motion supervision function is active both in the system parameters and in the RAPID program, and the motion supervision is triggered because of a collision, then

- the robot will stop as quickly as possible
- the robot will back up to remove any residual forces (if `\NoBackoff` switch has not been used on last `MotionSup` instruction)
- the program execution will stop with an error message

If motion supervision is active in system parameters it is then active by default during program execution (`TuneValue:=100`, and back up to remove any residual forces). These values are set automatically

- when using the restart mode **Reset RAPID**
- when loading a new program or a new module
- when starting program execution from the beginning
- when moving the program pointer to `main`
- when moving the program pointer to a routine
- when moving the program pointer in such a way that the execution order is lost.

Continues on next page

1 Instructions

1.143 MotionSup - Deactivates/Activates motion supervision

Collision Detection

Continued

Limitations

- Motion supervision is never active for external axes or when one or more joints are run in independent joint mode. When using the robot in the soft servo mode it may be necessary to turn the motion supervision off to avoid accidental tripping.
 - If motion supervision is deactivated in the system parameters, then it cannot be activated using the MotionSup instruction.
-

Syntax

```
MotionSup  
[ '\ On ] | [ '\ Off ]  
[ '\ Tunevalue':='< expression (IN) of num> ]  
[ '\ NoBackoff ] ';' 
```

Related information

For information about	See
Motion settings data	motsetdata - Motion settings data on page 1692
General description of the function	<i>Technical reference manual - RAPID Overview</i>
Tuning using system parameters	<i>Technical reference manual - System parameters</i>
LoadIdentify, load identification service routine	<i>Operating manual - IRC5 with FlexPendant</i>

1.144 MoveAbsJ - Moves the robot to an absolute joint position

Usage

`MoveAbsJ` (*Move Absolute Joint*) is used to move the robot and external axes to an absolute position defined in axes positions. For example, if the end point is a singular point

The final position of the robot during a movement with `MoveAbsJ` is neither affected by the given tool and work object nor by active program displacement. The robot uses this data to calculate the load, TCP velocity, and the corner path. The same tools can be used in adjacent movement instructions.

The robot and external axes move to the destination position along a non-linear path. All axes reach the destination position at the same time.

This instruction can only be used in the main task `T_ROB1` or, if in a *MultiMove* system, in Motion tasks.

Basic examples

The following examples illustrate the instruction `MoveAbsJ`:

See also [More examples on page 399](#).

Example 1

```
MoveAbsJ p50, v1000, z50, tool2;
```

The robot with the tool `tool2` is moved along a non-linear path to the absolute axis position, `p50`, with velocity data `v1000` and zone data `z50`.

Example 2

```
MoveAbsJ *, v1000\T:=5, fine, grip3;
```

The robot with the tool `grip3` is moved along a non-linear path to a stop point which is stored as an absolute axis position in the instruction (marked with an `*`). The entire movement takes 5 seconds.

Arguments

```
MoveAbsJ [\Conc] ToJointPos [\ID] [\NoEOffs] Speed [\V] | [\T] Zone
[\Z] [\Inpos] Tool [\WObj] [\TLoad]
```

[`\Conc`]

Concurrent

Data type: switch

Subsequent instructions are executed while the robot is moving. The argument is usually not used but can be used to avoid unwanted stops caused by overloaded CPU when using fly-by points. This is useful when the programmed points are very close together at high speeds. The argument is also useful when, for example, communicating with external equipment and synchronization between the external equipment and robot movement is not required.

Using the argument `\Conc`, the number of movement instructions in succession is limited to 5. In a program section that includes `StorePath-RestoPath`, movement instructions with the argument `\Conc` are not permitted.

Continues on next page

1 Instructions

1.144 MoveAbsJ - Moves the robot to an absolute joint position

RobotWare Base

Continued

If this argument is omitted and the `ToPoint` is not a stop point then the subsequent instruction is executed some time before the robot has reached the programmed zone.

This argument cannot be used in coordinated synchronized movement in a MultiMove system.

`ToJointPos`

Data type: `jointtarget`

The destination absolute joint position of the robot and external axes. It is defined as a named position or stored directly in the instruction (marked with an * in the instruction).

[`\ID`]

Synchronization id

Data type: `identno`

The argument [`\ID`] is mandatory in MultiMove systems, if the movement is synchronized or coordinated synchronized. This argument is not allowed in any other case. The specified id number must be the same in all the cooperating program tasks. By using the id number the movements are not mixed up at the runtime.

[`\NoEOffs`]

No External Offsets

Data type: `switch`

If the argument `\NoEOffs` is set then the movement with `TriggAbsJ` is not affected by active offsets for external axes.

`Speed`

Data type: `speeddata`

The speed data that applies to movements. Speed data defines the velocity of the TCP, the tool reorientation, and external axes.

[`\V`]

Velocity

Data type: `num`

This argument is used to specify the velocity of the TCP in mm/s directly in the instruction. It is then substituted for the corresponding velocity specified in the speed data.

[`\T`]

Time

Data type: `num`

This argument is used to specify the total time in seconds during which the robot moves. It is substituted for the corresponding speed data. The speed data is computed under the assumption that the speed is constant during the movement. If the robot cannot keep this speed during the whole movement, for example, when

Continues on next page

1.144 MoveAbsJ - Moves the robot to an absolute joint position

RobotWare Base

Continued

the movement starts from a finepoint or ends in a finepoint, the actual movement time will be larger than the programmed time.

Zone

Data type: zonedata

Zone data for the movement. Zone data describes the size of the generated corner path.

[\Z]

Zone

Data type: num

This argument is used to specify the position accuracy of the robot TCP directly in the instruction. The length of the corner path is given in mm, which is substituted for the corresponding zone specified in the zone data.

[\Inpos]

In position

Data type: stoppoint data

This argument is used to specify the convergence criteria for the position of the robot's TCP in the stop point. The stop point data substitutes the zone specified in the `Zone` parameter.

Tool

Data type: tooldata

The tool in use when the robot moves. The tool center point is the point that is moved to the specified destination point.

[\Wobj]

Work Object

Data type: wobjdata

The work object (object coordinate system) to which the robot position in the instruction is related.

This argument can be omitted and if it is then the position is related to the world coordinate system. If, on the other hand, a stationary TCP or coordinated external axes are used this argument must be specified in order for a circle relative to the work object to be executed.

[\TLoad]

Total load

Data type: loaddata

The `\TLoad` argument describes the total load used in the movement. The total load is the tool load together with the payload that the tool is carrying. If the `\TLoad` argument is used, then the `loaddata` in the current `tooldata` is not considered.

If the `\TLoad` argument is set to `load0`, then the `\TLoad` argument is not considered and the `loaddata` in the current `tooldata` is used instead.

Continues on next page

1 Instructions

1.144 MoveAbsJ - Moves the robot to an absolute joint position

RobotWare Base

Continued

To be able to use the `\TLoad` argument it is necessary to set the value of the system parameter `ModalPayloadMode` to 0. If `ModalPayloadMode` is set to 0, it is no longer possible to use the instruction `GripLoad`.

The total load can be identified with the service routine `LoadIdentify`. If the system parameter `ModalPayloadMode` is set to 0, the operator has the possibility to copy the `loaddata` from the tool to an existing or new `loaddata` persistent variable when running the service routine.

It is possible to test run the program without any payload by using a digital input signal connected to the system input `SimMode` (Simulated Mode). If the digital input signal is set to 1, the `loaddata` in the optional argument `\TLoad` is not considered, and the `loaddata` in the current `tooldata` is used instead.



Note

The default functionality to handle payload is to use the instruction `GripLoad`. Therefore the default value of the system parameter `ModalPayloadMode` is 1.

Program execution

A movement with `MoveAbsJ` is not affected by active program displacement and if executed with switch `\NoEOffs` there will be no offset for external axes. Without switch `\NoEOffs` the external axes in the destination target are affected by active offset for external axes.

The tool is moved to the destination absolute joint position with interpolation of the axis angles. This means that each axis is moved with constant axis velocity and that all axes reach the destination joint position at the same time, which results in a non-linear path.

Generally speaking, the TCP is moved at approximate programmed velocity. The tool is reoriented and the external axes are moved at the same time as the TCP moves. If the programmed velocity for reorientation or for the external axes cannot be attained, the velocity of the TCP will be reduced.

A corner path is usually generated when movement is transferred to the next section of the path. If a stop point is specified in the zone data program execution only continues when the robot and external axes have reached the appropriate joint position.

Error handling

The following recoverable errors can be generated. The errors can be handled in an ERROR handler. The system variable `ERRNO` will be set to:

Name	Cause of error
<code>ERR_CONC_MAX</code>	The number of movement instructions in succession using argument <code>\Conc</code> has been exceeded.

Continues on next page

More examples

More examples of how to use the instruction `MoveAbsJ` are illustrated below.

Example 1

```
MoveAbsJ *, v2000\V:=2200, z40 \Z:=45, grip3;
```

The tool, `grip3`, is moved along a non-linear path to an absolute joint position stored in the instruction. The movement is carried out with data set to `v2000` and `z40`. The velocity and zone size of the TCP are 2200 mm/s and 45 mm respectively.

Example 2

```
MoveAbsJ p5, v2000, fine \Inpos := inpos50, grip3;
```

The tool, `grip3`, is moved along a non-linear path to an absolute joint position `p5`. The robot considers it to be in the point when 50% of the position condition and 50% of the speed condition for a stop point `fine` are satisfied. It waits at most for 2 seconds for the conditions to be satisfied. See predefined data `inpos50` of data type `stoppointdata`.

Example 3

```
MoveAbsJ \Conc, *, v2000, z40, grip3;
```

The tool, `grip3`, is moved along a non-linear path to an absolute joint position stored in the instruction. Subsequent logical instructions are executed while the robot moves.

Example 4

```
MoveAbsJ \Conc, * \NoEOffs, v2000, z40, grip3;
```

Same movement as above but the movement is not affected by active offsets for external axes.

Example 5

```
GripLoad obj_mass;  
MoveAbsJ start, v2000, z40, grip3 \WObj:= obj;
```

The robot moves the work object `obj` in relation to the fixed tool `grip3` along a non-linear path to an absolute axis position `start`.

Continues on next page

1 Instructions

1.144 MoveAbsJ - Moves the robot to an absolute joint position

RobotWare Base

Continued

Limitations

To run backwards with the instruction `MoveAbsJ` involved and avoiding problems with singular points or ambiguous areas, it is essential that the subsequent instructions fulfil certain requirements as follows (see figure below).

The figure shows limitation for backward execution with `MoveAbsJ`.

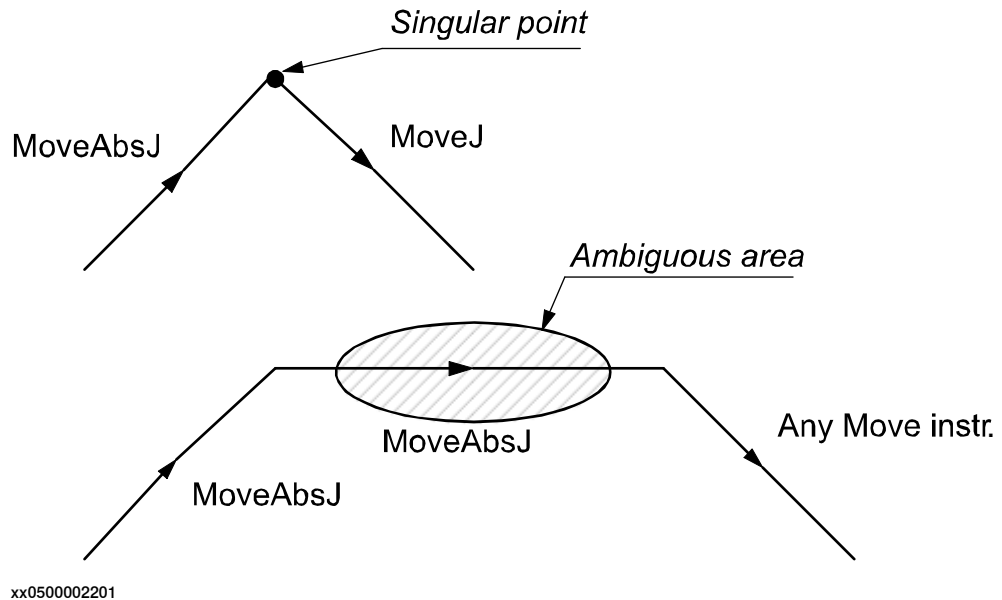

xx0500002201

`MoveAbsJ` cannot be executed in an UNDO handler or RAPID routine connected to any of the following special system events: PowerOn, Stop, QStop, Restart, Reset or Step.

Syntax

```
MoveAbsJ
['\ ' Conc ',']
[ToJointPos ':=' ] <expression (IN) of jointtarget>
['\ ' ID ':=' <expression (IN) of identno>]
['\ ' NoEoffs'],'
[Speed ':=' ] <expression (IN) of speeddata>
['\ ' V ':=' <expression (IN) of num>]
|['\ ' T ':=' <expression (IN) of num>'],'
[Zone ':=' ] <expression (IN) of zonedata>
['\ ' Z ':=' ] <expression (IN) of num >
['\ ' Inpos ':=' <expression (IN) of stoppointdata>'],'
[Tool ':=' ] <persistent (PERS) of tooldata>
['\ ' WObj ':=' <persistent (PERS) of wobjdata>]
['\ ' TLoad ':=' <persistent (PERS) of loaddata>'];'
```

Related information

For information about	See
Other positioning instructions	<i>Technical reference manual - RAPID Overview</i>
Definition of jointtarget	jointtarget - Joint position data on page 1679
Definition of load	loaddata - Load data on page 1682

Continues on next page

1.144 MoveAbsJ - Moves the robot to an absolute joint position

RobotWare Base

Continued

For information about	See
Definition of velocity	speeddata - Speed data on page 1751
Definition of stop point data	stoppointdata - Stop point data on page 1755
Definition of tools	tooldata - Tool data on page 1776
Definition of work objects	wobjdata - Work object data on page 1803
Definition of zone data	zonedata - Zone data on page 1811
Motion in general	<i>Technical reference manual - RAPID Overview</i>
Concurrent program execution	<i>Technical reference manual - RAPID Overview</i>
Example of how to use TLoad, Total Load.	MoveL - Moves the robot linearly on page 458
Defining the payload for a robot	GripLoad - Defines the payload for a robot on page 243
LoadIdentify, load identification service routine	<i>Operating manual - IRC5 with FlexPendant</i>
System input signal <i>SimMode</i> for running the robot in simulated mode without payload.	<i>Technical reference manual - System parameters</i>
System parameter <i>ModalPayloadMode</i> for activating and deactivating payload.	<i>Technical reference manual - System parameters</i>

1 Instructions

1.145 MoveC - Moves the robot circularly *RobotWare Base*

1.145 MoveC - Moves the robot circularly

Usage

`MoveC` is used to move the tool center point (TCP) circularly to a given destination. During the movement the orientation normally remains unchanged relative to the circle.

This instruction can only be used in the main task `T_ROB1` or, if in a *MultiMove* system, in Motion tasks.

Basic examples

The following examples illustrate the instruction `MoveC`:

See also [More examples on page 406](#).

Example 1

```
MoveC p1, p2, v500, z30, tool2;
```

The TCP of the tool, `tool2`, is moved circularly to the position `p2` with speed data `v500` and zone data `z30`. The circle is defined from the start position, the circle point `p1`, and the destination point `p2`.

Example 2

```
MoveC *, *, v500 \T:=5, fine, grip3;
```

The TCP of the tool, `grip3`, is moved circularly to a fine point stored in the instruction (marked by the second `*`). The circle point is also stored in the instruction (marked by the first `*`). The complete movement takes 5 seconds.

Example 3

```
MoveL p1, v500, fine, tool1;  
MoveC p2, p3, v500, z20, tool1;  
MoveC p4, p1, v500, fine, tool1;
```

The figure shows how a complete circle is performed by two `MoveC` instructions.

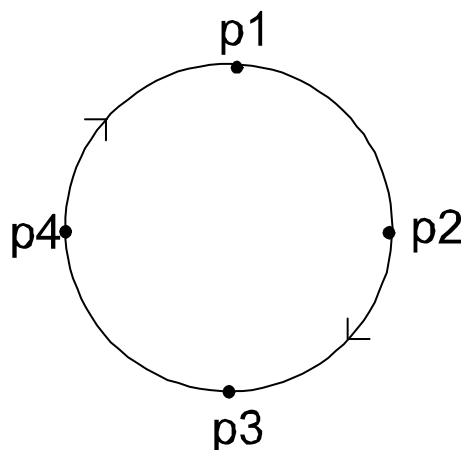

xx0500002212

Arguments

```
MoveC [\Conc] CirPoint ToPoint [\ID] Speed [\V] | [\T] Zone [\Z]  
[\Inpos] Tool [\WObj] [\Corr] [\TLoad]
```

Continues on next page

[\Conc]

Concurrent

Data type: switch

Subsequent instructions are executed while the robot is moving. The argument is usually not used but can be used to avoid unwanted stops caused by overloaded CPU when using fly-by points. This is useful when the programmed points are very close together at high speeds. The argument is also useful when, for example, communicating with external equipment and synchronization between the external equipment and robot movement is not required.

Using the argument \Conc, the number of movement instructions in succession is limited to 5. In a program section that includes StorePath-RestPath, movement instructions with the argument \Conc are not permitted.

If this argument is omitted and the ToPoint is not a stop point then the subsequent instruction is executed some time before the robot has reached the programmed zone.

This argument cannot be used in coordinated synchronized movement in a MultiMove system.

CirPoint

Data type: robtarget

The circle point of the robot. The circle point is a position on the circle between the start point and the destination point. To obtain the best accuracy it should be placed about halfway between the start and destination points. If it is placed too close to the start or destination point, the robot may give a warning. The circle point is defined as a named position or stored directly in the instruction (marked with an * in the instruction). The position of the external axes are not used.

ToPoint

Data type: robtarget

The destination point of the robot and external axes. It is defined as a named position or stored directly in the instruction (marked with an * in the instruction).

[\ID]

Synchronization id

Data type: identno

The argument [\ID] is mandatory in MultiMove systems, if the movement is synchronized or coordinated synchronized. This argument is not allowed in any other case. The specified id number must be the same in all the cooperating program tasks. By using the id number the movements are not mixed up at the runtime.

Speed

Data type: speeddata

The speed data that applies to movements. Speed data defines the velocity of the TCP, the tool reorientation, and external axes.

Continues on next page

1 Instructions

1.145 MoveC - Moves the robot circularly

RobotWare Base

Continued

[\V]

Velocity

Data type: num

This argument is used to specify the velocity of the TCP in mm/s directly in the instruction. It is then substituted for the corresponding velocity specified in the speed data.

[\T]

Time

Data type: num

This argument is used to specify the total time in seconds during which the robot moves. It is substituted for the corresponding speed data. The speed data is computed under the assumption that the speed is constant during the movement. If the robot cannot keep this speed during the whole movement, for example, when the movement starts from a finepoint or ends in a finepoint, the actual movement time will be larger than the programmed time.

Zone

Data type: zonedata

Zone data for the movement. Zone data describes the size of the generated corner path.

[\Z]

Zone

Data type: num

This argument is used to specify the position accuracy of the robot TCP directly in the instruction. The length of the corner path is given in mm, which is substituted for the corresponding zone specified in the zone data.

[\Inpos]

In position

Data type: stoppoint data

This argument is used to specify the convergence criteria for the position of the robot's TCP in the stop point. The stop point data substitutes the zone specified in the Zone parameter.

Tool

Data type: tooldata

The tool in use when the robot moves. The tool center point is the point that is moved to the specified destination point.

[\WObj]

Work Object

Data type: wobjdata

The work object (object coordinate system) to which the robot position in the instruction is related.

Continues on next page

This argument can be omitted and if it is then the position is related to the world coordinate system. If, on the other hand, a stationary TCP or coordinated external axes are used this argument must be specified in order for a circle relative to the work object to be executed.

[\Corr]

Correction

Data type: `switch`

Correction data written to a corrections entry by the instruction `CorrWrite` will be added to the path and destination position if this argument is present.

The RobotWare option *Path Offset* is required when using this argument.

[\TLoad]

Total load

Data type: `loaddata`

The `\TLoad` argument describes the total load used in the movement. The total load is the tool load together with the payload that the tool is carrying. If the `\TLoad` argument is used, then the `loaddata` in the current `tooldata` is not considered. If the `\TLoad` argument is set to `load0`, then the `\TLoad` argument is not considered and the `loaddata` in the current `tooldata` is used instead.

To be able to use the `\TLoad` argument it is necessary to set the value of the system parameter `ModalPayLoadMode` to 0. If `ModalPayLoadMode` is set to 0, it is no longer possible to use the instruction `GripLoad`.

The total load can be identified with the service routine `LoadIdentify`. If the system parameter `ModalPayLoadMode` is set to 0, the operator has the possibility to copy the `loaddata` from the tool to an existing or new `loaddata` persistent variable when running the service routine.

It is possible to test run the program without any payload by using a digital input signal connected to the system input `SimMode` (Simulated Mode). If the digital input signal is set to 1, the `loaddata` in the optional argument `\TLoad` is not considered, and the `loaddata` in the current `tooldata` is used instead.



Note

The default functionality to handle payload is to use the instruction `GripLoad`. Therefore the default value of the system parameter `ModalPayLoadMode` is 1.

Program execution

The robot and external units are moved to the destination point as follows:

- The TCP of the tool is moved circularly at a constant programmed velocity.
- The tool is reoriented at a constant velocity from the orientation at the start position to the orientation at the destination point.
- The reorientation is performed relative to the circular path. Thus, if the orientation relative to the path is the same at the start and the destination

Continues on next page

1 Instructions

1.145 MoveC - Moves the robot circularly

RobotWare Base

Continued

points, the relative orientation remains unchanged during the movement (see figure below).

The figure shows tool orientation during circular movement.

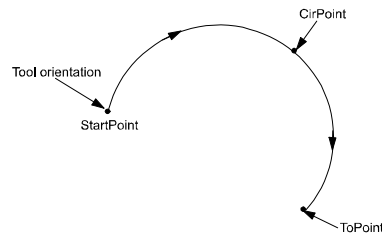

xx0500002214

The orientation in the circle point is not reached. It is only used to distinguish between two possible directions of reorientation. The accuracy of the reorientation along the path depends only on the orientation at the start and destination points. Different modes for tool orientation during circle path are described in instruction `CirPathMode`.

Uncoordinated external axes are executed at constant velocity in order for them to arrive at the destination point at the same time as the robot axes. The position in the circle position is not used.

If it is not possible to attain the programmed velocity for the reorientation or for the external axes, the velocity of the TCP will be reduced.

A corner path is usually generated when movement is transferred to the next section of a path. If a stop point is specified in the zone data, program execution only continues when the robot and external axes have reached the appropriate position.

If the starting point, circle point, and the destination point are collinear, then the `MoveC` instruction will result in a linear movement.

Error handling

The following recoverable errors are generated and can be handled in an error handler. The system variable `ERRNO` will be set to:

Name	Cause of error
<code>ERR_CONC_MAX</code>	The number of movement instructions in succession using argument <code>\Conc</code> has been exceeded.

More examples

More examples of how to use the instruction `MoveC` are illustrated below.

Example 1

```
MoveC *, *, v500 \V:=550, z40 \Z:=45, grip3;
```

The TCP of the tool, `grip3`, is moved circularly to a position stored in the instruction. The movement is carried out with data set to `v500` and `z40`; the velocity and zone size of the TCP are 550 mm/s and 45 mm respectively.

Continues on next page

Example 2

```
MoveC p5, p6, v2000, fine \Inpos := inpos50, grip3;
```

The TCP of the tool, `grip3`, is moved circularly to a stop point `p6`. The robot considers it to be in the point when 50% of the position condition and 50% of the speed condition for a stop point `fine` are satisfied. It waits at most for 2 seconds for the conditions to be satisfied. See predefined data `inpos50` of data type `stoppointdata`.

Example 3

```
MoveC \Conc, *, *, v500, z40, grip3;
```

The TCP of the tool, `grip3`, is moved circularly to a position stored in the instruction. The circle point is also stored in the instruction. Subsequent logical instructions are executed while the robot moves.

Example 4

```
MoveC cir1, p15, v500, z40, grip3 \WObj:=fixture;
```

The TCP of the tool, `grip3`, is moved circularly to a position, `p15` via the circle point `cir1`. These positions are specified in the object coordinate system for `fixture`.

Limitations

There are some limitations in how the `CirPoint` and the `ToPoint` can be placed.

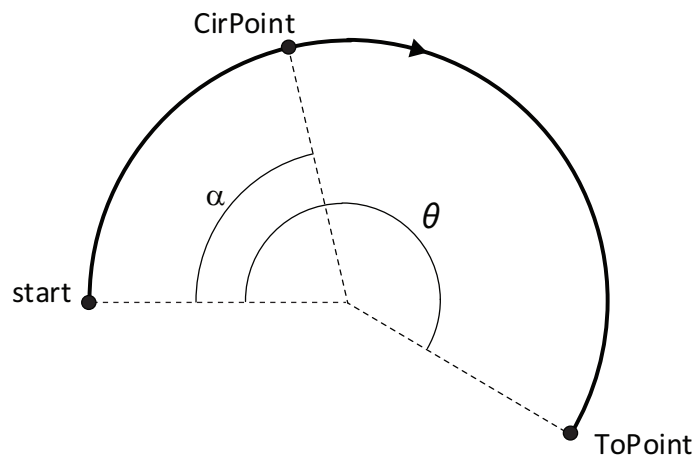

xx1700001575

- Minimum distance between `start` and `ToPoint` is 0.1 mm
- Minimum distance between `start` and `CirPoint` is 0.1 mm
- Minimum distance between `CirPoint` and `ToPoint` is 0.1 mm
- If the system parameter *Restrict placing of circle points* is set to Yes, then the following additional limitations are active:
 - The angle of the circular path (θ in the picture above) may not be larger than 240° .
 - The circle point must be in the middle part of the circular path (α must be 25-75% of θ , according to the picture above).

Continues on next page

1 Instructions

1.145 MoveC - Moves the robot circularly

RobotWare Base

Continued

The accuracy can be poor near the limits, e.g. if the start point and the `ToPoint` on the circle are close to each other then the fault caused by the leaning of the circle can be much greater than the accuracy with which the points have been programmed.

Ensure that the robot can reach the circle point during program execution and divide the circle movement order if necessary.

A change of execution mode from forward to backward or vice versa while the robot is stopped on a circular path is not permitted and will result in an error message.



WARNING

The instruction `MoveC` (or any other instruction including circular movement) should never be started from the beginning with TCP between the circle point and the end point. Otherwise the robot will not take the programmed path (positioning around the circular path in another direction compared with that which is programmed).

To minimize the risk, set the system parameter *Restrict placing of circlepoints to Yes* (type *Motion Planner*, topic *Motion*).

`MoveC` cannot be executed in an UNDO handler or RAPID routine connected to any of the following special system events: PowerOn, Stop, QStop, Restart, Reset or Step.

Syntax

```
MoveC
  ['\ ' Conc ',']
  [CirPoint ':=' ] <expression (IN) of robtarg>','
  [ToPoint ':=' ] <expression (IN) of robtarg>','
  ['\ ' ID ':=' <expression (IN) of identno>'],'
  [Speed ':=' ] <expression (IN) of speeddata>
  ['\ ' V ':=' <expression (IN) of num>]
  |['\ ' T ':=' <expression (IN) of num>'],'
  [Zone ':=' ] <expression (IN) of zonedata>
  ['\ ' Z ':=' <expression (IN) of num>]
  ['\ ' Inpos ':=' <expression (IN) of stoppointdata>'],'
  [Tool ':=' ] <persistent (PERS) of tooldata>
  ['\ ' WObj ':=' <persistent (PERS) of wobjdata>]
  ['\ ' Corr]
  ['\ ' TLoad ':=' <persistent (PERS) of loaddata>'];'
```

Related information

For information about	See
Other positioning instructions	Technical reference manual - RAPID Overview
Definition of load	loaddata - Load data on page 1682
Definition of velocity	speeddata - Speed data on page 1751
Definition of stop point data	stoppointdata - Stop point data on page 1755

Continues on next page

For information about	See
Definition of tools	tooldata - Tool data on page 1776
Definition of work objects	wobjdata - Work object data on page 1803
Definition of zone data	zonedata - Zone data on page 1811
Writes to a corrections entry	CorrWrite - Writes to a correction generator on page 180
Tool reorientation during circle path	CirPathMode - Tool reorientation during circle path on page 132
Motion in general	<i>Technical reference manual - RAPID Overview</i>
Coordinate systems	<i>Technical reference manual - RAPID Overview</i>
Concurrent program execution	<i>Technical reference manual - RAPID Overview</i>
System parameters	<i>Technical reference manual - System parameters</i>
Example of how to use TLoad, Total Load.	MoveL - Moves the robot linearly on page 458
Defining the payload for a robot	GripLoad - Defines the payload for a robot on page 243
LoadIdentify, load identification service routine	<i>Operating manual - IRC5 with FlexPendant</i>
System input signal SimMode for running the robot in simulated mode without payload.	<i>Technical reference manual - System parameters</i>
System parameter ModalPayloadMode for activating and deactivating payload.	<i>Technical reference manual - System parameters</i>
Path Offset	<i>Application manual - Controller software IRC5</i>

1 Instructions

1.146 MoveCAO - Moves the robot circularly and sets analog output in the corner
RobotWare Base

1.146 MoveCAO - Moves the robot circularly and sets analog output in the corner

Usage

MoveCAO (*Move Circular Analog Output*) is used to move the tool center point (TCP) circularly to a given destination. The specified analog output is set in the middle of the corner path at the destination point. During the movement the orientation normally remains unchanged relative to the circle.

This instruction can only be used in the main task `T_ROB1` or, if in a *MultiMove* system, in Motion tasks.

Basic examples

The following example illustrates the instruction MoveCAO:

Example 1

```
MoveCAO p1, p2, v500, z30, tool2, ao1, 1.1;
```

The TCP of the tool, `tool2`, is moved circularly to the position `p2` with speed data `v500` and zone data `z30`. The circle is defined from the start position, the circle point `p1`, and the destination point `p2`. Output `ao1` is set in the middle of the corner path at `p2`.

Arguments

```
MoveCAO CirPoint ToPoint [\ID] Speed [\T] Zone Tool [\WObj] Signal  
Value [\TLoad]
```

CirPoint

Data type: `robtarget`

The circle point of the robot. The circle point is a position on the circle between the start point and the destination point. To obtain the best accuracy it should be placed about halfway between the start and destination points. If it is placed too close to the start or destination point the robot may give a warning. The circle point is defined as a named position or stored directly in the instruction (marked with an * in the instruction). The position of the external axes are not used.

ToPoint

Data type: `robtarget`

The destination point of the robot and external axes. It is defined as a named position or stored directly in the instruction (marked with an * in the instruction).

[\ID]

Synchronization id

Data type: `identno`

The argument [\ID] is mandatory in MultiMove systems, if the movement is synchronized or coordinated synchronized. This argument is not allowed in any other case. The specified id number must be the same in all the cooperating program tasks. By using the id number the movements are not mixed up at the runtime.

Continues on next page

1.146 MoveCAO - Moves the robot circularly and sets analog output in the corner *RobotWare Base* *Continued*

Speed

Data type: speeddata

The speed data that applies to movements. Speed data defines the velocity of the TCP, the tool reorientation, and external axes.

[\T]

Time

Data type: num

This argument is used to specify the total time in seconds during which the robot moves. It is substituted for the corresponding speed data. The speed data is computed under the assumption that the speed is constant during the movement. If the robot cannot keep this speed during the whole movement, for example, when the movement starts from a finepoint or ends in a finepoint, the actual movement time will be larger than the programmed time.

Zone

Data type: zonedata

Zone data for the movement. Zone data describes the size of the generated corner path.

Tool

Data type: tooldata

The tool in use when the robot moves. The tool center point is the point that is moved to the specified destination point.

[\WObj]

Work Object

Data type: wobjdata

The work object (object coordinate system) to which the robot position in the instruction is related.

This argument can be omitted and if so then the position is related to the world coordinate system. If, on the other hand, a stationary TCP or coordinated external axes are used then this argument must be specified in order for a circle relative to the work object to be executed.

Signal

Data type: signalao

The name of the analog output signal to be changed.

Value

Data type: num

The desired value of signal.

[\TLoad]

Total load

Data type: loaddata

Continues on next page

1 Instructions

1.146 MoveCAO - Moves the robot circularly and sets analog output in the corner

RobotWare Base

Continued

The `\TLoad` argument describes the total load used in the movement. The total load is the tool load together with the payload that the tool is carrying. If the `\TLoad` argument is used, then the `loaddata` in the current `tooldata` is not considered. If the `\TLoad` argument is set to `load0`, then the `\TLoad` argument is not considered and the `loaddata` in the current `tooldata` is used instead.

To be able to use the `\TLoad` argument it is necessary to set the value of the system parameter `ModalPayloadMode` to 0. If `ModalPayloadMode` is set to 0, it is no longer possible to use the instruction `GripLoad`.

The total load can be identified with the service routine `LoadIdentify`. If the system parameter `ModalPayloadMode` is set to 0, the operator has the possibility to copy the `loaddata` from the tool to an existing or new `loaddata` persistent variable when running the service routine.

It is possible to test run the program without any payload by using a digital input signal connected to the system input `SimMode` (Simulated Mode). If the digital input signal is set to 1, the `loaddata` in the optional argument `\TLoad` is not considered, and the `loaddata` in the current `tooldata` is used instead.



Note

The default functionality to handle payload is to use the instruction `GripLoad`. Therefore the default value of the system parameter `ModalPayloadMode` is 1.

Program execution

See the instruction `MoveC` for more information about circular movement, [MoveC - Moves the robot circularly on page 402](#).

The analog output signal is set in the middle of the corner path for flying points, as shown in figure below.

The figure shows set of analog output signal in the corner path with `MoveCAO`.

```
MoveCAO p2, p2, v500, z30, tool2, ao1, 1.1;
```

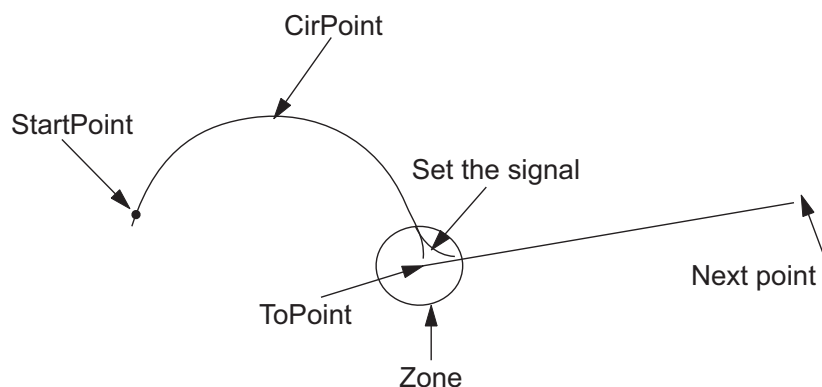

xx1400001116

For stop points we recommend the use of "normal" programming sequence with `MoveC` and `SetAO`. But when using stop point in instruction `MoveCAO` the analog output signal is set when the robot reaches the stop point.

Continues on next page

1.146 MoveCAO - Moves the robot circularly and sets analog output in the corner

RobotWare Base
Continued

The specified I/O signal is set in execution mode continuously and stepwise forward, but not in stepwise backward.

Error handling

The following recoverable errors are generated and can be handled in an error handler. The system variable `ERRNO` will be set to:

Name	Cause of error
ERR_AO_LIM	The programmed <code>Value</code> argument for the specified analog output signal <code>Signal</code> is outside limits.
ERR_NO_ALIASIO_DEF	The signal variable is a variable declared in RAPID. It has not been connected to an I/O signal defined in the I/O configuration with instruction <code>AliasIO</code> .
ERR_NORUNUNIT	There is no contact with the I/O device.
ERR_SIG_NOT_VALID	The I/O signal cannot be accessed. The reasons can be that the I/O device is not running or an error in the configuration (only valid for ICI field bus).

Limitations

General limitations according to instruction `MoveC`, see [MoveC - Moves the robot circularly on page 402](#).

`MoveCAO` cannot be executed in an UNDO handler or RAPID routine connected to any of the following special system events: `PowerOn`, `Stop`, `QStop`, `Restart`, `Reset` or `Step`.

Syntax

```
MoveCAO
  [CirPoint ':='] <expression (IN) of robtarget>', '
  [ToPoint ':='] <expression (IN) of robtarget>', '
  ['\ ' ID ':=' <expression (IN) of identno>'],' '
  [Speed ':='] <expression (IN) of speeddata>
  |['\ ' T ':=' <expression (IN) of num>'],' '
  [Zone ':='] <expression (IN) of zonedata>', '
  [Tool ':='] <persistent (PERS) of tooldata>
  ['\ ' WObj ':=' <persistent (PERS) of wobjdata>'],' '
  [Signal ':='] <variable (VAR) of signalao>', '
  [Value ':='] <expression (IN) of num>
  ['\ ' TLoad ':=' <persistent (PERS) of loaddata>'];'
```

Related information

For information about	See
Other positioning instructions	Technical reference manual - RAPID Overview
Move the robot circularly	MoveC - Moves the robot circularly on page 402
Definition of load	loaddata - Load data on page 1682
Definition of velocity	speeddata - Speed data on page 1751
Definition of tools	tooldata - Tool data on page 1776
Definition of work objects	wobjdata - Work object data on page 1803

Continues on next page

1 Instructions

1.146 MoveCAO - Moves the robot circularly and sets analog output in the corner

RobotWare Base

Continued

For information about	See
Definition of zone data	zonedata - Zone data on page 1811
Motion in general	<i>Technical reference manual - RAPID Overview</i>
Coordinate systems	<i>Technical reference manual - RAPID Overview</i>
Movements with I/O settings	<i>Technical reference manual - RAPID Overview</i>
Example of how to use TLoad, Total Load.	MoveL - Moves the robot linearly on page 458
Defining the payload for a robot	GripLoad - Defines the payload for a robot on page 243
LoadIdentify, load identification service routine	<i>Operating manual - IRC5 with FlexPendant</i>
System input signal SimMode for running the robot in simulated mode without payload.	<i>Technical reference manual - System parameters</i>
System parameter ModalPayLoad-Mode for activating and deactivating payload.	<i>Technical reference manual - System parameters</i>

1.147 MoveCDO - Moves the robot circularly and sets digital output in the corner RobotWare Base

1.147 MoveCDO - Moves the robot circularly and sets digital output in the corner

Usage

`MoveCDO` (*Move Circular Digital Output*) is used to move the tool center point (TCP) circularly to a given destination. The specified digital output is set/reset in the middle of the corner path at the destination point. During the movement the orientation normally remains unchanged relative to the circle.

This instruction can only be used in the main task `T_ROB1` or, if in a *MultiMove* system, in Motion tasks.

Basic examples

The following example illustrates the instruction `MoveCDO`:

Example 1

```
MoveCDO p1, p2, v500, z30, tool2, do1,1;
```

The TCP of the tool, `tool2`, is moved circularly to the position `p2` with speed data `v500` and zone data `z30`. The circle is defined from the start position, the circle point `p1`, and the destination point `p2`. Output `do1` is set in the middle of the corner path at `p2`.

Arguments

```
MoveCDO CirPoint ToPoint [\ID] Speed [\T] Zone Tool [\WObj] Signal
Value [\TLoad]
```

CirPoint

Data type: `robtarget`

The circle point of the robot. The circle point is a position on the circle between the start point and the destination point. To obtain the best accuracy it should be placed about halfway between the start and destination points. If it is placed too close to the start or destination point the robot may give a warning. The circle point is defined as a named position or stored directly in the instruction (marked with an * in the instruction). The position of the external axes are not used.

ToPoint

Data type: `robtarget`

The destination point of the robot and external axes. It is defined as a named position or stored directly in the instruction (marked with an * in the instruction).

[\ID]

Synchronization id

Data type: `identno`

The argument `[\ID]` is mandatory in *MultiMove* systems, if the movement is synchronized or coordinated synchronized. This argument is not allowed in any other case. The specified id number must be the same in all the cooperating program tasks. By using the id number the movements are not mixed up at the runtime.

Continues on next page

1 Instructions

1.147 MoveCDO - Moves the robot circularly and sets digital output in the corner

RobotWare Base

Continued

Speed

Data type: speeddata

The speed data that applies to movements. Speed data defines the velocity of the TCP, the tool reorientation, and external axes.

[\T]

Time

Data type: num

This argument is used to specify the total time in seconds during which the robot moves. It is substituted for the corresponding speed data. The speed data is computed under the assumption that the speed is constant during the movement. If the robot cannot keep this speed during the whole movement, for example, when the movement starts from a finepoint or ends in a finepoint, the actual movement time will be larger than the programmed time.

Zone

Data type: zonedata

Zone data for the movement. Zone data describes the size of the generated corner path.

Tool

Data type: tooldata

The tool in use when the robot moves. The tool center point is the point that is moved to the specified destination point.

[\WObj]

Work Object

Data type: wobjdata

The work object (object coordinate system) to which the robot position in the instruction is related.

This argument can be omitted and if so then the position is related to the world coordinate system. If, on the other hand, a stationary TCP or coordinated external axes are used then this argument must be specified in order for a circle relative to the work object to be executed.

Signal

Data type: signaldo

The name of the digital output signal to be changed.

Value

Data type: dionum

The desired value of signal (0 or 1).

[\TLoad]

Total load

Data type: loaddata

Continues on next page

1.147 MoveCDO - Moves the robot circularly and sets digital output in the corner RobotWare Base Continued

The `\TLoad` argument describes the total load used in the movement. The total load is the tool load together with the payload that the tool is carrying. If the `\TLoad` argument is used, then the `loaddata` in the current `tooldata` is not considered. If the `\TLoad` argument is set to `load0`, then the `\TLoad` argument is not considered and the `loaddata` in the current `tooldata` is used instead.

To be able to use the `\TLoad` argument it is necessary to set the value of the system parameter `ModalPayloadMode` to 0. If `ModalPayloadMode` is set to 0, it is no longer possible to use the instruction `GripLoad`.

The total load can be identified with the service routine `LoadIdentify`. If the system parameter `ModalPayloadMode` is set to 0, the operator has the possibility to copy the `loaddata` from the tool to an existing or new `loaddata` persistent variable when running the service routine.

It is possible to test run the program without any payload by using a digital input signal connected to the system input `SimMode` (Simulated Mode). If the digital input signal is set to 1, the `loaddata` in the optional argument `\TLoad` is not considered, and the `loaddata` in the current `tooldata` is used instead.



Note

The default functionality to handle payload is to use the instruction `GripLoad`. Therefore the default value of the system parameter `ModalPayloadMode` is 1.

Program execution

See the instruction `MoveC` for more information about circular movement.

The digital output signal is set/reset in the middle of the corner path for flying points, as shown in figure below.

The figure shows set/reset of digital output signal in the corner path with `MoveCDO`.

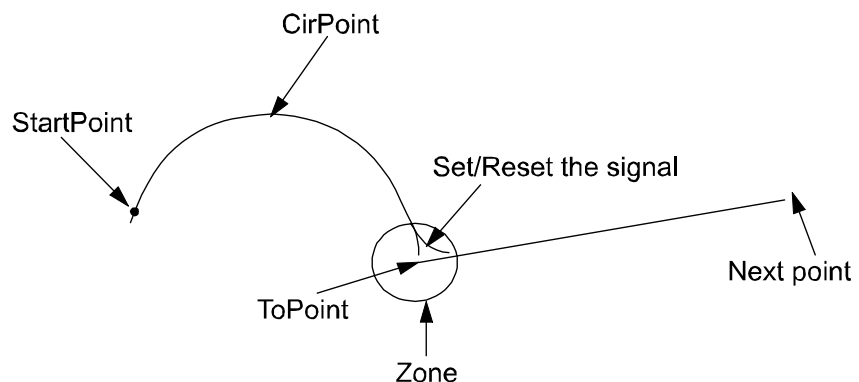

xx0500002215

For stop points we recommend the use of “normal” programming sequence with `MoveC + SetDO`. But when using stop point in instruction `MoveCDO` the digital output signal is set/reset when the robot reaches the stop point.

The specified I/O signal is set/reset in execution mode continuously and stepwise forward, but not in stepwise backward.

Continues on next page

1 Instructions

1.147 MoveCDO - Moves the robot circularly and sets digital output in the corner

RobotWare Base

Continued

Error handling

The following recoverable errors are generated and can be handled in an error handler. The system variable `ERRNO` will be set to:

Name	Cause of error
<code>ERR_NO_ALIASIO_DEF</code>	The signal variable is a variable declared in RAPID. It has not been connected to an I/O signal defined in the I/O configuration with instruction <code>AliasIO</code> .
<code>ERR_NORUNUNIT</code>	There is no contact with the I/O device.
<code>ERR_SIG_NOT_VALID</code>	The I/O signal cannot be accessed. The reasons can be that the I/O device is not running or an error in the configuration (only valid for ICI field bus).

Limitations

General limitations according to instruction `MoveC`.

`MoveCDO` cannot be executed in an UNDO handler or RAPID routine connected to any of the following special system events: `PowerOn`, `Stop`, `QStop`, `Restart`, `Reset` or `Step`.

Syntax

```
MoveCDO
  [CirPoint ':='] <expression (IN) of robtarg>','
  [ToPoint ':='] <expression (IN) of robtarg>','
  ['\ ID ':=' <expression (IN) of identno>'],'
  [Speed ':='] <expression (IN) of speeddata>
  [['\ T ':=' <expression (IN) of num>'],'
  [Zone ':='] <expression (IN) of zonedata>','
  [Tool ':='] <persistent (PERS) of tooldata>
  ['\ WObj ':=' <persistent (PERS) of wobjdata>'],'
  [Signal ':='] <variable (VAR) of signaldo>','
  [Value ':='] <expression (IN) of dionum>
  ['\ TLoad ':=' <persistent (PERS) of loaddata>'];'
```

Related information

For information about	See
Other positioning instructions	<i>Technical reference manual - RAPID Overview</i>
Move the robot circularly	MoveC - Moves the robot circularly on page 402
Definition of load	loaddata - Load data on page 1682
Definition of velocity	speeddata - Speed data on page 1751
Definition of tools	tooldata - Tool data on page 1776
Definition of work objects	wobjdata - Work object data on page 1803
Definition of zone data	zonedata - Zone data on page 1811
Motion in general	<i>Technical reference manual - RAPID Overview</i>
Coordinate systems	<i>Technical reference manual - RAPID Overview</i>
Movements with I/O settings	<i>Technical reference manual - RAPID Overview</i>

Continues on next page

1.147 MoveCDO - Moves the robot circularly and sets digital output in the corner
RobotWare Base
Continued

For information about	See
Example of how to use <code>TLoad</code> , Total Load.	MoveL - Moves the robot linearly on page 458
Defining the payload for a robot	GripLoad - Defines the payload for a robot on page 243
LoadIdentify, load identification service routine	<i>Operating manual - IRC5 with FlexPendant</i>
System input signal <i>SimMode</i> for running the robot in simulated mode without payload.	<i>Technical reference manual - System parameters</i>
System parameter <i>ModalPayload-Mode</i> for activating and deactivating payload.	<i>Technical reference manual - System parameters</i>

1 Instructions

1.148 MoveCGO - Moves the robot circularly and set a group output signal in the corner
RobotWare Base

1.148 MoveCGO - Moves the robot circularly and set a group output signal in the corner

Usage

MoveCGO (*Move Circular Group Output*) is used to move the tool center point (TCP) circularly to a given destination. The specified group output signal is set in the middle of the corner path at the destination point. During the movement the orientation normally remains unchanged relative to the circle.

This instruction can only be used in the main task T_ROB1 or, if in a *MultiMove* system, in Motion tasks.

Basic examples

The following example illustrates the instruction MoveCGO:

Example 1

```
MoveCGO p1, p2, v500, z30, tool2, go1 \Value:=5;
```

The TCP of the tool, tool2, is moved circularly to the position p2 with speed data v500 and zone data z30. The circle is defined from the start position, the circle point p1, and the destination point p2. Group output signal go1 is set in the middle of the corner path at p2.

Arguments

```
MoveCGO CirPoint ToPoint [\ID] Speed [\T] Zone Tool [\WObj] Signal  
[\Value] | [\DValue] [\TLoad]
```

CirPoint

Data type: robtarget

The circle point of the robot. The circle point is a position on the circle between the start point and the destination point. To obtain the best accuracy it should be placed about halfway between the start and destination points. If it is placed too close to the start or destination point the robot may give a warning. The circle point is defined as a named position or stored directly in the instruction (marked with an * in the instruction). The position of the external axes are not used.

ToPoint

Data type: robtarget

The destination point of the robot and external axes. It is defined as a named position or stored directly in the instruction (marked with an * in the instruction).

[\ID]

Synchronization id

Data type: identno

The argument [\ID] is mandatory in MultiMove systems, if the movement is synchronized or coordinated synchronized. This argument is not allowed in any other case. The specified id number must be the same in all the cooperating program tasks. By using the id number the movements are not mixed up at the runtime.

Continues on next page

1.148 MoveCGO - Moves the robot circularly and set a group output signal in the corner

RobotWare Base

Continued

Speed

Data type: speeddata

The speed data that applies to movements. Speed data defines the velocity of the TCP, the tool reorientation, and external axes.

[\T]

Time

Data type: num

This argument is used to specify the total time in seconds during which the robot moves. It is substituted for the corresponding speed data. The speed data is computed under the assumption that the speed is constant during the movement. If the robot cannot keep this speed during the whole movement, for example, when the movement starts from a finepoint or ends in a finepoint, the actual movement time will be larger than the programmed time.

Zone

Data type: zonedata

Zone data for the movement. Zone data describes the size of the generated corner path.

Tool

Data type: tooldata

The tool in use when the robot moves. The tool center point is the point that is moved to the specified destination point.

[\WObj]

Work Object

Data type: wobjdata

The work object (object coordinate system) to which the robot position in the instruction is related.

This argument can be omitted and if so then the position is related to the world coordinate system. If, on the other hand, a stationary TCP or coordinated external axes are used then this argument must be specified in order for a circle relative to the work object to be executed.

Signal

Data type: signalgo

The name of the group output signal to be changed.

[\Value]

Data type: num

The desired value of signal.

[\DValue]

Data type: dnum

The desired value of signal.

Continues on next page

1 Instructions

1.148 MoveCGO - Moves the robot circularly and set a group output signal in the corner

RobotWare Base

Continued

If none of the arguments `\Value` or `\DValue` is entered, an error message will be displayed.

[`\TLoad`]

Total load

Data type: `loaddata`

The `\TLoad` argument describes the total load used in the movement. The total load is the tool load together with the payload that the tool is carrying. If the `\TLoad` argument is used, then the `loaddata` in the current `tooldata` is not considered.

If the `\TLoad` argument is set to `load0`, then the `\TLoad` argument is not considered and the `loaddata` in the current `tooldata` is used instead.

To be able to use the `\TLoad` argument it is necessary to set the value of the system parameter `ModalPayLoadMode` to 0. If `ModalPayLoadMode` is set to 0, it is no longer possible to use the instruction `GripLoad`.

The total load can be identified with the service routine `LoadIdentify`. If the system parameter `ModalPayLoadMode` is set to 0, the operator has the possibility to copy the `loaddata` from the tool to an existing or new `loaddata` persistent variable when running the service routine.

It is possible to test run the program without any payload by using a digital input signal connected to the system input `SimMode` (Simulated Mode). If the digital input signal is set to 1, the `loaddata` in the optional argument `\TLoad` is not considered, and the `loaddata` in the current `tooldata` is used instead.



Note

The default functionality to handle payload is to use the instruction `GripLoad`. Therefore the default value of the system parameter `ModalPayLoadMode` is 1.

Program execution

See the instruction `MoveC` for more information about circular movement, [MoveC - Moves the robot circularly on page 402](#).

The group output signal is set in the middle of the corner path for flying points, as shown in figure below.

The figure shows set of group output signal in the corner path with `MoveCGO`.

```
MoveCGO p2, p2, v500, z30, tool2, go1 \Value:=5;
```

Continues on next page

1.148 MoveCGO - Moves the robot circularly and set a group output signal in the corner

RobotWare Base

Continued

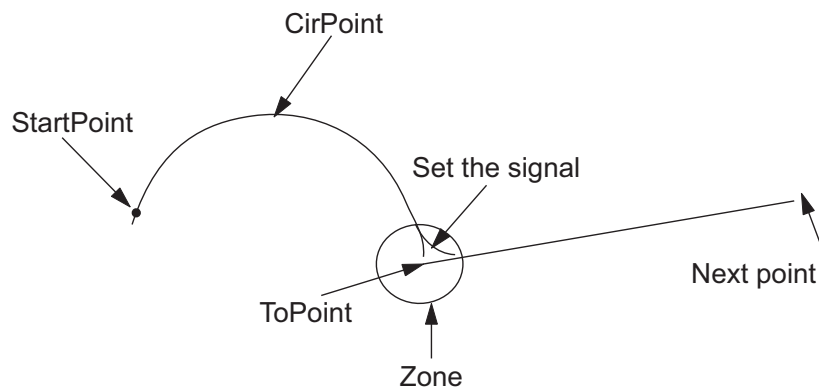

xx1400001116

For stop points we recommend the use of "normal" programming sequence with `MoveC` and `SetGO`. But when using stop point in instruction `MoveCGO` the group output signal is set when the robot reaches the stop point.

The specified I/O signal is set in execution mode continuously and stepwise forward, but not in stepwise backward.

Error handling

The following recoverable errors are generated and can be handled in an error handler. The system variable `ERRNO` will be set to:

Name	Cause of error
<code>ERR_GO_LIM</code>	Value or <code>DValue</code> argument for the specified group output signal is outside limits.
<code>ERR_NO_ALIASIO_DEF</code>	The signal variable is a variable declared in RAPID. It has not been connected to an I/O signal defined in the I/O configuration with instruction <code>AliasIO</code> .
<code>ERR_NORUNUNIT</code>	There is no contact with the I/O device.
<code>ERR_SIG_NOT_VALID</code>	The I/O signal cannot be accessed. The reasons can be that the I/O device is not running or an error in the configuration (only valid for ICI field bus).

Limitations

General limitations according to instruction `MoveC`, see [MoveC - Moves the robot circularly on page 402](#).

`MoveCGO` cannot be executed in an UNDO handler or RAPID routine connected to any of the following special system events: `PowerOn`, `Stop`, `QStop`, `Restart`, `Reset` or `Step`.

Syntax

```
MoveCGO
  [CirPoint ::=] <expression (IN) of robtarg>','
  [ToPoint ::=] <expression (IN) of robtarg>','
  ['\ ID ::=] <expression (IN) of identno>','
  [Speed ::=] <expression (IN) of speeddata>
  [['\ T ::=] <expression (IN) of num>','
  [Zone ::=] <expression (IN) of zonedata>','
```

Continues on next page

1 Instructions

1.148 MoveCGO - Moves the robot circularly and set a group output signal in the corner

RobotWare Base

Continued

```
[Tool ':='] <persistent (PERS) of tooldata>
['\ ' WObj ':=' <persistent (PERS) of wobjdata>'],'
[Signal ':='] <variable (VAR) of signalgo>'],'
['\ ' Value ':='] <expression (IN) of num>]
[['\ ' Dvalue ':='] <expression (IN) of dnum>
['\ ' TLoad ':=' <persistent (PERS) of loaddata>'];'
```

Related information

For information about	See
Other positioning instructions	<i>Technical reference manual - RAPID Overview</i>
Move the robot circularly	MoveC - Moves the robot circularly on page 402
Definition of load	loaddata - Load data on page 1682
Definition of velocity	speeddata - Speed data on page 1751
Definition of tools	tooldata - Tool data on page 1776
Definition of work objects	wobjdata - Work object data on page 1803
Definition of zone data	zonedata - Zone data on page 1811
Motion in general	<i>Technical reference manual - RAPID Overview</i>
Coordinate systems	<i>Technical reference manual - RAPID Overview</i>
Movements with I/O settings	<i>Technical reference manual - RAPID Overview</i>
Example of how to use TLoad, Total Load.	MoveL - Moves the robot linearly on page 458
Defining the payload for a robot	GripLoad - Defines the payload for a robot on page 243
LoadIdentify, load identification service routine	<i>Operating manual - IRC5 with FlexPendant</i>
System input signal <i>SimMode</i> for running the robot in simulated mode without payload.	<i>Technical reference manual - System parameters</i>
System parameter <i>ModalPayload-Mode</i> for activating and deactivating payload.	<i>Technical reference manual - System parameters</i>

1.149 MoveCSync - Moves the robot circularly and executes a RAPID procedure

Usage

`MoveCSync` (*Move Circular Synchronously*) is used to move the tool center point (TCP) circularly to a given destination. The specified RAPID procedure is ordered to execute at the middle of the corner path in the destination point. During the movement the orientation normally remains unchanged relative to the circle.

This instruction can only be used in the main task `T_ROB1` or, if in a *MultiMove* system, in Motion tasks.

Basic examples

The following examples illustrate the instruction `MoveCSync`:

Example 1

```
MoveCSync p1, p2, v500, z30, tool2, "proc1";
```

The TCP of the tool, `tool2`, is moved circularly to the position `p2` with speed data `v500` and zone data `z30`. The circle is defined from the start position, the circle point `p1`, and the destination point `p2`. Procedure `proc1` is executed in the middle of the corner path at `p2`.

Example 2

```
MoveCSync p1, p2, v500, z30, tool2, "MyModule:proc1";
```

The same as in example 1 above, but here the locally declared procedure `proc1` in module `MyModule` will be called in the middle of the corner path.

Arguments

```
MoveCSync CirPoint ToPoint [\ID] Speed [\T] Zone Tool [\WObj]
          ProcName [\TLoad]
```

CirPoint

Data type: `robtarget`

The circle point of the robot. The circle point is a position on the circle between the start point and the destination point. To obtain the best accuracy it should be placed about halfway between the start and destination points. If it is placed too close to the start or destination point, the robot may give a warning. The circle point is defined as a named position or stored directly in the instruction (marked with an * in the instruction). The position of the external axes are not used.

ToPoint

Data type: `robtarget`

The destination point of the robot and external axes. It is defined as a named position or stored directly in the instruction (marked with an * in the instruction).

[\ID]

Synchronization id

Data type: `identno`

The argument [\ID] is mandatory in *MultiMove* systems, if the movement is synchronized or coordinated synchronized. This argument is not allowed in any

Continues on next page

1 Instructions

1.149 MoveCSync - Moves the robot circularly and executes a RAPID procedure

RobotWare Base

Continued

other case. The specified id number must be the same in all the cooperating program tasks. By using the id number the movements are not mixed up at the runtime.

Speed

Data type: speeddata

The speed data that applies to movements. Speed data defines the velocity of the TCP, the tool reorientation, and external axes.

[\T]

Time

Data type: num

This argument is used to specify the total time in seconds during which the robot moves. It is substituted for the corresponding speed data. The speed data is computed under the assumption that the speed is constant during the movement. If the robot cannot keep this speed during the whole movement, for example, when the movement starts from a finepoint or ends in a finepoint, the actual movement time will be larger than the programmed time.

Zone

Data type: zonedata

Zone data for the movement. Zone data describes the size of the generated corner path.

Tool

Data type: tooldata

The tool in use when the robot moves. The tool center point is the point that is moved to the specified destination point.

[\WObj]

Work Object

Data type: wobjdata

The work object (object coordinate system) to which the robot position in the instruction is related.

This argument can be omitted and if it is then the position is related to the world coordinate system. If, on the other hand, a stationary TCP or coordinated external axes are used this argument must be specified in order for a circle relative to the work object to be executed.

ProcName

Procedure Name

Data type: string

Name of the RAPID procedure to be executed at the middle of the corner path in the destination point.

The procedure will execute on trap level (see description of program execution).

[\TLoad]

Total load

Continues on next page

1.149 MoveCSync - Moves the robot circularly and executes a RAPID procedure

RobotWare Base
Continued

Data type: loaddata

The `\TLoad` argument describes the total load used in the movement. The total load is the tool load together with the payload that the tool is carrying. If the `\TLoad` argument is used, then the `loaddata` in the current `tooldata` is not considered.

If the `\TLoad` argument is set to `load0`, then the `\TLoad` argument is not considered and the `loaddata` in the current `tooldata` is used instead.

To be able to use the `\TLoad` argument it is necessary to set the value of the system parameter `ModalPayloadMode` to 0. If `ModalPayloadMode` is set to 0, it is no longer possible to use the instruction `GripLoad`.

The total load can be identified with the service routine `LoadIdentify`. If the system parameter `ModalPayloadMode` is set to 0, the operator has the possibility to copy the `loaddata` from the tool to an existing or new `loaddata` persistent variable when running the service routine.

It is possible to test run the program without any payload by using a digital input signal connected to the system input `SimMode` (Simulated Mode). If the digital input signal is set to 1, the `loaddata` in the optional argument `\TLoad` is not considered, and the `loaddata` in the current `tooldata` is used instead.



Note

The default functionality to handle payload is to use the instruction `GripLoad`. Therefore the default value of the system parameter `ModalPayloadMode` is 1.

Program execution

See the instruction `MoveC` for more information about circular movements.

The specified RAPID procedure is ordered to execute when the TCP reaches the middle of the corner path in the destination point of the `MoveCSync` instruction, as shown in the figure below.

The figure shows that the order to execute the user defined RAPID procedure is done at the middle of the corner path.

```
MoveCSync p2, p3, v1000, z30, tool2, "my_proc";
```

When TCP is here,
my_proc is executed

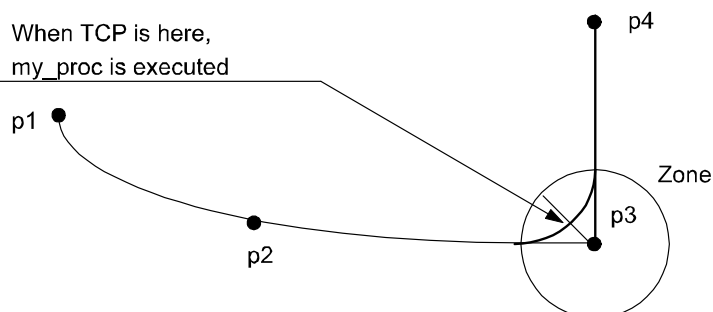

xx0500002216

For stop points we recommend the use of normal programming sequence with `MoveC +` and other RAPID instructions in sequence.

Continues on next page

1 Instructions

1.149 MoveCSync - Moves the robot circularly and executes a RAPID procedure

RobotWare Base

Continued

The table describes execution of the specified RAPID procedure in different execution modes:

Execution mode	Execution of RAPID procedure
Continuously or Cycle	According to this description
Forward step	In the stop point
Backward step	Not at all

MoveCSync is an encapsulation of the instructions TriggInt and TriggC. The procedure call is executed on trap level.

If the middle of the corner path in the destination point is reached during the deceleration after a program stop, the procedure will not be called (program execution is stopped). The procedure call will be executed at next program start.

Limitations

General limitations according to the instruction MoveC.

When the robot reaches the middle of the corner path there is normally a delay of 2-30 ms until the specified RAPID routine is executed depending on what type of movement is being performed at the time.

Switching execution mode after program stop from continuously or cycle to stepwise forward or backward results in an error. This error tells the user that the mode switch can result in missed execution of the RAPID procedure in the queue for execution on the path.

Instruction MoveCSync cannot be used on trap level. The specified RAPID procedure cannot be tested with stepwise execution.

MoveCSync cannot be executed in an UNDO handler or RAPID routine connected to any of the following special system events: PowerOn, Stop, QStop, Restart, Reset or Step.

Syntax

```
MoveCSync
  [CirPoint ':=' ] <expression (IN) of robtarg>','
  [ToPoint ':=' ] <expression (IN) of robtarg>','
  ['\ ' ID ':=' ] <expression (IN) of identno>'],'
  [Speed ':=' ] <expression (IN) of speeddata>
  [['\ ' T ':=' ] <expression (IN) of num>'],'
  [Zone ':=' ] <expression (IN) of zonedata>','
  [Tool ':=' ] <persistent (PERS) of tooldata>
  ['\ ' WObj ':=' ] <persistent (PERS) of wobjdata>'],'
  [ProcName ':=' ] <expression (IN) of string>
  ['\ ' TLoad ':=' ] <persistent (PERS) of loaddata>'];'
```

Related information

For information about	See
Other positioning instructions	<i>Technical reference manual - RAPID Overview</i>
Moves the robot circularly	MoveC - Moves the robot circularly on page 402

Continues on next page

1.149 MoveCSync - Moves the robot circularly and executes a RAPID procedure

*RobotWare Base
Continued*

For information about	See
Definition of load	loaddata - Load data on page 1682
Definition of velocity	speeddata - Speed data on page 1751
Definition of tools	tooldata - Tool data on page 1776
Definition of work objects	wobjdata - Work object data on page 1803
Definition of zone data	zonedata - Zone data on page 1811
Motion in general	<i>Technical reference manual - RAPID Overview</i>
Coordinate systems	<i>Technical reference manual - RAPID Overview</i>
Defines a position related interrupt	TriggInt - Defines a position related interrupt on page 916
Circular robot movement with events	TriggC - Circular robot movement with events on page 891
Example of how to use TLoad, Total Load.	MoveL - Moves the robot linearly on page 458
Defining the payload for a robot	GripLoad - Defines the payload for a robot on page 243
LoadIdentify, load identification service routine	<i>Operating manual - IRC5 with FlexPendant</i>
System input signal <i>SimMode</i> for running the robot in simulated mode without payload.	<i>Technical reference manual - System parameters</i>
System parameter <i>ModalPayloadMode</i> for activating and deactivating payload.	

1 Instructions

1.150 MoveExtJ - Move one or several mechanical units without TCP

RobotWare Base

1.150 MoveExtJ - Move one or several mechanical units without TCP

Usage

`MoveExtJ` (*Move External Joints*) is used to move linear or rotating external axes. The external axes can belong to one or several mechanical units without TCP. This instruction can only be used with an actual program task defined as a Motion Task and if the task controls one or several mechanical units without TCP.

Basic examples

The following examples illustrate the instruction `MoveExtJ`:

See also [More examples on page 432](#).

Example 1

```
MoveExtJ jpos10, vrot10, z50;
```

Move rotational external axes to joint position `jpos10` with speed 10 degrees/s with zone data `z50`.

Example 2

```
MoveExtJ \Conc, jpos20, vrot10 \T:=5, fine \InPos:=inpos20;
```

Move external axes to joint position `jpos20` in 5. The program execution goes forward at once but the external axes stops in the position `jpos20` until the convergence criteria in `inpos20` are fulfilled.

Arguments

```
MoveExtJ [\Conc] ToJointPos [\ID] [\UseEOffs] Speed [\T] Zone  
[\Inpos]
```

[`\Conc`]

Concurrent

Data type: switch

Subsequent instructions are executed while the robot is moving. The argument is usually not used but can be used to avoid unwanted stops caused by overloaded CPU when using fly-by points. This is useful when the programmed points are very close together at high speeds. The argument is also useful when, for example, communicating with external equipment and synchronization between the external equipment and robot movement is not required.

Using the argument `\Conc`, the number of movement instructions in succession is limited to 5. In a program section that includes `StorePath-RestoPath`, movement instructions with the argument `\Conc` are not permitted.

If this argument is omitted and the `ToPoint` is not a stop point then the subsequent instruction is executed some time before the robot has reached the programmed zone.

This argument cannot be used in coordinated synchronized movement in a MultiMove system.

`ToJointPos`

To Joint Position

Continues on next page

Data type: jointtarget

The destination absolute joint position of the external axes. It is defined as a named position or stored directly in the instruction (marked with an * in the instruction).

[\ID]

Synchronization id

Data type: identno

The argument [\ID] is mandatory in MultiMove systems, if the movement is synchronized or coordinated synchronized. This argument is not allowed in any other case. The specified id number must be the same in all the cooperating program tasks. By using the id number the movements are not mixed up at the runtime.

[\UseEOffs]

Use External Offset

Data type: switch

The offset for external axes, setup by instruction EOffsSet, is activated for MoveExtJ instruction when the argument UseEOffs is used. See instruction EOffsSet for more information about external offset.

Speed

Data type: speeddata

The speed data that applies to movements. Speed data defines the velocity of the TCP, the tool reorientation, and external axes.

[\T]

Time

Data type: num

This argument is used to specify the total time in seconds during which the robot moves. It is substituted for the corresponding speed data. The speed data is computed under the assumption that the speed is constant during the movement. If the robot cannot keep this speed during the whole movement, for example, when the movement starts from a finepoint or ends in a finepoint, the actual movement time will be larger than the programmed time.

Zone

Data type: zonedata

Zone data for the movement. Zone data describes the size of the generated corner path.

[\Inpos]

In position

Data type: stoppoint data

This argument is used to specify the convergence criteria for the position of the robot's TCP in the stop point. The stop point data substitutes the zone specified in the Zone parameter.

Continues on next page

1 Instructions

1.150 MoveExtJ - Move one or several mechanical units without TCP

RobotWare Base

Continued

Program execution

The linear or rotating external axes are moved to the programmed point with the programmed velocity.

Error handling

The following recoverable errors are generated and can be handled in an error handler. The system variable `ERRNO` will be set to:

Name	Cause of error
<code>ERR_CONC_MAX</code>	The number of movement instructions in succession using argument <code>\Conc</code> has been exceeded.

More examples

```
CONST jointtarget j1 :=
  [[9E9,9E9,9E9,9E9,9E9,9E9],[0,9E9,9E9,9E9,9E9,9E9]];
CONST jointtarget j2 :=
  [[9E9,9E9,9E9,9E9,9E9,9E9],[30,9E9,9E9,9E9,9E9,9E9]];
CONST jointtarget j3 :=
  [[9E9,9E9,9E9,9E9,9E9,9E9],[60,9E9,9E9,9E9,9E9,9E9]];
CONST jointtarget j4 :=
  [[9E9,9E9,9E9,9E9,9E9,9E9],[90,9E9,9E9,9E9,9E9,9E9]];
CONST speeddata rot_ax_speed := [0, 0, 0, 45];

MoveExtJ j1, rot_ax_speed, fine;
MoveExtJ j2, rot_ax_speed, z20;
MoveExtJ j3, rot_ax_speed, z20;
MoveExtJ j4, rot_ax_speed, fine;
```

In this example the rotating single axis is moved to joint position 0, 30, 60, and 90 degrees with the speed of 45 degrees/s.

Limitations

`MoveExtJ` cannot be executed in an UNDO handler or RAPID routine connected to any of the following special system events: PowerOn, Stop, QStop, Restart, Reset or Step.

Syntax

```
MoveExtJ
[ '\ Conc ',' ]
[ ToJointPos ':=' ] < expression (IN) of jointtarget >
[ '\ ID ':=' < expression (IN) of identno >'],'
[ '\ UseEOffs ',' ]
[ Speed ':=' ] < expression (IN) of speeddata >
[ '\ T ':=' < expression (IN) of num > ] ','
[ Zone ':=' ] < expression (IN) of zonedata >
[ '\ Inpos ':=' < expression (IN) of stoppointdata > ] '';
```

Related information

For information about	See
Other positioning instructions	<i>Technical reference manual - RAPID Overview</i>

Continues on next page

1.150 MoveExtJ - Move one or several mechanical units without TCP

RobotWare Base

Continued

For information about	See
Definition of jointtarget	jointtarget - Joint position data on page 1679
Definition of velocity	speeddata - Speed data on page 1751
Definition of zone data	zonedata - Zone data on page 1811
Motion in general	<i>Technical reference manual - RAPID Overview</i>
Concurrent program execution	<i>Technical reference manual - RAPID Overview</i>

1 Instructions

1.151 MoveJ - Moves the robot by joint movement

RobotWare Base

1.151 MoveJ - Moves the robot by joint movement

Usage

`MoveJ` is used to move the robot quickly from one point to another when that movement does not have to be in a straight line.

The robot and external axes move to the destination position along a non-linear path. All axes reach the destination position at the same time.

This instruction can only be used in the main task `T_ROB1` or, if in a *MultiMove* system, in Motion tasks.

Basic examples

The following examples illustrate the instruction `MoveJ`:

See also [More examples on page 437](#).

Example 1

```
MoveJ p1, vmax, z30, tool2;
```

The tool center point (TCP) of the tool, `tool2`, is moved along a non-linear path to the position, `p1`, with speed data `vmax` and zone data `z30`.

Example 2

```
MoveJ *, vmax \T:=5, fine, grip3;
```

The TCP of the tool, `grip3`, is moved along a non-linear path to a stop point stored in the instruction (marked with an `*`). The entire movement takes 5 seconds.

Arguments

```
MoveJ [\Conc] ToPoint [\ID] Speed [\V] | [\T] Zone [\Z] [\Inpos]  
Tool [\WObj] [\TLoad]
```

[`\Conc`]

Concurrent

Data type: `switch`

Subsequent instructions are executed while the robot is moving. The argument is usually not used but can be used to avoid unwanted stops caused by overloaded CPU when using fly-by points. This is useful when the programmed points are very close together at high speeds. The argument is also useful when, for example, communicating with external equipment and synchronization between the external equipment and robot movement is not required.

Using the argument `\Conc`, the number of movement instructions in succession is limited to 5. In a program section that includes `StorePath-RestoPath` movement instructions with the argument `\Conc` are not permitted.

If this argument is omitted and the `ToPoint` is not a stop point, the subsequent instruction is executed some time before the robot has reached the programmed zone.

This argument cannot be used in coordinated synchronized movement in a *MultiMove* system.

Continues on next page

ToPoint

Data type: `robtarget`

The destination point of the robot and external axes. It is defined as a named position or stored directly in the instruction (marked with an * in the instruction).

[\ID]

Synchronization id

Data type: `identno`

This argument must be used in a MultiMove system, if coordinated synchronized movement, and is not allowed in any other cases.

The specified id number must be the same in all cooperating program tasks. The id number gives a guarantee that the movements are not mixed up at runtime.

Speed

Data type: `speeddata`

The speed data that applies to movements. Speed data defines the velocity of the tool center point, the tool reorientation, and external axes.

[\V]

Velocity

Data type: `num`

This argument is used to specify the velocity of the TCP in mm/s directly in the instruction. It is then substituted for the corresponding velocity specified in the speed data.

[\T]

Time

Data type: `num`

This argument is used to specify the total time in seconds during which the robot moves. It is substituted for the corresponding speed data. The speed data is computed under the assumption that the speed is constant during the movement. If the robot cannot keep this speed during the whole movement, for example, when the movement starts from a finepoint or ends in a finepoint, the actual movement time will be larger than the programmed time.

Zone

Data type: `zonedata`

Zone data for the movement. Zone data describes the size of the generated corner path.

[\Z]

Zone

Data type: `num`

This argument is used to specify the position accuracy of the robot TCP directly in the instruction. The length of the corner path is given in mm, which is substituted for the corresponding zone specified in the zone data.

Continues on next page

1 Instructions

1.151 MoveJ - Moves the robot by joint movement

RobotWare Base

Continued

[\Inpos]

In position

Data type: stoppointdata

This argument is used to specify the convergence criteria for the position of the robot's TCP in the stop point. The stop point data substitutes the zone specified in the `Zone` parameter.

Tool

Data type: tooldata

The tool in use when the robot moves. The tool center point is the point moved to the specified destination point.

[\Wobj]

Work Object

Data type: wobjdata

The work object (coordinate system) to which the robot position in the instruction is related.

This argument can be omitted and if so then the position is related to the world coordinate system. If, on the other hand, a stationary TCP or coordinated external axes are used then this argument must be specified.

[\TLoad]

Total load

Data type: loaddata

The `\TLoad` argument describes the total load used in the movement. The total load is the tool load together with the payload that the tool is carrying. If the `\TLoad` argument is used, then the `loaddata` in the current `tooldata` is not considered.

If the `\TLoad` argument is set to `load0`, then the `\TLoad` argument is not considered and the `loaddata` in the current `tooldata` is used instead.

To be able to use the `\TLoad` argument it is necessary to set the value of the system parameter `ModalPayloadMode` to 0. If `ModalPayloadMode` is set to 0, it is no longer possible to use the instruction `GripLoad`.

The total load can be identified with the service routine `LoadIdentify`. If the system parameter `ModalPayloadMode` is set to 0, the operator has the possibility to copy the `loaddata` from the tool to an existing or new `loaddata` persistent variable when running the service routine.

It is possible to test run the program without any payload by using a digital input signal connected to the system input `SimMode` (Simulated Mode). If the digital input signal is set to 1, the `loaddata` in the optional argument `\TLoad` is not considered, and the `loaddata` in the current `tooldata` is used instead.



Note

The default functionality to handle payload is to use the instruction `GripLoad`. Therefore the default value of the system parameter `ModalPayloadMode` is 1.

Continues on next page

Program execution

The tool center point is moved to the destination point with interpolation of the axis angles. This means that each axis is moved with constant axis velocity and that all axes reach the destination point at the same time, which results in a non-linear path.

Generally speaking, the TCP is moved at the approximate programmed velocity (regardless of whether or not the external axes are coordinated). The tool is reoriented and the external axes are moved at the same time that the TCP moves. If the programmed velocity for reorientation or for the external axes cannot be attained then the velocity of the TCP will be reduced.

A corner path is usually generated when movement is transferred to the next section of the path. If a stop point is specified in the zone data the program execution only continues when the robot and external axes have reached the appropriate position.

Error handling

The following recoverable errors are generated and can be handled in an error handler. The system variable `ERRNO` will be set to:

Name	Cause of error
<code>ERR_CONC_MAX</code>	The number of movement instructions in succession using argument <code>\Conc</code> has been exceeded.

More examples

More examples of how to use the instruction `MoveJ` are illustrated below.

Example 1

```
MoveJ *, v2000\V:=2200, z40 \Z:=45, grip3;
```

The TCP of the tool, `grip3`, is moved along a non-linear path to a position stored in the instruction. The movement is carried out with data set to `v2000` and `z40`; the velocity and zone size of the TCP are 2200 mm/s and 45 mm respectively.

Example 2

```
MoveJ p5, v2000, fine \Inpos := inpos50, grip3;
```

The TCP of the tool, `grip3`, is moved in a non-linear path to a stop point `p5`. The robot considers it to be in the point when 50% of the position condition and 50% of the speed condition for a stop point `fine` are satisfied. It waits at most for 2 seconds for the conditions to be satisfied. See predefined data `inpos50` of data type `stoppointdata`.

Example 3

```
MoveJ \Conc, *, v2000, z40, grip3;
```

The TCP of the tool, `grip3`, is moved along a non-linear path to a position stored in the instruction. Subsequent logical instructions are executed while the robot moves.

Example 4

```
MoveJ start, v2000, z40, grip3 \Wobj:=fixture;
```

Continues on next page

1 Instructions

1.151 MoveJ - Moves the robot by joint movement

RobotWare Base

Continued

The TCP of the tool, `grip3`, is moved along a non-linear path to a position, `start`. This position is specified in the object coordinate system for `fixture`.

Limitations

MoveJ cannot be executed in an UNDO handler or RAPID routine connected to any of the following special system events: PowerOn, Stop, QStop, Restart, Reset or Step.

Syntax

```
MoveJ
[ '\ ' Conc ', ' ]
[ToPoint ' := ' ] < expression (IN) of robtargget >
[ '\ ' ID ' := ' < expression (IN) of identno > ], '
[Speed ' := ' ] < expression (IN) of speeddata >
[ '\ ' V ' := ' < expression (IN) of num > ]
[ '\ ' T ' := ' <expression (IN) of num> ], '
[Zone ' := ' ] <expression (IN) of zonedata>
[ '\ ' Z ' := ' <expression (IN) of num> ]
[ '\ ' Inpos ' := ' <expression (IN) of stoppointdata> ], '
[Tool ' := ' ] <persistent (PERS) of tooldata>
[ '\ ' WObj ' := ' <persistent (PERS) of wobjdata> ]
[ '\ ' TLoad ' := ' <persistent (PERS) of loaddata> ] ;'
```

Related information

For information about	See
Other positioning instructions	<i>Technical reference manual - RAPID Overview</i>
Definition of load	loaddata - Load data on page 1682
Definition of velocity	speeddata - Speed data on page 1751
Definition of stop point data	stoppointdata - Stop point data on page 1755
Definition of tools	tooldata - Tool data on page 1776
Definition of work objects	wobjdata - Work object data on page 1803
Definition of zone data	zonedata - Zone data on page 1811
Motion in general	<i>Technical reference manual - RAPID Overview</i>
Coordinate systems	<i>Technical reference manual - RAPID Overview</i>
Concurrent program execution	<i>Technical reference manual - RAPID Overview</i>
Example of how to use TLoad, Total Load.	MoveL - Moves the robot linearly on page 458
Defining the payload for a robot	GripLoad - Defines the payload for a robot on page 243
LoadIdentify, load identification service routine	<i>Operating manual - IRC5 with FlexPendant</i>
System input signal <i>SimMode</i> for running the robot in simulated mode without payload.	<i>Technical reference manual - System parameters</i>
System parameter <i>ModalPayLoad-Mode</i> for activating and deactivating payload.	<i>Technical reference manual - System parameters</i>

1.152 MoveJAO - Moves the robot by joint movement and sets analog output in the corner
RobotWare Base

1.152 MoveJAO - Moves the robot by joint movement and sets analog output in the corner

Usage

MoveJAO (*Move Joint Analog Output*) is used to move the robot quickly from one point to another when that movement does not have to be in a straight line. The specified analog output signal is set at the middle of the corner path.

The robot and external axes move to the destination position along a non-linear path. All axes reach the destination position at the same time.

This instruction can only be used in the main task T_ROB1 or, if in a *MultiMove* system, in Motion tasks.

Basic examples

The following example illustrates the instruction MoveJAO:

Example 1

```
MoveJAO p1, vmax, z30, tool2, a01, 1.1;
```

The tool center point (TCP) of the tool, tool2, is moved along a non-linear path to the position, p1, with speed data vmax and zone data z30. Output a01 is set in the middle of the corner path at p1.

Arguments

```
MoveJAO ToPoint [\ID] Speed [\T] Zone Tool [\WObj] Signal Value
[\TLoad]
```

ToPoint

Data type: robtarget

The destination point of the robot and external axes. It is defined as a named position or stored directly in the instruction (marked with an * in the instruction).

[\ID]

Synchronization id

Data type: identno

The argument [\ID] is mandatory in the MultiMove systems, if the movement is synchronized or coordinated synchronized. This argument is not allowed in any other case. The specified id number must be the same in all the cooperating program tasks. By using the id number the movements are not mixed up at the runtime.

Speed

Data type: speeddata

The speed data that applies to movements. Speed data defines the velocity of the tool center point, the tool reorientation, and external axes.

[\T]

Time

Data type: num

Continues on next page

1 Instructions

1.152 MoveJAO - Moves the robot by joint movement and sets analog output in the corner

RobotWare Base

Continued

This argument is used to specify the total time in seconds during which the robot moves. It is substituted for the corresponding speed data. The speed data is computed under the assumption that the speed is constant during the movement. If the robot cannot keep this speed during the whole movement, for example, when the movement starts from a finepoint or ends in a finepoint, the actual movement time will be larger than the programmed time.

Zone

Data type: zonedata

Zone data for the movement. Zone data describes the size of the generated corner path.

Tool

Data type: tooldata

The tool in use when the robot moves. The tool center point is the point moved to the specified destination point.

[\WObj]

Work Object

Data type: wobjdata

The work object (coordinate system) to which the robot position in the instruction is related.

This argument can be omitted and if so then the position is related to the world coordinate system. If, on the other hand, a stationary TCP or coordinated external axes are used then this argument must be specified.

Signal

Data type: signalao

The name of the analog output signal to be changed.

Value

Data type: num

The desired value of signal.

[\TLoad]

Total load

Data type: loaddata

The \TLoad argument describes the total load used in the movement. The total load is the tool load together with the payload that the tool is carrying. If the \TLoad argument is used, then the loaddata in the current tooldata is not considered.

If the \TLoad argument is set to load0, then the \TLoad argument is not considered and the loaddata in the current tooldata is used instead.

To be able to use the \TLoad argument it is necessary to set the value of the system parameter ModalPayloadMode to 0. If ModalPayloadMode is set to 0, it is no longer possible to use the instruction GripLoad.

The total load can be identified with the service routine LoadIdentify. If the system parameter ModalPayloadMode is set to 0, the operator has the possibility to copy

Continues on next page

1.152 MoveJAO - Moves the robot by joint movement and sets analog output in the corner RobotWare Base Continued

the `loaddata` from the tool to an existing or new `loaddata` persistent variable when running the service routine.

It is possible to test run the program without any payload by using a digital input signal connected to the system input `SimMode` (Simulated Mode). If the digital input signal is set to 1, the `loaddata` in the optional argument `\TLoad` is not considered, and the `loaddata` in the current `tooldata` is used instead.



Note

The default functionality to handle payload is to use the instruction `GripLoad`. Therefore the default value of the system parameter `ModalPayLoadMode` is 1.

Program execution

See the instruction `MoveJ` for more information about joint movement, [MoveJ - Moves the robot by joint movement on page 434](#).

The analog output signal is set in the middle of the corner path for flying points, as shown in figure below.

The figure shows set of analog output signal in the corner path with `MoveJAO`.

```
MoveJAO p2, vmax, z30, tool2, aol, 1.1;
```

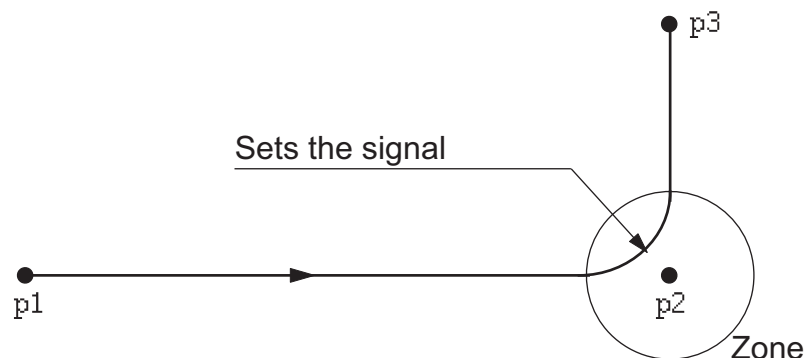

xx1400001118

For stop points we recommend the use of "normal" programming sequence with `MoveJ` and `SetAO`. But when using stop point in instruction `MoveJAO`, the analog output signal is set when the robot reaches the stop point.

The specified I/O signal is set in execution mode continuously and stepwise forward, but not in stepwise backward.

Error handling

The following recoverable errors are generated and can be handled in an error handler. The system variable `ERRNO` will be set to:

Name	Cause of error
<code>ERR_AO_LIM</code>	The programmed <code>Value</code> argument for the specified analog output signal <code>Signal</code> is outside limits.
<code>ERR_NO_ALIASIO_DEF</code>	The signal variable is a variable declared in RAPID. It has not been connected to an I/O signal defined in the I/O configuration with instruction <code>AliasIO</code> .

Continues on next page

1 Instructions

1.152 MoveJAO - Moves the robot by joint movement and sets analog output in the corner

RobotWare Base

Continued

Name	Cause of error
ERR_NORUNUNIT	There is no contact with the I/O device.
ERR_SIG_NOT_VALID	The I/O signal cannot be accessed. The reasons can be that the I/O device is not running or an error in the configuration (only valid for ICI field bus).

Limitations

MoveJAO cannot be executed in an UNDO handler or RAPID routine connected to any of the following special system events: PowerOn, Stop, QStop, Restart, Reset or Step.

Syntax

```
MoveJAO
  [ToPoint ':='] <expression (IN) of robtarg>
  ['\ ' ID ':='] <expression (IN) of identno>','
  [Speed ':='] <expression (IN) of speeddata>
  [['\ ' T ':='] <expression (IN) of num>'],'
  [Zone ':='] <expression (IN) of zonedata>','
  [Tool ':='] <persistent (PERS) of tooldata>
  ['\ ' WObj ':='] <persistent (PERS) of wobjdata>'],'
  [Signal ':='] <variable (VAR) of signalao>'],'
  [Value ':='] <expression (IN) of num>
  ['\ ' TLoad ':='] <persistent (PERS) of loaddata>'],';
```

Related information

For information about	See
Other positioning instructions	<i>Technical reference manual - RAPID Overview</i>
Moves the robot by joint movement	MoveJ - Moves the robot by joint movement on page 434
Definition of load	loaddata - Load data on page 1682
Definition of velocity	speeddata - Speed data on page 1751
Definition of tools	tooldata - Tool data on page 1776
Definition of work objects	wobjdata - Work object data on page 1803
Definition of zone data	zonedata - Zone data on page 1811
Motion in general	<i>Technical reference manual - RAPID Overview</i>
Coordinate systems	<i>Technical reference manual - RAPID Overview</i>
Movements with I/O settings	<i>Technical reference manual - RAPID Overview</i>
Example of how to use TLoad, Total Load.	MoveL - Moves the robot linearly on page 458
Defining the payload for a robot	GripLoad - Defines the payload for a robot on page 243
LoadIdentify, load identification service routine	<i>Operating manual - IRC5 with FlexPendant</i>
System input signal SimMode for running the robot in simulated mode without payload.	<i>Technical reference manual - System parameters</i>

Continues on next page

1.152 MoveJAO - Moves the robot by joint movement and sets analog output in the corner

RobotWare Base

Continued

For information about	See
System parameter <i>ModalPayload-Mode</i> for activating and deactivating payload.	<i>Technical reference manual - System parameters</i>

1 Instructions

1.153 MoveJDO - Moves the robot by joint movement and sets digital output in the corner
RobotWare Base

1.153 MoveJDO - Moves the robot by joint movement and sets digital output in the corner

Usage

MoveJDO (*Move Joint Digital Output*) is used to move the robot quickly from one point to another when that movement does not have to be in a straight line. The specified digital output signal is set/reset at the middle of the corner path.

The robot and external axes move to the destination position along a non-linear path. All axes reach the destination position at the same time.

This instruction can only be used in the main task T_ROB1 or, if in a *MultiMove* system, in Motion tasks.

Basic examples

The following example illustrates the instruction MoveJDO:

Example 1

```
MoveJDO p1, vmax, z30, tool2, do1, 1;
```

The tool center point (TCP) of the tool, tool2, is moved along a non-linear path to the position, p1, with speed data vmax and zone data z30. Output do1 is set in the middle of the corner path at p1.

Arguments

```
MoveJDO ToPoint [\ID] Speed [\T] Zone Tool [\WObj] Signal Value  
[\TLoad]
```

ToPoint

Data type: robtarget

The destination point of the robot and external axes. It is defined as a named position or stored directly in the instruction (marked with an * in the instruction).

[\ID]

Synchronization id

Data type: identno

The argument [\ID] is mandatory in the MultiMove systems, if the movement is synchronized or coordinated synchronized. This argument is not allowed in any other case. The specified id number must be the same in all the cooperating program tasks. By using the id number the movements are not mixed up at the runtime.

Speed

Data type: speeddata

The speed data that applies to movements. Speed data defines the velocity of the tool center point, the tool reorientation, and external axes.

[\T]

Time

Data type: num

Continues on next page

1.153 MoveJDO - Moves the robot by joint movement and sets digital output in the corner *RobotWare Base* *Continued*

This argument is used to specify the total time in seconds during which the robot moves. It is substituted for the corresponding speed data. The speed data is computed under the assumption that the speed is constant during the movement. If the robot cannot keep this speed during the whole movement, for example, when the movement starts from a finepoint or ends in a finepoint, the actual movement time will be larger than the programmed time.

Zone

Data type: zonedata

Zone data for the movement. Zone data describes the size of the generated corner path.

Tool

Data type: tooldata

The tool in use when the robot moves. The tool center point is the point moved to the specified destination point.

[\WObj]

Work Object

Data type: wobjdata

The work object (coordinate system) to which the robot position in the instruction is related.

This argument can be omitted and if so then the position is related to the world coordinate system. If, on the other hand, a stationary TCP or coordinated external axes are used then this argument must be specified.

Signal

Data type: signaldo

The name of the digital output signal to be changed.

Value

Data type: dionum

The desired value of signal (0 or 1).

[\TLoad]

Total load

Data type: loaddata

The \TLoad argument describes the total load used in the movement. The total load is the tool load together with the payload that the tool is carrying. If the \TLoad argument is used, then the loaddata in the current tooldata is not considered.

If the \TLoad argument is set to load0, then the \TLoad argument is not considered and the loaddata in the current tooldata is used instead.

To be able to use the \TLoad argument it is necessary to set the value of the system parameter ModalPayLoadMode to 0. If ModalPayLoadMode is set to 0, it is no longer possible to use the instruction GripLoad.

The total load can be identified with the service routine LoadIdentify. If the system parameter ModalPayLoadMode is set to 0, the operator has the possibility to copy

Continues on next page

1 Instructions

1.153 MoveJDO - Moves the robot by joint movement and sets digital output in the corner

RobotWare Base

Continued

the `loaddata` from the tool to an existing or new `loaddata` persistent variable when running the service routine.

It is possible to test run the program without any payload by using a digital input signal connected to the system input `SimMode` (Simulated Mode). If the digital input signal is set to 1, the `loaddata` in the optional argument `\TLoad` is not considered, and the `loaddata` in the current `tooldata` is used instead.



Note

The default functionality to handle payload is to use the instruction `GripLoad`. Therefore the default value of the system parameter `ModalPayloadMode` is 1.

Program execution

See the instruction `MoveJ` for more information about joint movement.

The digital output signal is set/reset in the middle of the corner path for flying points, as shown in figure below.

The figure shows set/reset of digital output signal in the corner path with `MoveJDO`.

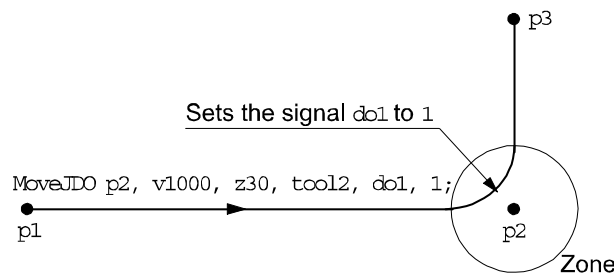

xx0500002196

For stop points we recommend the use of “normal” programming sequence with `MoveJ + SetDO`. But when using stop point in instruction `MoveJDO`, the digital output signal is set/reset when the robot reaches the stop point.

The specified I/O signal is set/reset in execution mode continuously and stepwise forward, but not in stepwise backward.

Error handling

The following recoverable errors are generated and can be handled in an error handler. The system variable `ERRNO` will be set to:

Name	Cause of error
<code>ERR_NO_ALIASIO_DEF</code>	The signal variable is a variable declared in RAPID. It has not been connected to an I/O signal defined in the I/O configuration with instruction <code>AliasIO</code> .
<code>ERR_NORUNUNIT</code>	There is no contact with the I/O device.
<code>ERR_SIG_NOT_VALID</code>	The I/O signal cannot be accessed. The reasons can be that the I/O device is not running or an error in the configuration (only valid for ICI field bus).

Continues on next page

1.153 MoveJDO - Moves the robot by joint movement and sets digital output in the corner

RobotWare Base

Continued

Limitations

MoveJDO cannot be executed in an UNDO handler or RAPID routine connected to any of the following special system events: PowerOn, Stop, QStop, Restart, Reset or Step.

Syntax

```
MoveJDO
[ ToPoint ':=' ] < expression (IN) of robtarget >
[ '\ ID ':=' < expression (IN) of identno > ] ','
[ Speed ':=' ] < expression (IN) of speeddata >
| [ '\ T ':=' < expression (IN) of num > ] ','
[ Zone ':=' ] < expression (IN) of zonedata > ','
[ Tool ':=' ] < persistent (PERS) of tooldata >
[ '\ WObj ':=' < persistent (PERS) of wobjdata > ] ','
[ Signal ':=' ] < variable (VAR) of signaldo > ','
[ Value ':=' ] < expression (IN) of dionum > ]
[ '\ TLoad ':=' < persistent (PERS) of loaddata > ] ';'

```

Related information

For information about	See
Other positioning instructions	<i>Technical reference manual - RAPID Overview</i>
Moves the robot by joint movement	MoveJ - Moves the robot by joint movement on page 434
Definition of load	loaddata - Load data on page 1682
Definition of velocity	speeddata - Speed data on page 1751
Definition of tools	tooldata - Tool data on page 1776
Definition of work objects	wobjdata - Work object data on page 1803
Definition of zone data	zonedata - Zone data on page 1811
Motion in general	<i>Technical reference manual - RAPID Overview</i>
Coordinate systems	<i>Technical reference manual - RAPID Overview</i>
Movements with I/O settings	<i>Technical reference manual - RAPID Overview</i>
Example of how to use TLoad, Total Load.	MoveL - Moves the robot linearly on page 458
Defining the payload for a robot	GripLoad - Defines the payload for a robot on page 243
LoadIdentify, load identification service routine	<i>Operating manual - IRC5 with FlexPendant</i>
System input signal <i>SimMode</i> for running the robot in simulated mode without payload.	<i>Technical reference manual - System parameters</i>
System parameter <i>ModalPayLoad-Mode</i> for activating and deactivating payload.	<i>Technical reference manual - System parameters</i>

1 Instructions

1.154 MoveJGO - Moves the robot by joint movement and set a group output signal in the corner
RobotWare Base

1.154 MoveJGO - Moves the robot by joint movement and set a group output signal in the corner

Usage

MoveJGO (*Move Joint Group Output*) is used to move the robot quickly from one point to another when that movement does not have to be in a straight line. The specified group output signal is set at the middle of the corner path.

The robot and external axes move to the destination position along a non-linear path. All axes reach the destination position at the same time.

This instruction can only be used in the main task T_ROB1 or, if in a *MultiMove* system, in Motion tasks.

Basic examples

The following example illustrates the instruction MoveJGO:

Example 1

```
MoveJGO p1, vmax, z30, tool2, go1 \Value:=5;
```

The tool center point (TCP) of the tool, tool2, is moved along a non-linear path to the position, p1, with speed data vmax and zone data z30. Group output signal go1 is set in the middle of the corner path at p1.

Arguments

```
MoveJGO ToPoint [\ID] Speed [\T] Zone Tool [\WObj] Signal [\Value]  
| [\DValue] [\TLoad]
```

ToPoint

Data type: robtarget

The destination point of the robot and external axes. It is defined as a named position or stored directly in the instruction (marked with an * in the instruction).

[\ID]

Synchronization id

Data type: identno

The argument [\ID] is mandatory in the MultiMove systems, if the movement is synchronized or coordinated synchronized. This argument is not allowed in any other case. The specified id number must be the same in all the cooperating program tasks. By using the id number the movements are not mixed up at the runtime.

Speed

Data type: speeddata

The speed data that applies to movements. Speed data defines the velocity of the tool center point, the tool reorientation, and external axes.

[\T]

Time

Data type: num

Continues on next page

1.154 MoveJGO - Moves the robot by joint movement and set a group output signal in the corner

RobotWare Base

Continued

This argument is used to specify the total time in seconds during which the robot moves. It is substituted for the corresponding speed data. The speed data is computed under the assumption that the speed is constant during the movement. If the robot cannot keep this speed during the whole movement, for example, when the movement starts from a finepoint or ends in a finepoint, the actual movement time will be larger than the programmed time.

Zone

Data type: zonedata

Zone data for the movement. Zone data describes the size of the generated corner path.

Tool

Data type: tooldata

The tool in use when the robot moves. The tool center point is the point moved to the specified destination point.

[\WObj]

Work Object

Data type: wobjdata

The work object (coordinate system) to which the robot position in the instruction is related.

This argument can be omitted and if so then the position is related to the world coordinate system. If, on the other hand, a stationary TCP or coordinated external axes are used then this argument must be specified.

Signal

Data type: signalgo

The name of the group output signal to be changed.

[\Value]

Data type: num

The desired value of signal.

[\DValue]

Data type: dnum

The desired value of signal.

If none of the arguments \Value or \DValue is entered, an error message will be displayed.

[\TLoad]

Total load

Data type: loaddata

The \TLoad argument describes the total load used in the movement. The total load is the tool load together with the payload that the tool is carrying. If the \TLoad argument is used, then the loaddata in the current tooldata is not considered.

Continues on next page

1 Instructions

1.154 MoveJGO - Moves the robot by joint movement and set a group output signal in the corner RobotWare Base Continued

If the `\TLoad` argument is set to `load0`, then the `\TLoad` argument is not considered and the `loaddata` in the current `tooldata` is used instead.

To be able to use the `\TLoad` argument it is necessary to set the value of the system parameter `ModalPayloadMode` to 0. If `ModalPayloadMode` is set to 0, it is no longer possible to use the instruction `GripLoad`.

The total load can be identified with the service routine `LoadIdentify`. If the system parameter `ModalPayloadMode` is set to 0, the operator has the possibility to copy the `loaddata` from the tool to an existing or new `loaddata` persistent variable when running the service routine.

It is possible to test run the program without any payload by using a digital input signal connected to the system input `SimMode` (Simulated Mode). If the digital input signal is set to 1, the `loaddata` in the optional argument `\TLoad` is not considered, and the `loaddata` in the current `tooldata` is used instead.



Note

The default functionality to handle payload is to use the instruction `GripLoad`. Therefore the default value of the system parameter `ModalPayloadMode` is 1.

Program execution

See the instruction `MoveJ` for more information about joint movement.

The group output signal is set in the middle of the corner path for flying points, as shown in figure below.

The figure shows set of group output signal in the corner path with `MoveJGO`.

```
MoveJGO p2, vmax, z30, tool2, go1 \Value:=5;
```

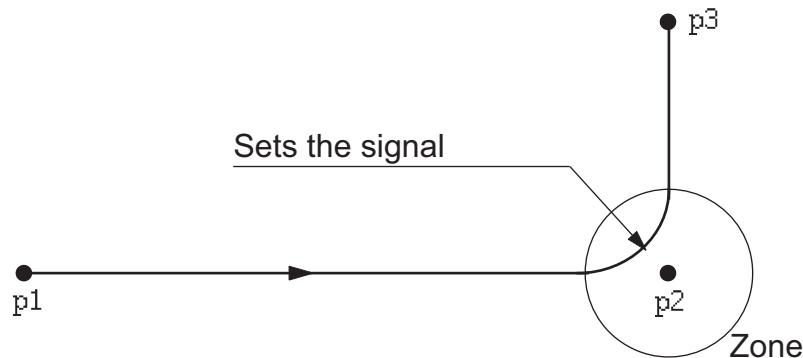

xx1400001118

For stop points we recommend the use of "normal" programming sequence with `MoveJ + SetGO`. But when using stop point in instruction `MoveJGO`, the group output signal is set when the robot reaches the stop point.

The specified I/O signal is set in execution mode continuously and stepwise forward, but not in stepwise backward.

Continues on next page

1.154 MoveJGO - Moves the robot by joint movement and set a group output signal in the corner

*RobotWare Base
Continued*

Error handling

The following recoverable errors are generated and can be handled in an error handler. The system variable `ERRNO` will be set to:

Name	Cause of error
<code>ERR_GO_LIM</code>	Value or <code>DValue</code> argument for the specified group output signal is outside limits.
<code>ERR_NO_ALIASIO_DEF</code>	The signal variable is a variable declared in RAPID. It has not been connected to an I/O signal defined in the I/O configuration with instruction <code>AliasIO</code> .
<code>ERR_NORUNUNIT</code>	there is no contact with the I/O device.
<code>ERR_SIG_NOT_VALID</code>	The I/O signal cannot be accessed. The reasons can be that the I/O device is not running or an error in the configuration (only valid for ICI field bus).

Limitations

`MoveJGO` cannot be executed in an UNDO handler or RAPID routine connected to any of the following special system events: `PowerOn`, `Stop`, `QStop`, `Restart`, `Reset` or `Step`.

Syntax

```

MoveJGO
  [ ToPoint ':' := ' ] < expression (IN) of robtarget >
  [ '\ ID ':' := ' < expression (IN) of identno > ] ', '
  [ Speed ':' := ' ] < expression (IN) of speeddata >
  | [ '\ T ':' := ' < expression (IN) of num > ] ', '
  [ Zone ':' := ' ] < expression (IN) of zonedata > ', '
  [ Tool ':' := ' ] < persistent (PERS) of tooldata >
  [ '\ WObj ':' := ' < persistent (PERS) of wobjdata > ] ', '
  [ Signal ':' := ' ] < variable (VAR) of signalgo > ] ', '
  [ '\ Value ':' := ' ] < expression (IN) of num > ]
  | [ '\ Dvalue ':' := ' ] < expression (IN) of dnum >
  [ '\ TLoad ':' := ' < persistent (PERS) of loaddata > ] '; '

```

Related information

For information about	See
Other positioning instructions	<i>Technical reference manual - RAPID Overview</i>
Moves the robot by joint movement	MoveJ - Moves the robot by joint movement on page 434
Definition of load	loaddata - Load data on page 1682
Definition of velocity	speeddata - Speed data on page 1751
Definition of tools	tooldata - Tool data on page 1776
Definition of work objects	wobjdata - Work object data on page 1803
Definition of zone data	zonedata - Zone data on page 1811
Motion in general	<i>Technical reference manual - RAPID Overview</i>
Coordinate systems	<i>Technical reference manual - RAPID Overview</i>

Continues on next page

1 Instructions

1.154 MoveJGO - Moves the robot by joint movement and set a group output signal in the corner

RobotWare Base

Continued

For information about	See
Movements with I/O settings	<i>Technical reference manual - RAPID Overview</i>
Example of how to use <code>TLoad</code> , Total Load.	MoveL - Moves the robot linearly on page 458
Defining the payload for a robot	GripLoad - Defines the payload for a robot on page 243
LoadIdentify, load identification service routine	<i>Operating manual - IRC5 with FlexPendant</i>
System input signal <code>SimMode</code> for running the robot in simulated mode without payload.	<i>Technical reference manual - System parameters</i>
System parameter <code>ModalPayload-Mode</code> for activating and deactivating payload.	<i>Technical reference manual - System parameters</i>

1.155 MoveJSync - Moves the robot by joint movement and executes a RAPID procedure

Usage

`MoveJSync` (*Move Joint Synchronously*) is used to move the robot quickly from one point to another when that movement does not have to be in a straight line. The specified RAPID procedure is ordered to execute at the middle of the corner path in the destination point.

The robot and external axes move to the destination position along a non-linear path. All axes reach the destination position at the same time.

This instruction can only be used in the main task `T_ROB1` or, if in a *MultiMove* system, in Motion tasks.

Basic examples

The following examples illustrate the instruction `MoveJSync`:

Example 1

```
MoveJSync p1, vmax, z30, tool2, "proc1";
```

The tool center point (TCP) of the tool, `tool2`, is moved along a non-linear path to the position, `p1`, with speed data `vmax` and zone data `z30`. Procedure `proc1` is executed in the middle of the corner path at `p1`.

Example 2

```
MoveJSync p1, vmax, z30, tool2, "MyModule:proc1";
```

The same as in example 1 above, but here the locally declared procedure `proc1` in module `MyModule` will be called in the middle of the corner path.

Arguments

```
MoveJSync ToPoint [\ID] Speed [\T] Zone Tool [\WObj] ProcName
[\TLoad]
```

ToPoint

Data type: `robtarget`

The destination point of the robot and external axes. It is defined as a named position or stored directly in the instruction (marked with an * in the instruction).

[\ID]

Synchronization id

Data type: `identno`

The argument [\ID] is mandatory in *MultiMove* systems, if the movement is synchronized or coordinated synchronized. This argument is not allowed in any other case. The specified id number must be the same in all the cooperating program tasks. By using the id number the movements are not mixed up at the runtime.

Speed

Data type: `speeddata`

Continues on next page

1 Instructions

1.155 MoveJSync - Moves the robot by joint movement and executes a RAPID procedure

RobotWare Base

Continued

The speed data that applies to movements. Speed data defines the velocity of the TCP, the tool reorientation, and external axes.

[\T]

Time

Data type: num

This argument is used to specify the total time in seconds during which the robot moves. It is substituted for the corresponding speed data. The speed data is computed under the assumption that the speed is constant during the movement. If the robot cannot keep this speed during the whole movement, for example, when the movement starts from a finepoint or ends in a finepoint, the actual movement time will be larger than the programmed time.

Zone

Data type: zonedata

Zone data for the movement. Zone data describes the size of the generated corner path.

Tool

Data type: tooldata

The tool in use when the robot moves. The tool center point is the point that is moved to the specified destination point.

[\WObj]

Work Object

Data type: wobjdata

The work object (object coordinate system) to which the robot position in the instruction is related.

This argument can be omitted and if it is then the position is related to the world coordinate system. If, on the other hand, a stationary TCP or coordinated external axes are used this argument must be specified in order for a circle relative to the work object to be executed.

ProcName

Procedure Name

Data type: string

Name of the RAPID procedure to be executed at the middle of the corner path in the destination point. The procedure call is a late binding call, and therefore inherits its properties.

The procedure will execute on trap level (see [Program execution on page 455](#)).

[\TLoad]

Total load

Data type: loaddata

The \TLoad argument describes the total load used in the movement. The total load is the tool load together with the payload that the tool is carrying. If the \TLoad argument is used, then the loaddata in the current tooldata is not considered.

Continues on next page

1.155 MoveJSync - Moves the robot by joint movement and executes a RAPID procedure RobotWare Base Continued

If the `\TLoad` argument is set to `load0`, then the `\TLoad` argument is not considered and the `loaddata` in the current `tooldata` is used instead.

To be able to use the `\TLoad` argument it is necessary to set the value of the system parameter `ModalPayLoadMode` to 0. If `ModalPayLoadMode` is set to 0, it is no longer possible to use the instruction `GripLoad`.

The total load can be identified with the service routine `LoadIdentify`. If the system parameter `ModalPayLoadMode` is set to 0, the operator has the possibility to copy the `loaddata` from the tool to an existing or new `loaddata` persistent variable when running the service routine.

It is possible to test run the program without any payload by using a digital input signal connected to the system input `SimMode` (Simulated Mode). If the digital input signal is set to 1, the `loaddata` in the optional argument `\TLoad` is not considered, and the `loaddata` in the current `tooldata` is used instead.



Note

The default functionality to handle payload is to use the instruction `GripLoad`. Therefore the default value of the system parameter `ModalPayLoadMode` is 1.

Program execution

See the instruction `MoveJ` for more information about joint movements.

The specified RAPID procedure is ordered to execute when the TCP reaches the middle of the corner path in the destination point of the `MoveJSync` instruction, as shown in the figure

below.

```
MoveJSync p2, v1000, z30, tool2, "my_proc";
```

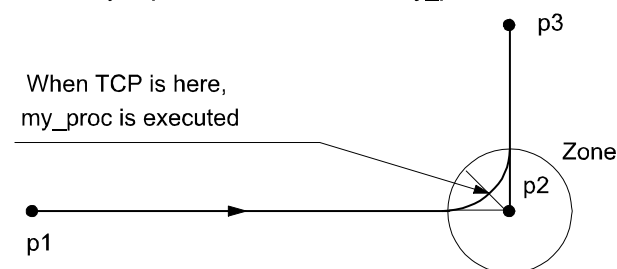

xx0500002195

For stop points we recommend the use of “normal” programming sequence with `MoveJ` + other RAPID instructions in sequence.

The table describes execution of the specified RAPID procedure in different execution modes:

Execution mode	Execution of RAPID procedure
Continuously or Cycle	According to this description
Forward step	In the stop point
Backward step	Not at all

Continues on next page

1 Instructions

1.155 MoveJSync - Moves the robot by joint movement and executes a RAPID procedure

RobotWare Base

Continued

MoveJSync is an encapsulation of the instructions TriggInt and TriggJ. The procedure call is executed on trap level.

If the middle of the corner path in the destination point is reached during the deceleration after a program stop, the procedure will not be called (program execution is stopped). The procedure call will be executed at next program start.

Limitations

When the robot reaches the middle of the corner path there is normally a delay of 2-30 ms until the specified RAPID routine is executed, depending on what type of movement is being performed at the time.

Switching execution mode after program stop from continuously or cycle to stepwise forward or backward results in an error. This error tells the user that the mode switch can result in missed execution of the RAPID procedure in the queue for execution on the path.

Instruction MoveJSync cannot be used on trap level. The specified RAPID procedure cannot be tested with stepwise execution.

MoveJSync cannot be executed in an UNDO handler or RAPID routine connected to any of the following special system events: PowerOn, Stop, QStop, Restart, Reset or Step.

Syntax

```
MoveJSync
[ ToPoint ':=' ] < expression (IN) of robtarget >
[ '\ ID ':=' < expression (IN) of identno > ] ', '
[ Speed ':=' ] < expression (IN) of speeddata >
| [ '\ T ':=' < expression (IN) of num > ] ', '
[ Zone ':=' ] < expression (IN) of zonedata > ', '
[ Tool ':=' ] < persistent (PERS) of tooldata >
[ '\ WObj '=' < persistent (PERS) of wobjdata > ] ', '
[ ProcName '=' ] < expression (IN) of string > ]
[ '\ TLoad ':=' < persistent (PERS) of loaddata > ] ';' ;'
```

Related information

For information about	See
Other positioning instructions	<i>Technical reference manual - RAPID Overview</i>
Moves the robot by joint movement	MoveJ - Moves the robot by joint movement on page 434
Definition of load	loaddata - Load data on page 1682
Definition of velocity	speeddata - Speed data on page 1751
Definition of tools	tooldata - Tool data on page 1776
Definition of work objects	wobjdata - Work object data on page 1803
Definition of zone data	zonedata - Zone data on page 1811
Motion in general	<i>Technical reference manual - RAPID Overview</i>
Coordinate systems	<i>Technical reference manual - RAPID Overview</i>

Continues on next page

1.155 MoveJSync - Moves the robot by joint movement and executes a RAPID procedure

RobotWare Base

Continued

For information about	See
Defines a position related interrupt	TriggInt - Defines a position related interrupt on page 916
Axis-wise robot movements with events	TriggJ - Axis-wise robot movements with events on page 927
Example of how to use <code>TLoad</code> , Total Load.	MoveL - Moves the robot linearly on page 458
Defining the payload for a robot	GripLoad - Defines the payload for a robot on page 243
LoadIdentify, load identification service routine	Operating manual - IRC5 with FlexPendant
System input signal <code>SimMode</code> for running the robot in simulated mode without payload.	Technical reference manual - System parameters
System parameter <code>ModalPayloadMode</code> for activating and deactivating payload.	Technical reference manual - System parameters

1 Instructions

1.156 MoveL - Moves the robot linearly
RobotWare Base

1.156 MoveL - Moves the robot linearly

Usage

MoveL is used to move the tool center point (TCP) linearly to a given destination. When the TCP is to remain stationary then this instruction can also be used to reorientate the tool.

This instruction can only be used in the main task T_ROB1 or, if in a MultiMove System, in Motion tasks.

Basic examples

The following examples illustrate the instruction MoveL:

See also [More examples on page 461](#).

Example 1

```
MoveL p1, v1000, z30, tool2;
```

The TCP of the tool, tool2, is moved linearly to the position p1, with speed data v1000 and zone data z30.

Example 2

```
MoveL *, v1000\T:=5, fine, grip3;
```

The TCP of the tool, grip3, is moved linearly to a stop point stored in the instruction (marked with an *). The complete movement takes 5 seconds.

Arguments

```
MoveL [\Conc] ToPoint [\ID] Speed [\V] | [ \T] Zone [\Z] [\Inpos]  
Tool [\WObj] [\Corr] [\TLoad]
```

[\Conc]

Concurrent

Data type: switch

Subsequent instructions are executed while the robot is moving. The argument is usually not used but can be used to avoid unwanted stops caused by overloaded CPU when using fly-by points. This is useful when the programmed points are very close together at high speeds. The argument is also useful when, for example, communicating with external equipment and synchronization between the external equipment and robot movement is not required.

Using the argument \Conc, the number of movement instructions in succession is limited to 5. In a program section that includes StorePath-Restopath, movement instructions with the argument \Conc are not permitted.

If this argument is omitted and the ToPoint is not a stop point then the subsequent instruction is executed some time before the robot has reached the programmed zone.

This argument cannot be used in coordinated synchronized movement in a MultiMove System.

ToPoint

Data type: robtarget

Continues on next page

The destination point of the robot and external axes. It is defined as a named position or stored directly in the instruction (marked with an * in the instruction).

[\ID]

Synchronization id

Data type: identno

The argument [\ID] is mandatory in the MultiMove systems, if the movement is synchronized or coordinated synchronized. This argument is not allowed in any other case. The specified id number must be the same in all the cooperating program tasks. By using the id number the movements are not mixed up at the runtime.

Speed

Data type: speeddata

The speed data that applies to movements. Speed data defines the velocity for the tool center point, the tool reorientation, and external axes.

[\V]

Velocity

Data type: num

This argument is used to specify the velocity of the TCP in mm/s directly in the instruction. It is then substituted for the corresponding velocity specified in the speed data.

[\T]

Time

Data type: num

This argument is used to specify the total time in seconds during which the robot moves. It is substituted for the corresponding speed data. The speed data is computed under the assumption that the speed is constant during the movement. If the robot cannot keep this speed during the whole movement, for example, when the movement starts from a finepoint or ends in a finepoint, the actual movement time will be larger than the programmed time.

Zone

Data type: zonedata

Zone data for the movement. Zone data describes the size of the generated corner path.

[\Z]

Zone

Data type: num

This argument is used to specify the position accuracy of the robot TCP directly in the instruction. The length of the corner path is given in mm, which is substituted for the corresponding zone specified in the zone data.

[\Inpos]

In position

Continues on next page

1 Instructions

1.156 MoveL - Moves the robot linearly

RobotWare Base

Continued

Data type: stoppointdata

This argument is used to specify the convergence criteria for the position of the robot's TCP in the stop point. The stop point data substitutes the zone specified in the `Zone` parameter.

`Tool`

Data type: tooldata

The tool in use when the robot moves. The tool center point is the point moved to the specified destination position.

`[\WObj]`

Work Object

Data type: wobjdata

The work object (coordinate system) to which the robot position in the instruction is related.

This argument can be omitted and if so then the position is related to the world coordinate system. If, on the other hand, a stationary tool or coordinated external axes are used then this argument must be specified to perform a linear movement relative to the work object.

`[\Corr]`

Correction

Data type: switch

Correction data written to a corrections entry by the instruction `CorrWrite` will be added to the path and destination position if this argument is present.

The RobotWare option *Path Offset* is required when using this argument.

`[\TLoad]`

Total load

Data type: loaddata

The `\TLoad` argument describes the total load used in the movement. The total load is the tool load together with the payload that the tool is carrying. If the `\TLoad` argument is used, then the `loaddata` in the current `tooldata` is not considered.

If the `\TLoad` argument is set to `load0`, then the `\TLoad` argument is not considered and the `loaddata` in the current `tooldata` is used instead.

To be able to use the `\TLoad` argument it is necessary to set the value of the system parameter `ModalPayloadMode` to 0. If `ModalPayloadMode` is set to 0, it is no longer possible to use the instruction `GripLoad`.

The total load can be identified with the service routine `LoadIdentify`. If the system parameter `ModalPayloadMode` is set to 0, the operator has the possibility to copy the `loaddata` from the tool to an existing or new `loaddata` persistent variable when running the service routine.

It is possible to test run the program without any payload by using a digital input signal connected to the system input `SimMode` (Simulated Mode). If the digital

Continues on next page

input signal is set to 1, the `loaddata` in the optional argument `\TLoad` is not considered, and the `loaddata` in the current `tooldata` is used instead.

**Note**

The default functionality to handle payload is to use the instruction `GripLoad`. Therefore the default value of the system parameter `ModalPayloadMode` is 1.

Program execution

The robot and external units are moved to the destination position as follows:

- The TCP of the tool is moved linearly at constant programmed velocity.
- The tool is reoriented at equal intervals along the path.
- Uncoordinated external axes are executed at a constant velocity in order for them to arrive at the destination point at the same time as the robot axes.

If it is not possible to attain the programmed velocity for the reorientation or for the external axes then the velocity of the TCP will be reduced.

A corner path is usually generated when movement is transferred to the next section of a path. If a stop point is specified in the zone data then program execution only continues when the robot and external axes have reached the appropriate position.

Error handling

The following recoverable errors are generated and can be handled in an error handler. The system variable `ERRNO` will be set to:

Name	Cause of error
<code>ERR_CONC_MAX</code>	The number of movement instructions in succession using argument <code>\Conc</code> has been exceeded.

More examples

More examples of how to use the instruction `MoveL` are illustrated below.

Example 1

```
MoveL *, v2000 \V:=2200, z40 \Z:=45, grip3;
```

The TCP of the tool, `grip3`, is moved linearly to a position stored in the instruction. The movement is carried out with data set to `v2000` and `z40`. The velocity and zone size of the TCP are 2200 mm/s and 45 mm respectively.

Example 2

```
MoveL p5, v2000, fine \Inpos := inpos50, grip3;
```

The TCP of the tool, `grip3`, is moved linearly to a stop point `p5`. The robot considers it to be in the point when 50% of the position condition and 50% of the speed condition for a stop point `fine` are satisfied. It waits at most for 2 seconds for the conditions to be satisfied. See predefined data `inpos50` of data type `stoppointdata`.

Example 3

```
MoveL \Conc, *, v2000, z40, grip3;
```

Continues on next page

1 Instructions

1.156 MoveL - Moves the robot linearly

RobotWare Base

Continued

The TCP of the tool, `grip3`, is moved linearly to a position stored in the instruction. Subsequent logical instructions are executed while the robot moves.

Example 4

```
MoveL start, v2000, z40, grip3 \WObj:=fixture;
```

The TCP of the tool, `grip3`, is moved linearly to a position, `start`. This position is specified in the object coordinate system for `fixture`.

Example with TLoad

```
MoveL p1, v1000, fine, tool2;  
! Pick up the payload  
Set gripperdo;  
MoveL p2, v1000, z30, tool2 \TLoad:=tool2piece;  
MoveL p3, v1000, fine, tool2 \TLoad:=tool2piece;  
! Release the payload  
Reset gripperdo;  
MoveL p4, v1000, fine, tool2;
```

The TCP of the tool, `tool2`, is moved linearly to position `p1` where a payload is picked up. From that position the TCP is moved to position `p2` and `p3` using the total load `tool2piece`. The loaddata in the current `tooldata` is not considered. The payload is released, and when moving to position `p4` the load of the tool is considered again.

Limitations

`MoveL` cannot be executed in an UNDO handler or RAPID routine connected to any of the following special system events: PowerOn, Stop, QStop, Restart, Reset or Step.

Syntax

```
MoveL  
[ '\ Conc ',' ]  
[ ToPoint ':=' ] < expression (IN) of robtarget >  
[ '\ ID ':=' < expression (IN) of identno > ] ','  
[ Speed ':=' ] < expression (IN) of speeddata >  
[ '\ V ':=' < expression (IN) of num > ]  
| [ '\ T ':=' < expression (IN) of num > ] ','  
[ Zone ':=' ] < expression (IN) of zonedata >  
[ '\ Z ':=' < expression (IN) of num > ]  
[ '\ Inpos ':=' < expression (IN) of stoppointdata > ] ','  
[ Tool ':=' ] < persistent (PERS) of tooldata >  
[ '\ WObj ':=' < persistent (PERS) of wobjdata > ]  
[ '\ Corr ]  
[ '\ TLoad ':=' < persistent (PERS) of loaddata > ] ';' ;
```

Related information

For information about	See
Other positioning instructions	<i>Technical reference manual - RAPID Overview</i>
Definition of load	loaddata - Load data on page 1682

Continues on next page

For information about	See
Definition of velocity	speeddata - Speed data on page 1751
Definition of stop point data	stoppointdata - Stop point data on page 1755
Definition of tools	tooldata - Tool data on page 1776
Definition of work objects	wobjdata - Work object data on page 1803
Definition of zone data	zonedata - Zone data on page 1811
Writes to a corrections entry	CorrWrite - Writes to a correction generator on page 180
Motion in general	<i>Technical reference manual - RAPID Overview</i>
Coordinate systems	<i>Technical reference manual - RAPID Overview</i>
Concurrent program execution	<i>Technical reference manual - RAPID Overview</i>
Defining the payload for a robot	GripLoad - Defines the payload for a robot on page 243
LoadIdentify, load identification service routine	<i>Operating manual - IRC5 with FlexPendant</i>
System input signal <i>SimMode</i> for running the robot in simulated mode without payload.	<i>Technical reference manual - System parameters</i>
System parameter <i>ModalPayload-Mode</i> for activating and deactivating payload.	<i>Technical reference manual - System parameters</i>
<i>Path Offset</i>	<i>Application manual - Controller software IRC5</i>

1 Instructions

1.157 MoveLAO - Moves the robot linearly and sets analog output in the corner
RobotWare Base

1.157 MoveLAO - Moves the robot linearly and sets analog output in the corner

Usage

MoveLAO (*Move Linearly Analog Output*) is used to move the tool center point (TCP) linearly to a given destination. The specified analog output signal is set at the middle of the corner path.

When the TCP is to remain stationary then this instruction can also be used to reorient the tool.

This instruction can only be used in the main task `T_ROB1` or, if in a *MultiMove* system, in Motion tasks.

Basic examples

The following example illustrates the instruction MoveLAO:

Example 1

```
MoveLAO p1, v1000, z30, tool2, a01, 1.1;
```

The TCP of the tool, `tool2`, is moved linearly to the position `p1` with speed data `v1000` and zone data `z30`. Output `a01` is set in the middle of the corner path at `p1`.

Arguments

```
MoveLAO ToPoint [\ID] Speed [\T] Zone Tool [\WObj] Signal Value  
[\TLoad]
```

ToPoint

Data type: `robtarget`

The destination point of the robot and external axes. It is defined as a named position or stored directly in the instruction (marked with an * in the instruction).

[\ID]

Synchronization id

Data type: `identno`

The argument [\ID] is mandatory in the MultiMove systems, if the movement is synchronized or coordinated synchronized. This argument is not allowed in any other case. The specified id number must be the same in all the cooperating program tasks. By using the id number the movements are not mixed up at the runtime.

Speed

Data type: `speeddata`

The speed data that applies to movements. Speed data defines the velocity for the tool center point, the tool reorientation, and external axes.

[\T]

Time

Data type: `num`

Continues on next page

1.157 MoveLAO - Moves the robot linearly and sets analog output in the corner *RobotWare Base* *Continued*

This argument is used to specify the total time in seconds during which the robot moves. It is substituted for the corresponding speed data. The speed data is computed under the assumption that the speed is constant during the movement. If the robot cannot keep this speed during the whole movement, for example, when the movement starts from a finepoint or ends in a finepoint, the actual movement time will be larger than the programmed time.

Zone

Data type: zonedata

Zone data for the movement. Zone data describes the size of the generated corner path.

Tool

Data type: tooldata

The tool in use when the robot moves. The tool center point is the point moved to the specified destination position.

[\WObj]

Work Object

Data type: wobjdata

The work object (coordinate system) to which the robot position in the instruction is related.

This argument can be omitted and if so then the position is related to the world coordinate system. If, on the other hand, a stationary TCP or coordinated external axes are used then this argument must be specified.

Signal

Data type: signalao

The name of the analog output signal to be changed.

Value

Data type: num

The desired value of signal.

[\TLoad]

Total load

Data type: loaddata

The \TLoad argument describes the total load used in the movement. The total load is the tool load together with the payload that the tool is carrying. If the \TLoad argument is used, then the loaddata in the current tooldata is not considered.

If the \TLoad argument is set to load0, then the \TLoad argument is not considered and the loaddata in the current tooldata is used instead.

To be able to use the \TLoad argument it is necessary to set the value of the system parameter ModalPayLoadMode to 0. If ModalPayLoadMode is set to 0, it is no longer possible to use the instruction GripLoad.

The total load can be identified with the service routine LoadIdentify. If the system parameter ModalPayLoadMode is set to 0, the operator has the possibility to copy

Continues on next page

1 Instructions

1.157 MoveLAO - Moves the robot linearly and sets analog output in the corner

RobotWare Base

Continued

the `loaddata` from the tool to an existing or new `loaddata` persistent variable when running the service routine.

It is possible to test run the program without any payload by using a digital input signal connected to the system input `SimMode` (Simulated Mode). If the digital input signal is set to 1, the `loaddata` in the optional argument `\TLoad` is not considered, and the `loaddata` in the current `tooldata` is used instead.



Note

The default functionality to handle payload is to use the instruction `GripLoad`. Therefore the default value of the system parameter `ModalPayLoadMode` is 1.

Program execution

See the instruction `MoveL` for more information about linear movements.

The analog output signal is set in the middle of the corner path for flying points, as shown in the figure below.

The figure shows set of analog output signal in the corner path with `MoveLAO`.

```
MoveLAO p2, v1000, z30, tool2, ao1, 1.1;
```

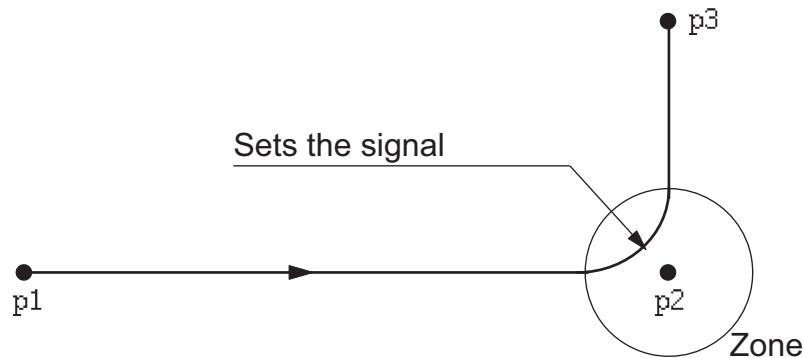

xx1400001118

For stop points we recommend the use of "normal" programming sequence with `MoveL` and `SetAO`. But when using stop point in instruction `MoveLAO`, the analog output signal is set when the robot reaches the stop point.

The specified I/O signal is set in execution mode continuously and stepwise forward, but not in stepwise backward.

Error handling

The following recoverable errors are generated and can be handled in an error handler. The system variable `ERRNO` will be set to:

Name	Cause of error
<code>ERR_AO_LIM</code>	The programmed <code>Value</code> argument for the specified analog output signal <code>Signal</code> is outside limits.
<code>ERR_NO_ALIASIO_DEF</code>	The signal variable is a variable declared in RAPID. It has not been connected to an I/O signal defined in the I/O configuration with instruction <code>AliasIO</code> .
<code>ERR_NORUNUNIT</code>	There is no contact with the I/O device.

Continues on next page

1.157 MoveLAO - Moves the robot linearly and sets analog output in the corner

RobotWare Base
Continued

Name	Cause of error
ERR_SIG_NOT_VALID	The I/O signal cannot be accessed. The reasons can be that the I/O device is not running or an error in the configuration (only valid for ICI field bus).

Limitations

MoveLAO cannot be executed in an UNDO handler or RAPID routine connected to any of the following special system events: PowerOn, Stop, QStop, Restart, Reset or Step.

Syntax

```

MoveLAO
  [ ToPoint ':= ' ] < expression (IN) of robtarget >
  [ '\ ' ID ':= ' < expression (IN) of identno > ], '
  [ Speed ':= ' ] < expression (IN) of speeddata >
  | [ '\ ' T ':= ' < expression (IN) of num > ] ', '
  [ Zone ':= ' ] < expression (IN) of zonedata > ', '
  [ Tool ':= ' ] < persistent (PERS) of tooldata >
  [ '\ ' WObj ':= ' ] < persistent (PERS) of wobjdata > ', '
  [ Signal ':= ' ] < variable (VAR) of signalao > ', '
  [ Value ':= ' ] < expression (IN) of num > ]
  [ '\ ' TLoad ':= ' < persistent (PERS) of loaddata > ] '; '

```

Related information

For information about	See
Other positioning instructions	<i>Technical reference manual - RAPID Overview</i>
Moves the robot linearly	MoveL - Moves the robot linearly on page 458
Definition of load	loaddata - Load data on page 1682
Definition of velocity	speeddata - Speed data on page 1751
Definition of tools	tooldata - Tool data on page 1776
Definition of work objects	wobjdata - Work object data on page 1803
Definition of zone data	zonedata - Zone data on page 1811
Motion in general	<i>Technical reference manual - RAPID Overview</i>
Coordinate systems	<i>Technical reference manual - RAPID Overview</i>
Movements with I/O settings	<i>Technical reference manual - RAPID Overview</i>
Example of how to use TLoad, Total Load.	MoveL - Moves the robot linearly on page 458
Defining the payload for a robot	GripLoad - Defines the payload for a robot on page 243
LoadIdentify, load identification service routine	<i>Operating manual - IRC5 with FlexPendant</i>
System input signal SimMode for running the robot in simulated mode without payload.	<i>Technical reference manual - System parameters</i>

Continues on next page

1 Instructions

1.157 MoveLAO - Moves the robot linearly and sets analog output in the corner

RobotWare Base

Continued

For information about	See
System parameter <i>ModalPayload-Mode</i> for activating and deactivating payload.	<i>Technical reference manual - System parameters</i>

1.158 MoveLDO - Moves the robot linearly and sets digital output in the corner RobotWare Base

1.158 MoveLDO - Moves the robot linearly and sets digital output in the corner

Usage

`MoveLDO` (*Move Linearly Digital Output*) is used to move the tool center point (TCP) linearly to a given destination. The specified digital output signal is set/reset at the middle of the corner path.

When the TCP is to remain stationary then this instruction can also be used to reorient the tool.

This instruction can only be used in the main task `T_ROB1` or, if in a *MultiMove* system, in Motion tasks.

Basic examples

The following example illustrates the instruction `MoveLDO`:

Example 1

```
MoveLDO p1, v1000, z30, tool2, do1,1;
```

The TCP of the tool, `tool2`, is moved linearly to the position `p1` with speed data `v1000` and zone data `z30`. Output `do1` is set in the middle of the corner path at `p1`.

Arguments

```
MoveLDO ToPoint [\ID] Speed [\T] Zone Tool [\WObj] Signal Value
        [\TLoad]
```

ToPoint

Data type: `robtarget`

The destination point of the robot and external axes. It is defined as a named position or stored directly in the instruction (marked with an * in the instruction).

[\ID]

Synchronization id

Data type: `identno`

The argument [\ID] is mandatory in the MultiMove systems, if the movement is synchronized or coordinated synchronized. This argument is not allowed in any other case. The specified id number must be the same in all the cooperating program tasks. By using the id number the movements are not mixed up at the runtime.

Speed

Data type: `speeddata`

The speed data that applies to movements. Speed data defines the velocity for the tool center point, the tool reorientation, and external axes.

[\T]

Time

Data type: `num`

Continues on next page

1 Instructions

1.158 MoveLDO - Moves the robot linearly and sets digital output in the corner

RobotWare Base

Continued

This argument is used to specify the total time in seconds during which the robot moves. It is substituted for the corresponding speed data. The speed data is computed under the assumption that the speed is constant during the movement. If the robot cannot keep this speed during the whole movement, for example, when the movement starts from a finepoint or ends in a finepoint, the actual movement time will be larger than the programmed time.

Zone

Data type: zonedata

Zone data for the movement. Zone data describes the size of the generated corner path.

Tool

Data type: tooldata

The tool in use when the robot moves. The tool center point is the point moved to the specified destination position.

[\WObj]

Work Object

Data type: wobjdata

The work object (coordinate system) to which the robot position in the instruction is related.

This argument can be omitted and if so then the position is related to the world coordinate system. If, on the other hand, a stationary TCP or coordinated external axes are used then this argument must be specified.

Signal

Data type: signaldo

The name of the digital output signal to be changed.

Value

Data type: dionum

The desired value of signal (0 or 1).

[\TLoad]

Total load

Data type: loaddata

The \TLoad argument describes the total load used in the movement. The total load is the tool load together with the payload that the tool is carrying. If the \TLoad argument is used, then the loaddata in the current tooldata is not considered.

If the \TLoad argument is set to load0, then the \TLoad argument is not considered and the loaddata in the current tooldata is used instead.

To be able to use the \TLoad argument it is necessary to set the value of the system parameter ModalPayloadMode to 0. If ModalPayloadMode is set to 0, it is no longer possible to use the instruction GripLoad.

The total load can be identified with the service routine LoadIdentify. If the system parameter ModalPayloadMode is set to 0, the operator has the possibility to copy

Continues on next page

1.158 MoveLDO - Moves the robot linearly and sets digital output in the corner RobotWare Base Continued

the `loaddata` from the tool to an existing or new `loaddata` persistent variable when running the service routine.

It is possible to test run the program without any payload by using a digital input signal connected to the system input `SimMode` (Simulated Mode). If the digital input signal is set to 1, the `loaddata` in the optional argument `\TLoad` is not considered, and the `loaddata` in the current `tooldata` is used instead.



Note

The default functionality to handle payload is to use the instruction `GripLoad`. Therefore the default value of the system parameter `ModalPayLoadMode` is 1.

Program execution

See the instruction `MoveL` for more information about linear movements.

The digital output signal is set/reset in the middle of the corner path for flying points, as shown in the figure below.

The figure shows set/reset of digital output signal in the corner path with `MoveLDO`.

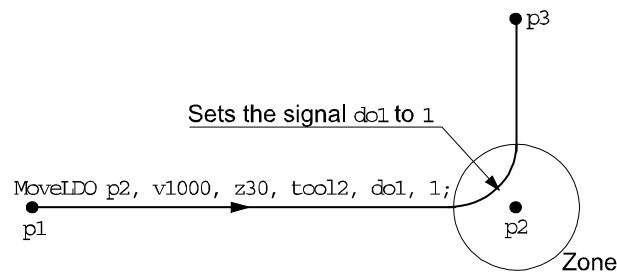

xx0500002193

For stop points we recommend the use of "normal" programming sequence with `MoveL` and `SetDO`. But when using stop point in instruction `MoveLDO`, the digital output signal is set/reset when the robot reaches the stop point.

The specified I/O signal is set/reset in execution mode continuously and stepwise forward, but not in stepwise backward.

Error handling

The following recoverable errors are generated and can be handled in an error handler. The system variable `ERRNO` will be set to:

Name	Cause of error
<code>ERR_NO_ALIASIO_DEF</code>	The signal variable is a variable declared in RAPID. It has not been connected to an I/O signal defined in the I/O configuration with instruction <code>AliasIO</code> .
<code>ERR_NORUNUNIT</code>	There is no contact with the I/O device.
<code>ERR_SIG_NOT_VALID</code>	The I/O signal cannot be accessed. The reasons can be that the I/O device is not running or an error in the configuration (only valid for ICI field bus).

Continues on next page

1 Instructions

1.158 MoveLDO - Moves the robot linearly and sets digital output in the corner

RobotWare Base

Continued

Limitations

MoveLDO cannot be executed in an UNDO handler or RAPID routine connected to any of the following special system events: PowerOn, Stop, QStop, Restart, Reset or Step.

Syntax

```
MoveLDO
[ ToPoint ':=' ] < expression (IN) of robtarget >
[ '\ ID ':=' < expression (IN) of identno > ],'
[ Speed ':=' ] < expression (IN) of speeddata >
| [ '\ T ':=' < expression (IN) of num > ] ', '
[ Zone ':=' ] < expression (IN) of zonedata > ', '
[ Tool ':=' ] < persistent (PERS) of tooldata >
[ '\ WObj ':=' ] < persistent (PERS) of wobjdata > ', '
[ Signal ':=' ] < variable (VAR) of signaldo > ', '
[ Value ':=' ] < expression (IN) of dionum > ]
[ '\ TLoad ':=' < persistent (PERS) of loaddata > ] ';'

```

Related information

For information about	See
Other positioning instructions	<i>Technical reference manual - RAPID Overview</i>
Moves the robot linearly	MoveL - Moves the robot linearly on page 458
Definition of load	loaddata - Load data on page 1682
Definition of velocity	speeddata - Speed data on page 1751
Definition of tools	tooldata - Tool data on page 1776
Definition of work objects	wobjdata - Work object data on page 1803
Definition of zone data	zonedata - Zone data on page 1811
Motion in general	<i>Technical reference manual - RAPID Overview</i>
Coordinate systems	<i>Technical reference manual - RAPID Overview</i>
Movements with I/O settings	<i>Technical reference manual - RAPID Overview</i>
Example of how to use TLoad, Total Load.	MoveL - Moves the robot linearly on page 458
Defining the payload for a robot	GripLoad - Defines the payload for a robot on page 243
LoadIdentify, load identification service routine	<i>Operating manual - IRC5 with FlexPendant</i>
System input signal SimMode for running the robot in simulated mode without payload.	<i>Technical reference manual - System parameters</i>
System parameter ModalPayLoad-Mode for activating and deactivating payload.	<i>Technical reference manual - System parameters</i>

1.159 MoveLGO - Moves the robot linearly and sets group output signal in the corner
RobotWare Base

1.159 MoveLGO - Moves the robot linearly and sets group output signal in the corner

Usage

MoveLGO (*Move Linearly Group Output*) is used to move the tool center point (TCP) linearly to a given destination. The specified group output signal is set at the middle of the corner path.

When the TCP is to remain stationary then this instruction can also be used to reorient the tool.

This instruction can only be used in the main task T_ROB1 or, if in a *MultiMove* system, in Motion tasks.

Basic examples

The following example illustrates the instruction MoveLGO:

Example 1

```
MoveLGO p1, v1000, z30, tool2, g01 \Value:=5;
```

The TCP of the tool, tool2, is moved linearly to the position p1 with speed data v1000 and zone data z30. Group output signal g01 is set in the middle of the corner path at p1.

Arguments

```
MoveLGO ToPoint [\ID] Speed [\T] Zone Tool [\WObj] Signal [\Value]
| [\DValue] [\TLoad]
```

ToPoint

Data type: robtarget

The destination point of the robot and external axes. It is defined as a named position or stored directly in the instruction (marked with an * in the instruction).

[\ID]

Synchronization id

Data type: identno

The argument [\ID] is mandatory in the MultiMove systems, if the movement is synchronized or coordinated synchronized. This argument is not allowed in any other case. The specified id number must be the same in all the cooperating program tasks. By using the id number the movements are not mixed up at the runtime.

Speed

Data type: speeddata

The speed data that applies to movements. Speed data defines the velocity for the tool center point, the tool reorientation, and external axes.

[\T]

Time

Data type: num

Continues on next page

1 Instructions

1.159 MoveLGO - Moves the robot linearly and sets group output signal in the corner

RobotWare Base

Continued

This argument is used to specify the total time in seconds during which the robot moves. It is substituted for the corresponding speed data. The speed data is computed under the assumption that the speed is constant during the movement. If the robot cannot keep this speed during the whole movement, for example, when the movement starts from a finepoint or ends in a finepoint, the actual movement time will be larger than the programmed time.

Zone

Data type: zonedata

Zone data for the movement. Zone data describes the size of the generated corner path.

Tool

Data type: tooldata

The tool in use when the robot moves. The tool center point is the point moved to the specified destination position.

[\WObj]

Work Object

Data type: wobjdata

The work object (coordinate system) to which the robot position in the instruction is related.

This argument can be omitted and if so then the position is related to the world coordinate system. If, on the other hand, a stationary TCP or coordinated external axes are used then this argument must be specified.

Signal

Data type: signalgo

The name of the group output signal to be changed.

[\Value]

Data type: num

The desired value of signal.

[\DValue]

Data type: dnum

The desired value of signal.

If none of the arguments \Value or \DValue is entered, an error message will be displayed.

[\TLoad]

Total load

Data type: loaddata

The \TLoad argument describes the total load used in the movement. The total load is the tool load together with the payload that the tool is carrying. If the \TLoad argument is used, then the loaddata in the current tooldata is not considered.

Continues on next page

1.159 MoveLGO - Moves the robot linearly and sets group output signal in the corner

RobotWare Base
Continued

If the `\TLoad` argument is set to `load0`, then the `\TLoad` argument is not considered and the `loaddata` in the current `tooldata` is used instead.

To be able to use the `\TLoad` argument it is necessary to set the value of the system parameter `ModalPayloadMode` to 0. If `ModalPayloadMode` is set to 0, it is no longer possible to use the instruction `GripLoad`.

The total load can be identified with the service routine `LoadIdentify`. If the system parameter `ModalPayloadMode` is set to 0, the operator has the possibility to copy the `loaddata` from the tool to an existing or new `loaddata` persistent variable when running the service routine.

It is possible to test run the program without any payload by using a digital input signal connected to the system input `SimMode` (Simulated Mode). If the digital input signal is set to 1, the `loaddata` in the optional argument `\TLoad` is not considered, and the `loaddata` in the current `tooldata` is used instead.



Note

The default functionality to handle payload is to use the instruction `GripLoad`. Therefore the default value of the system parameter `ModalPayloadMode` is 1.

Program execution

See the instruction `MoveL` for more information about linear movements.

The specified group output signal is set in the middle of the corner path for flying points, as shown in the figure below.

The figure shows set of group output signal in the corner path with `MoveLGO`.

```
MoveLGO p2, v1000, z30, tool2, go1 \Value:=5;
```

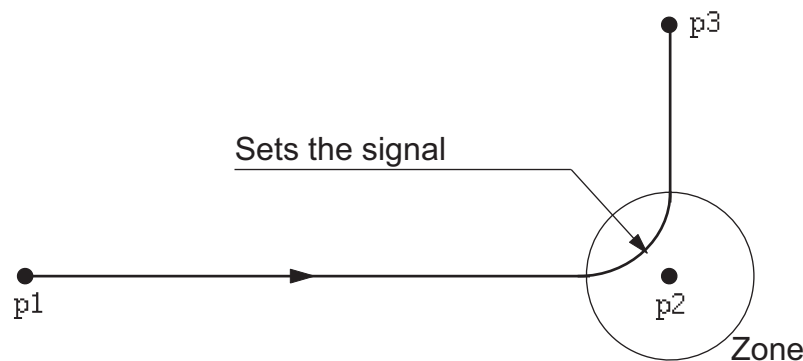

xx1400001118

For stop points we recommend the use of “normal” programming sequence with `MoveL + SetGO`. But when using stop point in instruction `MoveLGO`, the group output signal is set when the robot reaches the stop point.

The specified I/O signal is set in execution mode continuously and stepwise forward, but not in stepwise backward.

Continues on next page

1 Instructions

1.159 MoveLGO - Moves the robot linearly and sets group output signal in the corner

RobotWare Base

Continued

Error handling

The following recoverable errors are generated and can be handled in an error handler. The system variable `ERRNO` will be set to:

Name	Cause of error
<code>ERR_NO_ALIASIO_DEF</code>	The signal variable is a variable declared in RAPID. It has not been connected to an I/O signal defined in the I/O configuration with instruction <code>AliasIO</code> .
<code>ERR_NORUNUNIT</code>	There is no contact with the I/O device.
<code>ERR_SIG_NOT_VALID</code>	The I/O signal cannot be accessed. The reasons can be that the I/O device is not running or an error in the configuration (only valid for ICI field bus).

Limitations

`MoveLGO` cannot be executed in an UNDO handler or RAPID routine connected to any of the following special system events: `PowerOn`, `Stop`, `QStop`, `Restart`, `Reset` or `Step`.

Syntax

```
MoveLGO
[ ToPoint ':=' ] < expression (IN) of robtarget >
[ '\ ID ':=' < expression (IN) of identno > ] ','
[ Speed ':=' ] < expression (IN) of speeddata >
| [ '\ T ':=' < expression (IN) of num > ] ','
[ Zone ':=' ] < expression (IN) of zonedata > ','
[ Tool ':=' ] < persistent (PERS) of tooldata >
[ '\ WObj ':=' ] < persistent (PERS) of wobjdata > ','
[ Signal ':=' ] < variable (VAR) of signaldo > ','
[ '\ Value ':=' ] < expression (IN) of num > ]
| [ '\ Dvalue' :=' ] < expression (IN) of dnum >
[ '\ TLoad ':=' < persistent (PERS) of loaddata > ] ';'

```

Related information

For information about	See
Other positioning instructions	Technical reference manual - RAPID Overview
Moves the robot linearly	MoveL - Moves the robot linearly on page 458
Definition of load	loaddata - Load data on page 1682
Definition of velocity	speeddata - Speed data on page 1751
Definition of tools	tooldata - Tool data on page 1776
Definition of work objects	wobjdata - Work object data on page 1803
Definition of zone data	zonedata - Zone data on page 1811
Motion in general	Technical reference manual - RAPID Overview
Coordinate systems	Technical reference manual - RAPID Overview
Movements with I/O settings	Technical reference manual - RAPID Overview
Example of how to use <code>TLoad</code> , <code>Total Load</code> .	MoveL - Moves the robot linearly on page 458

Continues on next page

1.159 MoveLGO - Moves the robot linearly and sets group output signal in the corner

RobotWare Base

Continued

For information about	See
Defining the payload for a robot	GripLoad - Defines the payload for a robot on page 243
LoadIdentify, load identification service routine	<i>Operating manual - IRC5 with FlexPendant</i>
System input signal <i>SimMode</i> for running the robot in simulated mode without payload.	<i>Technical reference manual - System parameters</i>
System parameter <i>ModalPayload-Mode</i> for activating and deactivating payload.	<i>Technical reference manual - System parameters</i>

1 Instructions

1.160 MoveLSync - Moves the robot linearly and executes a RAPID procedure

RobotWare Base

1.160 MoveLSync - Moves the robot linearly and executes a RAPID procedure

Usage

`MoveLSync` (*Move Linearly Synchronously*) is used to move the tool center point (TCP) linearly to a given destination. The specified RAPID procedure is ordered to execute at the middle of the corner path in the destination point.

When the TCP is to remain stationary then this instruction can also be used to reorient the tool.

This instruction can only be used in the main task `T_ROB1` or, if in a *MultiMove* system, in Motion tasks.

Basic examples

The following examples illustrate the instruction `MoveLSync`:

Example 1

```
MoveLSync p1, v1000, z30, tool2, "proc1";
```

The TCP of the tool, `tool2`, is moved linearly to the position `p1` with speed data `v1000` and zone data `z30`. Procedure `proc1` is executed in the middle of the corner path at `p1`.

Example 2

```
MoveLSync p1, v1000, z30, tool2, "proc1";
```

The same as in example 1 above, but here the locally declared procedure `proc1` in module `MyModule` will be called in the middle of the corner path.

Arguments

```
MoveLSync ToPoint [\ID] Speed [\T] Zone Tool [\WObj] ProcName  
[\TLoad]
```

ToPoint

Data type: `robtarget`

The destination point of the robot and external axes. It is defined as a named position or stored directly in the instruction (marked with an * in the instruction).

[\ID]

Synchronization id

Data type: `identno`

The argument [\ID] is mandatory in *MultiMove* systems, if the movement is synchronized or coordinated synchronized. This argument is not allowed in any other case. The specified id number must be the same in all the cooperating program tasks. By using the id number the movements are not mixed up at the runtime.

Speed

Data type: `speeddata`

The speed data that applies to movements. Speed data defines the velocity of the TCP, the tool reorientation, and external axes.

Continues on next page

1.160 MoveLSync - Moves the robot linearly and executes a RAPID procedure *RobotWare Base* *Continued*

[\T]

Time

Data type: num

This argument is used to specify the total time in seconds during which the robot moves. It is substituted for the corresponding speed data. The speed data is computed under the assumption that the speed is constant during the movement. If the robot cannot keep this speed during the whole movement, for example, when the movement starts from a finepoint or ends in a finepoint, the actual movement time will be larger than the programmed time.

Zone

Data type: zonedata

Zone data for the movement. Zone data describes the size of the generated corner path.

Tool

Data type: tooldata

The tool in use when the robot moves. The tool center point is the point that is moved to the specified destination point.

[\Wobj]

Work Object

Data type: wobjdata

The work object (object coordinate system) to which the robot position in the instruction is related.

This argument can be omitted and if it is then the position is related to the world coordinate system. If, on the other hand, a stationary TCP or coordinated external axes are used this argument must be specified in order for a circle relative to the work object to be executed.

ProcName

Procedure Name

Data type: string

Name of the RAPID procedure to be executed at the middle of the corner path in the destination point.

The procedure will execute on trap level (see description of program execution).

ProcName

Procedure Name

Data type: string

Name of the RAPID procedure to be executed at the middle of the corner path in the destination point. The procedure call is a late binding call, and therefore inherits its properties.

The procedure will execute on trap level (see [Program execution on page 480](#)).

[\TLoad]

Total load

Continues on next page

1 Instructions

1.160 MoveLSync - Moves the robot linearly and executes a RAPID procedure

RobotWare Base

Continued

Data type: loaddata

The `\TLoad` argument describes the total load used in the movement. The total load is the tool load together with the payload that the tool is carrying. If the `\TLoad` argument is used, then the loaddata in the current tooldata is not considered.

If the `\TLoad` argument is set to `load0`, then the `\TLoad` argument is not considered and the loaddata in the current tooldata is used instead.

To be able to use the `\TLoad` argument it is necessary to set the value of the system parameter `ModalPayloadMode` to 0. If `ModalPayloadMode` is set to 0, it is no longer possible to use the instruction `GripLoad`.

The total load can be identified with the service routine `LoadIdentify`. If the system parameter `ModalPayloadMode` is set to 0, the operator has the possibility to copy the loaddata from the tool to an existing or new loaddata persistent variable when running the service routine.

It is possible to test run the program without any payload by using a digital input signal connected to the system input `SimMode` (Simulated Mode). If the digital input signal is set to 1, the loaddata in the optional argument `\TLoad` is not considered, and the loaddata in the current tooldata is used instead.



Note

The default functionality to handle payload is to use the instruction `GripLoad`. Therefore the default value of the system parameter `ModalPayloadMode` is 1.

Program execution

See the instruction `MoveL` for more information about linear movements.

The specified RAPID procedure is ordered to execute when the TCP reaches the middle of the corner path in the destination point of the `MoveLSync` instruction, as shown in the figure below.

The figure shows that the order to execute the user defined RAPID procedure is done in the middle of the corner path.

```
MoveLSync p2, v1000, z30, tool2, "my_proc";
```

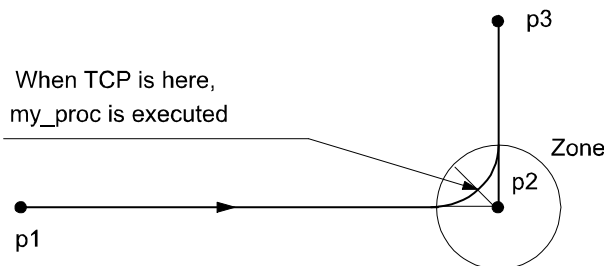

xx0500002194

For stop points we recommend the use of normal programming sequence with `MoveL` + other RAPID instructions in sequence.

Continues on next page

1.160 MoveLSync - Moves the robot linearly and executes a RAPID procedure

RobotWare Base
Continued

The table describes execution of the specified RAPID procedure in different execution modes:

Execution mode:	Execution of RAPID procedure:
Continuously or Cycle	According to this description
Forward step	In the stop point
Backward step	Not at all

MoveLSync is an encapsulation of the instructions TriggInt and TriggL. The procedure call is executed on trap level.

If the middle of the corner path in the destination point is reached during the deceleration after a program stop, the procedure will not be called (program execution is stopped). The procedure call will be executed at next program start.

Limitations

When the robot reaches the middle of the corner path there is normally a delay of 2-30 ms until the specified RAPID routine is executed, depending on what type of movement is being performed at the time.

Switching execution mode after program stop from continuously or cycle to stepwise forward or backward results in an error. This error tells the user that the mode switch can result in missed execution of the RAPID procedure in the queue for execution on the path.

Instruction MoveLSync cannot be used on trap level. The specified RAPID procedure cannot be tested with stepwise execution.

MoveLSync cannot be executed in an UNDO handler or RAPID routine connected to any of the following special system events: PowerOn, Stop, QStop, Restart, Reset or Step.

Syntax

```
MoveLSync
  [ ToPoint ':= ' ] < expression (IN) of robtarg >
  [ '\ ID ':= ' < expression (IN) of identno > ],'
  [ Speed ':= ' ] < expression (IN) of speeddata >
  | [ '\ T ':= ' < expression (IN) of num > ] ',
  [ Zone ':= ' ] < expression (IN) of zonedata > ',
  [ Tool ':= ' ] < persistent (PERS) of tooldata >
  [ '\ WObj ':= ' < persistent (PERS) of wobjdata > ] ',
  [ ProcName ':= ' ] < expression (IN) of string > ]
  [ '\ TLoad ':= ' < persistent (PERS) of loaddata > ] ';'

```

Related information

For information about	See
Other positioning instructions	Technical reference manual - RAPID Overview
Moves the robot linearly	MoveL - Moves the robot linearly on page 458
Definition of load	loaddata - Load data on page 1682
Definition of velocity	speeddata - Speed data on page 1751

Continues on next page

1 Instructions

1.160 MoveLSync - Moves the robot linearly and executes a RAPID procedure

RobotWare Base

Continued

For information about	See
Definition of tools	tooldata - Tool data on page 1776
Definition of work objects	wobjdata - Work object data on page 1803
Definition of zone data	zonedata - Zone data on page 1811
Motion in general	<i>Technical reference manual - RAPID Overview</i>
Coordinate systems	<i>Technical reference manual - RAPID Overview</i>
Defines a position related interrupt	TriggInt - Defines a position related interrupt on page 916
Linear robot movements with events	TriggL - Linear robot movements with events on page 935
Example of how to use <code>TLoad</code> , Total Load.	MoveL - Moves the robot linearly on page 458
Defining the payload for a robot	GripLoad - Defines the payload for a robot on page 243
LoadIdentify, load identification service routine	<i>Operating manual - IRC5 with FlexPendant</i>
System input signal <code>SimMode</code> for running the robot in simulated mode without payload.	<i>Technical reference manual - System parameters</i>
System parameter <code>ModalPayloadMode</code> for activating and deactivating payload.	<i>Technical reference manual - System parameters</i>

1.161 MovePnP - Moves the robot along a pick and place path

Usage

MovePnP is used to move the tool center point (TCP) quickly along a pick and place path as illustrated in the below picture.

The path includes two vertical movements connected by a top point. The height of the top point as well as the heights of the vertical movements are configurable to make the path assuming different shapes.

The different shape types are:

- Five points shape, as seen in the below picture.
- Four points shape, square like.
- Three points shape, arc like.
- Unsymmetrical, any of the above combinations.

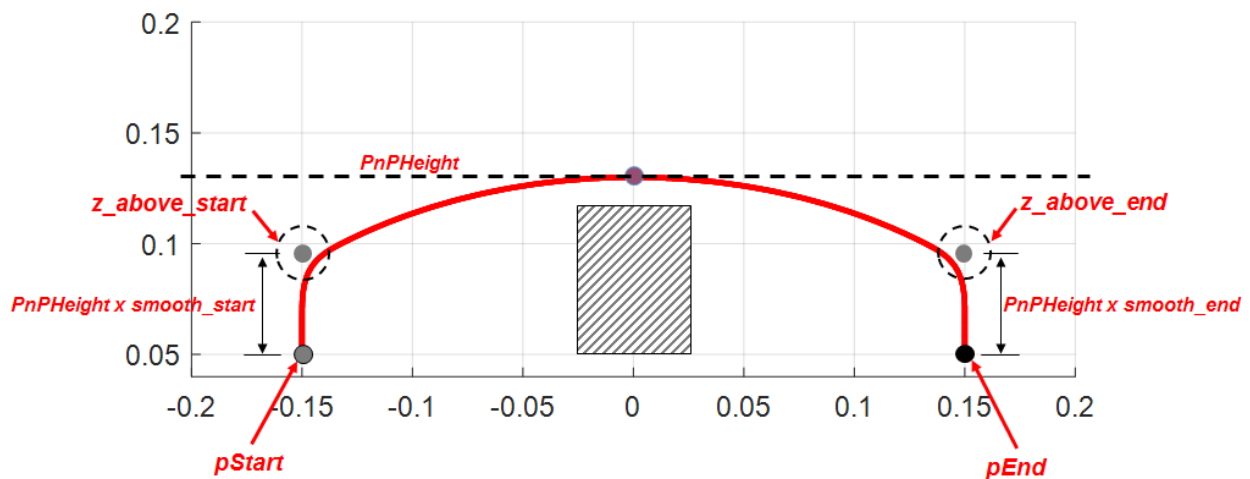

xx1700001194

Continues on next page

1 Instructions

1.161 MovePnP - Moves the robot along a pick and place path

SCARA robots

Continued

The path on the horizontal plane looks like an arc which curvature departs from a linear motion by an offset parameter that cannot be explicitly specified. This parameter is computed internally with the specific aim to minimize the cycle time.

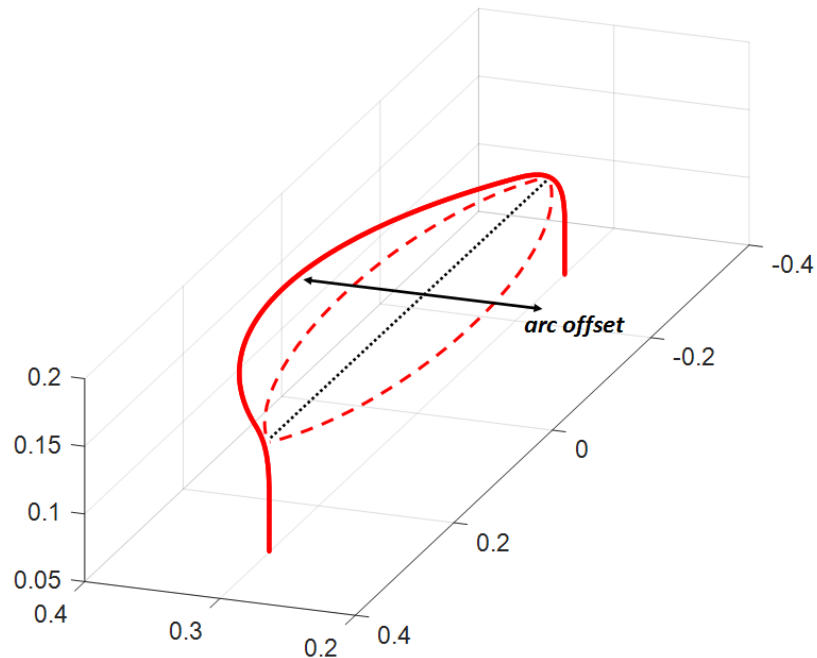

xx1800002597

Basic examples

The following example illustrates the instruction `MovePnP`.

See also [More examples on page 489](#).

Example 1

```
VAR num my_pnp_height := 130;
VAR pnpdata my_pnpdata

my_pnpdata.smooth_start := 50;
my_pnpdata.smooth_end := 50;
MoveL pStart, v300, fine, tool2;
MovePnP pEnd, v300, \PnPHeight:=my_pnp_height, fine, tool2
      \PnPDataIN:=my_pnpdata;
```

Continues on next page

1.161 MovePnP - Moves the robot along a pick and place path

SCARA robots

Continued

Five points shape path. It is configured by setting the optional parameters `smooth_start` and `smooth_end` to a value between 0 and 100.

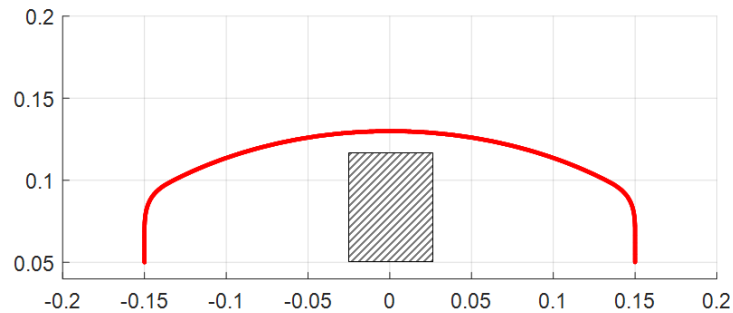

xx1700001195

Arguments

```
MovePnP ToPoint [\ID] Speed [\PnPHeight] Zone [\Inpos] Tool [\WObj]
[\TLoad] [\PnPDataIN] [\SignalIN] [\Value] [\MaxTime]
[\TimeFlag] [\PnPTrigg] [\PnPTriggOption]
```

ToPoint

Data type: `robtarget`

The destination point of the robot and external axes. It is defined as a named position or stored directly in the instruction (marked with an * in the instruction).

[\ID]

Synchronization id

Data type: `identno`

The argument `[\ID]` is mandatory in the MultiMove systems, if the movement is synchronized or coordinated synchronized. This argument is not allowed in any other case. The specified id number must be the same in all the cooperating program tasks. By using the id number the movements are not mixed up at the runtime.

Speed

Data type: `speeddata`

The speed data that applies to movements. Speed data defines the velocity of the tool center point, the tool reorientation, and additional axes. The speed data not used to generate the optimal path. The path executed using the `MovePnP` instruction is optimized for the maximum speed of the robot.

[\PnPHeight]

Data type: `num`

Continues on next page

1 Instructions

1.161 MovePnP - Moves the robot along a pick and place path

SCARA robots

Continued

The height of the top point specified in mm in absolute coordinates (not relative to the start point or to the end point) in the `ToPoint` reference frame. If the value is not specified, the height will correspond to the top (zero) position of axis 3.



Note

The way to use `PnPHeight` is evident in case of different pick and place heights (see [Example 4 on page 490](#)), since `PnPHeight` needs to be independent from both the start and the end height, that is, not specified relative to either on them.

Zone

Data type: `zonedata`

Zone data for the movement. Zone data describes the size of the generated corner path.

`[\Inpos]`

In position

Data type: `stoppointdata`

This argument is used to specify the convergence criteria for the position of the robot's TCP in the stop point. The stop point data substitutes the zone specified in the `Zone` parameter.

Tool

Data type: `tooldata`

The tool in use when the robot moves. The tool center point is the point moved to the specified destination point.

`[\Wobj]`

Work Object

Data type: `wobjdata`

The work object (coordinate system) to which the robot position in the instruction is related.

This argument can be omitted and if so then the position is related to the world coordinate system. If, on the other hand, a stationary TCP or coordinated external axes are used then this argument must be specified.

`[\TLoad]`

Total load

Data type: `loaddata`

The `\TLoad` argument describes the total load used in the movement. The total load is the tool load together with the payload that the tool is carrying. If the `\TLoad` argument is used, then the `loaddata` in the current `tooldata` is not considered.

If the `\TLoad` argument is set to `load0`, then the `\TLoad` argument is not considered and the `loaddata` in the current `tooldata` is used instead.

To be able to use the `\TLoad` argument it is necessary to set the value of the system parameter `ModalPayloadMode` to 0. If `ModalPayloadMode` is set to 0, it is no longer possible to use the instruction `GripLoad`.

Continues on next page

1.161 MovePnP - Moves the robot along a pick and place path

SCARA robots

Continued

The total load can be identified with the service routine LoadIdentify. If the system parameter ModalPayloadMode is set to 0, the operator has the possibility to copy the loaddata from the tool to an existing or new loaddata persistent variable when running the service routine.

It is possible to test run the program without any payload by using a digital input signal connected to the system input SimMode (Simulated Mode). If the digital input signal is set to 1, the loaddata in the optional argument \TLoad is not considered, and the loaddata in the current tooldata is used instead.

**Note**

The default functionality to handle payload is to use the instruction GripLoad. Therefore the default value of the system parameter ModalPayloadMode is 1.

[\PnPDataIN]

Data type: pnpdata

pnpdata is a data structure used to configure pick and place paths. If not specified, the path will be configured using the default values.

**Note**

If the structure is declared but not all the fields are assigned, the non-assigned fields will have default zero values.

[\SignalIN]

Data type: signaldi

The name of the signal.

[\Value]

Data type: dionum

The desired value of the signal.

[\MaxTime]

Data type: num

The maximum period of waiting time permitted, expressed in seconds. If this time runs out before the condition is met then the error handler will be called, if there is one, with the error code ERR_WAIT_MAXTIME. If there is no error handler then the execution will be stopped.

[\TimeFlag]

Data type: bool

The output parameter contains the value TRUE if the maximum permitted waiting time runs out before the condition is met. If this parameter is included in the instruction then it is not considered to be an error if the MaxTime runs out. This argument is ignored if the MaxTime argument is not included in the instruction.

[\PnPTrigg]

Data type: triggdata

Continues on next page

1 Instructions

1.161 MovePnP - Moves the robot along a pick and place path

SCARA robots

Continued

Variable that refers to trigger conditions and trigger activity defined earlier in the program using the instructions `TriggIO`, `TriggEquip`, `TriggInt`, `TriggCheckIO`, `TriggSpeed` or `TriggRampAO`.



Note

The triggering condition is set when the robot's TCP is at a point along the path according to the parameter `PnPTriggOption`.

`[\PnPTriggOption]`

Data type: num

Specifies which part of the movement is associated with the triggering conditions specified by `PnPTrigg`.

The valid options are:

Value	Description
1	The first vertical movement, from the start point.
2	The horizontal movement.
3	The second vertical movement, towards the end point.

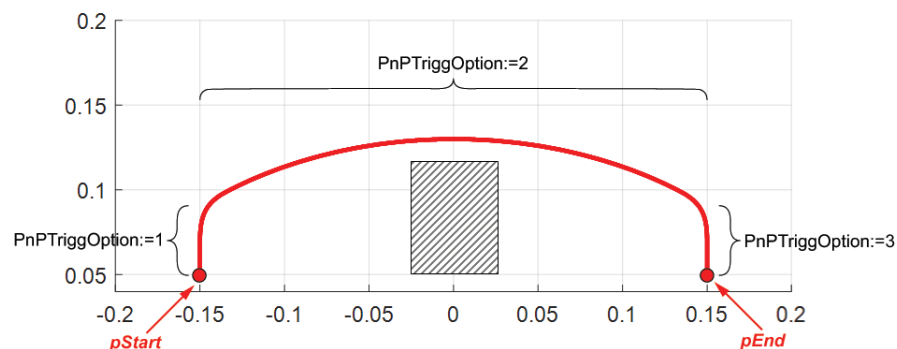

xx1800001532

Figure 1.1:

Default value is 2 (i.e. if `\PnPTriggOption` is omitted, the triggering will be specified along the horizontal movement).

Program execution

The robot TCP is moved to the destination position as follows:

- 1 The TCP moves vertically above the current robot position by a distance specified by a percentage of the path height.
- 2 The TCP reaches the top point computed as the middle point of the path with a path height specified by the `PnPHeight` parameter.
- 3 The TCP continues to move to a point above the end position described by a distance specified by a percentage of the path height.
- 4 The TCP moves vertically to the end position.

Continues on next page

1.161 MovePnP - Moves the robot along a pick and place path

SCARA robots

Continued

(The optional parameter `SignalIN` can be used to wait for a digital input signal before starting the motion to the end position).

- The optional argument `PnPTrigg` can be used to synchronize the movement with an external device while the TCP travels along the horizontal path or the vertical movement (depending on the optional argument `PnPTriggOption`).

More examples

More examples of the instruction `MovePnP` are illustrated below.

Example 1

```
VAR num my_pnp_height := 130;
VAR pnpdata my_pnpdata

my_pnpdata.smooth_start := 100;
my_pnpdata.smooth_end := 100;
MoveL pStart, v300, fine, tool2;
MovePnP pEnd, v300, \PnPHeight:=my_pnp_height, fine, tool2
      \PnPDataIN:=my_pnpdata;
```

Four points shape, square like. It is configured by setting the optional parameters `smooth_start` and `smooth_end` to 100.

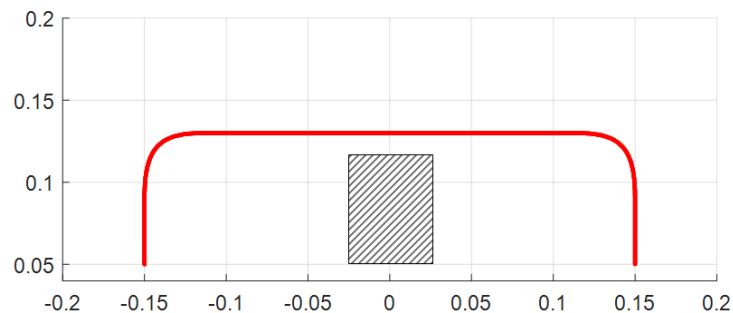

xx1700001196

Example 2

```
VAR num my_pnp_height := 130;
VAR pnpdata my_pnpdata

my_pnpdata.smooth_start := 0;
my_pnpdata.smooth_end := 0;
MoveL pStart, v300, fine, tool2;
MovePnP pEnd, v300, \PnPHeight:=my_pnp_height, fine, tool2
      \PnPDataIN:=my_pnpdata;
```

Continues on next page

1 Instructions

1.161 MovePnP - Moves the robot along a pick and place path

SCARA robots

Continued

Three points shape, arc like. It is configured by setting the optional parameters `smooth_start` and `smooth_end` to 0.

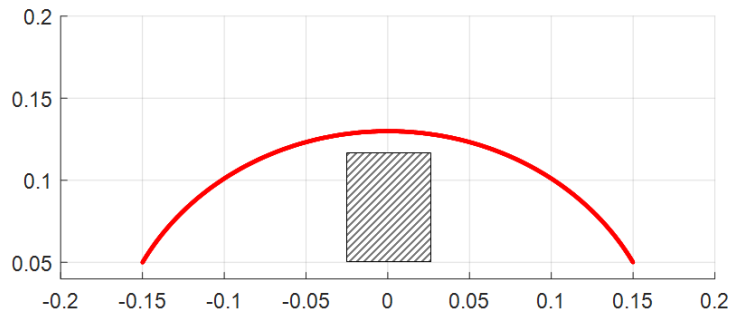

xx1700001197

Example 3

```
VAR num my_pnp_height := 130;
VAR pnpdata my_pnpdata

my_pnpdata.smooth_start := 100;
my_pnpdata.smooth_end := 50;
MoveL pStart, v300, fine, tool2;
MovePnP pEnd, v300, \PnPHeight:=my_pnp_height, fine, tool2
      \PnPDataIN:=my_pnpdata;
```

Four points unsymmetrical shape. It is configured by setting the optional parameters `smooth_start` and `smooth_end` to different values.

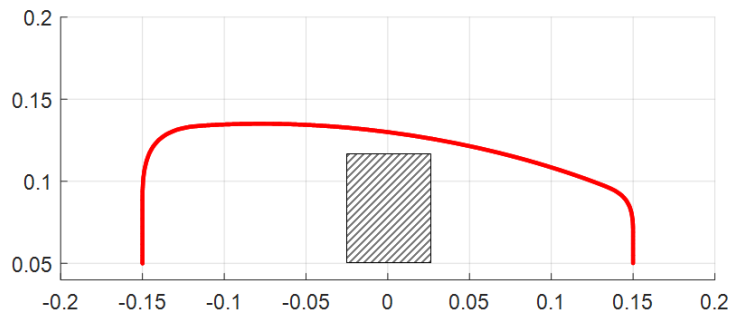

xx1800000951

Example 4

```
VAR num my_pnp_height := 130;
VAR pnpdata my_pnpdata

my_pnpdata.smooth_start := 100;
my_pnpdata.smooth_end := 100;
MoveL pStart, v300, fine, tool2;
MovePnP pEnd, v300, \PnPHeight:=my_pnp_height, fine, tool2
      \PnPDataIN:=my_pnpdata;
```

Continues on next page

1.161 MovePnP - Moves the robot along a pick and place path

SCARA robots

Continued

Four points shape with different pick and place levels. It is configured by setting the optional parameters `smooth_start` and `smooth_end` to 100 (no difference from pick and place on the same level).

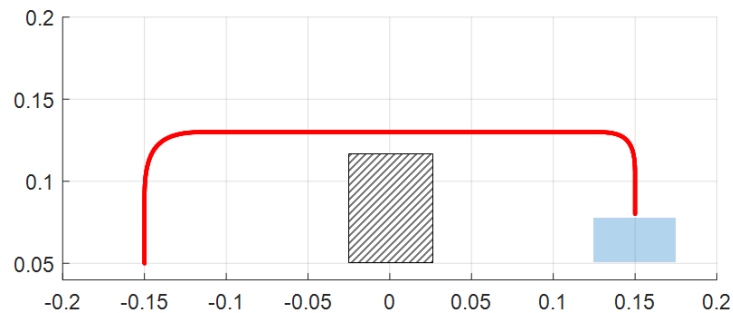

xx180000952

Example 5

```
VAR num my_pnp_height := 130;
VAR pnpdata my_pnpdata

my_pnpdata.smooth_start := 50;
my_pnpdata.smooth_end := 50;
MoveL pStart, v300, fine, tool2;
MovePnP pEnd, v300, \PnPHeight:=my_pnp_height, fine, tool2
\PnPDataIN:=my_pnpdata;
```

Five points shape with different pick and place levels. Note that the shape will be unsymmetrical even if the optional parameters `smooth_start` and `smooth_end` are set to the same value.

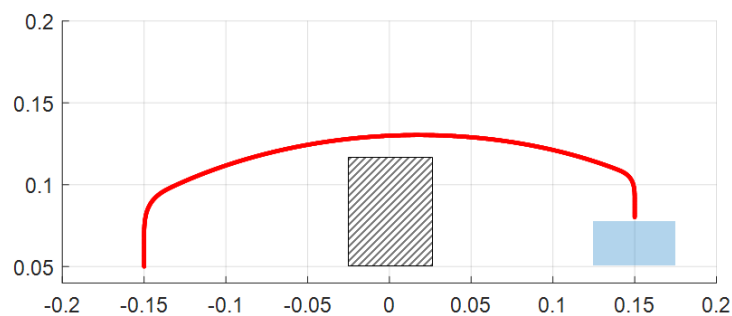

xx180000953

Example 6

```
VAR num my_pnp_height := 130;
VAR pnpdata my_pnpdata
VAR triggdata open_gripper;

my_pnpdata.smooth_start := 50;
my_pnpdata.smooth_end := 50;
TriggIO open_gripper, 25 \DOp:=doGripper, 0;
MoveL pStart, v300, fine, tool2;
```

Continues on next page

1 Instructions

1.161 MovePnP - Moves the robot along a pick and place path

SCARA robots

Continued

```
MovePnP pEnd, v300, \PnPHeight:=my_pnp_height, fine, tool2
  \PnPDataIN:=my_pnpdata \PnPTrigg:=open_gripper
  \PnPTriggOption:=3;
```

The digital output signal `doGripper` is set to the value 0 when the TCP is at a position where the vertical distance to `pEnd` is 25 mm.

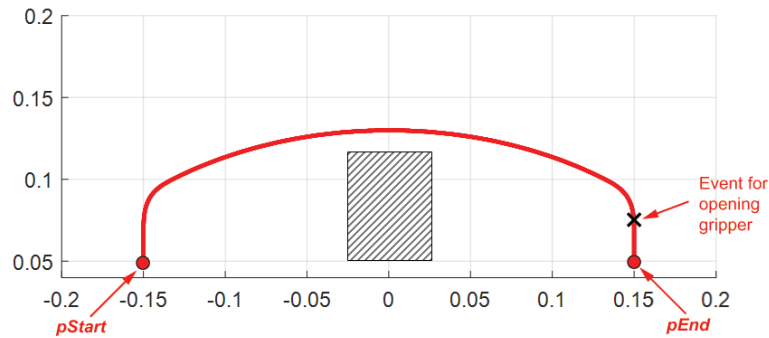

xx1800001531

Limitations

The instruction `MovePnP` does not support backwards execution.

The instruction `MovePnP` is only available for SCARA robots.

Syntax

```
MovePnP
  [ToPoint ':='] <expression (IN) of robtargt>
  ['\ ID ':='] <expression (IN) of identno>','
  [Speed ':='] <expression (IN) of speeddata>
  ['\ PnPHeight ':='] <expression (IN) of num>','
  [Zone ':='] <expression (IN) of zonedata>
  ['\ Inpos ':='] <expression (IN) of stoppointdata>','
  [Tool ':='] <persistent (PERS) of tooldata>
  ['\ WObj ':='] <persistent (PERS) of wobjdata>
  ['\ TLoad ':='] <persistent (PERS) of loaddata>
  ['\ PnPDataIN ':='] <expression (IN) of pnpdata>]
  ['\ SignalIN ':='] <variable (VAR) of signaldi>]
  ['\ Value ':='] <expression (IN) of dionum>]
  ['\ MaxTime ':='] <expression (IN) of num>]
  ['\ TimeFlag ':='] <variable (VAR) of bool>]
  ['\ PnPTrigg ':='] <variable (VAR) of triggdata>]
  ['\ PnPTriggOption ':='] <variable (VAR) of num>];'
```

Related information

For information about	See
Configuring pick and place paths	pnpdata - Configure pick and place paths on page 1713

1.162 MToolRotCalib - Calibration of rotation for moving tool

Usage

`MToolRotCalib` (*Moving Tool Rotation Calibration*) is used to calibrate the rotation of a moving tool.

The position of the robot and its movements are always related to its tool coordinate system, that is, the TCP and tool orientation. To get the best accuracy it is important to define the tool coordinate system as correctly as possible.

The calibration can also be done with a manual method using the FlexPendant, see *Operating manual - IRC5 with FlexPendant*.

Description

To define the tool orientation, you need a world fixed tip within the robot's working space.

Before using the instruction `MToolRotCalib` some preconditions must be fulfilled:

- The tool that is to be calibrated must be mounted on the robot and defined with correct component `robhold(TRUE)`.
- If using the robot with absolute accuracy then the load and center of gravity for the tool should already be defined. `LoadIdentify` can be used for the load definition.
- The TCP value of the tool must already be defined. The calibration can be done with the instruction `MToolTCPCalib`.
- `tool0`, `wobj0`, and `PDispOff` must be activated before jogging the robot.
- Jog the TCP of the actual tool as close as possible to the world fixed tip (origin of the tool coordinate system) and define a `jointtarget` for the reference point `RefTip`.
- Jog the robot without changing the tool orientation so the world fixed tip is pointing at some point on the positive z-axis of the tool coordinate system, and define a `jointtarget` for point `ZPos`.
- Optionally jog the robot without changing the tool orientation so the world fixed tip is pointing at some point on the positive x-axis of the tool coordinate system, and define a `jointtarget` for point `XPos`.

As a help for pointing out the positive z-axis and x-axis, some type of elongator tool can be used.

Continues on next page

1 Instructions

1.162 MToolRotCalib - Calibration of rotation for moving tool

RobotWare Base

Continued

See the figure below for a definition of jointtarget for RefTip, ZPos, and optional XPos.

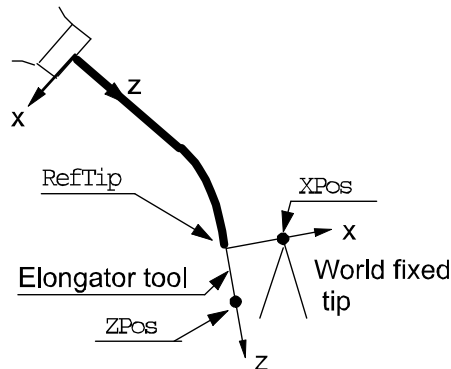

xx0500002192



Note

It is not recommended to modify the positions RefTip, ZPos, and XPos in the instruction MToolRotCalib.

Basic examples

The following examples illustrate the instruction MToolRotCalib:

Example 1

```
! Created with the world fixed tip pointing at origin, positive
! z-axis, and positive x-axis of the wanted tool coordinate
! system.
CONST jointtarget pos_tip := [...];
CONST jointtarget pos_z := [...];
CONST jointtarget pos_x := [...];

PERS tooldata tool1:= [ TRUE, [[20, 30, 100], [1, 0, 0 ,0]], [0.001,
    [0, 0, 0.001], [1, 0, 0, 0], 0, 0, 0]];

! Instructions for creating or ModPos of pos_tip, pos_z, and pos_x
MoveAbsJ pos_tip, v10, fine, tool0;
MoveAbsJ pos_z, v10, fine, tool0;
MoveAbsJ pos_x, v10, fine, tool0;

! Only tool calibration in the z direction
MToolRotCalib pos_tip, pos_z, tool1;
```

The tool orientation (tframe.rot) in the z direction of tool1 is calculated. The x and y directions of the tool orientation are calculated to coincide with the wrist coordinate system.

Example 2

```
! Calibration with complete tool orientation
MToolRotCalib pos_tip, pos_z \XPos:=pos_x, tool1;
```

Continues on next page

The complete tool orientation (`tframe.rot`) of `tool1` is calculated.

Arguments

```
MToolRotCalib RefTip ZPos [\XPos]Tool
```

RefTip

Data type: `jointtarget`

The point where the TCP of the tool is pointing at the world fixed tip.

ZPos

Data type: `jointtarget`

The elongator point that defines the positive z direction.

[\XPos]

Data type: `jointtarget`

The elongator point that defines the x positive direction. If this point is omitted then the x and y directions of the tool will coincide with the corresponding axes in the wrist coordinate system.

Tool

Data type: `tooldata`

The persistent variable of the tool that is to be calibrated.

Program execution

The system calculates and updates the tool orientation (`tframe.rot`) in the specified `tooldata`. The calculation is based on the specified 2 or 3 `jointtarget`. The remaining data in `tooldata` such as TCP (`tframe.trans`) is not changed.

Syntax

```
MToolRotCalib
  [RefTip ':='] <expression (IN) of jointtarget>','
  [ZPos ':='] <expression (IN) of jointtarget>
  ['\' XPos ':=' <expression (IN) of jointtarget>'],'
  [Tool ':='] <persistent (PERS) of tooldata>;'
```

Related information

For information about	See
Calibration of TCP for a moving tool	MToolTCPCalib - Calibration of TCP for moving tool on page 496
Calibration of TCP for a stationary tool	SToolTCPCalib - Calibration of TCP for stationary tool on page 812
Calibration of TCP and rotation for a stationary tool	SToolRotCalib - Calibration of TCP and rotation for stationary tool on page 809

1 Instructions

1.163 MToolTCPCalib - Calibration of TCP for moving tool RobotWare Base

1.163 MToolTCPCalib - Calibration of TCP for moving tool

Usage

MToolTCPCalib (*Moving Tool TCP Calibration*) is used to calibrate Tool Center Point - TCP for a moving tool.

The position of the robot and its movements are always related to its tool coordinate system, that is, the TCP and tool orientation. To get the best accuracy it is important to define the tool coordinate system as correctly as possible.

The calibration can also be done with a manual method using the FlexPendant, see *Operating manual - IRC5 with FlexPendant*.

Description

To define the TCP of a tool you need a world fixed tip within the robot's working space.

Before using the instruction MToolTCPCalib some preconditions must be fulfilled:

- The tool that is to be calibrated must be mounted on the robot and defined with correct component `robhold(TRUE)`.
- If using the robot with absolute accuracy then the load and center of gravity for the tool should already be defined. `LoadIdentify` can be used for the load definition.
- `tool0`, `wobj0`, and `PDispOff` must be activated before jogging the robot.
- Jog the TCP of the actual tool as close as possible to the world fixed tip (origin of the tool coordinate system) and define a `jointtarget` for the reference point `RefTip`.
- Define the further three positions (`p2`, `p3`, and `p4`) all with different orientations.

Definition of 4 jointtargets `p1`....`p4`, see figure below.

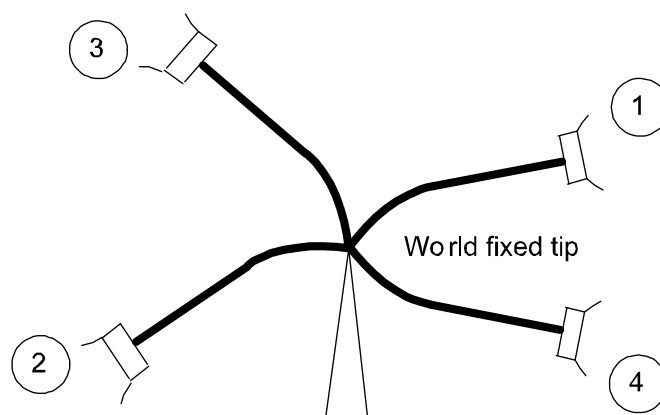

xx0500002191

Continues on next page

**Note**

It is not recommended to modify the positions `Pos1` to `Pos4` in the instruction `MToolTCPCalib`.

The reorientation between the 4 positions should be as big as possible, putting the robot in different configurations. Its also good practice to check the quality of the TCP after a calibration. Which can be performed by reorientation of the tool to check if the TCP is standing still.

Basic examples

The following example illustrates the instruction `MToolTCPCalib`:

Example 1

```
! Created with actual TCP pointing at the world fixed tip
CONST jointtarget p1 := [...];
CONST jointtarget p2 := [...];
CONST jointtarget p3 := [...];
CONST jointtarget p4 := [...];

PERS tooldata tool1:= [TRUE, [[0, 0, 0], [1, 0, 0, 0]], [0.001,
    [0, 0, 0.001], [1, 0, 0, 0], 0, 0, 0]];
VAR num max_err;
VAR num mean_err;
...
! Instructions for createing or ModPos of p1 - p4
MoveAbsJ p1, v10, fine, tool0;
MoveAbsJ p2, v10, fine, tool0;
MoveAbsJ p3, v10, fine, tool0;
MoveAbsJ p4, v10, fine, tool0;
...
MToolTCPCalib p1, p2, p3, p4, tool1, max_err, mean_err;
```

The TCP value (`tframe.trans`) of `tool1` will be calibrated and updated. `max_err` and `mean_err` will hold the max. error in mm from the calculated TCP and the mean error in mm from the calculated TCP, respectively.

Arguments

```
MToolTCPCalib Pos1 Pos2 Pos3 Pos4 Tool MaxErr MeanErr
```

`Pos1`

Data type: `jointtarget`

The first approach point.

`Pos2`

Data type: `jointtarget`

The second approach point.

`Pos3`

Data type: `jointtarget`

The third approach point.

Continues on next page

1 Instructions

1.163 MToolTCPCalib - Calibration of TCP for moving tool

RobotWare Base

Continued

Pos4

Data type: jointtarget

The fourth approach point.

Tool

Data type: tooldata

The persistent variable of the tool that is to be calibrated.

MaxErr

Data type: num

The maximum error in mm for one approach point.

MeanErr

Data type: num

The average distance that the approach points are from the calculated TCP, that is, how accurately the robot was positioned relative to the tip.

Program execution

The system calculates and updates the TCP value in the wrist coordinate system (`tframe.trans`) in the specified `tooldata`. The calculation is based on the specified 4 `jointtarget`. The remaining data in `tooldata`, such as tool orientation (`tframe.rot`), is not changed.

Syntax

```
MToolTCPCalib
  [Pos1 ':=' ] <expression (IN) of jointtarget>','
  [Pos2 ':=' ] <expression (IN) of jointtarget>','
  [Pos3 ':=' ] <expression (IN) of jointtarget>','
  [Pos4 ':=' ] <expression (IN) of jointtarget>','
  [Tool  ':=' ] <persistent (PERS) of tooldata>','
  [MaxErr ':=' ] <variable (VAR) of num>','
  [MeanErr ':=' ] <variable (VAR) of num>';'
```

Related information

For information about	See
Calibration of rotation for a moving tool	MToolRotCalib - Calibration of rotation for moving tool on page 493
Calibration of TCP for a stationary tool	SToolTCPCalib - Calibration of TCP for stationary tool on page 812
Calibration of TCP and rotation for a stationary tool	SToolRotCalib - Calibration of TCP and rotation for stationary tool on page 809

1.164 Open - Opens a file or I/O device

Usage

`Open` is used to open a file or I/O device for reading or writing.

Basic examples

The following examples illustrate the instruction `Open`:

See also [More examples on page 501](#).

Example 1

```
VAR iodev logfile;
...
Open "HOME:" \File:= "LOGFILE1.DOC", logfile \Write;
```

The file LOGFILE1.DOC in unit HOME: is opened for writing. The reference name logfile is used later in the program when writing to the file.

Example 2

```
VAR iodev logfile;
...
Open "LOGFILE1.DOC", logfile \Write;
```

Same result as example 1. The default directory is HOME:.

Arguments

`Open Object [\File] IODevice [\Read] | [\Write] | [\Append] [\Bin]`

Object

Data type: string

The I/O object (I/O device) that is to be opened, e.g. "HOME:", "TEMP:", "com1:" or "pc:" (option).

The table describes different I/O devices on the robot controller.

I/O device name	Type of I/O device
"HOME:" or diskhome ⁱ	SD-card
"TEMP:" or disktemp ⁱ	SD-card
"RemovableDisk1:" or usbdisk1 ⁱ "RemovableDisk2:" or usbdisk2 ⁱ "RemovableDisk3:" or usbdisk3 ⁱ	e.g. USB memory stick
"com1:" ⁱⁱ	Serial channel
"pc:" ⁱⁱⁱ	Mounted disk
"RAMDISK:" or diskram ^{i, iv}	RAM disk memory

ⁱ RAPID string defining a device name.

ⁱⁱ User defined serial channel name defined in the system parameters.

ⁱⁱⁱ Application protocol, server path defined in the system parameters.

^{iv} The RAM disk memory is not for permanent storage of any data. The size is around 100 Mb and it is cleared at each shut down.

Continues on next page

1 Instructions

1.164 Open - Opens a file or I/O device

RobotWare Base

Continued

The following table describes different I/O devices on the virtual controller.

I/O device name	Type of I/O device
"HOME:" or diskhome ⁱ	
"TEMP:" or disktemp	Hard Drive
"RemovableDisk1:" or usbdisk1 "RemovableDisk2:" or usbdisk2 "RemovableDisk3:" or usbdisk3	e.g. USB memory stick
"RAMDISK:" or diskram ⁱ	Hard Drive ..\TEMP (points to the TEMP folder which is located in the same folder as your virtual system)

ⁱ RAPID string defining a device name.

[\File]

Data type: string

The name of the file to be opened, e.g. "LOGFILE1.DOC" or "LOGDIR/LOGFILE1.DOC"

The complete path can also be specified in the argument `Object`, "HOME:/LOGDIR/LOGFILE.DOC" .

IIODevice

Data type: iodev

A reference to the file or I/O device to open. This reference is then used for reading from and writing to the file or I/O device.

[\Read]

Data type: switch

Opens a file or I/O device for reading. When reading from a file the reading is started from the beginning of the file.

[\Write]

Data type: switch

Opens a file or I/O device for writing. If the selected file already exists then its contents are deleted. Anything subsequently written is written at the start of the file.

[\Append]

Data type: switch

Opens a file or I/O device for writing. If the selected file already exists then anything subsequently written is written at the end of the file.

Open a file or I/O device with `\Append` and without the `\Bin` arguments. The instruction opens a character-based file or I/O device for writing.

Open a file or I/O device with `\Append` and `\Bin` arguments. The instruction opens a binary file or I/O device for both reading and writing. The arguments `\Read`, `\Write`, `\Append` are mutually exclusive. If none of these are specified then the instruction acts in the same way as the `\Write` argument for character-based files

Continues on next page

or a I/O device (instruction without `\Bin` argument) and in the same way as the `\Append` argument for binary files or a I/O device (instruction with `\Bin` argument).

[`\Bin`]

Data type: `switch`

The file or I/O device is opened in a binary mode. If none of the arguments `\Read`, `\Write` or `\Append` are specified then the instruction opens a binary file or I/O device for both reading and writing, with the file pointer at the end of the file.

The `Rewind` instruction can be used to set the file pointer to the beginning of the file if desirable.

The set of instructions to access a binary file or I/O device is different from the set of instructions to access a character-based file.

More examples

More examples of how to use the instruction `Open` are illustrated below.

Example 1

```

]
VAR iODEV printer;
...
Open "com1:", printer \Bin;
WriteStrBin printer, "This is a message to the printer\0D";
Close printer;

```

The serial channel `com1:` is opened for binary reading and writing. The reference name `printer` is used later when writing to and closing the serial channel.

Example 2

```

VAR iODEV io_device;
VAR rawbytes raw_data_out;
VAR rawbytes raw_data_in;
VAR num float := 0.2;
VAR string answer;

ClearRawBytes raw_data_out;
PackDNHeader "10", "20 1D 24 01 30 64", raw_data_out;
PackRawBytes float, raw_data_out, (RawBytesLen(raw_data_out)+1)
    \Float4;

Open "/FCI1:/dsqc328_1", io_device \Bin;
WriteRawBytes io_device, raw_data_out;
ReadRawBytes io_device, raw_data_in \Time:=1;
Close io_device;

UnpackRawBytes raw_data_in, 1, answer \ISOLatin1Encoding:=10;

```

In this example `raw_data_out` is cleared and then packed with DeviceNet header and a float with value 0.2.

A device, `"/FCI1:/dsqc328_1"`, is opened and the current valid data in `raw_data_out` is written to the device. Then the program waits for at most 1 second to read from the device, which is stored in the `raw_data_in`.

Continues on next page

1 Instructions

1.164 Open - Opens a file or I/O device

RobotWare Base

Continued

After having closed the device “/FCI1/:dsqc328_1”, then the read data is unpacked as a string of 10 characters and stored in the string named `answer`.

Program execution

The specified file or I/O device is opened so that it is possible to read from or write to it.

It is possible to open the same physical file several times at the same time but each invocation of the `Open` instruction will return a different reference to the file (data type `iodev`). For example, it is possible to have one write pointer and one different read pointer to the same file at the same time.

The `iodev` variable used when opening a file or I/O device must be free from use. If it has been used previously to open a file then this file must be closed before issuing a new `Open` instruction with the same `iodev` variable.

At Program Stop and moved PP to Main, any open file or I/O device in the program task will be closed and the I/O descriptor in the variable of type `iodev` will be reset. An exception to the rule is variables that are installed shared in the system of type `global VAR` or `LOCAL VAR`. Such file or I/O device belonging to the whole system will still be open.

At power fail restart, any open file or I/O device in the system will be closed and the I/O descriptor in the variable of type `iodev` will be reset.

Error handling

The following recoverable errors are generated and can be handled in an error handler. The system variable `ERRNO` will be set to:

Name	Cause of error
<code>ERR_FILEOPEN</code>	A file cannot be opened.

Syntax

```
Open
  [ Object '[:]=' <expression (IN) of string>
  [ '\ File '[:]=' <expression (IN) of string> ] ', '
  [ IODevice '[:]=' <variable (VAR) of iodev>
  [ '\ Read ] |
  [ '\ Write ] |
  [ '\ Append ]
  [ '\ Bin ] ';' ;
```

Related information

For information about	See
Writing to, reading from and closing files or I/O devices	<i>Technical reference manual - RAPID Overview</i>
Fieldbus Command Interface File and I/O device handling	<i>Application manual - Controller software IRC5</i>

1.165 OpenDir - Open a directory

Usage

OpenDir is used to open a directory for further investigation.

Basic examples

The following example illustrates the instruction OpenDir:

Example 1

```

PROC lmdir(string dirname)
  VAR dir directory;
  VAR string filename;
  OpenDir directory, dirname;
  WHILE ReadDir(directory, filename) DO
    TPWrite filename;
  ENDWHILE
  CloseDir directory;
ENDPROC

```

This example prints out the names of all files or subdirectories under the specified directory.

Arguments

OpenDir Dev Path

Dev

Data type: dir

A variable with reference to the directory, fetched by OpenDir. This variable is then used for reading from the directory.

Path

Data type: string

Path to the directory.

Error handling

The following recoverable errors are generated and can be handled in an error handler. The system variable ERRNO will be set to:

Name	Cause of error
ERR_FILEACC	The path points to a non-existing directory or there are too many directories open at the same time.

Limitations

Open directories should always be closed by the user after reading (instruction CloseDir).

Syntax

```

OpenDir
  [ Dev ':' ] < variable (VAR) of dir> ','
  [ Path ':' ] < expression (IN) of string> ';'

```

Continues on next page

1 Instructions

1.165 OpenDir - Open a directory

RobotWare Base

Continued

Related information

For information about	See
Directory	dir - File directory structure on page 1648
Make a directory	MakeDir - Create a new directory on page 353
Remove a directory	RemoveDir - Delete a directory on page 602
Read a directory	ReadDir - Read next entry in a directory on page 1426
Close a directory	CloseDir - Close a directory on page 152
Remove a file	RemoveFile - Delete a file on page 604
Rename a file	RenameFile - Rename a file on page 607
File and I/O device handling	Application manual - Controller software IRC5

1.166 PackDNHeader - Pack DeviceNet Header into rawbytes data

Usage

`PackDNHeader` is used to pack the header of a DeviceNet explicit message into a container of type `rawbytes`.

The data part of the DeviceNet message can afterwards be set with the instruction `PackRawBytes`.

Basic examples

The following examples illustrate the instruction `PackDNHeader`:

Example 1

```
VAR rawbytes raw_data;
```

```
PackDNHeader "0E", "6,20 01 24 01 30 06,9,4", raw_data;
```

Pack the header for DeviceNet explicit message with service code "0E" and path string "6,2001 24 01 30 06,9,4" into `raw_data` corresponding to get the serial number from some I/O device.

This message is ready to send without filling the message with additional data.

Example 2

```
VAR rawbytes raw_data;
```

```
PackDNHeader "10", "20 1D 24 01 30 64", raw_data;
```

Pack the header for DeviceNet explicit message with service code "10" and path string "201D 24 01 30 64" into `raw_data` corresponding to set the filter time for the rising edge on insignal 1 for some I/O device.

This message must be increased with data for the filter time. This can be done with instruction `PackRawBytes` starting at index `RawBytesLen(raw_data)+1` (done after `PackDNHeader`).

Arguments

```
PackDNHeader Service Path RawData
```

Service

Data type: `string`

The service to be done such as get or set attribute. To be specified with a hexadecimal code in a string e.g. "IF".

String length	2 characters
Format	'0' - '9', 'a' - 'f', 'A' - 'F'
Range	"00" - "FF"

The values for the `Service` is found in the EDS file. For more descriptions, see the Open DeviceNet Vendor Association *ODVA DeviceNet Specification revision 2.0*.

Path

Data type: `string`

Continues on next page

1 Instructions

1.166 PackDNHeader - Pack DeviceNet Header into rawbytes data

RobotWare Base

Continued

The values for the `Path` is found in the EDS file. For more descriptions, see the Open DeviceNet Vendor Association *ODVA DeviceNet Specification revision 2.0*. Support for both long string format (e.g. "6,20 1D 24 01 30 64,8,1") and short string format (e.g. "20 1D 24 01 30 64").

RawData

Data type: `rawbytes`

Variable container to be packed with message header data starting at index 1 in `RawData`.

Program execution

During program execution the DeviceNet message `RawData` container is:

- first completely cleared
- and then the header part is packed with data

Format DeviceNet Header

The instruction `PackDNHeader` will create a DeviceNet message header with following format:

RawData Header-Format	No of bytes	Note
Format	1	Internal robot controller code for DeviceNet
Service	1	Hex code for service
Size of Path	1	In bytes
Path	x	ASCII chars

The data part of the DeviceNet message can afterwards be set with the instruction `PackRawBytes` starting at index fetched with `(RawBytesLen(my_rawdata)+1)`.

Syntax

```
PackDNHeader
  [Service ':='] <expression (IN) of string>', '
  [Path ':='] <expression (IN) of string>', '
  [RawData ':='] <variable (VAR) of rawbytes>';
```

Related information

For information about	See
<code>rawbytes</code> data	rawbytes - Raw data on page 1721
Get the length of <code>rawbytes</code> data	RawBytesLen - Get the length of rawbytes data on page 1422
Clear the contents of <code>rawbytes</code> data	ClearRawBytes - Clear the contents of rawbytes data on page 145
Copy the contents of <code>rawbytes</code> data	CopyRawBytes - Copy the contents of rawbytes data on page 169
Pack data to <code>rawbytes</code> data	PackRawBytes - Pack data into rawbytes data on page 508
Write <code>rawbytes</code> data	WriteRawBytes - Write rawbytes data on page 1108

Continues on next page

1.166 PackDNHeader - Pack DeviceNet Header into rawbytes data

RobotWare Base

Continued

For information about	See
Read rawbytes data	ReadRawBytes - Read rawbytes data on page 593
Unpack data from rawbytes data	UnpackRawBytes - Unpack data from rawbytes data on page 1013
Bit/Byte Functions	<i>Technical reference manual - RAPID Overview</i>
String functions	<i>Technical reference manual - RAPID Overview</i>
File and I/O device handling	<i>Application manual - Controller software IRC5</i>

1 Instructions

1.167 PackRawBytes - Pack data into rawbytes data

RobotWare Base

1.167 PackRawBytes - Pack data into rawbytes data

Usage

PackRawBytes is used to pack the contents of variables of type `num`, `dnum`, `byte`, or `string` into a container of type `rawbytes`.

Basic examples

The following examples illustrate the instruction `PackRawBytes`.

```
VAR rawbytes raw_data;  
VAR num integer := 8;  
VAR dnum bigInt := 4294967295;  
VAR num float := 13.4;  
VAR byte data1 := 122;  
VAR byte byte1;  
VAR string string1:="abcdefg";  
PackDNHeader "10", "20 1D 24 01 30 64", raw_data;
```

Pack the header for DeviceNet into `raw_data`.

Then pack requested fieldbus data in `raw_data` with `PackRawBytes`. The examples below show how different data can be added.

Example 1

```
PackRawBytes integer, raw_data, (RawBytesLen(raw_data)+1) \IntX :=  
DINT;
```

The contents of the next 4 bytes after the header in `raw_data` will be 8 decimal.

Example 2

```
PackRawBytes bigInt, raw_data, (RawBytesLen(raw_data)+1) \IntX :=  
UDINT;
```

The contents of the next 4 bytes after the header in `raw_data` will be 4294967295 decimal.

Example 3

```
PackRawBytes bigInt, raw_data, (RawBytesLen(raw_data)+1) \IntX :=  
LINT;
```

The contents of the next 8 bytes after the header in `raw_data` will be 4294967295 decimal.

Example 4

```
PackRawBytes float, raw_data, RawBytesLen(raw_data)+1) \Float4;
```

The contents of the next 4 bytes in `raw_data` will be 13.4 decimal.

Example 5

```
PackRawBytes data1, raw_data, (RawBytesLen(raw_data)+1) \ASCII;
```

The contents of the next byte in `raw_data` will be 122, the ASCII code for "z".

Example 6

```
PackRawBytes string1, raw_data, (RawBytesLen(raw_data)+1) \ASCII;
```

The contents of next 7 bytes in `raw_data` will be "abcdefg", coded in ASCII.

Example 7

```
byte1 := StrToByte("1F" \Hex);
```

Continues on next page

1.167 PackRawBytes - Pack data into rawbytes data

RobotWare Base

Continued

```
PackRawBytes byte1, raw_data, (RawBytesLen(raw_data)+1) \Hex1;
```

The contents of the next byte in `raw_data` will be "1F", hexadecimal.

Arguments

```
PackRawBytes Value RawData [ \Network ] StartIndex [ \Hex1 ] | [ \IntX ] | [ \Float4 ] | [ \ASCII ]
```

See [Combining the arguments on page 510](#).

Value

Data type: anytype

Data to be packed into `RawData`.

Allowed data types are: num, dnum, byte, or string. Array cannot be used.

RawData

Data type: rawbytes

Variable container to be packed with data.

[\Network]

Data type: switch

Indicates that integer and float shall be packed in big-endian (network order) representation in `RawData`. ProfiBus and InterBus use big-endian.

Without this switch, integer and float will be packed in little-endian (not network order) representation in `RawData`. DeviceNet uses little-endian.

Only relevant together with optional parameter `\IntX` - UINT, UDINT, ULINT, INT, DINT, LINT, and `\Float4`.

StartIndex

Data type: num

`StartIndex` between 1 and 1024 indicates where the first byte contained in `Value` shall be placed in `RawData`.

[\Hex1]

Data type: switch

The `Value` to be packed has byte format and shall be converted to hexadecimal format and stored in 1 byte in `RawData`.

[\IntX]

Data type: inttypes

The `Value` to be packed has num or dnum format. It is an integer and shall be stored in `RawData` according to this specified constant of data type `inttypes`.

See [Predefined data on page 510](#).

[\Float4]

Data type: switch

The `Value` to be packed has num format and shall be stored as float, 4 bytes, in `RawData`.

Continues on next page

1 Instructions

1.167 PackRawBytes - Pack data into rawbytes data

RobotWare Base

Continued

[\ASCII]

Data type: switch

The Value to be packed has byte or string format.

If the Value to be packed has byte format then it will be stored in RawData as 1 byte interpreting Value as ASCII code for a character.

If the Value to be packed has string format (1-80 characters) then it will be stored in RawData as ASCII characters with the same number of characters as contained in Value. String data is not NULL terminated by the system in data of type rawbytes. It is up to the programmer to add string header if necessary (required for DeviceNet).

Combining the arguments

One of the arguments \Hex1, \IntX, \Float4, or \ASCII must be used.

The following combinations are allowed:

Data type of value:	Allowed optional parameters:
num ⁱ	\IntX
dnum ⁱⁱ	\IntX
num	\Float4
string	\ASCII (1-80 characters)
byte	\Hex1 \ASCII

ⁱ Must be an integer within the value range of selected symbolic constant USINT, UINT, UDINT, SINT, INT or DINT.

ⁱⁱ Must be an integer within the value range of selected symbolic constant USINT, UINT, UDINT, ULINT, SINT, INT, DINT or LINT.

Program execution

During program execution the data is packed from the variable of type anytype into a container of type rawbytes.

The current length of valid bytes in the RawData variable is set to:

- (startIndex + packed_number_of_bytes - 1)
- The current length of valid bytes in the RawData variable is not changed if the complete pack operation is done inside the old current length of valid bytes in the RawData variable.

Predefined data

The following symbolic constants of the data type inttypes are predefined and can be used to specify the integer in parameter \IntX.

Symbolic constant	Constant value	Integer format	Integer value range
USINT	1	Unsigned 1 byte integer	0 ... 255
UINT	2	Unsigned 2 byte integer	0 ... 65 535
UDINT	4	Unsigned 4 byte integer	0 ... 8 388 608 ⁱ 0 ... 4 294 967 295 ⁱⁱ
ULINT	8	Unsigned 8 byte integer	0 ... 4 503 599 627 370 496 ⁱⁱⁱ

Continues on next page

Symbolic constant	Constant value	Integer format	Integer value range
SINT	- 1	Signed 1 byte integer	- 128... 127
INT	- 2	Signed 2 byte integer	- 32 768 ... 32 767
DINT	- 4	Signed 4 byte integer	- 8 388 607 ... 8 388 608 ⁱ -2 147 483 648 ... 2 147 483 647 ^{iv}
LINT	- 8	Signed 8 byte integer	- 4 503 599 627 370 496... 4 503 599 627 370 496 ⁱⁱⁱ

- ⁱ Limitation in RAPID for storage of integer in data type `num`.
ⁱⁱ Range when using a `dnum` variable and `inttype UDINT`.
ⁱⁱⁱ Limitation in RAPID for storage of integer in data type `dnum`.
^{iv} Range when using a `dnum` variable and `inttype DINT`.

Syntax

```
PackRawBytes
  [Value ':=' ] <expression (IN) of anytype>','
  [RawData ':=' ] <variable (VAR) of rawbytes>
  ['\ ' Network] ','
  [StartIndex ':=' ] <expression (IN) of num>
  ['\ ' Hex1]
  |['\ ' IntX ':=' <expression (IN) of inttypes>]
  |['\ ' Float4]
  |['\ ' ASCII] ';'

```

Related information

For information about	See
rawbytes data	rawbytes - Raw data on page 1721
Get the length of rawbytes data	RawBytesLen - Get the length of rawbytes data on page 1422
Clear the contents of rawbytes data	ClearRawBytes - Clear the contents of rawbytes data on page 145
Copy the contents of rawbytes data	CopyRawBytes - Copy the contents of rawbytes data on page 169
Pack DeviceNet header into rawbytes data	PackDNHeader - Pack DeviceNet Header into rawbytes data on page 505
Write rawbytes data	WriteRawBytes - Write rawbytes data on page 1108
Read rawbytes data	ReadRawBytes - Read rawbytes data on page 593
Unpack data from rawbytes data	UnpackRawBytes - Unpack data from rawbytes data on page 1013
Bit/Byte Functions	Technical reference manual - RAPID Overview
String functions	Technical reference manual - RAPID Overview
File and I/O device handling	Application manual - Controller software IRC5

1 Instructions

1.168 PathAccLim - Reduce TCP acceleration along the path *RobotWare Base*

1.168 PathAccLim - Reduce TCP acceleration along the path

Usage

`PathAccLim` (*Path Acceleration Limitation*) is used to set or reset limitations on TCP acceleration and/or TCP deceleration along the movement path.

The limitation will be performed along the movement path, that is, the acceleration in the path frame. It is the tangential acceleration/deceleration in the path direction that will be limited.

The instruction does not limit the total acceleration of the equipment, that is, the acceleration in world frame, so it cannot be directly used to protect the equipment from large accelerations.

This instruction can only be used in the main task `T_ROB1` or, if in a *MultiMove* system, in Motion tasks.

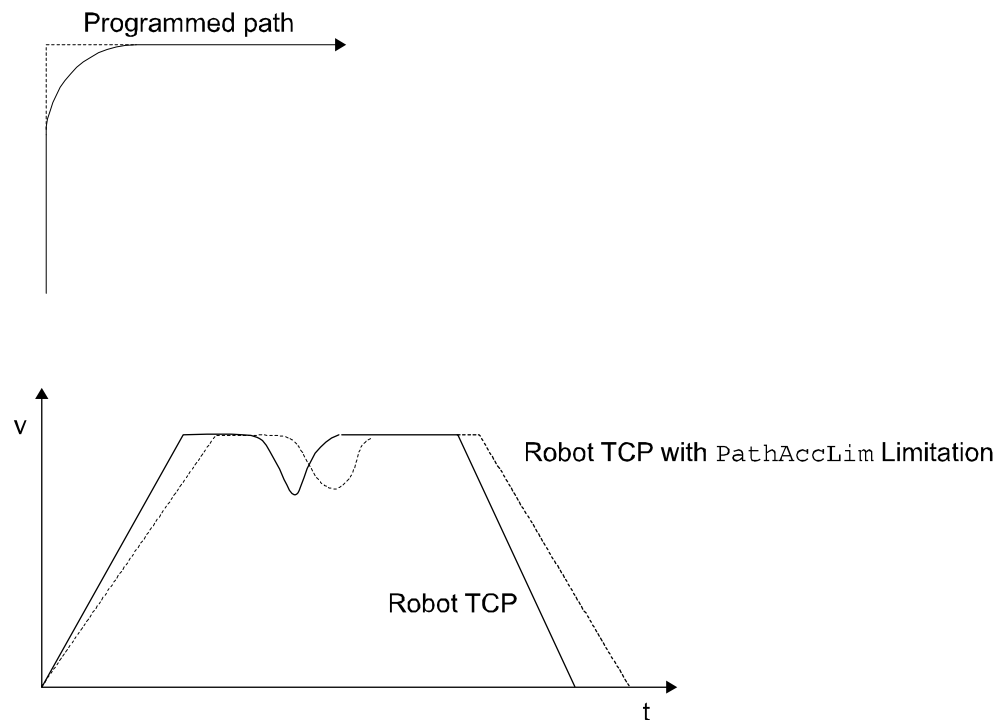

Basic examples

The following examples illustrate the instruction `PathAccLim`:

See also [More examples on page 514](#).

Example 1

```
PathAccLim TRUE \AccMax := 4, TRUE \DecelMax := 4;
```

TCP acceleration and TCP deceleration are limited to 4 m/s^2 .

Example 2

```
PathAccLim FALSE, FALSE;
```

The TCP acceleration and deceleration is reset to maximum (default).

Continues on next page

Arguments

PathAccLim AccLim [`\AccMax`] DecelLim [`\DecelMax`]

AccLim

Data type: bool

TRUE if there is to be a limitation of the acceleration, FALSE otherwise.

[`\AccMax`]

Data type: num

The absolute value of the acceleration limitation in m/s^2 . Only to be used when AccLim is TRUE.

DecelLim

Data type: bool

TRUE if there is to be a limitation of the deceleration, FALSE otherwise.

[`\DecelMax`]

Data type: num

The absolute value of the deceleration limitation in m/s^2 . Only to be used when DecelLim is TRUE.

Program execution

The acceleration/deceleration limitations applies for the next executed movement instruction until a new PathAccLim instruction is executed.

The maximum acceleration/deceleration (PathAccLim FALSE, FALSE) are automatically set

- when using the restart mode **Reset RAPID**
- when loading a new program or a new module
- when starting program execution from the beginning
- when moving the program pointer to `main`
- when moving the program pointer to a routine
- when moving the program pointer in such a way that the execution order is lost.

If there is a combination of instructions AccSet and PathAccLim the system reduces the acceleration/deceleration in the following order:

- according AccSet
- according PathAccLim

Continues on next page

1 Instructions

1.168 PathAccLim - Reduce TCP acceleration along the path

RobotWare Base

Continued

More examples

More examples of how to use the instruction `PathAccLim` are illustrated below.

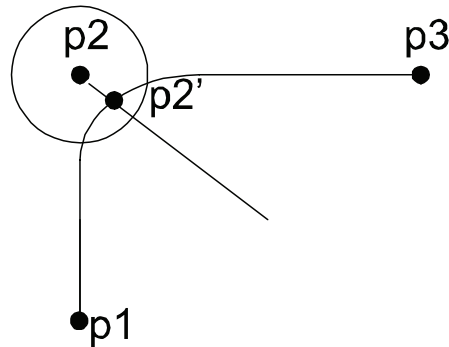

Example 1

```
MoveL p1, v1000, fine, tool0;  
PathAccLim TRUE\AccMax := 4, FALSE;  
MoveL p2, v1000, z30, tool0;  
MoveL p3, v1000, fine, tool0;  
PathAccLim FALSE, FALSE;
```

TCP acceleration is limited to 4 m/s^2 between p1 and p3.

Example 2

```
MoveL p1, v1000, fine, tool0;  
MoveL p2, v1000, z30, tool0;  
PathAccLim TRUE\AccMax :=3, TRUE\DecelMax := 4;  
MoveL p3, v1000, fine, tool0;  
PathAccLim FALSE, FALSE;
```

TCP acceleration is limited to 3 m/s^2 between p2' and p3.

TCP deceleration is limited to 4 m/s^2 between p2' and p3.

Error handling

The following recoverable errors are generated and can be handled in an error handler. The system variable `ERRNO` will be set to:

Name	Cause of error
<code>ERR_ACC_TOO_LOW</code>	The parameter <code>\AccMax</code> or <code>\DecelMax</code> is set too low.

Limitations

The minimum acceleration/deceleration allowed is 0.1 m/s^2 . The recommendation is to have the acceleration and deceleration limit symmetrical, that is to have the same value on `AccMax` and `DecelMax`.

Syntax

```
PathAccLim  
[ AccLim ':' ] < expression (IN) of bool >  
[ '\ AccMax ':' ] < expression (IN) of num > ] ','  
[ DecelLim ':' ] < expression (IN) of bool >
```

Continues on next page

1.168 PathAccLim - Reduce TCP acceleration along the path

RobotWare Base
Continued

```
[ '\ ' DecelMax ' := ' <expression (IN) of num > ] ';' 
```

Related information

For information about	See
Reduction of acceleration	AccSet - Reduces the acceleration on page 25
Motion settings data	motsetdata - Motion settings data on page 1692
Control acceleration in world coordinate system	WorldAccLim - Control acceleration in world coordinate system on page 1093
Positioning instructions	<i>Technical reference manual - RAPID Overview, section RAPID summary - Motion</i>

1 Instructions

1.169 PathLengthReset - Resets the current path-length value of the counter

RobotWare Base

1.169 PathLengthReset - Resets the current path-length value of the counter

Usage

`PathLengthReset` is used to reset the counter that monitors the path-length travelled by the robot's TCP.

This instruction can be called at any time, but it is advisable that it is called when the robot is standing still to get a predictable behavior for the counter.

This instruction can only be used in the main task `T_ROB1` or, if in a MultiMove system, in Motion tasks.

Basic examples

The following example illustrates the instruction `PathLengthReset`.

Example 1

```
PathLengthStart;  
MoveJ p10, v1000, z50, L10tip;  
...  
MoveL p40, v1000, fine, L10tip;  
PathLengthStop;  
TPWrite "PathLengthGet: "+ValToStr(PathLengthGet());  
PathLengthReset;
```

This example read out the value of the counter that measures the path-length travelled by the robot's TCP. The value is then written to the FlexPendant.

Program execution

The path-length measurement applies for the next executed robot movement instruction of any type and is valid until a `PathLengthStop` instruction is executed.

Path-length measurement is set to off, and the path-length measurement counter is set to zero when a `PathLengthReset` instruction is executed. The default value, path-length measurement off is automatically set:

- when using the restart mode *Reset RAPID*.
- when loading a new program or a new module.
- when starting program execution from the beginning.
- when moving the program pointer to Main routine.
- when moving the program pointer to a routine.
- when moving the program pointer in such a way that the execution order is lost.

Limitations

Path-length measurements are only applicable for TCP-robots.

Syntax

```
PathLengthReset';'
```

Continues on next page

1.169 PathLengthReset - Resets the current path-length value of the counter

RobotWare Base

Continued

Related information

For information about	See
PathLengthGet	PathLengthGet - Reads the current path-length value of the counter on page 1395
PathLengthStart	PathLengthStart - Activates the counter that monitors the path-length on page 518
PathLengthStop	PathLengthStop - Stops the counter that monitors the path-length on page 520

1 Instructions

1.170 PathLengthStart - Activates the counter that monitors the path-length *RobotWare Base*

1.170 PathLengthStart - Activates the counter that monitors the path-length

Usage

`PathLengthStart` is used to activate the counter that monitors the path-length travelled by the robot's TCP, starting from the next Move-instruction. The path length is always measured in the work object. Note that the internal counter for the TCP-length is not reset by this instruction. To reset the counter, use the instruction `PathLengthReset`.

This instruction can only be used in the main task `T_ROB1` or, if in a MultiMove system, in Motion tasks.

Basic examples

The following example illustrates the instruction `PathLengthStart`.

Example 1

```
PathLengthStart;  
MoveJ p10, v1000, z50, L10tip;  
...  
MoveL p40, v1000, fine, L10tip;  
PathLengthStop;  
TPWrite "PathLengthGet: "+ValToStr(PathLengthGet());  
PathLengthReset;
```

This example read out the value of the counter that measures the path-length travelled by the robot's TCP. The value is then written to the FlexPendant.

Program execution

The path-length measurement applies for the next executed robot movement instruction of any type and is valid until a `PathLengthStop` instruction is executed. Path-length measurement is set to off, and the path-length measurement counter is set to zero when a `PathLengthReset` instruction is executed. The default value, path-length measurement off is automatically set:

- when using the restart mode *Reset RAPID*.
- when loading a new program or a new module.
- when starting program execution from the beginning.
- when moving the program pointer to Main routine.
- when moving the program pointer to a routine.
- when moving the program pointer in such a way that the execution order is lost.

Limitations

Path-length measurements are only applicable for TCP-robots.

Syntax

```
PathLengthStart';'
```

Continues on next page

1.170 PathLengthStart - Activates the counter that monitors the path-length

RobotWare Base

Continued

Related information

For information about	See
PathLengthReset	PathLengthReset - Resets the current path-length value of the counter on page 516
PathLengthGet	PathLengthGet - Reads the current path-length value of the counter on page 1395
PathLengthStop	PathLengthStop - Stops the counter that monitors the path-length on page 520

1 Instructions

1.171 PathLengthStop - Stops the counter that monitors the path-length

RobotWare Base

1.171 PathLengthStop - Stops the counter that monitors the path-length

Usage

`PathLengthStop` is used to stop the counter that monitors the path-length travelled by the robot's TCP, starting from the next Move-instruction.

The path length is always measured in the work object. Note that the internal counter for the TCP-length is not reset by this instruction. To reset the counter, use the instruction `PathLengthReset`.

This instruction can only be used in the main task `T_ROB1` or, if in a MultiMove system, in Motion tasks.

Basic examples

The following example illustrates the instruction `PathLengthStop`.

Example 1

```
PathLengthStart;
MoveJ p10, v1000, z50, L10tip;
...
MoveL p40, v1000, fine, L10tip;
PathLengthStop;
TPWrite "PathLengthGet: "+ValToStr(PathLengthGet());
PathLengthReset;
```

This example read out the value of the counter that measures the path-length travelled by the robot's TCP. The value is then written to the FlexPendant.

Program execution

The path-length measurement applies for the next executed robot movement instruction of any type and is valid until a `PathLengthStop` instruction is executed.

Path-length measurement is set to off, and the path-length measurement counter is set to zero when a `PathLengthReset` instruction is executed. The default value, path-length measurement off is automatically set:

- when using the restart mode *Reset RAPID*.
- when loading a new program or a new module.
- when starting program execution from the beginning.
- when moving the program pointer to Main routine.
- when moving the program pointer to a routine.
- when moving the program pointer in such a way that the execution order is lost.

Limitations

Path-length measurements are only applicable for TCP-robots.

Syntax

```
PathLengthStop';'
```

Continues on next page

1.171 PathLengthStop - Stops the counter that monitors the path-length

RobotWare Base

Continued

Related information

For information about	See
PathLengthReset	PathLengthReset - Resets the current path-length value of the counter on page 516
PathLengthGet	PathLengthGet - Reads the current path-length value of the counter on page 1395
PathLengthStart	PathLengthStart - Activates the counter that monitors the path-length on page 518

1 Instructions

1.172 PathRecMoveBwd - Move path recorder backwards

Path Recovery

1.172 PathRecMoveBwd - Move path recorder backwards

Usage

PathRecMoveBwd is used to move the robot backwards along a recorded path.

Basic examples

The following example illustrates the instruction PathRecMoveBwd:

See also [More examples on page 523](#).

Example 1

```
VAR pathrecid fixture_id;  
PathRecMoveBwd \ID:=fixture_id \ToolOffs:=[0, 0, 10] \Speed:=v500;
```

The robot is moved backwards to the position in the program where the instruction PathRecStart planted the fixture_id identifier. The TCP offset is 10 mm in Z direction and the speed is set to 500 mm/s.

Arguments

```
PathRecMoveBwd [\ID] [\ToolOffs] [\Speed]
```

[\ID]

Identifier

Data type: pathrecid

Variable that specifies the ID position to move backward to. Data type pathrecid is a non-value type, only used as an identifier for naming the recording position.

If no ID position is specified then the backward movement is in a single system done to the closest recorded ID position. But in a MultiMove Synchronized Mode, the backward movements is done to the closest of the following positions:

- Back to the position where the synchronized movement started
- Back to the closest recorded ID position

[\ToolOffs]

Tool Offset

Data type: pos

Provides clearance offset for TCP during motion. A cartesian offset coordinate is applied to the TCP coordinates. Positive Z offset value indicates clearance. This is useful when the robot runs a process adding material. If running synchronized motion then all or none of the mechanical units needs to use the argument. If no offset is desired for some of the mechanical units then a zero offset can be applied. Even non TCP mechanical units need to use the argument if a TCP robot in a different task is used.

[\Speed]

Data type: speeddata

Speed replaces the speed original used during forward motion. Speeddata defines the velocity for the tool center point, the tool reorientation, and the external axis. If present, this speed will be used throughout the backward movement. If omitted, the backward motion will execute with the speed in the original motion instructions.

Continues on next page

Program execution

The path recorder is activated with the `PathRecStart` instruction. After the recorder has been started then all move instructions will be recorded and the robot can be moved backwards along its recorded path at any point by executing `PathRecMoveBwd`.

Synchronized motion

Running the path recorder in synchronization motion adds a few considerations.

- All tasks involved in the synchronization recorded motion must order `PathRecMoveBwd` before any of the robots start to move.
- All synchronization handling is recorded and executed in reverse. For example, if `PathRecMoveBwd` is ordered from within a synchronization block to an independent position then the path recorder will automatically change state to independent at the `SyncMoveOn` instruction.
- `SyncMoveOn` is considered as a breakpoint without path identifier. That is, if the path recorder has been started by means of `PathRecStart` and `PathRecMoveBwd` without the optional argument `\ID` is executed within a synchronized motion block, then the robot will move backwards to the position the robot was at when `SyncMoveOn` was executed. Since the backward movement stops before `SyncMoveOn`, the state will be changed to independent.
- `WaitSyncTask` is considered as a breakpoint without path identifier. That is, if the path recorder has been started by the means of `PathRecStart` and `PathRecMoveBwd` is executed then the robot will move back no longer than to the position the robot was at when `WaitSyncTask` was executed.

More examples

More examples of how to use the instruction `PathRecMoveBwd` are illustrated below.

Example 1 - Independent motion

```
VAR pathrecid safe_id;
CONST robtarget p0 := [...];
...
CONST robtarget p4 := [...];
VAR num choice;

MoveJ p0, vmax, z50, tool1;
PathRecStart safe_id;
MoveJ p1, vmax, z50, tool1;
MoveL p2, vmax, z50, tool1;
MoveL p3, vmax, z50, tool1;
MoveL p4, vmax, z50, tool1;

ERROR:
```

Continues on next page

1 Instructions

1.172 PathRecMoveBwd - Move path recorder backwards

Path Recovery

Continued

```
TPReadFK choice,"Go to safe?",stEmpty,stEmpty,stEmpty,stEmpty,"Yes";
  IF choice=5 THEN
    IF PathRecValidBwd(\ID:=safe_id) THEN
      StorePath;
      PathRecMoveBwd \ID:=safe_id \ToolOffs:=[0, 0 , 10];
      Stop;
      !Fix problem
      PathRecMoveFwd;
      RestoPath;
      StartMove;
      RETRY;
    ENDIF
  ENDIF
```

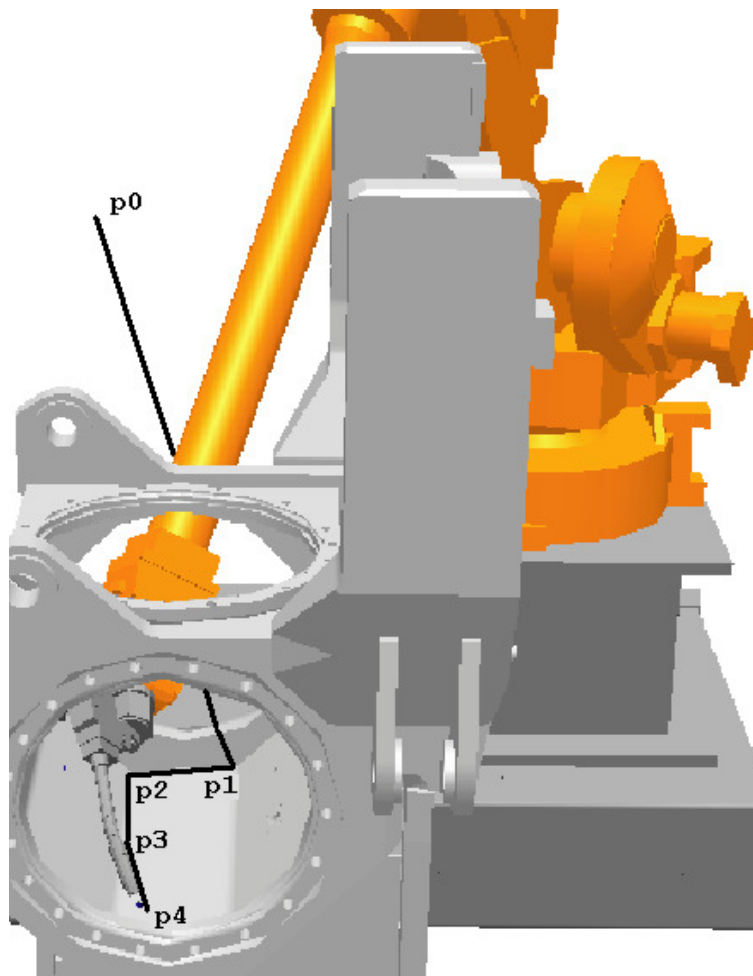

xx0500002135

This example shows how the path recorder can be utilized to extract the robot from narrow spaces upon error without programming a designated path.

A part is being manufactured. At the approach point, p_0 , the path recorder is started and given the path recorder identifier `safe_id`. Assume that when the robot moves from p_3 to p_4 that a recoverable error arises. At that point the path is stored by executing `StorePath`. By storing the path the error handler can start a new movement and later on restart the original movement. When the path has

Continues on next page

been stored the path recorder is used to move the robot out to the safe position, p0, by executing PathRecMoveBwd.

Note that a tool offset is applied to provide clearance from, for example, a newly added weld. When the robot has been moved out the operator can do what is necessary to fix the error (for example clean the torch of welding). Then the robot is moved back to the error location by the means of PathRecMoveFwd. At the error location the path level is switched back to base level by RestoPath and a retry attempt is made.

Example 2 - Synchronized motion

T_ROB1

```

VAR pathrecid HomeROB1;
CONST robtarget pR1_10:=[...];
...
CONST robtarget pR1_60:=[...];

PathRecStart HomeROB1;
MoveJ pR1_10, v1000, z50, tGun;
MoveJ pR1_20, v1000, z50, tGun;
MoveJ pR1_30, v1000, z50, tGun;
SyncMoveOn sync1, tasklist;
MoveL pR1_40 \ID:=1, v1000, z50, tGun\wobj:=pos1;
MoveL pR1_50 \ID:=2, v1000, z50, tGun\wobj:=pos1;
MoveL pR1_60 \ID:=3, v1000, z50, tGun\wobj:=pos1;
SyncMoveOff sync2;

ERROR
  StorePath \KeepSync;
  TEST ERRNO
  CASE ERR_PATH_STOP:
    PathRecMoveBwd \ID:= HomeROB1\ToolOffs:=[0,0,10];
  ENDTEST
  !Perform service action
  PathRecMoveFwd \ToolOffs:=[0,0,10];
  RestoPath;
  StartMove;

```

T_ROB2

```

VAR pathrecid HomeROB2;
CONST robtarget pR2_10:=[...];
...
CONST robtarget pR2_50:=[...];

PathRecStart HomeROB2;
MoveJ pR2_10, v1000, z50, tGun;
MoveJ pR2_20, v1000, z50, tGun;
SyncMoveOn sync1, tasklist;
MoveL pR2_30 \ID:=1, v1000, z50, tGun\wobj:=pos1;
MoveL pR2_40 \ID:=2, v1000, z50, tGun\wobj:=pos1;
MoveL pR2_50 \ID:=3, v1000, z50, tGun\wobj:=pos1;
SyncMoveOff sync2;

```

Continues on next page

1 Instructions

1.172 PathRecMoveBwd - Move path recorder backwards

Path Recovery

Continued

```
ERROR
  StorePath \KeepSync;
  TEST ERRNO
  CASE ERR_PATH_STOP:
    PathRecMoveBwd \ToolOffs:=[0,0,10];
  ENDTEST
  !Perform service action
  PathRecMoveFwd \ToolOffs:=[0,0,10];
  RestoPath;
  StartMove;
```

T_ROB3

```
VAR pathrecid HomePOS1;
CONST jointtarget jP1_10:=[...];
...
CONST jointtarget jP1_40:=[...];

PathRecStart HomePOS1;
MoveExtJ jP1_10, v1000, z50;
SyncMoveOn sync1, tasklist;
MoveExtJ jP1_20 \ID:=1, v1000, z50;
MoveExtJ jP1_30 \ID:=2, v1000, z50;
MoveExtJ jP1_40 \ID:=3, v1000, z50;
SyncMoveOff sync2;

ERROR
  StorePath \KeepSync;
  TEST ERRNO
  CASE ERR_PATH_STOP:
    PathRecMoveBwd \ToolOffs:=[0,0,0];
  DEFAULT:
    PathRecMoveBwd \ID:=HomePOS1\ToolOffs:=[0,0,0];
  ENDTEST
  !Perform service action
  PathRecMoveFwd \ToolOffs:=[0,0,0];
  RestoPath;
  StartMove;
```

A system is consisting of three manipulators that all run in separate tasks. Assume that T_ROB1 experiences an error ERR_PATH_STOP within the synchronized block, sync1. Upon error it is desired to move back to the home position marked with the path recorder identifier HomeROB1 to perform service of the robot's external equipment. This is done by using PathRecMoveBwd and supplying the pathrecid identifier.

Since the error occurred during synchronized motion it is necessary that the second TCP robot T_ROB2 and the external axis T_POS1 also orders PathRecMoveBwd. These manipulators do not have to move back further than before the synchronized motion started. By not supplying PathRecMoveBwd at ERR_PATH_STOP with a path recorder identifier the path recorder ability to stop after SyncMoveOn is utilized.

Continues on next page

1.172 PathRecMoveBwd - Move path recorder backwards

Path Recovery

Continued

Note that the external axis that does not have a TCP still adds a zero tool offset to enable the possibility for the TCP robots to do so.

The `DEFAULT` behavior in the `ERROR` handler in this example is that all manipulators first do the synchronized movements backwards and then the independent movements backwards to the start point of the recorded path. This is obtained by specifying `\ID` in `PathRecMoveBwd` for all manipulators.

Limitations

Movements using the path recorder cannot be performed on base level, that is, `StorePath` has to be executed before `PathRecMoveBwd`.

It is never possible to move backwards through a `SynchMoveOff` statement.

It is never possible to move backwards through a `WaitSyncTask` statement.

`SyncMoveOn` must be preceded by at least one independent movement if it is desired to move back to the position where the synchronized movement started.

If it is not desired to return to the point where `PathRecMoveBwd` was executed (by executing `PathRecMoveFwd`) then the PathRecorder has to be stopped by the means of `PathRecStop`. `PathRecStop\Clear` also clears the recorded path.

`PathRecMoveBwd` cannot be executed in a `RAPID` routine connected to any of the following special system events: `PowerOn`, `Stop`, `QStop`, `Restart`, `Reset` or `Step`.

Syntax

```
PathRecMoveBwd
  [ '\ ID :=' < variable (VAR) of pathrecid > ]
  [ '\ ToolOffs :=' < expression (IN) of pos > ]
  [ '\ Speed :=' < expression (IN) of speeddata > ] ;'
```

Related information

For information about	See
Path Recorder Identifier	pathrecid - Path recorder identifier on page 1711
Start - stop the path recorder	PathRecStart - Start the path recorder on page 531 PathRecStop - Stop the path recorder on page 534
Check for valid recorded path	PathRecValidBwd - Is there a valid backward path recorded on page 1399 PathRecValidFwd - Is there a valid forward path recorded on page 1402
Move path recorder forward	PathRecMoveFwd - Move path recorder forward on page 528
Store - restore paths	StorePath - Stores the path when an interrupt occurs on page 826 RestoPath - Restores the path after an interrupt on page 618
Other positioning instructions	Technical reference manual - RAPID Overview
Error Recovery	Technical reference manual - RAPID Overview

1 Instructions

1.173 PathRecMoveFwd - Move path recorder forward

PathRecovery

1.173 PathRecMoveFwd - Move path recorder forward

Usage

`PathRecMoveFwd` is used to move the robot back to the position where `PathRecMoveBwd` was executed. It is also possible to move the robot partly forward by supplying an identifier that has been passed during the backward movement.

Basic examples

The following example illustrates the instruction `PathRecMoveFwd`:

See also [More examples on page 529](#).

Example 1

```
PathRecMoveFwd;
```

The robot is moved back to the position where the path recorder started the backward movement.

Arguments

```
PathRecMoveFwd [\ID] [\ToolOffs] [\Speed]
```

`[\ID]`

Identifier

Data type: `pathrecid`

Variable that specifies the ID position to move forward to. Data type `pathrecid` is a non-value type only used as an identifier for naming the recording position.

If no ID position is specified then the forward movement will always be done to interrupt position on the original path.

`[\ToolOffs]`

Tool Offset

Data type: `pos`

Provides clearance offset for TCP during motion. A cartesian coordinate is applied to the TCP coordinates. This is useful when the robot runs a process adding material.

`[\Speed]`

Data type: `speeddata`

Speed overrides the original speed used during forward motion. `Speeddata` defines the velocity for the tool center point, the tool reorientation, and the external axis. If present, this speed will be used throughout the forward movement. If omitted, the forward motion will execute with the speed in the original motion instructions.

Continues on next page

Program execution

The path recorder is activated with the `PathRecStart` instruction. After the recorder has been started the robot can be moved backwards along its executed path by executing `PathRecMoveBwd`. The robot can thereafter be ordered back to the position where the backward execution started by calling `PathRecMoveFwd`. It is also possible to move the robot partly forward by supplying an identifier that has been passed during the backward movement.

More examples

More examples of how to use the instruction `PathRecMoveFwd` are illustrated below.

```

VAR pathrecid start_id;
VAR pathrecid mid_id;
CONST robtarget p1 := [...];
CONST robtarget p2 := [...];
CONST robtarget p3 := [...];

PathRecStart start_id;
MoveL p1, vmax, z50, tool1;
MoveL p2, vmax, z50, tool1;
PathRecStart mid_id;
MoveL p3, vmax, z50, tool1;
StorePath;
PathRecMoveBwd \ID:=start_id;
PathRecMoveFwd \ID:=mid_id;
PathRecMoveFwd;
RestoPath;

```

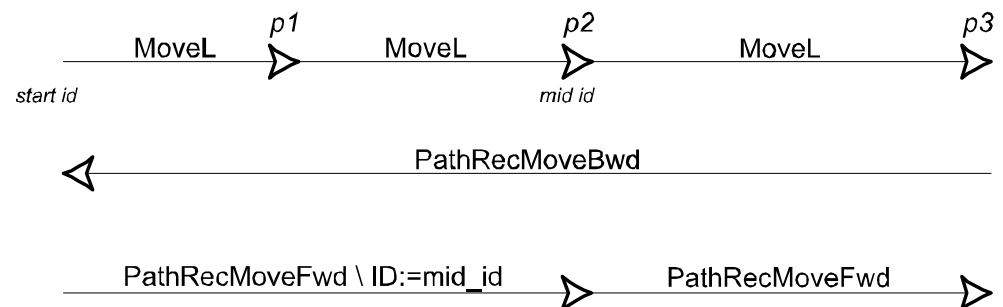

xx0500002133

The example above will start the path recorder and the starting point will be tagged with the path identifier `start_id`. Thereafter the robot will move forward with traditional move instructions and then move back to the path recorder identifier `start_id` using the recorded path. Finally it will move forward again in two steps by the means of `PathRecMoveFwd`.

Limitations

Movements using the path recorder have to be performed on trap-level, i.e. `StorePath` must execute prior to `PathRecMoveFwd`.

Continues on next page

1 Instructions

1.173 PathRecMoveFwd - Move path recorder forward

PathRecovery

Continued

To be able to execute `PathRecMoveFwd` a `PathRecMoveBwd` must have been executed before.

If it is not desired to return to the point where `PathRecMoveBwd` was executed (by executing `PathRecMoveFwd`) then the PathRecorder has to be stopped by the means of `PathRecStop`. `PathRecStop\Clear` also clears recorded path.

`PathRecMoveFwd` cannot be executed in a RAPID routine connected to any of the following special system events: `PowerOn`, `Stop`, `QStop`, `Restart`, `Reset` or `Step`.

Syntax

```
PathRecMoveFwd '('  
  [ '\ ID ' := ' < variable (VAR) of pathid > ]  
  [ '\ ToolOffs ' := ' <expression (IN) of pos> ]  
  [ '\ Speed ' := ' <expression (IN) of speeddata> ]';'
```

Related information

For information about	See
Path Recorder Identifiers	pathrecid - Path recorder identifier on page 1711
Start - stop the path recorder	PathRecStart - Start the path recorder on page 531 PathRecStop - Stop the path recorder on page 534
Check for valid recorded path	PathRecValidBwd - Is there a valid backward path recorded on page 1399 PathRecValidFwd - Is there a valid forward path recorded on page 1402
Move path recorder backward	PathRecMoveBwd - Move path recorder backwards on page 522
Store - restore paths	StorePath - Stores the path when an interrupt occurs on page 826 RestoPath - Restores the path after an interrupt on page 618
Other positioning instructions	Technical reference manual - RAPID Overview
Error Recovery	Technical reference manual - RAPID Overview Technical reference manual - RAPID Overview

1.174 PathRecStart - Start the path recorder

Usage

`PathRecStart` is used to start recording the robot's path. The path recorder will store path information during execution of the RAPID program.

Basic examples

The following example illustrates the instruction `PathRecStart`:

Example 1

```
VAR pathrecid fixture_id;
```

```
PathRecStart fixture_id;
```

The path recorder is started and the starting point (the instruction's position in the RAPID program) is tagged with the identifier `fixture_id`.

Arguments

```
PathRecStart ID
```

ID

Identifier

Data type: `pathrecid`

Variable that specifies the name of the recording start position. Data type `pathrecid` is a non-value type only used as an identifier for naming the recording position.

Program execution

When the path recorder is ordered to start the robot path will be recorded internally in the robot controller. The recorded sequence of program positions can be traversed backwards by means of `PathRecMoveBwd` causing the robot to move backwards along its executed path.

More examples

More examples of how to use the instruction `PathRecStart` are illustrated below.

Example 1

```
VAR pathrecid origin_id;
VAR pathrecid corner_id;
VAR num choice;
MoveJ p1, vmax, z50, tool1;
PathRecStart origin_id;
MoveJ p2, vmax, z50, tool1;
PathRecStart corner_id;
MoveL p3, vmax, z50, tool1;
MoveAbsJ jt4, vmax, fine, tool1;
ERROR
  TPReadFK choice, "Extract
    to: ", stEmpty, stEmpty, stEmpty, "Origin", "Corner";
```

Continues on next page

1 Instructions

1.174 PathRecStart - Start the path recorder

Path Recovery

Continued

```
IF choice=4 OR choice=5 THEN
  StorePath;
  IF choice=4 THEN
    PathRecMoveBwd \ID:=origin_id;
  ELSE
    PathRecMoveBwd \ID:=corner_id;
  ENDIF
  Stop;
  !Fix problem
  PathRecMoveFwd;
  RestoPath;
  StartMove;
  RETRY;
ENDIF
```

In the example above the path recorder is used for moving the robot to a service position if an error during normal execution occurs.

The robot is executing along a path. After the position p_1 the path recorder is started. After the point p_2 another path identifier is inserted. Assume that a recoverable error occurs while moving from position p_3 to position p_4 . The error handler will now be invoked, and the user can choose between extracting the robot to position *Origin* (point p_1) or *Corner* (point p_2). Then the path level is switched with *StorePath* to be able to restart at the error location later on. When the robot has backed out from the error location it is up to the user to solve the error (usually fixing the robot's surrounding equipment).

Then the robot is ordered back to the error location. The path level is switched back to normal, and a retry attempt is made.

Limitations

The path recorder can only be started and will only record the path in the base path level, i.e. movements at *StorePath* level are not recorded.

Syntax

```
PathRecStart
  [ ID := ] < variable (VAR) of pathrecid> ';' 
```

Related information

For information about	See
Path Recorder Identifiers	pathrecid - Path recorder identifier on page 1711
Stop the path recorder	PathRecStop - Stop the path recorder on page 534
Check for valid recorded path	PathRecValidBwd - Is there a valid backward path recorded on page 1399 PathRecValidFwd - Is there a valid forward path recorded on page 1402
Play the path recorder backward	PathRecMoveBwd - Move path recorder backwards on page 522
Play the path recorder forward	PathRecMoveFwd - Move path recorder forward on page 528

Continues on next page

1.174 PathRecStart - Start the path recorder

Path Recovery

Continued

For information about	See
Motion in general	<i>Technical reference manual - RAPID Overview</i>

1 Instructions

1.175 PathRecStop - Stop the path recorder

Path Recovery

1.175 PathRecStop - Stop the path recorder

Usage

`PathRecStop` is used to stop recording the robot's path.

Basic examples

The following example illustrates the instruction `PathRecStop`:

See also *More examples* below.

Example 1

```
PathRecStop \Clear;
```

The path recorder is stopped and the buffer of stored path information is cleared.

Arguments

```
PathRecStop [\Clear]
```

[\Clear]

Data type: switch

Clear the recorded path.

Program execution

When the path recorder is ordered to stop the recording of the path will stop. The optional argument `\Clear` will clear the buffer of stored path information preventing the recorded path to be executed by mistake.

After the recorder has been stopped with `PathRecStop`, earlier recorded paths cannot be used for back-up movements (`PathRecMoveBwd`). It is possible to use earlier recorded paths if `PathRecStart` is ordered again from the same position that the path recorder was stopped in. See the following example.

More examples

More examples of how to use the instruction `PathRecStop` are illustrated below.

```
LOCAL VAR pathrecid id1;  
LOCAL VAR pathrecid id2;  
LOCAL CONST robtarget p0:= [...];  
.....  
LOCAL CONST robtarget p6 := [...];  
PROC example1()  
  MoveL p0, vmax, z50, tool1;  
  PathRecStart id1;  
  MoveL p1, vmax, z50, tool1;  
  MoveL p2, vmax, z50, tool1;  
  PathRecStop;  
  MoveL p3, vmax, z50, tool1;  
  MoveL p4, vmax, z50, tool1;  
  MoveL p2, vmax, z50, tool1;  
  PathRecStart id2;  
  MoveL p5, vmax, z50, tool1;  
  MoveL p6, vmax, z50, tool1;
```

Continues on next page

```

StorePath;
PathRecMoveBwd \ID:=id1;
PathRecMoveFwd;
RestoPath;
StartMove;
MoveL p7, vmax, z50, tool1;
ENDPROC
PROC example2()
MoveL p0, vmax, z50, tool1;
PathRecStart id1;
MoveL p1, vmax, z50, tool1;
MoveL p2, vmax, z50, tool1;
PathRecStop;
MoveL p3, vmax, z50, tool1;
MoveL p4, vmax, z50, tool1;
PathRecStart id2;
MoveL p2, vmax, z50, tool1;
MoveL p5, vmax, z50, tool1;
MoveL p6, vmax, z50, tool1;
StorePath;
PathRecMoveBwd \ID:=id1;
PathRecMoveFwd;
RestoPath;
StartMove;
MoveL p7, vmax, z50, tool1;
ENDPROC

```

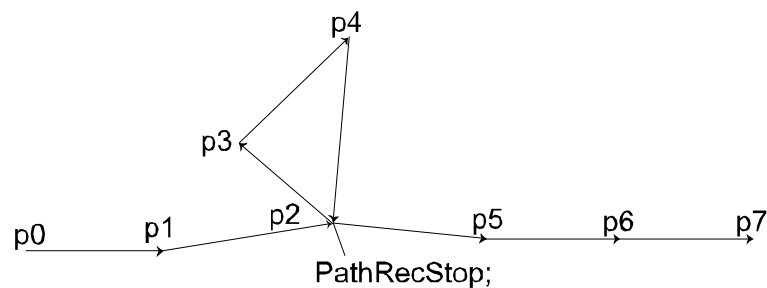

PathRecStop_

The above examples describe recording of the robot path when the recording is stopped in the middle of the sequence. In `example1` the `PathRecMoveBwd \ID:=id1;` order is valid and the robot will execute the following path: `p6 -> p5 -> p2 -> p1 -> p0`

The reason that the order is valid is because of the recorder being stopped and started in the exact same robot position. If this behavior isn't desirable the stop order should include the optional argument `\Clear`. In that way the recorded path will be cleared and it will never be possible to back-up to previous path recorder identifiers.

The only difference in `example2` is where the recorder was started the second time. In this case `PathRecMoveBwd \ID:=id1` will cause an error. This is because no recorded path exists between `p4, p3` and `p2`. It is possible to execute `PathRecMoveBwd \ID:=id2`.

Continues on next page

1 Instructions

1.175 PathRecStop - Stop the path recorder

Path Recovery

Continued

Syntax

```
PathRecStop  
[ '\switch Clear ] ';' 
```

Related information

For information about	See
Path Recorder Identifiers	pathrecid - Path recorder identifier on page 1711
Start the path recorder	PathRecStart - Start the path recorder on page 531
Check for valid recorded path	PathRecValidBwd - Is there a valid backward path recorded on page 1399 PathRecValidFwd - Is there a valid forward path recorded on page 1402
Play the recorder backward	PathRecMoveBwd - Move path recorder backwards on page 522
Play the recorder forwards	PathRecMoveFwd - Move path recorder forward on page 528
Motion in general	Technical reference manual - RAPID Overview

1.176 PathResol - Override path resolution

Usage

`PathResol` (*Path Resolution*) is used to override the configured geometric path sample time defined in the system parameters for the mechanical units that are controlled from current program task.

The geometric path sample time is used in applications with sensor inputs. Observe that it is not used for defining the geometric path in normal application, a legacy functionality.

This instruction can only be used in the main task `T_ROB1` or, if in a *MultiMove* system, in any motion tasks.

Description

Example of when to use `PathResol`:

- Using coordinated interpolation.
- Using *Weldguide*.
- Using the option *Conveyor Tracking*.

Basic examples

The following example illustrates the instruction `PathResol`:

```
MoveJ p1,v1000,fine,tool1;
PathResol 150;
```

With the robot at a stop point the path sample time is increased to 150 % of the configured value.

Arguments

```
PathResol PathSampleTime
```

`PathSampleTime`

Data type: num

Override as a percent of the configured path sample time. 100% corresponds to the configured path sample time. Within the range 25-400%.

Program execution

The path resolutions of all subsequent positioning instructions are affected until a new `PathResol` instruction is executed. This will affect the path resolution during all program execution of movements (default path level and path level after `StorePath`) and also during jogging.

In a *MultiMove* system at synchronized coordinated mode the following points are valid:

- All mechanical units involved in synchronized coordinated mode will run with the current path resolution for actual (used) motion planner.
- New path resolution order against actual motion planner affects the synchronized coordinated movement and future independent movement in that motion planner.

Continues on next page

1 Instructions

1.176 PathResol - Override path resolution

RobotWare Base

Continued

- New path resolution order against another motion planner only affects future independent movement in that motion planner.

About connection between program task and motion planner see *Application manual - MultiMove*.

The default value for override of path sample time is 100%. This value is automatically set

- when using the restart mode **Reset RAPID**
- when loading a new program or a new module
- when starting program execution from the beginning
- when moving the program pointer to `main`
- when moving the program pointer to a routine
- when moving the program pointer in such a way that the execution order is lost.

The current override of path sample time can be read from the variable `C_MOTSET` (data type `motsetdata`) in the component `pathresol`.

Limitation

If this instruction is preceded by a move instruction then that move instruction must be programmed with a stop point (zonedata `fine`), not a fly-by point. Otherwise restart after power failure will not be possible.

`PathResol` cannot be executed in a RAPID routine connected to any of following special system events: PowerOn, Stop, QStop, Restart, or Step.

Syntax

```
PathResol  
  [PathSampleTime ' := ' ] <expression (IN) of num>';'
```

Related information

For information about	See
Positioning instructions	<i>Technical reference manual - RAPID Overview</i>
Motion settings	<i>Technical reference manual - RAPID Overview</i>
Configuration of path resolution	<i>Technical reference manual - System parameters</i>
Motion settings data	motsetdata - Motion settings data on page 1692

1.177 PDispOff - Deactivates program displacement

Usage

`PDispOff` (*Program Displacement Off*) is used to deactivate a program displacement.

Program displacement is activated by the instruction `PDispSet` or `PDispOn` and applies to all movements until some other program displacement is activated or until program displacement is deactivated.

This instruction can only be used in the main task `T_ROB1` or, if in a *MultiMove* system, in Motion tasks.

Basic examples

The following examples illustrate the instruction `PDispOff`:

Example 1

```
PDispOff;
```

Deactivation of a program displacement.

Example 2

```
MoveL p10, v500, z10, tool1;
PDispOn \ExeP:=p10, p11, tool1;
MoveL p20, v500, z10, tool1;
MoveL p30, v500, z10, tool1;
PDispOff;
MoveL p40, v500, z10, tool1;
```

A program displacement is defined as the difference between the positions `p10` and `p11`. This displacement affects the movement to `p20` and `p30` but not to `p40`.

Program execution

Active program displacement is reset. This means that the program displacement coordinate system is the same as the object coordinate system, and thus all programmed positions will be related to the latter.

Syntax

```
PDispOff ';' ;'
```

Related information

For information about	See
Definition of program displacement using two positions	PDispOn - Activates program displacement on page 540
Definition of program displacement using known frame	PDispSet - Activates program displacement using known frame on page 545

1 Instructions

1.178 PDispOn - Activates program displacement

RobotWare Base

1.178 PDispOn - Activates program displacement

Usage

PDispOn (*Program Displacement On*) is used to define and activate a program displacement using two robot positions.

Program displacement is used, for example, after a search has been carried out or when similar motion patterns are repeated at several different places in the program.

This instruction can only be used in the main task T_ROB1 or, if in a *MultiMove* system, in Motion tasks.

Basic examples

The following examples illustrate the instruction PDispOn:

See also [More examples on page 542](#).

Example 1

```
MoveL p10, v500, z10, tool1;  
PDispOn \ExeP:=p10, p20, tool1;
```

Activation of a program displacement (parallel displacement). This is calculated based on the difference between positions p10 and p20.

Example 2

```
MoveL p10, v500, fine \Inpos := inpos50, tool1;  
PDispOn *, tool1;
```

Activation of a program displacement (parallel displacement). Since a stop point that is accurately defined has been used in the previous instruction the argument \ExeP does not have to be used. The displacement is calculated on the basis of the difference between the robot's actual position and the programmed point (*) stored in the instruction.

Example 3

```
PDispOn \Rot \ExeP:=p10, p20, tool1;
```

Activation of a program displacement including a rotation. This is calculated based on the difference between positions p10 and p20.

Arguments

```
PDispOn [\Rot] [\ExeP] ProgPoint Tool [\WObj]
```

[\Rot]

Rotation

Data type: switch

The difference in the tool orientation is taken into consideration and this involves a rotation of the program.

[\ExeP]

Executed Point

Data type: robtarget

Continues on next page

The new robot position used for calculation of the displacement. If this argument is omitted then the robot's current position at the time of the program execution is used.

ProgPoint

Programmed Point

Data type: robtarget

The robot's original position at the time of programming.

Tool

Data type: tooldata

The tool used during programming, i.e. the TCP to which the ProgPoint position is related.

[\WObj]

Work Object

Data type: wobjdata

The work object (coordinate system) to which the ProgPoint position is related.

This argument can be omitted and if so then the position is related to the world coordinate system. If a stationary TCP or coordinated external axes are used then this argument must be specified.

The arguments **Tool** and **\WObj** are used both to calculate the ProgPoint during programming and to calculate the current position during program execution if no **\ExeP** argument is programmed.

Program execution

Program displacement means that the ProgDisp coordinate system is translated in relation to the object coordinate system. Since all positions are related to the ProgDisp coordinate system, all programmed positions will also be displaced. See figure below, which shows parallel displacement of a programmed position using program displacement.

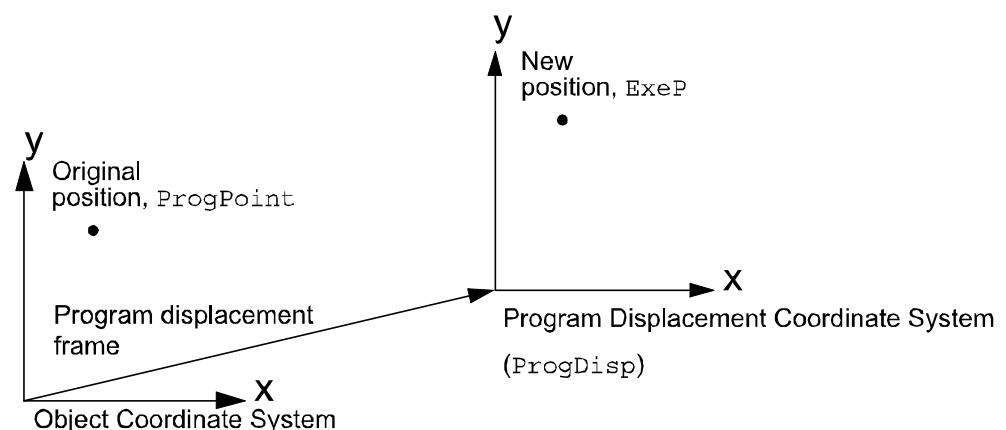

xx0500002186

Program displacement is activated when the instruction PDispOn is executed and remains active until some other program displacement is activated (the instruction

Continues on next page

1 Instructions

1.178 PDispOn - Activates program displacement

RobotWare Base

Continued

PDispSet or PDispOn) or until program displacement is deactivated (the instruction PDispOff).

Only one program displacement can be active at the same time. Several PDispOn instructions, on the other hand, can be programmed one after the other and in this case the different program displacements will be added.

Program displacement is calculated as the difference between ExeP and ProgPoint. If ExeP has not been specified then the current position of the robot at the time of the program execution is used instead. Since it is the actual position of the robot that is used, the robot should not move when PDispOn is executed.

If the argument \Rot is used then the rotation is also calculated based on the tool orientation at the two positions. The displacement will be calculated in such a way that the new position (ExeP) will have the same position and orientation in relation to the displaced coordinate system, ProgDisp, as the old position (ProgPoint) had in relation to the original object coordinate system. See the figure below, which shows translation and rotation of a programmed position.

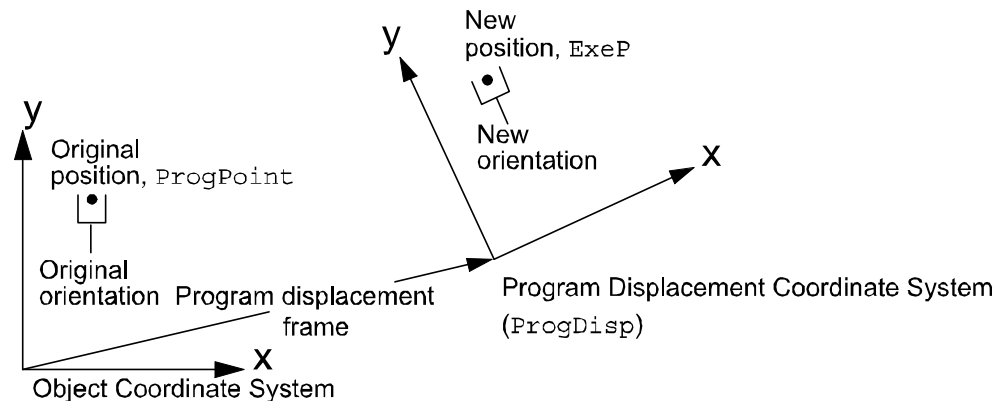

xx0500002187

The program displacement is automatically reset

- when using the restart mode **Reset RAPID**
- when loading a new program or a new module
- when starting program execution from the beginning
- when moving the program pointer to `main`
- when moving the program pointer to a routine
- when moving the program pointer in such a way that the execution order is lost.

More examples

More examples of how to use the instruction PDispOn are illustrated below.

Example 1

```
PROC draw_square()  
  PDispOn *, tool1;  
  MoveL *, v500, z10, tool1;  
  MoveL *, v500, z10, tool1;  
  MoveL *, v500, z10, tool1;
```

Continues on next page

```

MoveL *, v500, z10, tool1;
PDispOff;
ENDPROC
...
MoveL p10, v500, fine \Inpos := inpos50, tool1;
draw_square;
MoveL p20, v500, fine \Inpos := inpos50, tool1;
draw_square;
MoveL p30, v500, fine \Inpos := inpos50, tool1;
draw_square;

```

The routine `draw_square` is used to execute the same motion pattern at three different positions based on the positions `p10`, `p20`, and `p30`. See the figure below, which shows that when using program displacement the motion patterns can be reused.

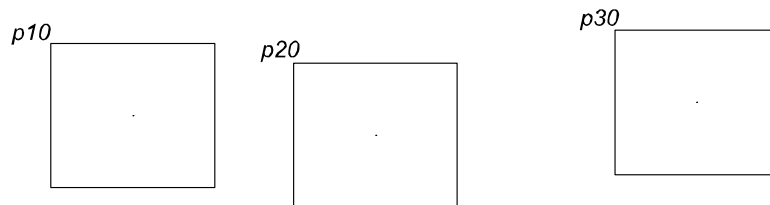

xx0500002185

Example 2

```

SearchL sen1, psearch, p10, v100, tool1\WObj:=fixture1;
PDispOn \ExeP:=psearch, *, tool1 \WObj:=fixture1;

```

A search is carried out in which the robot's searched position is stored in the position `psearch`. Any movement carried out after this starts from this position using a program displacement (parallel displacement). The latter is calculated based on the difference between the searched position and the programmed point (*) stored in the instruction. All positions are based on the `fixture1` object coordinate system.

Syntax

```

PDispOn
[[ '\ ' Rot ]
[ '\ ' ExeP ':' <expression (IN) of robtarg> ',' ]
[ ProgPoint ':' <expression (IN) of robtarg> ',' ]
[ Tool ':' <persistent (PERS) of tooldata> ]
[ '\ ' WObj ':' <persistent (PERS) of wobjdata> '];'

```

Related information

For information about	See
Deactivation of program displacement	PDispOff - Deactivates program displacement on page 539
Definition of program displacement using known frame	PDispSet - Activates program displacement using known frame on page 545
Coordinate systems	Technical reference manual - System parameters

Continues on next page

1 Instructions

1.178 PDispOn - Activates program displacement

RobotWare Base

Continued

For information about	See
Definition of tools	tooldata - Tool data on page 1776
Definition of work objects	wobjdata - Work object data on page 1803

1.179 PDispSet - Activates program displacement using known frame

Usage

`PDispSet` (*Program Displacement Set*) is used to define and activate a program displacement using known frame.

Program displacement is used, for example, when similar motion patterns are repeated at several different places in the program.

This instruction can only be used in the main task `T_ROB1` or, if in a *MultiMove* system, in Motion tasks.

Basic examples

The following example illustrates the instruction `PDispSet`:

Example 1

```
VAR pose xp100 := [ [100, 0, 0], [1, 0, 0, 0] ];
...
PDispSet xp100;
```

Activation of the `xp100` program displacement meaning that:

- The `ProgDisp` coordinate system is displaced 100 mm from the object coordinate system in the direction of the positive x-axis (see figure below).
- As long as this program displacement is active all positions will be displaced 100 mm in the direction of the x-axis.

The figure shows a 100 mm program displacement along the x-axis.

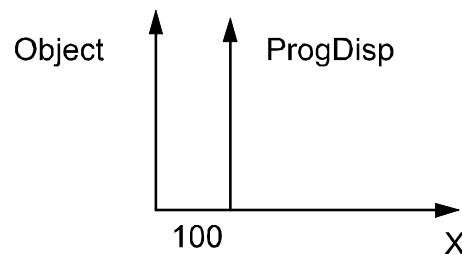

xx0500002199

Arguments

```
PDispSet DispFrame
```

DispFrame

Displacement Frame

Datatype: `pose`

The program displacement is defined as data of the type `pose`.

Continues on next page

1 Instructions

1.179 PDispSet - Activates program displacement using known frame

RobotWare Base

Continued

Program execution

Program displacement involves translating and/or rotating the `ProgDisp` coordinate system relative to the object coordinate system. Since all positions are related to the `ProgDisp` coordinate system, all programmed positions will also be displaced. See the figure below, which shows translation and rotation of a programmed position.

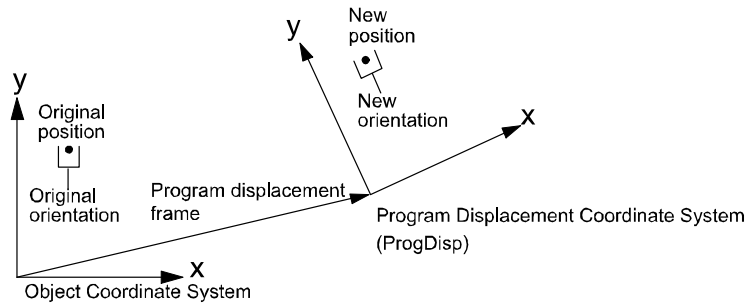

xx0500002204

Program displacement is activated when the instruction `PDispSet` is executed and remains active until some other program displacement is activated (the instruction `PDispSet` or `PDispOn`) or until program displacement is deactivated (the instruction `PDispOff`).

Only one program displacement can be active at the same time. Program displacements cannot be added to one another using `PDispSet`.

The program displacement is automatically reset

- when using the restart mode **Reset RAPID**
- when loading a new program or a new module
- when starting program execution from the beginning
- when moving the program pointer to `main`
- when moving the program pointer to a routine
- when moving the program pointer in such a way that the execution order is lost.

Syntax

```
PDispSet  
  [ DispFrame '=' ] < expression (IN) of pose> ';' ;
```

Related information

For information about	See
Deactivation of program displacement	PDispOff - Deactivates program displacement on page 539
Definition of program displacement using two positions	PDispOn - Activates program displacement on page 540
Definition of data of the type pose	pose - Coordinate transformations on page 1717
Coordinate systems	Technical reference manual - RAPID Overview

Continues on next page

1.179 PDispSet - Activates program displacement using known frame

RobotWare Base

Continued

For information about	See
Examples of how program displacement can be used	PDispOn - Activates program displacement on page 540

1 Instructions

1.180 ProcCall - Calls a new procedure
RobotWare Base

1.180 ProcCall - Calls a new procedure

Usage

A procedure call is used to transfer program execution to another procedure. When the procedure has been fully executed the program execution continues with the instruction following the procedure call.

It is usually possible to send a number of arguments to the new procedure. These control the behavior of the procedure and make it possible for the same procedure to be used for different things.

Basic examples

The following examples illustrate the instruction `ProcCall`:

Example 1

```
weldpipe1;
```

Calls the `weldpipe1` procedure.

Example 2

```
errormessage;  
Set dol;  
...  
PROC errormessage()  
  TPWrite "ERROR";  
ENDPROC
```

The `errormessage` procedure is called. When this procedure is ready the program execution returns to the instruction following the procedure call, `Set dol`.

Arguments

```
Procedure { Argument }
```

Procedure

Identifier

The name of the procedure to be called.

Argument

Data type: In accordance with the procedure declaration.

The procedure arguments (in accordance with the parameters of the procedure).

Basic examples

Basic examples of the instruction `ProcCall` are illustrated below.

Example 1

```
weldpipe2 10, lowspeed;
```

Calls the `weldpipe2` procedure including two arguments.

Example 2

```
weldpipe3 10 \speed:=20;
```

Calls the `weldpipe3` procedure including one mandatory and one optional argument.

Continues on next page

Limitations

The procedure's arguments must agree with its parameters:

- All mandatory arguments must be included.
- They must be placed in the same order.
- They must be of the same data type.
- They must be of the correct type with respect to the access-mode (input, variable, or persistent).

A routine can call a routine which, in turn, calls another routine. A routine can also call itself, that is, a recursive call. The number of routine levels permitted depends on the number of parameters. More than 10 levels are usually permitted.

Syntax

```
<procedure> [ <argument list> ] ';' 
```

Related information

For information about	See
Arguments, parameters	<i>Technical reference manual - RAPID Overview</i>

1 Instructions

1.181 ProcerrRecovery - Generate and recover from process-move error *RobotWare Base*

1.181 ProcerrRecovery - Generate and recover from process-move error

Usage

`ProcerrRecovery` can be used to generate process error during robot movement and get the possibility to handle the error and restart the process and the movement from an `ERROR` handler.

Basic examples

The following examples illustrate the instruction `ProcerrRecovery`:

See also [More examples on page 552](#).

The examples below are not realistic but are shown for pedagogic reasons.

Example 1

```
MoveL p1, v50, z30, tool2;
ProcerrRecovery \SyncOrgMoveInst;
MoveL p2, v50, z30, tool2;
ERROR
  IF ERRNO = ERR_PATH_STOP THEN
    StartMove;
    RETRY;
  ENDIF
```

The robot movement stops on its way to `p1` and the program execution transfers to the `ERROR` handler in the routine that created the actual path on which the error occurred, in this case the path to `MoveL p1`. The movement is restarted with `StartMove` and the execution is continued with `RETRY`.

Example 2

```
MoveL p1, v50, fine, tool2;
ProcerrRecovery \SyncLastMoveInst;
MoveL p2, v50, z30, tool2;
ERROR
  IF ERRNO = ERR_PATH_STOP THEN
    StartMove;
    RETRY;
  ENDIF
```

The robot movement stops at once on its way to `p2`. The program execution transfers to the `ERROR` handler in the routine where the program is currently executing or is going to execute a move instruction when the error occurred, in this case `MoveL p2`. The movement is restarted with `StartMove` and the execution is continued with `RETRY`.

Arguments

```
ProcerrRecovery[\SyncOrgMoveInst] | [\SyncLastMoveInst]
[\ProcSignal]
```

`[\SyncOrgMoveInst]`

Data type: switch

Continues on next page

1.181 ProcerrRecovery - Generate and recover from process-move error

RobotWare Base

Continued

The error can be handled in the routine that created the actual path on which the error occurred.

[\SyncLastMoveInst]

Data type: switch

The error can be handled in the routine where the program is currently executing a move instruction when the error occurred.

If the program is currently not executing a move instruction when the error occurred then the transfer of the execution to the `ERROR` handler will be delayed until the program executes the next move instruction. This means that the transfer to the `ERROR` handler will be delayed if the robot is in a stop point or between the prefetch point and the middle of the corner path. The error can be handled in that routine.

[\ProcSignal]

Data type: signaldo

Optional parameter that let the user turn on/off the use of the instruction. If this parameter is used and the signal value is 0, an recoverable error will be thrown, and no process error will be generated.

Program execution

Execution of `ProcerrRecovery` in continuous mode results in the following:

- At once the robot is stopped on its path.
- The variable `ERRNO` is set to `ERR_PATH_STOP`.
- The execution is transferred to some `ERROR` handler according the rules for asynchronously raised errors.

This instruction does nothing in any step mode.

For description of asynchronously raised errors that are generated with `ProcerrRecovery`, see *Technical reference manual - RAPID kernel*.

`ProcerrRecovery` can also be used in MultiMove system to transfer the execution to the `ERROR` handler in several program tasks if running in synchronized mode.

Error handling

The following recoverable errors are generated and can be handled in an error handler. The system variable `ERRNO` will be set to:

Name	Cause of error
<code>ERR_NO_ALIASIO_DEF</code>	The signal variable is a variable declared in RAPID. It has not been connected to an I/O signal defined in the I/O configuration with instruction <code>AliasIO</code> .
<code>ERR_NORUNUNIT</code>	There is no contact with the I/O device.
<code>ERR_PATH_STOP</code>	Execution of <code>ProcerrRecovery</code> in continuous mode.
<code>ERR_PROCSIGNAL_OFF</code>	The optional parameter <code>\ProcSignal</code> is used and the signal is off when the instruction is executed.
<code>ERR_SIG_NOT_VALID</code>	The I/O signal cannot be accessed. The reasons can be that the I/O device is not running or an error in the configuration (only valid for ICI field bus).

Continues on next page

1 Instructions

1.181 ProcerrRecovery - Generate and recover from process-move error

RobotWare Base

Continued

More examples

More examples of how to use the instruction `ProcerrRecovery` are illustrated below.

Example with `ProcerrRecovery\SyncOrgMoveInst`

```
MODULE user_module
  VAR intnum proc_sup_int;

  PROC main()
    ...
    MoveL p1, v1000, fine, tool1;
    do_process;
    ...
  ENDPROC
  PROC do_process()
    my_proc_on;
    MoveL p2, v200, z10, tool1;
    MoveL p3, v200, fine, tool1;
    my_proc_off;
  ERROR
    IF ERRNO = ERR_PATH_STOP THEN
      my_proc_on;
      StartMove;
      RETRY;
    ENDIF
  ENDPROC

  TRAP iprocfail
    my_proc_off;
    ProcerrRecovery \SyncOrgMoveInst;
  ENDTRAP

  PROC my_proc_on()
    SetDO do_myproc, 1;
    CONNECT proc_sup_int WITH iprocfail;
    ISignalDI di_proc_sup, 1, proc_sup_int;
  ENDPROC

  PROC my_proc_off()
    SetDO do_myproc, 0;
    IDelete proc_sup_int;
  ENDPROC
ENDMODULE
```

Asynchronously raised errors generated by `ProcerrRecovery` with switch `\SyncOrgMoveInst` can, in this example, be treated in the routine `do_process` because the path on which the error occurred is always created in the routine `do_process`.

A process flow is started by setting the signal `do_myproc` to 1. The signal `di_proc_sup` supervise the process, and an asynchronous error is raised if

Continues on next page

1.181 ProcerrRecovery - Generate and recover from process-move error

*RobotWare Base**Continued*

di_proc_sup becomes 1. In this simple example the error is resolved by setting do_myproc to 1 again before resuming the movement.

Example with ProcerrRecovery\SyncLastMoveInst

```

MODULE user_module
  PROC main()
    ...
    MoveL p1, v1000, fine, tool1;
    do_process;
    ...
  ENDPROC
  PROC do_process()
    proc_on;
    proc_move p2, v200, z10, tool1;
    proc_move p3, v200, fine, tool1;
    proc_off;
  ERROR
    IF ERRNO = ERR_PATH_STOP THEN
      StorePath;
      p4 := CRobT(\Tool:=tool1);
      ! Move to service station and fix the problem
      MoveL p4, v200, fine, tool1;
      RestoPath;
      proc_on;
      StartMoveRetry;
    ENDIF
  ENDPROC
ENDMODULE

MODULE proc_module (SYSMODULE, NOSTEPIN)
  VAR intnum proc_sup_int;
  VAR num try_no := 0;

  TRAP iprocfail
    proc_off;
    ProcerrRecovery \SyncLastMoveInst;
  ENDTRAP

  PROC proc_on()
    SetDO do_proc, 1;
    CONNECT proc_sup_int WITH iprocfail;
    ISignalDI di_proc_sup, 1, proc_sup_int;
  ENDPROC

  PROC proc_off()
    SetDO do_proc, 0;
    IDelete proc_sup_int;
  ENDPROC

```

Continues on next page

1 Instructions

1.181 ProcerrRecovery - Generate and recover from process-move error

RobotWare Base

Continued

```
PROC proc_move (robtarget ToPoint, speeddata Speed, zonedata Zone,
  PERS tooldata Tool)
  MoveL ToPoint, Speed, Zone, Tool;
  ERROR
  IF ERRNO = ERR_PATH_STOP THEN
    try_no := try_no + 1;
    IF try_no < 4 THEN
      proc_on;
      StartMoveRetry;
    ELSE
      RaiseToUser \Continue;
    ENDIF
  ENDPROC
ENDMODULE
```

Asynchronously raised errors generated by ProcerrRecovery with switch \SyncLastMoveInst can in this example be treated in the routine proc_move because all move instructions are always created in the routine proc_move. When program pointer is in routine do_process the transfer to ERROR handler will be delayed until running the next MoveL in routine proc_move. Note that the movements are always stopped at once.

A process flow is started by setting the signal do_myproc to 1. The signal di_proc_sup supervise the process, and an asynchronous error is raised if di_proc_sup becomes 1. In this simple example the error is resolved by setting do_myproc to 1 again before resuming the movement.

When using predefined NOSTEPIN routine we recommend using the option switch parameter \SyncLastMoveInst because then the predefined routine can make the decision to handle some error situation within the routine while others must be handled by the end user.

Limitations

Error recovery from asynchronously raised process errors can only be done if the motion task with the process move instruction is executing on base level when the process error occurs. So error recovery cannot be done if the program task with the process instruction executes in:

- any event routine
- any routine handler (ERROR, BACKWARD or UNDO)
- user execution level (service routine)

See *Technical reference manual - RAPID kernel, Error recovery, Asynchronously raised errors*.

If no error handler with a StartMove + RETRY or a StartMoveRetry is used, the program execution will hang. The only way to reset this is to do a PP to main.

Syntax

```
ProcerrRecovery
[ '\ SyncOrgMoveInst ] | [ ' \ SyncLastMoveInst ]
[ '\ ProcSignal' :=' ] < variable (VAR) of signaldo > ';' 
```

Continues on next page

Related information

For information about	See
Error handlers	<i>Technical reference manual - RAPID Overview</i>
Asynchronously raised errors	<i>Technical reference manual - RAPID kernel, Error recover</i>
Propagates an error to user level	<i>RaiseToUser - Propagates an error to user level on page 579</i>
Resume movement and program execution	<i>StartMoveRetry - Restarts robot movement and execution on page 794</i>

1 Instructions

1.182 PrxActivAndStoreRecord - Activate and store the recorded profile data

Machine Synchronization

1.182 PrxActivAndStoreRecord - Activate and store the recorded profile data

Usage

`PrxActivAndStoreRecord` is used to activate the recorded profile data and store it in a file.

Can be used instead of calling both `PrxActivRecord` and `PrxStoreRecord`.

Basic example

```
PrxActivAndStoreRecord SSYNCl, 1, "profile.log";
```

Profile of sensor movement activated and is stored in the file *profile.log*.

Arguments

```
PrxActivAndStoreRecord MechUnit Delay File_name
```

MechUnit

Data type: `mechunit`

The moving mechanical unit object to which the robot movement is synchronized.

Delay

Data type: `num`

The delay in seconds can be used to shift the record in time. It must be between 0.01 and 0.1. If given the value 0 no delay is added. The delay is not saved in the profile, it is just used for the activation. If the delay should be used together with a saved profile the delay has to be specified again in the instruction `PrxUseFileRecord`.

File_name

Data type: `string`

Name of the file where the profile is stored.

Program execution

`PrxActivAndStoreRecord` must be executed at least 0.2 seconds before start of sensor movement if the record is to be used for synchronization.

Error handling

The following recoverable errors can be generated. The errors can be handled in an error handler. The system variable `ERRNO` will be set to:

Name	Cause of error
<code>ERR_ACTIV_PROF</code>	Error in the activated profile.
<code>ERR_STORE_PROF</code>	Error in the stored profile.
<code>ERR_USE_PROF</code>	Error in the used profile.

Syntax

```
PrxActivAndStoreRecord  
  [ MechUnit ':= ' ] < expression (IN) of mechunit > ', '  
  [ Delay ':= ' ] < expression (IN) of num > ', '
```

Continues on next page

1.182 PrxActivAndStoreRecord - Activate and store the recorded profile data

Machine Synchronization
Continued

```
[ File_name ' := ' ] < expression (IN) of string > ' ; '
```

Related information

For information about	See
Activate the recorded profile data	PrxActivRecord - Activate the recorded profile data on page 558
Deactivate a record	PrxDeactRecord - Deactivate a record on page 561
Store the recorded profile data	PrxStoreRecord - Store the recorded profile data on page 570
<i>Machine Synchronization</i>	<i>Application manual - Controller software IRC5</i>

1 Instructions

1.183 PrxActivRecord - Activate the recorded profile data *Machine Synchronization*

1.183 PrxActivRecord - Activate the recorded profile data

Usage

PrxActivRecord is used to activate the record that was just recorded in order to use it without having to save it before.

Basic example

```
PrxActivRecord SSYNCl, 0;  
WaitTime 0.2;  
SetDO do_startstop_machine, 1;  
!Work synchronized with sensor  
...  
SetDO do_startstop_machine, 0;
```

Record of sensor is activated and used for prediction of sensor movement as soon as record is ready.

Arguments

PrxActivRecord MechUnit Delay

MechUnit

Data type: mechunit

The moving mechanical unit object to which the robot movement is synchronized.

Delay

Data type: num

The delay in seconds can be used to shift the record in time. It must be between 0.01 and 0.1. If given the value 0 no delay is added.

Program execution

PrxActivRecord must be executed at least 0.2 seconds before start of conveyor movement.

Error handling

The following recoverable errors can be generated. The errors can be handled in an error handler. The system variable ERRNO will be set to:

Name	Cause of error
ERR_ACTIV_PROF	Error in the activated profile
ERR_STORE_PROF	Error in the stored profile
ERR_USE_PROF	Error in the used profile

Syntax

```
PrxActivRecord  
[ MechUnit ':' '=' ] < expression (IN) of mechunit > ','  
[ Delay ':' '=' ] < expression (IN) of num > ';' ;
```

Continues on next page

1.183 PrxActivRecord - Activate the recorded profile data

Machine Synchronization
Continued

Related information

For information about	See
Activate and store the recorded profile data	PrxActivAndStoreRecord - Activate and store the recorded profile data on page 556
Deactivate a record	PrxDeactRecord - Deactivate a record on page 561
Store the recorded profile data	PrxStoreRecord - Store the recorded profile data on page 570
<i>Machine Synchronization</i>	<i>Application manual - Controller software IRC5</i>

1 Instructions

1.184 PrxDbgStoreRecord - Store and debug the recorded profile data

Machine Synchronization

1.184 PrxDbgStoreRecord - Store and debug the recorded profile data

Usage

PrxDbgStoreRecord is used to store a non activated record for debug.
Can be used to compare recordings and check the repeatability.

Basic example

```
PrxDbgStoreRecord SSYNCl, "debug_profile.log";
```

Saves the recording in the file *debug_profile.log*.

Arguments

```
PrxDbgStoreRecord MechUnit Filename
```

MechUnit

Data type: mechunit

The moving mechanical unit object to which the robot movement is synchronized.

File_name

Data type: string

Name of the file where the record is stored.

Syntax

```
PrxDbgStoreRecord  
[ MechUnit ':= ' ] < expression (IN) of mechunit > ','  
[ File_name ':= ' ] < expression (IN) of string > ';' 
```

Related information

For information about	See
Activate and store the recorded profile data	PrxActivAndStoreRecord - Activate and store the recorded profile data on page 556
Activate the recorded profile data	PrxActivRecord - Activate the recorded profile data on page 558
Store the recorded profile data	PrxStoreRecord - Store the recorded profile data on page 570
<i>Machine Synchronization</i>	<i>Application manual - Controller software IRC5</i>

1.185 PrxDeactRecord - Deactivate a record

Usage

PrxDeactRecord is used to deactivate a record.

Basic example

```
PrxDeactRecord SSYNCl;
```

Record of sensor movement is deactivated and no longer used for prediction of sensor movement. The record can be activated again.

Arguments

```
PrxDeactRecord MechUnit
```

MechUnit

Data type: mechunit

The moving mechanical unit object to which the robot movement is synchronized.

Limitations

PrxDeactRecord should not be called during synchronization.

Syntax

```
PrxDeactRecord  
[ MechUnit ':= ' ] < expression (IN) of mechunit> ';' 
```

Related information

For information about	See
Activate the recorded profile data	PrxActivRecord - Activate the recorded profile data on page 558
<i>Machine Synchronization</i>	<i>Application manual - Controller software IRC5</i>

1 Instructions

1.186 PrxResetPos - Reset the zero position of the sensor

Machine Synchronization

1.186 PrxResetPos - Reset the zero position of the sensor

Usage

`PrxResetPos` is used to reset the zero position of the sensor.

The sensor position is reset for synchronization functionality and recorded file but the I/O signal value is not reset. This instruction is used for software reset of sensor input where no sync switch is available to reset the I/O signal.

Basic example

```
PrxResetPos SSYNCL;
```

The sensor position is set to zero.

Arguments

```
PrxResetPos MechUnit
```

MechUnit

Data type: mechunit

The moving mechanical unit object to which the robot movement is synchronized.

Program execution

The sensor unit must be stopped (in the desired zero position) before calling `PrxResetPos`.

Limitations

Not to be used with the DSQC 377A board.

This instruction is equivalent to a sync switch. Jogging window should show 0.0 as additional axis position after this instruction.

Syntax

```
PrxResetPos  
[ MechUnit ':= ' ] < expression (IN) of mechunit> ';' 
```

Related information

For information about	See
Set a reference position for the sensor	PrxSetPosOffset - Set a reference position for the sensor on page 564
<i>Machine Synchronization</i>	<i>Application manual - Controller software IRC5</i>

1.187 PrxResetRecords - Reset and deactivate all records

Usage

`PrxResetRecords` is used to reset and deactivate all records.

Basic example

```
PrxResetRecords SSYNCl;
```

Record of sensor movement is deactivated and no longer used for prediction of sensor movement and the record data is removed.

Arguments

```
PrxResetRecords MechUnit
```

MechUnit

Data type: mechunit

The moving mechanical unit object to which the robot movement is synchronized.

Program execution

`PrxResetRecords` must be executed at least 0.2 seconds before start of conveyor movement.

Syntax

```
PrxResetRecords  
[ MechUnit ':= ' ] < expression (IN) of mechunit > ';' 
```

Related information

For information about	See
<i>Machine Synchronization</i>	<i>Application manual - Controller software IRC5</i>

1 Instructions

1.188 PrxSetPosOffset - Set a reference position for the sensor

Machine Synchronization

1.188 PrxSetPosOffset - Set a reference position for the sensor

Usage

`PrxSetPosOffset` is used to set a reference position for the sensor.

The sensor position is set to reference for synchronization functionality and recorded file. This function is used for software set of sensor reference where no sync switch is available to reset the I/O signal.

Basic example

```
PrxSetPosOffset SSYNCl, reference;
```

The sensor position is set to the reference value.

Arguments

```
PrxSetPosOffset MechUnit Reference
```

MechUnit

Data type: mechunit

The moving mechanical unit object to which the robot movement is synchronized.

Reference

Data type: num

The reference in meter (or sensor unit). It must be between -5000 and 5000.

Program execution

The sensor unit must be stopped before calling `PrxSetPosOffset`.

Limitations

Not to be used with the DSQC 377A board.

Syntax

```
PrxSetPosOffset  
  [ MechUnit ::= ' ] < expression (IN) of mechunit > ','  
  [ Reference ::= ' ] < expression (IN) of num > ';' 
```

Related information

For information about	See
Reset the zero position of the sensor	PrxResetPos - Reset the zero position of the sensor on page 562
<i>Machine Synchronization</i>	<i>Application manual - Controller software IRC5</i>

1.189 PrxSetRecordSampleTime - Set the sample time for recording a profile

Machine Synchronization

1.189 PrxSetRecordSampleTime - Set the sample time for recording a profile

Usage

`PrxSetRecordSampleTime` is used to set the sample time, in seconds, for recording a profile.

The default sample time is taken from the system parameter *Pos Update time*, belonging to type *CAN interface* in the topic *Process*. Note that *Pos Update time* specifies the sample time in milliseconds, while `PrxSetRecordSampleTime` specifies the sample time in seconds.

The maximum number of samples in a recorded profile is 300. If a recording is longer than $300 * \textit{Pos Update time}$, the sample time must be increased.

Basic example

A 12 second recording is to be made. The sample time cannot be less than $12/300 = 0.04$. The sample time is therefore set to 0.04 seconds.

```
PrxSetRecordSampleTime SSYNC1, 0.04;
```

Arguments

```
PrxSetRecordSampleTime MechUnit SampleTime
```

MechUnit

Data type: mechunit

The moving mechanical unit object to which the robot movement is synchronized.

SampleTime

Data type: num

The sample time in seconds. The sample time must be between 0.01 and 0.1.

Syntax

```
PrxSetRecordSampleTime
  [ MechUnit ':= ' ] < expression (IN) of mechunit> ', '
  [ SampleTime ':= ' ] < expression (IN) of num> ';'

```

Related information

For information about	See
<i>Machine Synchronization</i>	<i>Application manual - Controller software IRC5</i>

1 Instructions

1.190 PrxSetSyncalarm - Set sync alarm behavior

Machine Synchronization

1.190 PrxSetSyncalarm - Set sync alarm behavior

Usage

`PrxSetSyncalarm` is used to set `sync_alarm_signal` behavior to a pulse during specified time.

If sync alarm is triggered, the `Sync_alarm_signal` is pulsed during the time specified by the instruction `PrxSetSyncalarm`. It can also be set to no pulse, that is, the signal continues to be high.

The default pulse length is 1 sec.

Basic examples

Example 1

```
PrxSetSyncalarm SSYNCl \time:=2;
```

Sets the length of the pulse on the `sync_alarm_signal` to 2 seconds.

Example 2

```
PrxSetSyncalarm SSYNCl \NoPulse;
```

If the sync alarm is triggered the `sync_alarm_signal` is set (not pulsed).

Arguments

```
PrxSetSyncalarm MechUnit [\Time] | [\NoPulse]
```

MechUnit

Data type: mechunit

The moving mechanical unit object to which the robot movement is synchronized.

[\Time]

Data type: num

The pulse length in seconds. It must be between 0.1 and 60.

If `\Time` is set to more than 60, no pulse is used (same effect as using `\NoPulse`).

[\NoPulse]

Data type: switch

No pulse is used. The signal is set until a `SupSyncSensorOff` instruction is executed:

Syntax

```
PrxSetSyncalarm  
  [ MechUnit ':= ' ] < expression (IN) of mechunit >  
  [ '\ ' Time ':= ' < expression (IN) of num > ]  
  | [ '\ ' NoPulse ] ';' 
```

Related information

For information about	See
SupSyncSensorOff - Stop synchronized sensor supervision	SupSyncSensorOff - Stop synchronized sensor supervision on page 833
Machine Synchronization	Application manual - Controller software IRC5

1.191 PrxStartRecord - Record a new profile

Usage

PrxStartRecord is used to reset all profile data and record a new profile of the sensor movement as soon as *sensor_start_signal* is set.

To be able to make a recording it is important to first make a connection to a sensor (mechanical unit whose speed affects the speed of the robot). This means that a WaitSensor instruction has to be executed before the recording starts.

Basic example

```
ActUnit SSYNCl;
WaitSensor SSYNCl;
PrxStartRecord SSYNCl, 1, PRX_PROFILE_T1;
WaitTime 0.2;
SetDO do_startstop_machine 1;
```

Signal *do_startstop_machine*, in this example, starts the sensor movement. Profile of the sensor is recorded as soon as the machine sets the signal *sensor_start_signal*.

Arguments

PrxStartRecord MechUnit, Record_duration, Profile_type

MechUnit

Data type: mechunit

The moving mechanical unit object to which the robot movement is synchronized.

Record_duration

Data type: num

Specifies the duration of record in seconds. It must be between 0.1 and *Pos Update time* * 300. If the value 0 is used, the instruction PrxStopRecord must be used to stop the recording.

Profile_type

Data type: num

Possible value and their explanation is listed below:

Value	Description
PRX_INDEX_PROF	Record is started by <i>sensor_start_signal</i> .
PRX_START_ST_PR	A start and stop movement can be recorded. <i>sensor_start_signal</i> is used to record start movement and <i>sensor_stop_signal</i> is used to record stop movement.
PRX_STOP_ST_PROF	Same as for PRX_START_ST_PR only different orders on signals. The <i>sensor_stop_signal</i> is used first.
PRX_STOP_M_PROF	The recording is started by <i>sensor_stop_signal</i> .
PRX_HPRESS_PROF	For recording hydraulic press (where sensor position zero corresponds to the press being open).
PRX_PROFILE_T1	For recording IMM or other machine (where sensor position zero corresponds to the press being closed).

Continues on next page

1 Instructions

1.191 PrxStartRecord - Record a new profile

Machine Synchronization

Continued

Program execution

PrxStartRecord must be executed at least 0.2 seconds before start of sensor movement.

Syntax

```
PrxStartRecord
  [ MechUnit ':= ' ] < expression (IN) of mechunit > ', '
  [ Record_duration ':= ' ] < expression (IN) of num > ', '
  [ Profile_type ':= ' ] < expression (IN) of num > ';'

```

Related information

For information about	See
Stop recording a profile	PrxStopRecord - Stop recording a profile on page 569
<i>Machine Synchronization</i>	<i>Application manual - Controller software IRC5</i>

1.192 PrxStopRecord - Stop recording a profile

Usage

PrxStopRecord is used to stop recording a profile.

Should always be used when PrxStartRecord has Record_duration set to 0.

Basic example

```

ActUnit SSYNCl;
WaitSensor SSYNCl;
PrxStartRecord SSYNCl, 0, PRX_PROFILE_T1;
WaitTime 0.2;
SetDo do_startstop_machine 1;
WaitTime 2;
PrxStopRecord SSYNCl;

```

Signal *do_startstop_machine*, in this example, starts the sensor movement. Profile of sensor movement is recorded as soon as *sensor_start_signal* is set and after two seconds the recording is stopped with the instruction PrxStopRecord.

Arguments

PrxStopRecord MechUnit

MechUnit

Data type: mechunit

The moving mechanical unit object to which the robot movement is synchronized.

Syntax

```

PrxStopRecord
  [ MechUnit ':= ' ] < expression (IN) of mechunit > ';'

```

Related information

For information about	See
Record a new profile	PrxStartRecord - Record a new profile on page 567
Machine Synchronization	Application manual - Controller software IRC5

1 Instructions

1.193 PrxStoreRecord - Store the recorded profile data

Machine Synchronization

1.193 PrxStoreRecord - Store the recorded profile data

Usage

PrxStoreRecord is used to save an activated record in a file.

Basic example

```
ActUnit SSYNCl;  
WaitSensor SSYNCl;  
PrxStartRecord SSYNCl, 0, PRX_PROFILE_T1;  
WaitTime 0.2;  
SetDo do_startstop_machine 1;  
WaitTime 2;  
PrxStopRecord SSYNCl;  
PrxActivRecord SSYNCl;  
SetDo do_startstop_machine 0;  
PrxStoreRecord SSYNCl, 0, "profile.log";
```

Profile of sensor movement is recorded as soon as *sensor_start_signal* is set and is stored in the file *profile.log*.

Arguments

PrxStoreRecord MechUnit Delay Filename

MechUnit

Data type: mechunit

The moving mechanical unit object to which the robot movement is synchronized.

Delay

Data type: num

The delay in seconds can be used to shift the record in time. It must be between 0.01 and 0.1. If given the value 0 no delay is added. The delay is not saved in the profile, it is just used for the activation. If the delay should be used together with a saved profile the delay has to be specified again in the instruction

PrxUseFileRecord.

File_name

Data type: string

Name of the file where the profile is stored.

Limitations

The record must be activated before calling PrxStoreRecord.

Syntax

```
PrxStoreRecord  
[ MechUnit ':= ' ] < expression (IN) of mechunit > ', '  
[ Delay ':= ' ] < expression (IN) of num > ', '  
[ File_name ':= ' ] < expression (IN) of string > ';'
```

Continues on next page

Related information

For information about	See
Activate the recorded profile data	PrxActivRecord - Activate the recorded profile data on page 558
Deactivate a record	PrxDeactRecord - Deactivate a record on page 561
Use the recorded profile data	PrxUseFileRecord - Use the recorded profile data on page 572
<i>Machine Synchronization</i>	<i>Application manual - Controller software IRC5</i>

1 Instructions

1.194 PrxUseFileRecord - Use the recorded profile data

Machine Synchronization

1.194 PrxUseFileRecord - Use the recorded profile data

Usage

PrxUseFileRecord is used to load and activate a record from a file for sensor synchronization.

Basic example

```
PrxUseFileRecord SSYNCl, 0, "profile.log";
WaitTime 0.2;
SetDo do_startstop_machine 1;
!Work synchronized with sensorWork synchronized with sensor
...
SetDo do_startstop_machine 0;
```

Arguments

PrxUseFileRecord MechUnit Delay Filename

MechUnit

Data type: mechunit

The moving mechanical unit object to which the robot movement is synchronized.

Delay

Data type: num

The delay in seconds can be used to shift the record in time. It must be between 0.01 and 0.1. If given the value 0 no delay is added.

File_name

Data type: string

Name of the file where the profile is stored.

Program execution

PrxUseFileRecord must be executed at least 0.2 seconds before start of conveyor movement.

Syntax

```
PrxUseFileRecord
  [ MechUnit ':' ] < expression (IN) of mechunit > ','
  [ Delay ':' ] < expression (IN) of num > ','
  [ File_name ':' ] < expression (IN) of string > ';' ;
```

Related information

For information about	See
Activate the recorded profile data	PrxActivRecord - Activate the recorded profile data on page 558
Deactivate a record	PrxDeactRecord - Deactivate a record on page 561
Store the recorded profile data	PrxStoreRecord - Store the recorded profile data on page 570
Machine Synchronization	Application manual - Controller software IRC5

1.195 PulseDO - Generates a pulse on a digital output signal

Usage

PulseDO is used to generate a pulse on a digital output signal.

Basic examples

The following examples illustrate the instruction `PulseDO`:

Example 1

```
PulseDO do15;
```

A pulse with a pulse length of 0.2 s is generated on the output signal `do15`.

Example 2

```
PulseDO \PLength:=1.0, ignition;
```

A pulse of length 1.0 s is generated on the signal `ignition`.

Example 3

```
! Program task MAIN
PulseDO \High, do3;
! At almost the same time in program task BCK1
PulseDO \High, do3;
```

Positive pulse (value 1) is generated on the signal `do3` from two program tasks at almost the same time. It will result in one positive pulse with a pulse length longer than the default 0.2 s or two positive pulses after each other with a pulse length of 0.2 s.

Arguments

```
PulseDO [ \High ] [ \PLength ] Signal
```

[\High]

High level

Data type: `switch`

Specifies that the signal value should always be set to high (value 1) when the instruction is executed independently of its current state.

[\PLength]

Pulse Length

Data type: `num`

The length of the pulse in seconds (0.001 - 2000 s). If the argument is omitted a 0.2 second pulse is generated.

Signal

Data type: `signaldo`

The name of the signal on which a pulse is to be generated.

Continues on next page

1 Instructions

1.195 PulseDO - Generates a pulse on a digital output signal

RobotWare Base

Continued

Program execution

The next instruction after `PulseDO` is executed directly after the pulse starts. The pulse can then be set/reset without affecting the rest of the program execution.

The figure below shows examples of generation of pulses on a digital output signal.

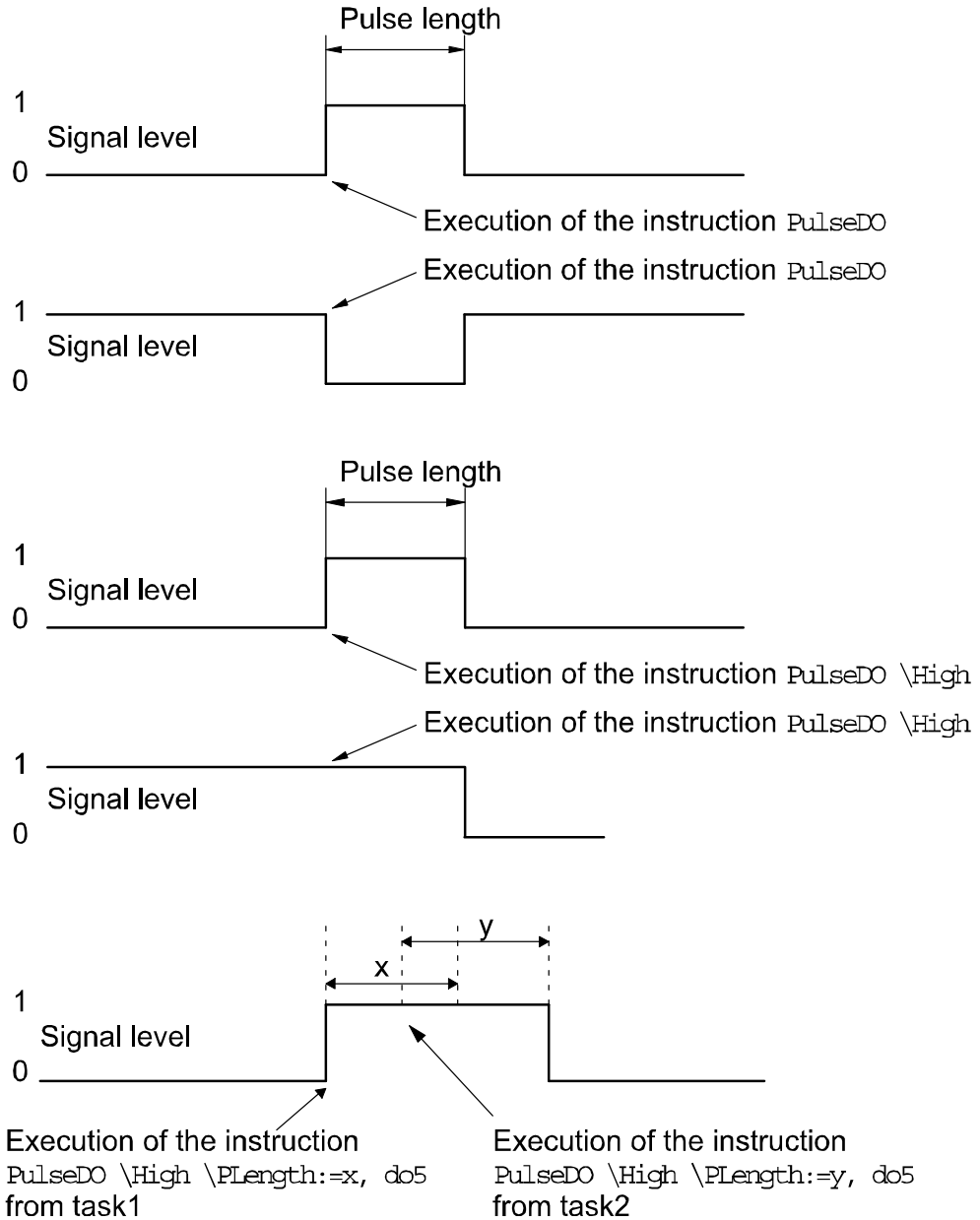

xx0500002217

The next instruction is executed directly after the pulse starts. The pulse can then be set/reset without affecting the rest of the program execution.

Limitations

The length of the pulse has a resolution off 0.001 seconds. Programmed values that differ from this are rounded off.

Continues on next page

Error handling

The following recoverable errors are generated and can be handled in an error handler. The system variable `ERRNO` will be set to:

Name	Cause of error
<code>ERR_NO_ALIASIO_DEF</code>	The signal variable is a variable declared in RAPID. It has not been connected to an I/O signal defined in the I/O configuration with instruction <code>AliasIO</code> .
<code>ERR_NORUNUNIT</code>	There is no contact with the I/O device.
<code>ERR_SIG_NOT_VALID</code>	The I/O signal cannot be accessed. The reasons can be that the I/O device is not running or an error in the configuration (only valid for ICI field bus).

Syntax

```
PulseDO
  ['\' High]
  ['\' PLength ':=<expression (IN) of num>'],'
  [Signal ':='] <variable (VAR) of signaldo>';'
```

Related information

For information about	See
Input/Output instructions	<i>Technical reference manual - RAPID Overview</i>
Input/Output functionality in general	<i>Technical reference manual - RAPID Overview</i>
Configuration of I/O	<i>Technical reference manual - System parameters</i>

1 Instructions

1.196 RAISE - Calls an error handler

RobotWare Base

1.196 RAISE - Calls an error handler

Usage

RAISE is used to create an error in the program and then to call the error handler of the routine.

RAISE can also be used in the error handler to propagate the current error to the error handler of the calling routine.

This instruction can, for example, be used to jump back to a higher level in the structure of the program, e.g. to the error handler in the main routine if an error occurs at a lower level.

Basic examples

The following example illustrates the instruction RAISE:

See also [More examples on page 577](#).

Example 1

```
MODULE MainModule .
VAR errnum ERR_MY_ERR := -1;

PROC main()
  BookErrNo ERR_MY_ERR;

  IF dil = 0 THEN
    RAISE ERR_MY_ERR;
  ENDIF

  ERROR
  IF ERRNO = ERR_MY_ERR THEN
    TPWrite "dil equals 0";
  ENDIF

ENDPROC

ENDMODULE
```

For this implementation `dil equals 0` is regarded as an error. RAISE will force the execution to the error handler. In this example the user has created his own error number to handle the specific error.

Arguments

```
RAISE [ Error no. ]
```

Error no.

Data type: `errnum`

Error number: Any number between 1 and 90 which the error handler can use to locate the error that has occurred (the `ERRNO` system variable).

It is also possible to book an error number outside the range 1-90 with the instruction `BookErrNo`.

Continues on next page

The error number must be specified outside the error handler in a RAISE instruction to transfer execution to the error handler of that routine.

If the instruction is present in a routine's error handler then the error is propagated to the error handler of the calling routine. In this case the error number does not have to be specified.

Program execution

Program execution continues in the routine's error handler. After the error handler has been executed the program execution can continue with:

- the routine that called the routine in question (RETURN).
- the error handler of the routine that called the routine in question (RAISE).

A RAISE instruction in a routine's error handler also has another feature. It can be used for long jump (see "Error Recovery With Long Jump"). With a long jump it is possible to propagate an error from an error handler from a deep nested call chain to a higher level in one step.

If the RAISE instruction is present in a trap routine, the error is dealt with by the system's error handler.

Error handling

The following recoverable errors are generated and can be handled in an error handler. The system variable `ERRNO` will be set to:

Name	Cause of error
<code>ERR_ILLRAISE</code>	Error number in RAISE is out of range.

More examples

More examples of the instruction RAISE are illustrated below.

Example 1

```
MODULE MainModule
VAR num value1 := 10;
VAR num value2 := 0;

PROC main()
  routine1;

  ERROR
  IF ERRNO = ERR_DIVZERO THEN
    value2 := 1;
    RETRY;
  ENDIF
ENDPROC

PROC routine1()
  value1 := 5/value2; !This will lead to an error when value2 is
  equal to 0.
  ERROR
  RAISE;
ENDPROC
```

Continues on next page

1 Instructions

1.196 RAISE - Calls an error handler

RobotWare Base

Continued

ENDMODULE

In this example the division with zero will result in an error. In the `ERROR-handler` `RAISE` will propagate the error to the `ERROR-handler` in the calling routine "main". The same error number remains active. `RETRY` will re-run the whole routine "routine1".

Syntax

```
RAISE [<error number>] ';' ;'
```

Related information

For information about	See
Error handling	<i>Technical reference manual - System parameters</i>
Error recovery with long jump	<i>Technical reference manual - RAPID kernel</i>
Booking error numbers	BookErrNo - Book a RAPID system error number on page 49

1.197 RaiseToUser - Propagates an error to user level

Usage

`RaiseToUser` is used in an error handler in nostepin routines to propagate the current error or any other defined error to the error handler at user level. User level is in this case the first routine in a call chain above a nostepin routine.

Basic examples

The following example illustrates the instruction `RaiseToUser`:

Example 1

```
MODULE MyModule
  VAR errnum ERR_MYDIVZERO:= -1;
  PROC main()
    BookErrNo ERR_MYDIVZERO;
    ...
    routine1;
    ...
    ERROR
    IF ERRNO = ERR_MYDIVZERO THEN
      TRYNEXT;
    ELSE
      RETRY;
    ENDIF
  ENDPROC
ENDMODULE

MODULE MySysModule (SYSMODULE, NOSTEPIN, VIEWONLY)
  PROC routine1()
    ...
    routine2;
    ...
  UNDO
  ! Free allocated resources
  ENDPROC
  PROC routine2()
    VAR num n:=0;
    ...
    reg1:=reg2/n;
    ...
    ERROR
    IF ERRNO = ERR_DIVZERO THEN
      RaiseToUser \Continue \ErrorNumber:=ERR_MYDIVZERO;
    ELSE
      RaiseToUser \BreakOff;
    ENDIF
  ENDPROC
ENDMODULE
```

The division by zero in `routine2` will propagate up to the error handler in `main` routine with the `errno` set to `ERR_MYDIVZERO`. The `TRYNEXT` instruction in `main`

Continues on next page

1 Instructions

1.197 RaiseToUser - Propagates an error to user level

RobotWare Base

Continued

error handler will then cause the program execution to continue with the instruction after the division by zero in `routine2`. The `\Continue` switch controls this behavior.

If any other errors occur in `routine2` then the `\BreakOff` switch forces the execution to continue from the error handler in the main routine. In this case the undo handler in `routine1` will be executed while raising it to user level. The `RETRY` instruction in the error handler in the main routine will execute `routine1` from the beginning once again.

The undo handler in `routine1` will also be executed in the `\Continue` case if a following `RAISE` or `RETURN` is done on the user level.

Arguments

`RaiseToUser` [`\Continue`] | [`\BreakOff`] [`\ErrorNumber`]

[`\Continue`]

Data type: switch

Continue the execution in the routine that caused the error.

[`\BreakOff`]

Data type:switch

Break off the call chain and continue the execution at the user level. Any undo handler in the call chain will be executed apart from the undo handler in the routine that raised the error.

One of the arguments `\Continue` or `\BreakOff` must be programmed to avoid an execution error.

[`\ErrorNumber`]

Data type: errnum

Any number between 1 and 90 that the error handler can use to locate the error that has occurred (the `ERRNO` system variable).

It is also possible to book an error number outside the range 1-90 with the instruction `BookErrNo`.

If the argument `\ErrorNumber` is not specified then the original error number propagates to the error handler in the routine at user level.

Program execution

`RaiseToUser` can only be used in an error handler in a nostepin routine.

The program execution continues in the error handler of the routine at user level. The error number remains active if the optional parameter `\ErrorNumber` is not present. The system error handler deals with the error if there is no error handler on user level. The system error handler is called if none of the arguments `\Continue` or `\BreakOff` are specified.

There are two different behaviors after the error handler has been executed. The program execution continues in the routine with `RaiseToUser` if the `\Continue` switch is on. The program execution continues at the user level if the `\BreakOff` switch is on.

Continues on next page

Program execution can continue with:

- the instruction that caused the error (`RETRY`)
- the following instruction (`TRYNEXT`)
- the error handler of the routine that called the routine at user level (`RAISE`)
- the routine that called the routine at user level (`RETURN`)

Error handling

The following recoverable errors are generated and can be handled in an error handler. The system variable `ERRNO` will be set to:

Name	Cause of error
<code>ERR_ILLRAISE</code>	Error number in <code>RAISE</code> is out of range.

Syntax

```

RaiseToUser
  [ '\ ' Continue ]
  '| ' [ '\ ' BreakOff ]
  [ '\ ' ErrorNumber ':=' ] < expression (IN) of errnum> ';'
    
```

Related information

For information about	See
Error handling	<i>Technical reference manual - RAPID Overview</i>
Undo handling	<i>Technical reference manual - RAPID Overview</i>
Booking error numbers	BookErrNo - Book a RAPID system error number on page 49

1 Instructions

1.198 ReadAnyBin - Read data from a binary I/O device or file

RobotWare Base

1.198 ReadAnyBin - Read data from a binary I/O device or file

Usage

`ReadAnyBin` (*Read Any Binary*) is used to read any type of data from a binary I/O device or file.

Basic examples

The following example illustrates the instruction `ReadAnyBin`:

Example 1

```
VAR iodev file1;
VAR robtargt next_target;
...
Open "HOME:" \File:= "bin_file.txt", file1 \Read \Bin;
ReadAnyBin file1, next_target;
```

The next robot target to be executed, `next_target`, is read from the file `file1`.

Arguments

```
ReadAnyBin IODevice Data [\Time]
```

IODevice

Data type: `iodev`

The name (reference) of the binary I/O device or file to be read.

Data

Data type: `anytype`

The VAR or PERS to which the read data will be stored.

[\Time]

Data type: `num`

The max. time for the reading operation (timeout) in seconds. If this argument is not specified then the max. time is set to 60 seconds. To wait forever, use the predefined constant `WAIT_MAX`.

If this time runs out before the read operation is finished then the error handler will be called with the error code `ERR_DEV_MAXTIME`. If there is no error handler then the execution will be stopped.

The timeout function is also in use during program stop and will be noticed by the RAPID program at program start.

Program execution

As many bytes as are required for the specified data are read from the specified binary I/O device or file.

At power fail restart, any open file or I/O device in the system will be closed and the I/O descriptor in the variable of type `iodev` will be reset.

Continues on next page

Error handling

The following recoverable errors are generated and can be handled in an error handler. The system variable `ERRNO` will be set to:

Name	Cause of error
<code>ERR_FILEACC</code>	The path points to a non-existing directory or there are too many directories open at the same time.
<code>ERR_DEV_MAXTIME</code>	Timeout when executing a <code>ReadBin</code> , <code>ReadNum</code> , <code>ReadStr</code> , <code>ReadStrBin</code> , <code>ReadAnyBin</code> , or a <code>ReadRawBytes</code> instruction.
<code>ERR_RANYBIN_CHK</code>	Check sum error detected at data transfer with instruction <code>ReadAnyBin</code> .
<code>ERR_RANYBIN_EOF</code>	End of file is detected before all bytes are read in instruction <code>ReadAnyBin</code> .

Limitations

This instruction can only be used for I/O devices or files that have been opened for binary reading.

The data to be read by this instruction `ReadAnyBin` must be a value data type such as `num`, `bool`, or `string`. Record, record component, array, or array element of these value data types can also be used. Entire data or partial data with semi-value or non-value data types cannot be used.



Note

The `VAR` or `PERS` variable, for storage of the read data, can be updated in several steps. Therefore, always wait until the whole data structure is updated before using read data from a trap routine or another program task.

Because `WriteAnyBin-ReadAnyBin` are designed to only handle internal binary controller data with I/O device or files between or within the robot controller, no data protocol is released and the data cannot be interpreted on any PC.

Control software development can break the compatibility, and therefore it might not be possible to use `WriteAnyBin-ReadAnyBin` between different software versions of RobotWare.

Syntax

```
ReadAnyBin
  [IODevice ':='] <variable (VAR) of iodev> ','
  [Data ':='] <var or pers (INOUT) of anytype>
  ['\ ' Time ':='] <expression (IN) of num> ';' ;'
```

Related information

For information about	See
Opening of I/O devices or files	<i>Technical reference manual - RAPID Overview</i>
Write data to a binary I/O device or file	WriteAnyBin - Writes data to a binary file or I/O device on page 1098
File and I/O device handling	<i>Application manual - Controller software IRC5</i>

1 Instructions

1.199 ReadBlock - read a block of data from device

Sensor Interface

1.199 ReadBlock - read a block of data from device

Usage

ReadBlock is used to read a block of data from a device connected to the serial sensor interface. *The data is stored in a file.*

The sensor interface communicates with two sensors over serial channels using the RTP1 transport protocol.

This is an example of a sensor channel configuration.

COM_PHY_CHANNEL:

- Name "COM1:"
- Connector "COM1"
- Baudrate 19200

COM_TRP:

- Name "sen1:"
- Type "RTP1"
- PhyChannel "COM1"

Basic examples

The following example illustrates the instruction ReadBlock:

Example 1

```
CONST string SensorPar := "flp1:senpar.cfg";
CONST num ParBlock:= 1;

! Connect to the sensor device "sen1:" (defined in sio.cfg).
SenDevice "sen1:";

! Read sensor parameters from sensor datablock 1
! and store on flp1:senpar.cfg

ReadBlock "sen1:", ParBlock, SensorPar;
```

Arguments

```
ReadBlock device BlockNo FileName [ \TaskName ]
```

device

Data type: string

The I/O device name configured in sio.cfg for the sensor used.

BlockNo

Data type: num

The argument BlockNo is used to select the data block in the sensor to be read.

FileName

Data type: string

The argument FileName is used to define a file to which data is written from the data block in the sensor selected by the BlockNo argument.

Continues on next page

[\TaskName]

Data type: string

The argument `TaskName` makes it possible to access devices in other RAPID tasks.

Error handling

Error constant (ERRNO value)	Description
SEN_NO_MEAS	Measurement failure
SEN_NOREADY	Sensor unable to handle command
SEN_GENERRO	General sensor error
SEN_BUSY	Sensor busy
SEN_UNKNOWN	Unknown sensor
SEN_EXALARM	External sensor error
SEN_CAALARM	Internal sensor error
SEN_TEMP	Sensor temperature error
SEN_VALUE	Illegal communication value
SEN_CAMCHECK	Sensor check failure
SEN_TIMEOUT	Communication error

Syntax

```

ReadBlock
  [ device ':= ' ] < expression(IN) of string > ', '
  [ BlockNo ':= ' ] < expression (IN) of num > ', '
  [ FileName ':= ' ] < expression (IN) of string > ', '
  [ '\ ' TaskName ':= ' < expression (IN) of string > ] ';'
    
```

Related information

For information about	See
Connect to a sensor device	SenDevice - connect to a sensor device on page 688
Write a sensor variable	WriteVar - Write variable on page 1112
Read a sensor variable	ReadVar - Read variable from a device on page 1440
Write a sensor data block	WriteBlock - Write block of data to device on page 1102
Configuration of sensor communication	<i>Technical reference manual - System parameters</i>

1 Instructions

1.200 ReadCfgData - Reads attribute of a system parameter

RobotWare Base

1.200 ReadCfgData - Reads attribute of a system parameter

Usage

`ReadCfgData` is used to read one attribute of a system parameter (configuration data).

Besides to reading named parameters it is also possible to search for unnamed parameters.

Basic examples

The following example illustrates the instruction `ReadCfgData`. Both of these examples show how to read named parameters.

Example 1

```
VAR num offset1;  
...  
ReadCfgData "/MOC/MOTOR_CALIB/rob1_1", "cal_offset", offset1;
```

Reads the value of the calibration offset for axis 1 for `rob_1` into the `num` variable `offset1`.

Example 2

```
VAR string io_device;  
...  
ReadCfgData "/EIO/EIO_SIGNAL/process_error", "Device", io_device;
```

Reads the name of the I/O device where the signal `process_error` is defined into the `string` variable `io_device`.

Arguments

```
ReadCfgData InstancePath Attribute CfgData [\ListNo]
```

InstancePath

Data type: string

Specifies a path to the parameter to be accessed.

For named parameters the format of this string is `/DOMAIN/TYPE/ParameterName`.

For unnamed parameters the format of this string is

`/DOMAIN/TYPE/Attribute/AttributeValue`.

Attribute

Data type: string

The name of the attribute of the parameter to be read.

CfgData

Data type: anytype

The variable where the attribute value will be stored. Depending on the attribute type the valid types are `bool`, `num`, `dnum`, or `string`.

[\ListNo]

Data type: num

Continues on next page

Variable holding the instance number of the `Attribute + AttributeValue` to be found.

First occurrence of the `Attribute + AttributeValue` has an instance number 0. If more instances are searched for then the returned value in `\ListNo` will be incremented with 1. Otherwise, if there are no more instances then the returned value will be -1. The predefined constant `END_OF_LIST` can be used to check if more instances are to be search for.

Program execution

The value of the attribute specified by the `Attribute` argument is stored in the variable specified by the `CfgData` argument.

If using format `/DOMAIN/TYPE/ParameterName` in `InstancePath`, only named parameters can be accessed, i.e. parameters where the first attribute is `name`, `Name`, or `NAME`.

For unnamed parameters use the optional parameter `\ListNo` to selects from which instance to read the attribute value. It is updated after each successful read to the next available instance.

Predefined data

The predefined constant `END_OF_LIST` with value -1 can be used to stop reading when no more instances can be found.

Error handling

The following recoverable errors are generated and can be handled in an error handler. The system variable `ERRNO` will be set to:

Name	Cause of error
<code>ERR_CFG_NOTFND</code>	It is not possible to find the data specified with "InstancePath + Attribute" in the configuration database.
<code>ERR_CFG_ILLLTYPE</code>	The data type for parameter <code>CfgData</code> is not equal to the real data type for the found data specified with "InstancePath + Attribute" in the configuration database.
<code>ERR_CFG_INTERNAL</code>	Not allowed to read internal parameter
<code>ERR_CFG_OUTOFBOUNDS</code>	The variable in argument <code>\ListNo</code> has a value outside range of available instances (0 ... n) when executing the instruction.

More examples

More examples of the instruction `ReadCfgdata` are illustrated below. Both these examples show how to read unnamed parameters.

Example 1

```
VAR num list_index;
VAR string read_str;
...
list_index:=0;
```

Continues on next page

1 Instructions

1.200 ReadCfgData - Reads attribute of a system parameter

RobotWare Base

Continued

```
ReadCfgData "/EIO/EIO_CROSS/Act1/do_13", "Res", read_str,
  \ListNo:=list_index;
IF read_str <> "" THEN
  TPWrite "Resultant signal for signal do_13 is: " + read_str;
ENDIF
```

Reads the resultant signal for the unnamed digital actor signal di_13 and places the name in the string variable read_str.

In this example domain EIO has the following cfg code:

EIO_CROSS:

-Name "Cross_di_1_do_2" -Res "di_1" -Act1 "do_2"

-Name "Cross_di_2_do_2" -Res "di_2" -Act1 "do_2"

-Name "Cross_di_13_do_13" -Res "di_13" -Act1 "do_13"

Example 2

```
VAR num list_index;
VAR string read_str;
...
list_index:=0;
WHILE list_index <> END_OF_LIST DO
  read_str:="";
  ReadCfgData "/EIO/EIO_SIGNAL/Device/USERIO", "Name", read_str,
    \ListNo:=list_index;
  IF read_str <> "" THEN
    TPWrite "Signal: " + read_str;
  ENDIF
ENDWHILE
..
ERROR
  TRYNEXT;
```

Read the names of all signals defined for the I/O device USERIO.

In this example domain EIO has the following cfg code:

```
EIO_SIGNAL:
  -Name "USERDO1" -SignalType "DO" -Device "USERIO" -DeviceMap "0"
  -Name "USERDO2" -SignalType "DO" -Device "USERIO" -DeviceMap "1"
  -Name "USERDO3" -SignalType "DO" -Device "USERIO" -DeviceMap "2"
```

Example 3

```
VAR num list_index;
VAR string read_str;
...
list_index:=0;
WHILE list_index <> END_OF_LIST DO
  read_str:="";
  ReadCfgData "/EIO/DEVICENET_DEVICE/Network/DeviceNet", "Name",
    read_str, \ListNo:=list_index;
  IF read_str <> "" THEN
    TPWrite read_str;
  ENDIF
ENDWHILE
..
```

Continues on next page

```
ERROR
  TRYNEXT;
```

Read the names of all DeviceNet devices.

In this example domain EIO has the following cfg code:

```
DEVICENET_DEVICE:
  -Name PANEL -Network "DeviceNet" -Simulated
  -Name DRV_1 -Network "DeviceNet" -Simulated
  -Name DEVICE1 -Network "DeviceNet" -Simulated
  -Name DEVICE2 -Network "DeviceNet" -Simulated
```

Limitations

The conversion from system parameter units (m, radian, second, and so on.) to RAPID program units (mm, degree, second, and so on.) for CfgData of data type num and dnum must be done by the user in the RAPID program.

If using format /DOMAIN/TYPE/ParameterName in InstancePath then only named parameters can be accessed, i.e. parameters where the first attribute is name, Name, or NAME.

RAPID strings are limited to 80 characters. In some cases this can be in theory too small for the definition InstancePath, Attribute or CfgData.

Syntax

```
ReadCfgData
  [ InstancePath ':= ' ] < expression (IN) of string > ','
  [ Attribute ':= ' ] < expression (IN) of string > ','
  [ CfgData ':= ' ] < variable (VAR) of anytype >
  [ '\ ' ListNo ':= ' < variable (VAR) of num > ] ';' ;'
```

Related information

For information about	See
Definition of string	string - Strings on page 1761
Write attribute of a system parameter	WriteCfgData - Writes attribute of a system parameter on page 1104
Get robot name in current task	RobName - Get the TCP robot name on page 1447
Configuration	Technical reference manual - System parameters
Advanced RAPID	Application manual - Controller software IRC5

1 Instructions

1.201 ReadErrData - Gets information about an error

RobotWare Base

1.201 ReadErrData - Gets information about an error

Usage

`ReadErrData` is to be used in a trap routine, to get information (domain, type, number and intermixed strings %s) about an error, a state change, or a warning that caused the trap routine to be executed.

Basic examples

The following example illustrates the instruction `ReadErrData`:

See chapter [More examples on page 591](#).

Example 1

```
VAR errdomain err_domain;
VAR num err_number;
VAR errtype err_type;
VAR trapdata err_data;
VAR string titlestr;
VAR string string1;
VAR string string2;
...
TRAP trap_err
  GetTrapData err_data;
  ReadErrData err_data, err_domain, err_number,
  err_type \Title:=titlestr \Str1:=string1 \Str2:=string2;
ENDTRAP
```

When an error is trapped to the trap routine `trap_err` the error domain, the error number, the error type, and the two first intermixed strings in the error message are saved into appropriate variables.

Arguments

```
ReadErrData TrapEvent ErrorDomain ErrorId ErrorType [\Title] [\Str1]
[\Str2] [\Str3] [\Str4] [\Str5]
```

TrapEvent

Data type: `trapdata`

Variable containing the information about what caused the trap to be executed.

ErrorDomain

Data type: `errdomain`

Variable to store the error domain to which the error, state change, or warning that occurred belongs. Ref. to predefined data of type `errdomain`.

ErrorId

Data type: `num`

Variable to store the number of the error that occurred. The error number is returned without the first digit (error domain) and without the initial zeros of the complete error number.

E.g. 10008 Program restarted is returned as 8.

Continues on next page

ErrorType

Data type: errrtype

Variable to store the type of event such as error, state change, or warning that occurred. Ref. to predefined data of type errrtype.

[\Title]

Data type: string

Variable to store the title in the error message. The title is in UTF8 format and all characters will not be displayed correctly for all languages on the FlexPendant.

[\Str1] ... [\Str5]

Data type: string

Update the specified string variable with argument that is intermixed in the error message. There could be up to five arguments in a message of type %s, %f, %d or %ld, which always will be converted to a string at execution of this instruction. Str1 will hold the first argument, Str2 will hold the second argument, and so on. Information about how many arguments there are in a message is found in *Operating manual - Trouble shooting*. The intermixed arguments is marked as arg in that document.

Program execution

The ErrorDomain, ErrorId, ErrorType, Title and Str1 ... Str5 variables are updated according to the contents of TrapEvent.

If different events are connected to the same trap routine then the program must ensure that the event is related to error monitoring. This can be done by testing that INTNO matches the interrupt number used in the instruction IError;

More examples

More examples of the instruction ReadErrData are illustrated below.

Example 1

```
VAR intnum err_interrupt;  
VAR trapdata err_data;  
VAR errdomain err_domain;  
VAR num err_number;  
VAR errrtype err_type;  
...  
PROC main()  
  CONNECT err_interrupt WITH trap_err;  
  IError COMMON_ERR, TYPE_ERR, err_interrupt;  
  ...  
  IDelete err_interrupt;  
  ...  
TRAP trap_err  
  GetTrapData err_data;  
  ReadErrData err_data, err_domain, err_number, err_type;  
  ! Set domain no 1 ... 11  
  SetGO go_err1, err_domain;  
  ! Set error no 1 ...9999
```

Continues on next page

1 Instructions

1.201 ReadErrData - Gets information about an error

RobotWare Base

Continued

```
SetGO go_err2, err_number;  
ENDTRAP
```

When an error occurs (only errors, not warning or state change) the error number is retrieved in the trap routine and its value is used to set 2 groups of digital output signals.

Limitation

It is not possible obtain information about internal errors.

Syntax

```
ReadErrData  
[TrapEvent ':='] <variable (VAR) of trapdata>', '  
[ErrorDomain ':='] <variable (VAR) of errdomain>', '  
[ErrorId ':='] <variable (VAR) of num>', '  
[ErrorType ':='] <variable (VAR) of errtype>  
['\Title ':='] <variable (VAR) of string>  
['\Str1 ':='] <variable (VAR) of string>  
['\Str2 ':='] <variable (VAR) of string>  
['\Str3 ':='] <variable (VAR) of string>  
['\Str4 ':='] <variable (VAR) of string>  
['\Str5 ':='] <variable (VAR) of string>]';
```

Related information

For information about	See
Summary of interrupts	<i>Technical reference manual - RAPID Overview</i>
More information on interrupt management	<i>Technical reference manual - RAPID Overview</i>
Error domains, predefined constants	errdomain - Error domain on page 1651
Error types, predefined constants	errtype - Error type on page 1662
Orders an interrupt on errors	IError - Orders an interrupt on errors on page 255
Get interrupt data for current trap	GetTrapData - Get interrupt data for current trap routine on page 239
<i>Advanced RAPID</i>	<i>Application manual - Controller software IRC5</i>

1.202 ReadRawBytes - Read rawbytes data

Usage

`ReadRawBytes` is used to read data of type `rawbytes` from a device opened with `Open \Bin`.

Basic examples

The following example illustrates the instruction `ReadRawBytes`:

Example 1

```
VAR iODEV io_device;
VAR rawbytes raw_data_out;
VAR rawbytes raw_data_in;
VAR num float := 0.2;
VAR string answer;

ClearRawBytes raw_data_out;
PackDNHeader "10", "20 1D 24 01 30 64", raw_data_out;
PackRawBytes float, raw_data_out, (RawBytesLen(raw_data_out)+1)
    \Float4;

Open "/FC1:/dsqc328_1", io_device \Bin;
WriteRawBytes io_device, raw_data_out;
ReadRawBytes io_device, raw_data_in \Time:=1;
Close io_device;
UnpackRawBytes raw_data_in, 1, answer \ASCII:=10;
```

In this example `raw_data_out` is cleared and then packed with DeviceNet header and a float with value 0.2.

A device, `"/FC1:/dsqc328_1"`, is opened and the current valid data in `raw_data_out` is written to the device. Then the program waits for at most 1 second to read from the device, which is stored in the `raw_data_in`.

After having closed the device `"/FC1:/dsqc328_1"`, the read data is unpacked as a string of characters and stored in `answer`.

Arguments

`ReadRawBytes IODEV RawData [\Time]`

`IODEV`

Data type: `iODEV`

`IODEV` is the identifier of the device from which data shall be read.

`RawData`

Data type: `rawbytes`

`RawData` is the data container that stores read data from `IODEV` starting at index 1.

`[\Time]`

Data type: `num`

Continues on next page

1 Instructions

1.202 ReadRawBytes - Read rawbytes data

RobotWare Base

Continued

The max. time for the reading operation (timeout) in seconds (resolution 0,001s). If this argument is not specified then the max. time is set to 60 seconds. To wait forever, use the predefined constant `WAIT_MAX`.

If this time runs out before the reading operation is finished then the error handler will be called with the error code `ERR_DEV_MAXTIME`. If there is no error handler then the execution will be stopped.

The timeout function is also in use during program stop and will be noticed by the RAPID program at program start.

Program execution

During program execution the data is read from the device indicated by `IIODevice`. If using `WriteRawBytes` for field bus commands such as DeviceNet then the field bus always sends an answer. The answer must be handled in RAPID with the `ReadRawBytes` instruction.

The current length of valid bytes in the `RawData` variable is set to the read number of bytes. The data starts at index 1 in `RawData`.

At power fail restart, any open file or I/O device in the system will be closed and the I/O descriptor in the variable of type `iodev` will be reset.

Error handling

The following recoverable errors are generated and can be handled in an error handler. The system variable `ERRNO` will be set to:

Name	Cause of error
<code>ERR_FILEACC</code>	A file is accessed incorrectly
<code>ERR_DEV_MAXTIME</code>	Time-out when executing the instruction.
<code>ERR_RANYBIN_EOF</code>	End of file is detected before all bytes are read in instruction <code>ReadRawBytes</code> .

Syntax

```
ReadRawBytes
  [ IIODevice ' := ' ] < variable (VAR) of iodev> ' , '
  [ RawData ' := ' ] < variable (VAR) of rawbytes> ' , '
  [ '\ ' Time ' := ' < expression (IN) of num> ] ' ; '
```

Related information

For information about	See
rawbytes data	rawbytes - Raw data on page 1721
Get the length of rawbytes data	RawBytesLen - Get the length of rawbytes data on page 1422
Clear the contents of rawbytes data	ClearRawBytes - Clear the contents of rawbytes data on page 145
Copy the contents of rawbytes data	CopyRawBytes - Copy the contents of rawbytes data on page 169
Pack DeviceNet header into rawbytes data	PackDNHeader - Pack DeviceNet Header into rawbytes data on page 505

Continues on next page

For information about	See
Pack data into <code>rawbytes</code> data	PackRawBytes - Pack data into rawbytes data on page 508
Write <code>rawbytes</code> data	WriteRawBytes - Write rawbytes data on page 1108
Unpack data from <code>rawbytes</code> data	UnpackRawBytes - Unpack data from rawbytes data on page 1013
File and I/O device handling	<i>Application manual - Controller software IRC5</i>

1 Instructions

1.203 ReadVarArr - Read multiple variables from a sensor device

Sensor Interface

1.203 ReadVarArr - Read multiple variables from a sensor device

Usage

`ReadVarArr` is used to read up to six variables at the same time from a sensor device. The result is from the same sample.

The sensor must be configured and communicating via the RobotWare option *Sensor Interface*.

Basic examples

The following example illustrates the instruction `ReadVarArr`.

Example 1

```
CONST num xcoord := 8;
CONST num ycoord := 9;
CONST num zcoord := 10;
VAR pos sensorpos;
VAR sensorvardata readdata{4};

! Connect to the sensor device "sen1:" (defined in sio.cfg).
SenDevice "sen1:";

! Read a cartesian position from the sensor.
readdata{1} := [xcoord, 2, false, 1, 0];
readdata{2} := [ycoord, 2, false, 1, 0];
readdata{3} := [zcoord, 2, false, 1, 0];
! A varNumber of -1 will be ignored
readdata{4} := [-1, 2, false, 1, 0];

ReadVarArr "sen1", readdata;
sensorpos.x := DnumToNum(readdata{1}.value);
sensorpos.y := DnumToNum(readdata{2}.value);
sensorpos.z := DnumToNum(readdata{3}.value);
```

The example shows a reading of three variables at the same time. The reading is done at the same time and is from the same sample from the sensor.

Arguments

`ReadVarArr Device, Data, [\TaskName]`

Device

Data type: string

The I/O device name configured in `sio.cfg` for the sensor used.

Data

Data type: sensorvardata

An array variable that refers to a data definition of the variables to be read. The result value of the reading is also returned within this definition.

[\TaskName]

Data type: string

Continues on next page

The argument `TaskName` makes it possible to access devices in other RAPID tasks.

Error handling

The following recoverable errors are generated and can be handled in an error handler. The system variable `ERRNO` will be set to:

Name	Cause of error
SEN_NO_MEAS	Measurement failure
SEN_NOREADY	Sensor unable to handle command
SEN_GENERRO	General sensor error
SEN_BUSY	Sensor busy
SEN_UNKNOWN	Unknown sensor
SEN_EXALARM	External sensor error
SEN_CAALARM	Internal sensor error
SEN_TEMP	Sensor temperature error
SEN_VALUE	Illegal communication value
SEN_CAMCHECK	Sensor check failure
SEN_TIMEOUT	Communication error

Syntax

```
ReadVarArr
  [Device ':='] <expression(IN) of string>', '
  [Data ':='] <array variable {*} (INOUT) of sensorvardata>', '
  ['\ ' TaskName ':=' <expression (IN) of string>'];'
```

Related information

For information about	See
Connect to a sensor device	SenDevice - connect to a sensor device on page 688
Write multiple variables to a device	WriteVarArr - Write multiple variables to a sensor device on page 1114
Write a sensor variable	WriteVar - Write variable on page 1112
Read a sensor variable	ReadVar - Read variable from a device on page 1440
Write a sensor data block	WriteBlock - Write block of data to device on page 1102
Read a sensor data block	ReadBlock - read a block of data from device on page 584
Multiple variable setup data for sensor interface	sensorvardata - Multiple variable setup data for sensor interface on page 1741
Configuration of sensor communication	Technical reference manual - RAPID Overview

1 Instructions

1.204 RemoveAllCyclicBool - Remove all Cyclic bool conditions

RobotWare Base

1.204 RemoveAllCyclicBool - Remove all Cyclic bool conditions

Usage

`RemoveAllCyclicBool` is used to remove the cyclic evaluation of all Cyclic bool conditions in the task executing the instruction.

Basic examples

The following example illustrates the instruction `RemoveAllCyclicBool`.

Example 1

```
PERS bool cyclicflag1;
TASK PERS bool cyclicflag2;
PERS bool mypersbool:=FALSE;

PROC main()
  SetupCyclicBool cyclicflag1, di1=1 AND do2=1;
  SetupCyclicBool cyclicflag2, di3 AND di4 AND mypersbool=FALSE;
  ...
  RemoveAllCyclicBool;
  ...
```

First two cyclic evaluations are setup, then later on both are removed.

Example 2

```
PERS bool cyclicflag1;

PROC main()
  SetupCyclicBool cyclicflag1, di1=1 AND do2=1;
  ...
  RemoveAllCyclicBool;
UNDO
  RemoveAllCyclicBool;
ENDPROC
```

All cyclic evaluations are removed when the program pointer is set to main.

The same behavior can be configured in the system parameters without using an UNDO handler, see *Technical reference manual - System parameters*.

Arguments

`RemoveAllCyclicBool` [`\AllTasks`]

[`\AllTasks`]

Data type: switch

This argument is used to remove the cyclic evaluation for all tasks.

Program execution

The behavior of the Cyclic bool functionality can be configured. For more information see *Application manual - Controller software IRC5* and *Technical reference manual - System parameters*.

Continues on next page

Syntax

```
RemoveAllCyclicBool  
  ['\AllTasks] ';' 
```

Related information

For information about	See
Setup a Cyclic bool condition	SetupCyclicBool - Setup a Cyclic bool condition on page 715
Remove a Cyclic bool condition	RemoveCyclicBool - Remove a Cyclic bool condition on page 600
Cyclically evaluated logical conditions, <i>Cyclic bool</i>	<i>Application manual - Controller software IRC5</i>
Configuring <i>Cyclic bool</i>	<i>Technical reference manual - System parameters</i>

1 Instructions

1.205 RemoveCyclicBool - Remove a Cyclic bool condition *RobotWare Base*

1.205 RemoveCyclicBool - Remove a Cyclic bool condition

Usage

`RemoveCyclicBool` is used to remove the cyclic evaluation of a Cyclic bool condition.

Basic examples

The following examples illustrates the instruction `RemoveCyclicBool`.

Example 1

```
PERS bool cyclicflag1;

PROC main()
  SetupCyclicBool cyclicflag1, dil=1 AND do2=1;
  ...
  RemoveCyclicBool cyclicflag1;
  ...
```

First a cyclic evaluation is setup, then later on it is removed.

Example 2

```
PERS bool cyclicflag1;

PROC main()
  SetupCyclicBool cyclicflag1, dil=1 AND do2=1;
  ...
  RemoveCyclicBool "cyclicflag1";
  ...
```

First a cyclic evaluation is setup, then later on it is removed by using the name of the persistent boolean variable.

Arguments

`RemoveCyclicBool` Flag | Name

Flag

Data type: `bool`

The persistent boolean variable that stores the value of the logical condition.

Name

Data type: `string`

The name of the persistent boolean variable that stores the value of the logical condition.

Program execution

The behavior of the Cyclic bool functionality can be configured. For more information see *Application manual - Controller software IRC5* and *Technical reference manual - System parameters*.

Continues on next page

Syntax

```
RemoveCyclicBool
  [ Flag ':= ' ] <persistent (PERS) of bool>
  | [ Name ':= ' ] <expression (IN) of string> ';'

```

Related information

For information about	See
Check if a persistent variable is a Cyclic bool	IsCyclicBool - Checks if a persistent variable is a Cyclic bool on page 1340
Setup a Cyclic bool condition	SetupCyclicBool - Setup a Cyclic bool condition on page 715
Remove all Cyclic bool conditions	RemoveAllCyclicBool - Remove all Cyclic bool conditions on page 598
Cyclically evaluated logical conditions, Cyclic bool	<i>Application manual - Controller software IRC5</i>
Configuring Cyclic bool	<i>Technical reference manual - System parameters</i>

1 Instructions

1.206 RemoveDir - Delete a directory *RobotWare Base*

1.206 RemoveDir - Delete a directory

Usage

`RemoveDir` is used to remove a directory.

The user must have write and execute permission for the directory and the directory must be empty.

Basic examples

The following example illustrates the instruction `RemoveDir`:

Example 1

```
RemoveDir "HOME:/mydir";
```

In this example the `mydir` directory under `HOME:` is deleted.

Arguments

`RemoveDir Path`

Path

Data type: `string`

The name of the directory to be removed, specified with full or relative path.

Error handling

The following recoverable errors are generated and can be handled in an error handler. The system variable `ERRNO` will be set to:

Name	Cause of error
<code>ERR_FILEACC</code>	The directory does not exist, or the directory is not empty, or the user does not have write and execute permission to the library.

Syntax

```
RemoveDir  
[ Path':=' ] < expression (IN) of string>';'
```

Related information

For information about	See
Directory	dir - File directory structure on page 1648
Open a directory	OpenDir - Open a directory on page 503
Read a directory	ReadDir - Read next entry in a directory on page 1426
Close a directory	CloseDir - Close a directory on page 152
Make a directory	MakeDir - Create a new directory on page 353
Rename a file	RenameFile - Rename a file on page 607
Remove a file	RemoveFile - Delete a file on page 604
Copy a file	CopyFile - Copy a file on page 167
Check file type	IsFile - Check the type of a file on page 1343

Continues on next page

For information about	See
Check file size	FileSize - Retrieve the size of a file on page 1274
Check file system size	FSSize - Retrieve the size of a file system on page 1280
File and I/O device handling	Application manual - Controller software IRC5

1 Instructions

1.207 RemoveFile - Delete a file

RobotWare Base

1.207 RemoveFile - Delete a file

Usage

`RemoveFile` is used to remove a file. The user must have write and execute permission for the directory where the file resides and the user must have write permission for the file itself.

Basic examples

The following example illustrates the instruction `RemoveFile`:

Example 1

```
RemoveFile "HOME:/mydir/myfile.log";
```

In this example the file `myfile.log` in directory `mydir` on disk `HOME:` is deleted.

Arguments

`RemoveFile Path`

Path

Data type: string

The name of the file to be deleted, specified with full or relative path.

Error handling

The following recoverable errors are generated and can be handled in an error handler. The system variable `ERRNO` will be set to:

Name	Cause of error
<code>ERR_FILEACC</code>	A file is accessed incorrectly.

Syntax

```
RemoveFile  
[ Path':=' ] < expression (IN) of string>';'
```

Related information

For information about	See
Make a directory	MakeDir - Create a new directory on page 353
Remove a directory	RemoveDir - Delete a directory on page 602
Rename a file	RenameFile - Rename a file on page 607
Copy a file	CopyFile - Copy a file on page 167
Check file type	IsFile - Check the type of a file on page 1343
Check file size	FileSize - Retrieve the size of a file on page 1274
Check file system size	FSSize - Retrieve the size of a file system on page 1280
File and I/O device handling	Application manual - Controller software IRC5

1.208 RemoveSuperv - Remove condition for one signal

Usage

RemoveSuperv is used to remove conditions added by SetupSuperv from supervision.

Basic example

```
PROC main()
  InitSuperv;
  SetupSuperv diWR_EST, ACT, SUPERV_MAIN \ErrIndSig:= do_WR_Sup;
  SetupSuperv diGA_EST, ACT, SUPERV_MAIN;
  CapL p2, v100, cdata1, weavestart, weave,fine, tWeldGun;
  RemoveSuperv di_Arc_Sup, ACT, SUPERV_START;
ENDPROC
```

Removes the signal *di_Arc_Sup* from the START list.

Arguments

RemoveSuperv Signal Condition Listtype

Signal

Data type: signaldi

Digital signal to remove from supervision list.

Condition

Data type: num

The name representing one of the following available conditions:

ACT:	Used for status supervision. Expected signal status during supervision: active. If the signal becomes passive, supervision triggers.
PAS:	Used for status supervision. Expected signal status during supervision: passive. If the signal becomes active, supervision triggers.
POS_EDGE:	Used for handshake supervision. Expected signal status at the end of supervision: active. If the signal does not become active within the chosen timeout, supervision triggers.
NEG_EDGE:	Used for handshake supervision. Expected signal status at the end of supervision: passive. If the signal does not become passive within the chosen timeout, supervision triggers.

Listtype

Data type: num

The name representing the number of the different lists (for example, phases in the process):

- SUPERV_PRE
- SUPERV_PRE_START
- SUPERV_END_PRE
- SUPERV_START
- SUPERV_MAIN
- SUPERV_END_MAIN

Continues on next page

1 Instructions

1.208 RemoveSuperv - Remove condition for one signal

Continuous Application Platform (CAP)

Continued

- SUPERV_START_POST1
- SUPERV_POST1
- SUPERV_END_POST1
- SUPERV_START_POST2
- SUPERV_POST2
- SUPERV_END_POST2

Syntax

RemoveSuperv

[Signal ':='] < variable (**VAR**) of signaldi > ','

[Condition ':='] < variable (**IN**) of num > ','

[Listtype ':='] < variable (**IN**) of num > ';' ;

Related information

For information about	See
<i>Continuous Application Platform</i>	<i>Application manual - Continuous Application Platform</i>
InitSuperv instruction	InitSuperv - Reset all supervision for CAP on page 282
SetupSuperv instruction	SetupSuperv - Setup conditions for signal supervision in CAP on page 718

1.209 RenameFile - Rename a file

Usage

`RenameFile` is used to give a new name to an existing file. It can also be used to move a file from one place to another in the directory structure.

Basic examples

The following example illustrates the instruction `RenameFile`:

Example 1

```
RenameFile "HOME:/myfile", "HOME:/yourfile";
```

The file `myfile` is given the name `yourfile`.

```
RenameFile "HOME:/myfile", "HOME:/mydir/yourfile";
```

The file `myfile` is given the name `yourfile` and is moved to the directory `mydir`.

Arguments

```
RenameFile OldPath NewPath
```

OldPath

Data type:string

The complete path of the file to be renamed.

NewPath

Data type:string

The complete path of the renamed file.

Program execution

The file specified in `OldPath` will be given the name specified in `NewPath`. If the path in `NewPath` is different from the path in `OldPath` then the file will also be moved to the new location.

Error Handling

The following recoverable errors are generated and can be handled in an error handler. The system variable `ERRNO` will be set to:

Name	Cause of error
<code>ERR_FILEACC</code>	The file specified in <code>OldPath</code> does not exist.
<code>ERR_FILEEXIST</code>	The file specified in <code>NewPath</code> already exists.

Syntax

```
RenameFile
[ OldPath' :=' ] < expression (IN) of string > ','
[ NewPath' :=' ] < expression (IN) of string > ';'
```

Related information

For information about	See
Make a directory	MakeDir - Create a new directory on page 353

Continues on next page

1 Instructions

1.209 RenameFile - Rename a file

RobotWare Base

Continued

For information about	See
Remove a directory	RemoveDir - Delete a directory on page 602
Remove a file	RemoveFile - Delete a file on page 604
Copy a file	CopyFile - Copy a file on page 167
Check file type	IsFile - Check the type of a file on page 1343
Check file size	FileSize - Retrieve the size of a file on page 1274
Check file system size	FSSize - Retrieve the size of a file system on page 1280
File and I/O device handling	Application manual - Controller software IRC5

1.210 Reset - Resets a digital output signal

Usage

`Reset` is used to reset the value of a digital output signal to zero.

Basic examples

The following examples illustrate the instruction `Reset`:

Example 1

```
Reset do15;
```

The signal `do15` is set to 0.

Example 2

```
Reset weld;
```

The signal `weld` is set to 0.

Arguments

`Reset Signal`

Signal

Data type: `signaldo`

The name of the signal to be reset to zero.

Program execution

The true value depends on the configuration of the signal. If the signal is inverted in the system parameters then this instruction causes the physical channel to be set to 1.

Error handling

The following recoverable errors are generated and can be handled in an error handler. The system variable `ERRNO` will be set to:

Name	Cause of error
<code>ERR_NO_ALIASIO_DEF</code>	The signal variable is a variable declared in RAPID. It has not been connected to an I/O signal defined in the I/O configuration with instruction <code>AliasIO</code> .
<code>ERR_NORUNUNIT</code>	There is no contact with the I/O device.
<code>ERR_SIG_NOT_VALID</code>	The I/O signal cannot be accessed. The reasons can be that the I/O device is not running or an error in the configuration (only valid for ICI field bus).

Syntax

```
Reset
  [Signal '[:=' ] <variable (VAR) of signaldo>'];'
```

Related information

For information about	See
Setting a digital output signal	Set - Sets a digital output signal on page 690

Continues on next page

1 Instructions

1.210 Reset - Resets a digital output signal

RobotWare Base

Continued

For information about	See
Input/Output instructions	<i>Technical reference manual - RAPID Overview</i>
Input/Output functionality in general	<i>Technical reference manual - RAPID Overview</i>
Configuration of I/O	<i>Technical reference manual - System parameters</i>

1.211 ResetAxisDistance - Reset the traversed distance information for the axis

RobotWare Base

1.211 ResetAxisDistance - Reset the traversed distance information for the axis

Usage

`ResetAxisDistance` is used to reset the traversed distance information for the axis.

Basic examples

The following examples illustrate the instruction `ResetAxisDistance`.

Example 1

```
ResetAxisDistance Track,1;
```

The traversed distance information for axis 1 on mechanical unit `Track` will be reset.

Example 2

```
PERS dnum distanceLimit := 1000;

PROC main()
  IF GetAxisDistance(Track,1) > distanceLimit THEN
    ErrWrite \I, "Distance counter limit reached", "Distance counter
      limit for Track has been reached.";
    DoMaintenance();
  ENDIF
ENDPROC

PROC DoMaintenance()
  ...
  ResetAxisDistance Track, 1;
  ErrWrite \I, "Distance counter reset", "Distance counter for
    Track has been reset.";
ENDPROC
```

The example describes how `ResetAxisDistance` can be used together with `GetAxisDistance` to check if it is time for maintenance of an axis.

Arguments

```
ResetAxisDistance MechUnit AxisNo
```

`MechUnit`

Mechanical Unit

Data type: `mecunit`

The name of the mechanical unit.

`AxisNo`

Data type: `num`

The number of the axis for which the traversed distance is to be reset.

Program execution

Resets the traversed distance information for the selected axis.

Continues on next page

1 Instructions

1.211 ResetAxisDistance - Reset the traversed distance information for the axis

RobotWare Base

Continued

Syntax

```
ResetAxisDistance  
  [MechUnit ':='] < variable (VAR) of mecunit > ','  
  [AxisNo ':='] < variable (VAR) of num > ';' ;
```

Related information

For information about	See
ResetAxisMoveTime	ResetAxisMoveTime - Reset the move time counter of the axis on page 613
GetAxisDistance	GetAxisDistance - Get the traversed distance counter of the axis on page 1283
GetAxisMoveTime	GetAxisMoveTime - Get the move time counter of the axis on page 1285

1.212 ResetAxisMoveTime - Reset the move time counter of the axis

Usage

`ResetAxisMoveTime` is used to reset the move time information for the axis.

Basic examples

The following examples illustrate the instruction `ResetAxisMoveTime`.

Example 1

```
ResetAxisMoveTime Track,1;
```

The move time information for axis 1 on mechanical unit `Track` will be reset.

Example 2

```
PERS dnum timeLimit := 1000;

PROC main()
  IF GetAxisMoveTime(Track,1) > timeLimit THEN
    ErrWrite \I, "Time counter limit reached", "Time counter limit
      for Track has been reached.";
    DoMaintenance();
  ENDIF
ENDPROC

PROC DoMaintenance()
  ...
  ResetAxisMoveTime Track, 1;
  ErrWrite \I, "Time counter reset", "Time counter for Track has
    been reset.";
ENDPROC
```

The example describes how `ResetAxisMoveTime` can be used together with `GetAxisMoveTime` to check if it is time for maintenance of an axis.

Arguments

```
ResetAxisMoveTime MechUnit AxisNo
```

MechUnit

Mechanical Unit

Data type: mecunit

The name of the mechanical unit.

AxisNo

Data type: num

The number of the axis for which the move time is to be reset.

Program execution

Resets the move time information for the selected axis.

Continues on next page

1 Instructions

1.212 ResetAxisMoveTime - Reset the move time counter of the axis

RobotWare Base

Continued

Syntax

```
ResetAxisMoveTime  
  [MechUnit ':='] < variable (VAR) of mecunit > ','  
  [AxisNo ':='] < variable (VAR) of num > ';' 
```

Related information

For information about	See
ResetAxisDistance	ResetAxisDistance - Reset the traversed distance information for the axis on page 611
GetAxisDistance	GetAxisDistance - Get the traversed distance counter of the axis on page 1283
GetAxisMoveTime	GetAxisMoveTime - Get the move time counter of the axis on page 1285

1.213 ResetPPMoved - Reset state for the program pointer moved in manual mode

RobotWare Base

1.213 ResetPPMoved - Reset state for the program pointer moved in manual mode

Usage

`ResetPPMoved` reset state for the program pointer moved in manual mode. `PPMovedInManMode` returns TRUE if the user has moved the program pointer while the controller is in manual mode - that is, the operator key is at Man Reduced Speed or Man Full Speed. The program pointer moved state is reset when the key is switched from Auto to Man, or when using the instruction `ResetPPMoved`.

Basic examples

The following example illustrates the instruction `ResetPPMoved`:

Example 1

```
IF PPMovedInManMode() THEN
  WarnUserOfPPMovement;
  ! DO THIS ONLY ONCE
  ResetPPMoved;
  DoJob;
ELSE
  DoJob;
ENDIF
```

Program execution

Resets state for the program pointer moved in manual mode for current program task.

Syntax

```
ResetPPMoved';'
```

Related information

For information about	See
Test whether program pointer has been moved in manual mode	PPMovedInManMode - Test whether the program pointer is moved in manual mode on page 1415

1 Instructions

1.214 ResetRetryCount - Reset the number of retries

RobotWare Base

1.214 ResetRetryCount - Reset the number of retries

Usage

`ResetRetryCount` is used to reset the number of retries that has been done from an error handler. The maximum number of retries that can be done is defined in the configuration.

Basic examples

The following example illustrates the instruction `ResetRetryCount`:

Example 1

```
VAR num myretries := 0;
...
ERROR
  IF myretries > 2 THEN
    ResetRetryCount;
    myretries := 0;
    TRYNEXT;
  ENDIF
  myretries:= myretries + 1;
  RETRY;
...
```

This program will retry the faulty instruction 3 times and then try the next instruction. The internal system retry counter is reset before trying the next instruction (even if this is done by the system at `TRYNEXT`).

Program execution

For every `RETRY` made from an error handler an internal system counter will check that the maximum number of retries, specified in the configuration, isn't exceeded. Executing the instruction `ResetRetryCount` will reset the counter and make it possible to redo a maximum number of retries again.

Syntax

```
ResetRetryCount ';' ;'
```

Related information

For information about	See
Error handlers	<i>Technical reference manual - RAPID Overview</i>
Resume execution after an error	RETRY - Resume execution after an error on page 620
Configure maximum number of retries	<i>Technical reference manual - System parameters</i>
Number of remaining retries	RemainingRetries - Remaining retries left to do on page 1444

1.215 ResetTorqueMargin - Reset least torque margin

Usage

ResetTorqueMargin is used to reset the least torque margin to be able to start a new measurement.

Basic examples

The following example illustrates the instruction ResetTorqueMargin.

Example 1

```
ResetTorqueMargin \AxisNo:=3;  
! starts a new measurement for axis 3;
```

Arguments

```
ResetTorqueMargin [ \MecUnit ] [ \AxisNo ]
```

[\MecUnit]

Data type: mecunit

The name of the mechanical unit for which an axis is to be reset. If this argument is omitted, the axis for the connected robot is reset.

[\AxisNo]

Data type: num

The number of the axis to be reset (1–6).

If no axis is specified, all axes for the mechanical unit are reset.

Error handling

The following recoverable errors are generated and can be handled in an error handler. The system variable ERRNO will be set to:

ERR_AXIS_PAR	Parameter axis in function is wrong.
--------------	--------------------------------------

Syntax

```
ResetTorqueMargin '('  
  [ '\\' MechUnit ':= ' ] < variable (VAR) of mecunit > ','  
  [ '\\' AxisNo ':= ' < expression (IN) of num > ] ')'
```

Related information

For information about	See
Get torque margin	GetTorqueMargin - Reads the least torque margin on page 1313

1 Instructions

1.216 RestoPath - Restores the path after an interrupt *RobotWare Base*

1.216 RestoPath - Restores the path after an interrupt

Usage

`RestoPath` is used to restore a path that was stored at a previous stage using the instruction `StorePath`.

This instruction can only be used in the main task `T_ROB1` or, if in a `MultiMove` system, in `Motion` tasks.

Basic examples

The following example illustrates the instruction `RestoPath`:

See also *More examples* below.

Example 1

```
RestoPath;
```

Restores the path that was stored earlier using `StorePath`.

Program execution

The current movement path of the robot and the external axes are deleted and the path stored earlier using `StorePath` is restored. Note that nothing moves until the instruction `StartMove` is executed or a return is made using `RETRY` from an error handler.

More examples

More examples of how to use the instruction `RestoPath` are illustrated below.

Example 1

```
ArcL p100, v100, seam1, weld5 \Weave:=weave1, z10, gun1;
...
ERROR
  IF ERRNO=AW_WELD_ERR THEN
    gun_cleaning;
    StartMoveRetry;
  ENDIF
...
PROC gun_cleaning()
  VAR robtarg p1;
  StorePath;
  p1 := CRobT();
  MoveL pclean, v100, fine, gun1;
  ...
  MoveL p1, v100, fine, gun1;
  RestoPath;
ENDPROC
```

In the event of a welding error the program execution continues in the error handler of the routine which in turn calls `gun_cleaning`. The movement path being executed at the time is then stored and the robot moves to the position `pclean` where the error is rectified. When this has been done, the robot returns to the position where the error occurred, `p1`, and stores the original movement once

Continues on next page

again. The weld then automatically restarts, meaning that the robot is first reversed along the path before welding starts and ordinary program execution can continue.

Limitations

Only the movement path data is stored with the instruction `StorePath`. If the user wants to order movements on the new path level then the actual stop position must be stored directly after `StorePath` and before `RestoPath` make a movement to the stored stop position on the path.

If this instruction is preceded by a move instruction then that move instruction must be programmed with a stop point (zonedata `fine`), not a fly-by point, otherwise restart after power failure will not be possible.

`RestoPath` cannot be executed in a RAPID routine connected to any of following special system events: `PowerOn`, `Stop`, `QStop`, `Restart` or `Step`.

Syntax

```
RestoPath';'
```

Related information

For information about	See
Storing paths	StorePath - Stores the path when an interrupt occurs on page 826
More examples	StorePath - Stores the path when an interrupt occurs on page 826 PathRecStart - Start the path recorder on page 531 SyncMoveSuspend - Set independent-semicoordinated movements on page 850

1 Instructions

1.217 RETRY - Resume execution after an error

RobotWare Base

1.217 RETRY - Resume execution after an error

Usage

The `RETRY` instruction is used to resume program execution after an error starting with (re-executing) the instruction that caused the error.

Basic examples

The following example illustrates the instruction `RETRY`:

Example 1

```
reg2 := reg3/reg4;  
...  
ERROR  
  IF ERRNO = ERR_DIVZERO THEN  
    reg4 :=1;  
    RETRY;  
  ENDIF
```

An attempt is made to divide `reg3` by `reg4`. If `reg4` is equal to 0 (division by zero) then a jump is made to the error handler, which initializes `reg4`. The `RETRY` instruction is then used to jump from the error handler and another attempt is made to complete the division.

Program execution

Program execution continues with (re-executes) the instruction that caused the error.

Error handling

If the maximum number of retries (4 retries) is exceeded then the program execution stops with an error message. The maximum number of retries can be configured in System Parameters (type *General RAPID*).

Limitations

The instruction can only exist in a routine's error handler. If the error was created using a `RAISE` instruction then program execution cannot be restarted with a `RETRY` instruction. Then the instruction `TRYNEXT` should be used.

Syntax

```
RETRY ';' ;'
```

Related information

For information about	See
Error handlers	<i>Technical reference manual - RAPID Overview</i>
Configure maximum number of retries	<i>Technical reference manual - System parameters</i>
Continue with the next instruction	TRYNEXT - Jumps over an instruction which has caused an error on page 983

1.218 RETURN - Finishes execution of a routine

Usage

`RETURN` is used to finish the execution of a routine. If the routine is a function then the function value is also returned.

Basic examples

The following examples illustrate the instruction `RETURN`:

Example 1

```
errormessage;  
Set do1;  
...  
PROC errormessage()  
  IF dil=1 THEN  
    RETURN;  
  ENDIF  
  TPWrite "Error";  
ENDPROC
```

The `errormessage` procedure is called. If the procedure arrives at the `RETURN` instruction then program execution returns to the instruction following the procedure call, `Set do 1`.

Example 2

```
FUNC num abs_value(num value)  
  IF value<0 THEN  
    RETURN -value;  
  ELSE  
    RETURN value;  
  ENDIF  
ENDFUNC
```

The function returns the absolute value of a number.

Arguments

```
RETURN [ Return value ]
```

Return value

Data type: According to the function declaration.

The return value of a function.

The return value must be specified in a `RETURN` instruction present in a function.

If the instruction is present in a procedure or trap routine then a return value shall not be specified.

Continues on next page

1 Instructions

1.218 RETURN - Finishes execution of a routine

RobotWare Base

Continued

Program execution

The result of the `RETURN` instruction may vary depending on the type of routine it is used in:

- **Main routine:** If a program has run mode single cycle then the program stops. Otherwise, program execution continues with the first instruction of the main routine.
 - **Procedure:** Program execution continues with the instruction following the procedure call.
 - **Function:** Returns the value of the function.
 - **Trap routine:** Program execution continues from where the interrupt occurred.
 - **Error handler in a procedure:** Program execution continues with the routine that called the routine with the error handler (with the instruction following the procedure call).
 - **Error handler in a function:** The function value is returned.
-

Syntax

```
RETURN [ <expression> ]';'
```

Related information

For information about	See
Functions and Procedures	<i>Technical reference manual - RAPID Overview</i>
Trap routines	<i>Technical reference manual - RAPID Overview</i>
Error handlers	<i>Technical reference manual - RAPID Overview</i>

1.219 Rewind - Rewind file position

Usage

`Rewind` sets the file position to the beginning of the file.

Basic examples

The following example illustrates the instruction `Rewind`:

Example 1

```
Rewind iodev1;
```

The file referred to by `iodev1` will have the file position set to the beginning of the file.

Arguments

`Rewind IODevice`

IODevice

Data type: `iodev`

Name (reference) of the file to be rewound.

Program execution

The specified file is rewound to the beginning.

At power fail restart, any open file or I/O device in the system will be closed and the I/O descriptor in the variable of type `iodev` will be reset.

Error handling

The following recoverable errors are generated and can be handled in an error handler. The system variable `ERRNO` will be set to:

Name	Cause of error
<code>ERR_FILEACC</code>	A file is accessed incorrectly.

Limitations

If the used file has been opened with a `\Bin` or `\Bin \Append` switch, a `Rewind` before any type of a `Write` instruction will be ineffective. The writing will be done at the end of the file.

Syntax

```
Rewind [IODevice '[:='] <variable (VAR) of iodev>'];'
```

Related information

For information about	See
Opening, etc. of files	<i>Technical reference manual - RAPID Overview</i>
File and I/O device handling	<i>Application manual - Controller software IRC5</i>

1 Instructions

1.220 RMQEmptyQueue - Empty RAPID Message Queue *FlexPendant Interface, PC Interface, or Multitasking*

1.220 RMQEmptyQueue - Empty RAPID Message Queue

Usage

`RMQEmptyQueue` empties the RAPID Message Queue (RMQ) in the task that is executing the instruction.

Basic examples

The following example illustrates the instruction `RMQEmptyQueue`:

Example

```
RMQEmptyQueue;
```

The `RMQEmptyQueue` instruction removes all messages from RMQ in the executing task.

Program execution

The RAPID Message Queue owned by the executing task is emptied. The instruction can be used on all execution levels.

Limitations

`RMQEmptyQueue` only empties the RAPID Message Queue in the task that is executing the instruction. All other RAPID Message Queues are left as is.

Syntax

```
RMQEmptyQueue ';' ;'
```

Related information

For information about	See
Description of the RAPID Message Queue functionality	<i>Application manual - Controller software IRC5</i> , section <i>RAPID Message Queue</i> .
<code>rmqmessage</code> data type	rmqmessage - RAPID Message Queue message on page 1731 .
Send data to the queue of a RAPID task	RMQSendMessage - Send an RMQ data message on page 640 .
Send data to the queue of a RAPID task and wait for an answer from the client	RMQSendWait - Send an RMQ data message and wait for a response on page 644 .
Find the identity number of a RAPID Message Queue task	RMQFindSlot - Find a slot identity from the slot name on page 626 .
Extract the header data from an <code>rmqmessage</code>	RMQGetMsgHeader - Get header information from an RMQ message on page 634 .
Extract the data from an <code>rmqmessage</code>	RMQGetMsgData - Get the data part from an RMQ message on page 631 .
Order and enable interrupts for a specific data type	IRMQMessage - Orders RMQ interrupts for a data type on page 301 .
Get the slot name from a specified slot identity	RMQGetSlotName - Get the name of an RMQ client on page 1445 .

Continues on next page

1.220 RMQEmptyQueue - Empty RAPID Message Queue *FlexPendant Interface, PC Interface, or Multitasking* *Continued*

For information about	See
Receive message from RMQ	RMQReadWait - Returns message from RMQ on page 637.
Get the first message from a RAPID Message Queue	RMQGetMessage - Get an RMQ message on page 628.

1 Instructions

1.221 RMQFindSlot - Find a slot identity from the slot name *FlexPendant Interface, PC Interface, or Multitasking*

1.221 RMQFindSlot - Find a slot identity from the slot name

Usage

`RMQFindSlot` (*RAPID Message Queue Find Slot*) is used to find the slot identity to an RMQ configured for a RAPID task, or the slot identity to a Robot Application Builder client.

Basic examples

The following example illustrates the instruction `RMQFindSlot`:

Example 1

```
VAR rmqslot myrmqslot;  
RMQFindSlot myrmqslot, "RMQ_T_ROB2";
```

Get the identity number for the RMQ "RMQ_T_ROB2" configured for the RAPID task "T_ROB2".

Arguments

`RMQFindSlot Slot Name`

Slot

Data type: `rmqslot`

The variable in which the numeric identifier is returned.

Name

Data type: `string`

The name of the client to find the identity number for. The name must be right regarding small and big letters. If the RAPID task is named T_ROB1, and using the name `RMQ_t_rob1` for the RMQ, this will end up in a error (see error handling chapter below.)

Program execution

The `RMQFindSlot` instruction is used to find the slot identity for a named RMQ or Robot Application Builder client.

Error handling

The following recoverable errors are generated and can be handled in an error handler. The system variable `ERRNO` will be set to:

Name	Cause of error
<code>ERR_RMQ_NAME</code>	The given slot name is not valid or not found.

Syntax

```
RMQFindSlot  
[ Slot ':' ] < variable (VAR) of rmqslot > ','  
[ Name ':' ] < expression (IN) of string > ';' ;
```

Continues on next page

1.221 RMQFindSlot - Find a slot identity from the slot name
FlexPendant Interface, PC Interface, or Multitasking
Continued

Related information

For information about	See
Description of the RAPID Message Queue functionality	<i>Application manual - Controller software IRC5, section RAPID Message Queue.</i>
Send data to the queue of a RAPID task	RMQSendMessage - Send an RMQ data message on page 640
Get the first message from a RAPID Message Queue.	RMQGetMessage - Get an RMQ message on page 628
Send data to the queue of a RAPID task and wait for an answer from the client	RMQSendWait - Send an RMQ data message and wait for a response on page 644
Extract the header data from a <code>rmqmessage</code>	RMQGetMsgHeader - Get header information from an RMQ message on page 634
Order and enable interrupts for a specific data type	IRMQMessage - Orders RMQ interrupts for a data type on page 301
Extract the data from a <code>rmqmessage</code>	RMQGetMsgData - Get the data part from an RMQ message on page 631
Get the slot name from a specified slot identity	RMQGetSlotName - Get the name of an RMQ client on page 1445
RMQ Slot	rmqslot - Identity number of an RMQ client on page 1732

1 Instructions

1.222 RMQGetMessage - Get an RMQ message *FlexPendant Interface, PC Interface, or Multitasking*

1.222 RMQGetMessage - Get an RMQ message

Usage

`RMQGetMessage` (*RAPID Message Queue Get Message*) is used to fetch the first RMQ message from the queue for the actual program task.

Basic examples

The following example illustrates the instruction `RMQGetMessage`:

See also [More examples on page 629](#).

Example 1

```
TRAP msghandler
  VAR rmqmessage myrmqmsg;
  RMQGetMessage myrmqmsg;
  . . .
ENDTRAP
```

In the trap routine `msghandler` the `rmqmessage` is fetched from the RMQ and copied to the variable `myrmqmsg`.

Arguments

`RMQGetMessage Message`

Message

Data type: `rmqmessage`

Variable for storage of the RMQ message.

The maximum size of the data that can be received in a `rmqmessage` is about 3000 bytes.

Program execution

The instruction `RMQGetMessage` is used to get the first message from the queue of the task executing the instruction. If there is a message, it will be copied to the `Message` variable, and then removed from the queue to make room for new messages. The instruction is only supported on the trap level.

Error handling

The following recoverable errors are generated and can be handled in an error handler. The system variable `ERRNO` will be set to:

Name	Cause of error
<code>ERR_RMQ_NOMSG</code>	There is no message in the queue at the moment. If executing <code>RMQGetMessage</code> twice in a trap routine, this can happen. The error can also be generated if there is a power failure between the trap routine being ordered and the instruction <code>RMQGetMessage</code> being executed. The messages in the RMQ will be lost at power fail.
<code>ERR_RMQ_INVMSG</code>	Invalid message, likely sent from other client than a RAPID task. This may for instance happen if a PC application sends a corrupt message.

Continues on next page

More examples

More examples of how to use the instruction `RMQGetMessage` are illustrated below.

Example 1

```
RECORD mydatatype
  int x;
  int y;
ENDRECORD

VAR intnum msgreceive;
VAR mydatatype mydata;

PROC main()
  ! Setup interrupt
  CONNECT msgreceive WITH msghandler;
  ! Order cyclic interrupt to occur for data type mydatatype
  IRMQMessage mydata, msgreceive;
  WHILE TRUE DO
    ! Performing cycle
    ...
  ENDWHILE
ENDPROC

TRAP msghandler
  VAR rmqmessage message;
  VAR rmqheader header;

  ! Get the RMQ message
  RMQGetMessage message;
  ! Copy RMQ header information
  RMQGetMsgHeader message \Header:=header;

  IF header.datatype = "mydatatype" AND header.ndim = 0 THEN
    ! Copy the data from the message
    RMQGetMsgData message, mydata;
  ELSE
    TPWrite "Received a type not handled or with wrong dimension";
  ENDIF
ENDTRAP
```

When a new message is received, the trap routine `msghandler` is executed and the new message is copied to the variable `message` (instruction `RMQGetMessage`). Then the RMQ header data is copied (instruction `RMQGetMsgHeader`). If the message is of the expected data type and has the right dimension, the data is copied to the variable `mydata` (instruction `RMQGetMsgData`).

Limitations

`RMQGetMessage` is not supported on the user execution level (i.e. in service routines) or normal execution level.

Continues on next page

1 Instructions

1.222 RMQGetMessage - Get an RMQ message *FlexPendant Interface, PC Interface, or Multitasking* *Continued*

The maximum size of the data that can be received in a `rmqmessage` is about 3000 bytes.

A recommendation is to reuse a variable of the data type `rmqmessage` as much as possible to save RAPID memory.

Syntax

```
RMQGetMessage  
  [ Message ':= ' ] < variable (VAR) of rmqmessage > ';' ;
```

Related information

For information about	See
Description of the RAPID Message Queue functionality	Application manual - Controller software IRC5, section RAPID Message Queue.
Find the identity number of a RAPID Message Queue task	RMQFindSlot - Find a slot identity from the slot name on page 626
Send data to the queue of a RAPID task	RMQSendMessage - Send an RMQ data message on page 640
Send data to the queue of a RAPID task and wait for an answer from the client	RMQSendWait - Send an RMQ data message and wait for a response on page 644
Extract the header data from an <code>rmqmessage</code>	RMQGetMsgHeader - Get header information from an RMQ message on page 634
Extract the data from an <code>rmqmessage</code>	RMQGetMsgData - Get the data part from an RMQ message on page 631
Order and enable interrupts for a specific data type	IRMQMessage - Orders RMQ interrupts for a data type on page 301
Get the slot name from a specified slot identity	RMQGetSlotName - Get the name of an RMQ client on page 1445
RMQ Message	rmqmessage - RAPID Message Queue message on page 1731

1.223 RMQGetMsgData - Get the data part from an RMQ message *FlexPendant Interface, PC Interface, or Multitasking*

1.223 RMQGetMsgData - Get the data part from an RMQ message

Usage

`RMQGetMsgData` (*RAPID Message Queue Get Message Data*) is used to get the actual data within the RMQ message.

Basic examples

The following example illustrates the instruction `RMQGetMsgData`:

See also [RMQGetMsgData - Get the data part from an RMQ message on page 631](#).

Example 1

```
VAR rmqmessage myrmqmsg;
VAR num data;
...
RMQGetMsgData myrmqmsg, data;
! Handle data
```

Data of the data type `num` is fetched from the variable `myrmqmsg` and stored in the variable `data`.

Arguments

`RMQGetMsgData` Message Data

Message

Data type: `rmqmessage`

Variable containing the received RMQ message.

Data

Data type: `anytype`

Variable of the expected data type, used for storage of the received data.

Program execution

The instruction `RMQGetMsgData` is used to get the actual data within the RMQ message, convert it to binary data, compile the data to see if it is possible to store it in the variable specified in the instruction, and then copy it to the variable.

Error handling

The following recoverable errors are generated and can be handled in an error handler. The system variable `ERRNO` will be set to:

Name	Cause of error
<code>ERR_RMQ_VALUE</code>	The received message and the data type used in argument <code>Data</code> does not have the same data type.
<code>ERR_RMQ_DIM</code>	The data types are equal, but the dimensions differ between the data in the message and the variable used in argument <code>Data</code> .
<code>ERR_RMQ_MSGSIZE</code>	The size of the received data is bigger than the maximum configured size for the RMQ for the receiving task.
<code>ERR_RMQ_INVMSG</code>	This error will be thrown if the message is invalid. This may for instance happen if a PC application sends a corrupt message.

Continues on next page

1 Instructions

1.223 RMQGetMsgData - Get the data part from an RMQ message

FlexPendant Interface, PC Interface, or Multitasking

Continued

More examples

More examples of how to use the instruction `RMQGetMsgData` are illustrated below.

Example 1

```
RECORD mydatatype
  int x;
  int y;
ENDRECORD

VAR intnum msgreceive;
VAR mydatatype mydata;

PROC main()
  ! Setup interrupt
  CONNECT msgreceive WITH msghandler;
  ! Order cyclic interrupt to occur for data type mydatatype
  IRMQMessage mydata, msgreceive;
  WHILE TRUE DO
    ! Performing cycle
    ...
  ENDWHILE
ENDPROC

TRAP msghandler
  VAR rmqmessage message;
  VAR rmqheader header;

  ! Get the RMQ message
  RMQGetMessage message;
  ! Copy RMQ header information
  RMQGetMsgHeader message \Header:=header;

  IF header.datatype = "mydatatype" AND header.ndim = 0 THEN
    ! Copy the data from the message
    RMQGetMsgData message, mydata;
  ELSE
    TPWrite "Received a type not handled or with wrong dimension";
  ENDIF
ENDTRAP
```

When a new message is received, the trap routine `msghandler` is executed and the new message is copied to the variable `message` (instruction `RMQGetMessage`). Then the RMQ header data is copied (instruction `RMQGetMsgHeader`). If the message is of the expected data type and has the right dimension, the data is copied to the variable `mydata` (instruction `RMQGetMsgData`).

Syntax

```
RMQGetMsgData
  [ Message ':= ' ] < variable (VAR) of rmqmessage > ', '
  [ Data ':= ' ] < reference (VAR) of anytype > ';'
```

Continues on next page

1.223 RMQGetMsgData - Get the data part from an RMQ message FlexPendant Interface, PC Interface, or Multitasking Continued

Related information

For information about	See
Description of the RAPID Message Queue functionality	<i>Application manual - Controller software IRC5, section RAPID Message Queue.</i>
Find the identity number of a RAPID Message Queue task	RMQFindSlot - Find a slot identity from the slot name on page 626
Send data to the queue of a RAPID task	RMQSendMessage - Send an RMQ data message on page 640
Get the first message from a RAPID Message Queue.	RMQGetMessage - Get an RMQ message on page 628
Send data to the queue of a RAPID task and wait for an answer from the client	RMQSendWait - Send an RMQ data message and wait for a response on page 644
Extract the header data from an <code>rmqmessage</code>	RMQGetMsgHeader - Get header information from an RMQ message on page 634
Order and enable interrupts for a specific data type	IRMQMessage - Orders RMQ interrupts for a data type on page 301
Get the slot name from a specified slot identity	RMQGetSlotName - Get the name of an RMQ client on page 1445
RMQ Message	rmqmessage - RAPID Message Queue message on page 1731

1 Instructions

1.224 RMQGetMsgHeader - Get header information from an RMQ message *FlexPendant Interface, PC Interface, or Multitasking*

1.224 RMQGetMsgHeader - Get header information from an RMQ message

Usage

RMQGetMsgHeader (*RAPID Message Queue Get Message Header*) get the header information within the received RMQ message and store it in variables of type `rmqheader`, `rmqslot` or `num`.

Basic examples

The following examples illustrate the instruction `RMQGetMsgHeader`:

See also [More examples on page 635](#).

Example 1

```
VAR rmqmessage myrmqmsg;  
VAR rmqheader myrmqheader;  
...  
RMQGetMsgHeader myrmqmsg, \Header:=myrmqheader;
```

In this example the variable `myrmqheader` is filled with data copied from the `rmqheader` part of the variable `myrmqmsg`.

Example 2

```
VAR rmqmessage rmqmessage1;  
VAR rmqheader rmqheader1;  
VAR rmqslot rmqslot1;  
VAR num userdef := 0;  
...  
RRMQGetMsgHeader rmqmessage1 \Header:=rmqheader1 \SenderId:=rmqslot1  
  \UserDef:=userdef;
```

In this example the variables `rmqheader1`, `rmqslot1` and `userdef` are filled with data copied from the variable `rmqmessage1`.

Arguments

```
RMQGetMsgHeader Message [\Header] [\SenderId] [\UserDef]
```

Message

Data type: `rmqmessage`

Variable containing the received RMQ message from which the information about the message should be copied.

[\Header]

Data type: `rmqheader`

Variable for storage of the RMQ header information that is copied from the variable specified as the parameter `Message`.

[\SenderId]

Data type: `rmqslot`

Variable for storage of the sender identity information that is copied from the variable specified as the parameter `Message`.

Continues on next page

1.224 RMQGetMsgHeader - Get header information from an RMQ message *FlexPendant Interface, PC Interface, or Multitasking* *Continued*

[\UserDef]

User Defined data**Data type:** num

Variable for storage of user-defined data that is copied from the variable specified as the parameter `Message`. To get any valid data in this variable, the sender needs to specify that this should be included when sending an RMQ message. If it is not used, the value will be set to -1.

Program execution

The instruction `RMQGetMsgHeader` gets the header information within the received RMQ message and copies it to variables of type `rmqheader`, `rmqslot` or `num` depending on what arguments are used.

More examples

More examples of how to use the instruction `RMQGetMsgHeader` are illustrated below.

Example 1

```

RECORD mydatatype
  int x;
  int y;
ENDRECORD

VAR intnum msgreceive;
VAR mydatatype mydata;

PROC main()
  ! Setup interrupt
  CONNECT msgreceive WITH msghandler;
  ! Order cyclic interrupt to occur for data type mydatatype
  IRMQMessage mydata, msgreceive;
  WHILE TRUE DO
    ! Performing cycle
    ...
  ENDWHILE
ENDPROC

TRAP msghandler
  VAR rmqmessage message;
  VAR rmqheader header;

  ! Get the RMQ message
  RMQGetMessage message;
  ! Copy RMQ header information
  RMQGetMsgHeader message \Header:=header;

  IF header.datatype = "mydatatype" AND header.ndim = 0 THEN
    ! Copy the data from the message
    RMQGetMsgData message, mydata;
  
```

Continues on next page

1 Instructions

1.224 RMQGetMsgHeader - Get header information from an RMQ message

FlexPendant Interface, PC Interface, or Multitasking

Continued

```
ELSE
    TPWrite "Received a type not handled or with wrong dimension";
ENDIF
ENDTRAP
```

When a new message is received, the trap routine `msghandler` is executed and the new message is copied to the variable `message` (instruction `RMQGetMessage`). Then the RMQ header data is copied (instruction `RMQGetMsgHeader`). If the message is of the expected data type and has the right dimension, the data is copied to the variable `mydata` (instruction `RMQGetMsgData`).

Syntax

```
RMQGetMsgHeader
[ Message ':= ' ] < variable (VAR) of rmqmessage > ', '
[ '\ ' Header ':= ' < variable (VAR) of rmqheader >
[ '\ ' SenderId ':= ' < variable (VAR) of rmqslot >
[ '\ ' UserDef ':= ' < variable (VAR) of num > ';'
```

Related information

For information about	See
Description of the RAPID Message Queue functionality	Application manual - Controller software IRC5, section RAPID Message Queue.
Find the identity number of a RAPID Message Queue task	RMQFindSlot - Find a slot identity from the slot name on page 626
Send data to the queue of a RAPID task	RMQSendMessage - Send an RMQ data message on page 640
Get the first message from a RAPID Message Queue.	RMQGetMessage - Get an RMQ message on page 628
Send data to the queue of a RAPID task and wait for an answer from the client	RMQSendWait - Send an RMQ data message and wait for a response on page 644
Extract the data from an <code>rmqmessage</code>	RMQGetMsgData - Get the data part from an RMQ message on page 631
Order and enable interrupts for a specific data type	IRMQMessage - Orders RMQ interrupts for a data type on page 301
Get the slot name from a specified slot identity	RMQGetSlotName - Get the name of an RMQ client on page 1445
RMQ Slot	rmqslot - Identity number of an RMQ client on page 1732
RMQ Header	rmqmessage - RAPID Message Queue message on page 1731
RMQ Message	rmqheader - RAPID Message Queue Message header on page 1729

1.225 RMQReadWait - Returns message from RMQ FlexPendant Interface, PC Interface, or Multitasking

1.225 RMQReadWait - Returns message from RMQ

Usage

`RMQReadWait` is used in synchronous mode to receive any type of message.

Basic examples

The following example illustrates the instruction `RMQReadWait`:

See also [More examples on page 638](#).

Example

```
VAR rmqmessage myrmqmsg;
RMQReadWait myrmqmsg;
```

The first message in the queue is received in the variable `myrmqmsg`.

Arguments

`RMQReadWait Message [\Timeout]`

Message

Data type: `rmqmessage`

The variable in which the received message is placed.

[\Timeout]

Data type: `num`

The maximum amount of time [s] that program execution waits for a message. If this time runs out before the condition is met, the error handler will be called, if there is one, with the error code `ERR_RMQ_TIMEOUT`. If there is no error handler, the execution will be stopped. It is possible to set the timeout to 0 (zero) seconds, so that there is no wait at all.

If the parameter `\Timeout` is not used, the waiting time is 60 sec. To wait forever, use the predefined constant `WAIT_MAX`.

Program execution

All incoming messages are queued and `RMQReadWait` handles the messages in FIFO order, one message at a time. It is the users responsibility to avoid a full queue and to be prepared to handle any type of message supported by RAPID Message Queue.

Error handling

The following recoverable errors are generated and can be handled in an error handler. The system variable `ERRNO` will be set to:

Name	Cause of error
<code>ERR_RMQ_TIMEOUT</code>	No answer has been received within the time-out time
<code>ERR_RMQ_INVMSG</code>	This error will be thrown if the message is invalid. This can for example happen if a PC application sends a corrupt message

Continues on next page

1 Instructions

1.225 RMQReadWait - Returns message from RMQ FlexPendant Interface, PC Interface, or Multitasking Continued

More examples

More examples of how to use the instruction `RMQReadWait` are illustrated below.

Example 1

```
VAR rmqmessage myrmqmsg;  
RMQReadWait myrmqmsg \Timeout:=30;
```

The first message in the queue is received in the variable `myrmqmsg`. If no message is received within 30 seconds the program execution is stopped.

Example 2

```
PROC main()  
  VAR rmqmessage myrmqmsg;  
  FOR i FROM 1 TO 25 DO  
    RMQReadWait myrmqmsg \Timeout:=30;  
    ...  
  ENDFOR  
  
  ERROR  
  IF ERRNO = ERR_RMQ_TIMEOUT THEN  
    TPWrite "ERR_RMQ_TIMEOUT error reported";  
    ...  
  ENDIF  
ENDPROC
```

Messages are received from the queue and stored in the variable `myrmqmsg`. If receiving a message takes longer than 30 seconds, the error handler is called.

Limitations

`RMQReadWait` is only supported in synchronous mode. Executing this instruction in interrupt based mode will cause a fatal runtime error.

`RMQReadWait` is not supported in trap execution level or user execution level. Executing this instruction in either of these levels will cause a fatal runtime error.

Syntax

```
RMQReadWait  
  [ Message := ] < variable (VAR) of rmqmessage >  
  [ '\ Timeout' := ] < expression (IN) of num > ] ;'
```

Related information

For information about	See
Description of the RAPID Message Queue functionality	<i>Application manual - Controller software IRC5, section RAPID Message Queue.</i>
Description of task execution modes	<i>Technical reference manual - System parameters</i>
<code>rmqmessage</code> data type	rmqmessage - RAPID Message Queue message on page 1731.
Send data to the queue of a RAPID task	RMQSendMessage - Send an RMQ data message on page 640.

Continues on next page

1.225 RMQReadWait - Returns message from RMQ FlexPendant Interface, PC Interface, or Multitasking Continued

For information about	See
Send data to the queue of a RAPID task and wait for an answer from the client	RMQSendWait - Send an RMQ data message and wait for a response on page 644.
Find the identity number of a RAPID Message Queue task	RMQFindSlot - Find a slot identity from the slot name on page 626.
Extract the header data from an <code>rmqmessage</code>	RMQGetMsgHeader - Get header information from an RMQ message on page 634.
Extract the data from an <code>rmqmessage</code>	RMQGetMsgData - Get the data part from an RMQ message on page 631.
Order and enable interrupts for a specific data type	IRMQMessage - Orders RMQ interrupts for a data type on page 301.
Get the slot name from a specified slot identity	RMQGetSlotName - Get the name of an RMQ client on page 1445.
Empty RAPID Message Queue	RMQEmptyQueue - Empty RAPID Message Queue on page 624.
Get the first message from a RAPID Message Queue	RMQGetMessage - Get an RMQ message on page 628.

1 Instructions

1.226 RMQSendMessage - Send an RMQ data message *FlexPendant Interface, PC Interface, or Multitasking*

1.226 RMQSendMessage - Send an RMQ data message

Usage

RMQSendMessage (*RAPID Message Queue Send Message*) is used to send data to an RMQ configured for a RAPID task, or to a Robot Application Builder client.

Basic examples

The following examples illustrate the instruction RMQSendMessage:

See also [More examples on page 641](#).

Example 1

```
VAR rmqslot destination_slot;  
VAR string data:="Hello world";  
..  
RMQFindSlot destination_slot,"RMQ_Task2";  
RMQSendMessage destination_slot,data;
```

The example shows how to send the value in the variable `data` to the RAPID task "Task2" with the configured RMQ "RMQ_Task2".

Example 2

```
VAR rmqslot destination_slot;  
CONST robtarget p5:=[ [600, 500, 225.3], [1, 0, 0, 0], [1, 1, 0,  
0], [ 11, 12.3, 9E9, 9E9, 9E9, 9E9] ];  
VAR num my_id:=1;  
..  
RMQFindSlot destination_slot,"RMQ_Task2";  
RMQSendMessage destination_slot, p5 \UserDef:=my_id;  
my_id:=my_id + 1;
```

The example shows how to send the value in the constant `p5` to the RAPID task "Task2" with the configured RMQ "RMQ_Task2". A user-defined number is also sent. This number can be used by the receiver as an identifier.

Arguments

```
RMQSendMessage Slot SendData [\UserDef]
```

Slot

Data type: `rmqslot`

The identity slot number of the client that should receive the message.

SendData

Data type: `anytype`

Reference to a variable, persistent or constant containing the data to be sent to the client with identity as in argument `Slot`.

[\UserDef]

User Defined data

Data type: `num`

Continues on next page

1.226 RMQSendMessage - Send an RMQ data message FlexPendant Interface, PC Interface, or Multitasking Continued

Data specifying user-defined information to the receiver of the `SendData`, i.e the client with identity number as in variable `Slot`. The value must be an integer between 0 and 32767.

Program execution

The instruction `RMQSendMessage` is used to send data to a specified client. The instruction packs the indata in a storage container and sends it.

If the receiving client is not interested in receiving messages, i.e has not setup any interrupt to occur for the data type specified in the `RMQSendMessage` instruction or is not waiting in an `RMQSendWait` instruction, the message will be discarded, and a warning will be generated.

Not all data types can be sent with the instruction (see limitations).

Error handling

The following recoverable errors are generated and can be handled in an error handler. The system variable `ERRNO` will be set to:

Name	Cause of error
<code>ERR_RMQ_MSGSIZE</code>	The size of message is too big. Either the data exceeds the maximum allowed message size, or the receiving client is not configured to receive the size of the data that is sent.
<code>ERR_RMQ_FULLL</code>	The destination message queue is full.
<code>ERR_RMQ_INVALID</code>	The destination slot has not been connected or the destination slot is no longer available. If not connected, a call to <code>RMQFindSlot</code> must be done. If not available, the reason is that a remote client has disconnected from the controller.

More examples

More examples of how to use the instruction `RMQSendMessage` are illustrated below.

Example 1

```

MODULE SenderMod
  RECORD msgrec
    num x;
    num y;
  ENDRECORD

  PROC main()
    VAR rmqslot destinationSlot;
    VAR msgrec msg :=[0, 0, 0];

    ! Connect to a Robot Application Builder client
    RMQFindSlot destinationSlot "My_RAB_client";

    ! Perform cycle
    WHILE TRUE DO
      ! Update msg with valid data
      ...
      ! Send message
    
```

Continues on next page

1 Instructions

1.226 RMQSendMessage - Send an RMQ data message

FlexPendant Interface, PC Interface, or Multitasking

Continued

```
        RMQSendMessage destinationSlot, msg;
        ...
    ENDWHILE
ERROR
    IF ERRNO = ERR_RMQ_INVALID THEN
        ! Handle destination client lost
        WaitTime 1;
        ! Reconnect to Robot Application Builder client
        RMQFindSlot destinationSlot "My_RAB_client";
        ! Avoid execution stop due to retry count exceed
        ResetRetryCount;
        RETRY;
    ELSIF ERRNO = ERR_RMQ_FULL THEN
        ! Handle destination queue full
        WaitTime 1;
        ! Avoid execution stop due to retry count exceed
        ResetRetryCount;
        RETRY;
    ENDIF
ENDPROC
ENDMODULE
```

The example shows how to use instruction `RMQSendMessage` with errorhandling of occurring run-time errors. The program sends user-defined data of the type `msgrec` to a Robot Application Builder client called "My_RAB_client".

Limitations

It is not possible to set up interrupts, or send or receive data instances of data types that are of non-value, semi-value types or data type `motsetdata`.

The maximum size of data that can be sent to a Robot Application Builder client is about 5000 bytes. The maximum size of data that can be received by a RMQ and stored in a `rmqmessage` data type is about 3000 bytes. The size of the data that can be received by an RMQ can be configured (default size 400, max size 3000).

Syntax

```
RMQSendMessage
[ Slot ':' = ] < variable (VAR) of rmqslot > ','
[ SendData ':' = ] < reference (REF) of anytype >
[ '\ ' UserDef ':' = ] < expression (IN) of num > ] ';' ;'
```

Related information

For information about	See
Description of the RAPID Message Queue functionality	<i>Application manual - Controller software IRC5</i> , section <i>RAPID Message Queue</i> .
Find the identity number of a RAPID Message Queue task	RMQFindSlot - Find a slot identity from the slot name on page 626
Get the first message from a RAPID Message Queue.	RMQGetMessage - Get an RMQ message on page 628

Continues on next page

1.226 RMQSendMessage - Send an RMQ data message FlexPendant Interface, PC Interface, or Multitasking Continued

For information about	See
Send data to the queue of a RAPID task and wait for an answer from the client	RMQSendWait - Send an RMQ data message and wait for a response on page 644
Extract the header data from an <code>rmqmessage</code>	RMQGetMsgHeader - Get header information from an RMQ message on page 634
Extract the data from an <code>rmqmessage</code>	RMQGetMsgData - Get the data part from an RMQ message on page 631
Order and enable interrupts for a specific data type	IRMQMessage - Orders RMQ interrupts for a data type on page 301
Get the slot name from a specified slot identity	RMQGetSlotName - Get the name of an RMQ client on page 1445
RMQ Slot	rmqslot - Identity number of an RMQ client on page 1732

1 Instructions

1.227 RMQSendWait - Send an RMQ data message and wait for a response *FlexPendant Interface, PC Interface, or Multitasking*

1.227 RMQSendWait - Send an RMQ data message and wait for a response

Usage

With the `RMQSendWait` (*RAPID Message Queue Send Wait*) instruction it is possible to send data to an RMQ or to a Robot Application Builder client, and wait for an answer from the specified client. If using this instruction, the user needs to know what kind of data type will be sent in the answer from the client.

Basic examples

The following examples illustrate the instruction `RMQSendWait`:

See also [More examples on page 647](#).

Example 1

```
VAR rmqslot destination_slot;
VAR string sendstr:="This string is from T_ROB1";
VAR rmqmessage receivemsg;
VAR num mynum;
..
RMQFindSlot destination_slot, "RMQ_T_ROB2";
RMQSendWait destination_slot, sendstr, receivemsg, mynum;
RMQGetMsgData receivemsg, mynum;
```

The example shows how to send the data in the variable `sendstr` to the RAPID task "T_ROB2" with the configured RMQ "RMQ_T_ROB2". Now the instruction `RMQSendWait` waits for a reply from the task "T_ROB2". The instruction in "T_ROB2" needs to send data that is stored in a `num` data type to terminate the waiting instruction `RMQSendWait`. When the message has been received, the data is copied to the variable `mynum` from the variable `receivemsg` with the instruction `RMQGetMsgData`.

Example 2

```
VAR rmqslot rmqslot1;
VAR string mysendstr;
VAR rmqmessage rmqmessage1;
VAR string receivestr;
VAR num mysendid:=1;
..
mysendstr:="Message from Task1";
RMQFindSlot rmqslot1, "RMQ_Task2";
RMQSendWait rmqslot1, mysendstr \UserDef:=mysendid, rmqmessage1,
    receivestr \Timeout:=20;
RMQGetMsgData rmqmessage1, receivestr;
mysendid:=mysendid + 1;
```

The example shows how to send the data in the variable `mysendstr` to the RAPID task "Task2" with the configured RMQ "RMQ_Task2". A user-defined number is also sent. This number can be used by the receiver as an identifier and must be bounced back to the sender to terminate the waiting `RMQSendWait` instruction. Another demand to terminate the waiting instruction is that the right data type is sent from the client. That data type is specified by the variable `receivestr` in the

Continues on next page

1.227 RMQSendWait - Send an RMQ data message and wait for a response *FlexPendant Interface, PC Interface, or Multitasking* *Continued*

`RMQSendWait` instruction. After the message has been received, the actual data is copied to the variable `receivestr` with the instruction `RMQGetMsgData`.

Arguments

```
RMQSendWait Slot SendData [\UserDef] Message ReceiveDataType  
[\Timeout]
```

Slot

Data type: `rmqslot`

The identity number of the client that should receive the message.

SendData

Data type: `anytype`

Reference to a variable, persistent or constant containing the data to be sent to the client with identity number as in the variable `Slot`.

[\UserDef]

User Defined data

Data type: `num`

Data specifying user-defined information to the receiver of the `SendData`, that is, the client with the identity number as in the variable `Slot`. If using this optional argument, the `RMQSendWait` instruction will only terminate if the `ReceiveDataType` and the specified `UserDef` is as specified in the message answer. The value must be an integer between 0 and 32767.

Message

Data type: `rmqmessage`

The variable in which the received message is placed.

ReceiveDataType

Data type: `anytype`

A reference to a persistent, variable or constant of the data type that the instruction is waiting for. The actual data is not copied to this variable when the `RMQSendWait` is executed. This argument is only used to specify the actual data type the `RMQSendWait` instruction is waiting for.

[\Timeout]

Data type: `num`

The maximum amount of time [s] that program execution waits for an answer. If this time runs out before the condition is met, the error handler will be called, if there is one, with the error code `ERR_RMQ_TIMEOUT`. If there is no error handler, the execution will be stopped.

If the parameter `\Timeout` is not used, the waiting time is 60 s. To wait forever, use the predefined constant `WAIT_MAX`.

Continues on next page

1 Instructions

1.227 RMQSendWait - Send an RMQ data message and wait for a response

FlexPendant Interface, PC Interface, or Multitasking

Continued

Program execution

The instruction `RMQSendWait` sends data and waits for an answer from the client with the specified slot identity. The answer must be an `rmqmessage` from the client that got the message and the answer must be of the same data type that is specified in the argument `ReceiveDataType`. The message will be sent in the same way as when using `RMQSendMessage`, i.e. the receiver will get a normal RAPID Message Queue message. It is the responsibility of the sender that the receiver knows that a reply is needed. If the optional argument `UserDef` is used in the `RMQSendWait`, the demand is that the receiving client uses the same `UserDef` in the answer.

If the receiving client is not interested in receiving messages, that is, has not set up any interrupt to occur for the data type specified in the `RMQSendWait` instruction, the message will be discarded, and a warning will be generated. The instruction returns an error after the time used in the argument `TimeOut`, or the default time-out time 60 s. This error can be dealt with in an error handler.

The `RMQSendWait` instruction has the highest priority if a message is received and it fits the description for both the expected answer and a message connected to a trap routine (see instruction [IRMQMessage - Orders RMQ interrupts for a data type on page 301](#)).

If a power failure occurs when waiting for an answer from the client, the variable used in the argument `Slot` is set to 0 and the instruction is executed again. The instruction will then fail because of an invalid slot identity and the error handler will be called, if there is one, with the error code `ERR_RMQ_INVALID`. The slot identity can be reinitialized there.

Not all data types can be sent with the instruction (see limitations).

Error handling

The following recoverable errors are generated and can be handled in an error handler. The system variable `ERRNO` will be set to:

Name	Cause of error
<code>ERR_RMQ_MSGSIZE</code>	The size of message is too big. Either the data exceeds the maximum allowed message size, or the receiving client is not configured to receive the size of the data that is sent.
<code>ERR_RMQ_FULL</code>	The destination message queue is full.
<code>ERR_RMQ_INVALID</code>	The <code>rmqslot</code> has not been initialized, or the destination slot is no longer available. This can happen if the destination slot is a remote client and the remote client has disconnected from the controller. <code>RMQSendWait</code> was interrupted by a power failure, and at restart the <code>rmqslot</code> is set to 0.
<code>ERR_RMQ_TIMEOUT</code>	No answer has been received within the time-out time.
<code>ERR_RMQ_INVMSG</code>	This error will be thrown if the message is invalid. This may for instance happen if a PC application sends a corrupt message.

Continues on next page

1.227 RMQSendWait - Send an RMQ data message and wait for a response *FlexPendant Interface, PC Interface, or Multitasking* Continued

More examples

More examples of how to use the instruction `RMQSendWait` are illustrated below.

Example 1

```

MODULE RMQ_Task1_mod
PROC main()
  VAR rmqslot destination_slot;
  VAR string mysendstr:="String sent from RMQ_Task1_mod";
  VAR string myrecstr;
  VAR rmqmessage recmsg;
  VAR rmqheader header;

  !Get slot identity to client called RMQ_Task2
  RMQFindSlot destination_slot, "RMQ_Task2";

  WHILE TRUE DO
    ! Do something
    ...
    !Send data in mysendstr, wait for an answer of type string
    RMQSendWait destination_slot, mysendstr, recmsg, myrecstr;
    !Get information about the received message
    RMQGetMsgHeader recmsg \Header:=header;
    IF header.datatype = "string" AND header.ndim = 0 THEN
      ! Copy the data in recmsg
      RMQGetMsgData recmsg, myrecstr;
      TPWrite "Received string: " + myrecstr;
    ELSE
      TPWrite "Not a string that was received";
    ENDIF
  ENDWHILE
ENDPROC
ENDMODULE

```

The data in the variable `mysendstr` is sent to the RAPID task "Task2" with the configured RAPID Message Queue "RMQ_Task2" with the instruction `RMQSendWait`. The answer from the RAPID task "Task2" should be a string (specified of the data type of the variable `myrecstr`). The RMQ message received as an answer is received in the variable `recmsg`. The use of the variable `myrecstr` in the call to `RMQSendWait` is just specification of the data type the sender is expecting as an answer. No valid data is placed in the variable in the `RMQSendWait` call.

Limitations

It is not allowed to execute `RMQSendWait` in synchronous mode. That will cause a fatal runtime error.

It is not possible to set up interrupts, or send or receive data instances of data types that are of non-value, semi-value types or data type `motsetdata`.

The maximum size of data that can be sent to a Robot Application Builder client is about 5000 bytes. The maximum size of data that can be received by an RMQ and stored in an `rmqmessage` data type is about 3000 bytes. The size of the data

Continues on next page

1 Instructions

1.227 RMQSendWait - Send an RMQ data message and wait for a response

FlexPendant Interface, PC Interface, or Multitasking

Continued

that can be received by an RMQ can be configured (default size 400, max size 3000).

Syntax

```
RMQSendWait
[ Slot ':' ] < variable (VAR) of rmqslot > ','
[ SendData ':' ] < reference (REF) of anytype >
[ '\ UserDef ':' ] < expression (IN) of num > ','
[ Message ':' ] < variable (VAR) of rmqmessage > ','
[ ReceiveDataType ':' ] < reference (REF) of anytype > ','
[ '\ Timeout ':' ] < expression (IN) of num > ';' ;'
```

Related information

For information about	See
Description of the RAPID Message Queue functionality	Application manual - Controller software IRC5, section RAPID Message Queue.
Find the identity number of a RAPID Message Queue task	RMQFindSlot - Find a slot identity from the slot name on page 626
Send data to the queue of a RAPID task	RMQSendMessage - Send an RMQ data message on page 640
Get the first message from a RAPID Message Queue.	RMQGetMessage - Get an RMQ message on page 628
Extract the header data from an <code>rmqmessage</code>	RMQGetMsgHeader - Get header information from an RMQ message on page 634
Extract the data from an <code>rmqmessage</code>	RMQGetMsgData - Get the data part from an RMQ message on page 631
Order and enable interrupts for a specific data type	IRMQMessage - Orders RMQ interrupts for a data type on page 301
Get the slot name from a specified slot identity	RMQGetSlotName - Get the name of an RMQ client on page 1445
RMQ Slot	rmqslot - Identity number of an RMQ client on page 1732
RMQ Message	rmqmessage - RAPID Message Queue message on page 1731

1.228 SafetyControllerSyncRequest - Initiation of hardware synchronization procedure

SafeMove Basic, SafeMove Pro, PROFIsafe

1.228 SafetyControllerSyncRequest - Initiation of hardware synchronization procedure

Usage

`SafetyControllerSyncRequest` is used to initiate the hardware synchronization procedure.

Basic examples

The following example illustrates the instruction `SafetyControllerSyncRequest`.

Example 1

```
SafetyControllerSyncRequest ;
Initiate the hardware synchronization procedure.
```

Program execution

This instruction must be called prior to the synchronization signal activation.

Syntax

```
SafetyControllerSyncRequest ' ;'
```

Related information

For information about	See
<code>SafetyControllerGetChecksum</code>	SafetyControllerGetChecksum - Get the checksum for the user configuration file on page 1456
<code>SafetyControllerGetSWVersion</code>	SafetyControllerGetSWVersion - Get the safety controller firmware version on page 1458
<code>SafetyControllerGetUserChecksum</code>	SafetyControllerGetUserChecksum - Get the checksum for protected parameters on page 1459

1 Instructions

1.229 Save - Save a program module *RobotWare Base*

1.229 Save - Save a program module

Usage

Save is used to save a program module.

The specified program module in the program memory will be saved with the original (specified in Load or StartLoad) or specified file path.

It is also possible to save a system module at the specified file path.

Basic examples

The following example illustrates the instruction Save:

See also [More examples on page 651](#).

Example 1

```
Load "HOME:/PART_B.MOD";  
...  
Save "PART_B";
```

Load the program module with the file name PART_B.MOD from HOME: into the program memory.

Save the program module PART_B with the original file path HOME: and with the original file name PART_B.MOD.

Arguments

```
Save [\TaskRef][\TaskName] ModuleName [\FilePath] [\File]
```

[\TaskRef]

Task Reference

Data type: taskid

The program task identity in which the program module should be saved.

For all program tasks in the system the predefined variables of the data type taskid will be available. The variable identity will be "taskname"+"Id", e.g. for the T_ROB1 task the variable identity will be T_ROB1Id.

[\TaskName]

Data type: string

The program task name in which the program module should be saved.

If none of the arguments \TaskRef or \TaskName is specified then the specified program module in the current (executing) program task will be saved.

ModuleName

Data type: string

The program module to save.

[\FilePath]

Data type: string

The file path and the file name to the place where the program module is to be saved. The file name shall be excluded when the argument \File is used.

Continues on next page

`[\File]`

Data type: `string`

When the file name is excluded in the argument `\FilePath` it must be specified with this argument.

The argument `\FilePath\File` can only be omitted for program modules loaded with `Load` or `StartLoad-WaitLoad` and the program module will be stored at the same destination as specified in these instructions. To store the program module at another destination it is also possible to use the argument `\FilePath\File`.

The argument `\FilePath \File` must be used to be able to save a program module that previously was loaded from the FlexPendant, external computer, or system configuration.

Program execution

Program execution waits for the program module to finish saving before proceeding with the next instruction.

Error handling

The following recoverable errors are generated and can be handled in an error handler. The system variable `ERRNO` will be set to:

Name	Cause of error
<code>ERR_IOERROR</code>	The save file cannot be opened because of denied permission, no such directory, or no space left on device.
<code>ERR_MODULE</code>	The program module cannot be saved because there is no module name, unknown module name, or ambiguous module name.
<code>ERR_PATH</code>	The argument <code>\FilePath</code> is not specified for program modules loaded from the FlexPendant, System Parameters, or an external computer.
<code>ERR_TASKNAME</code>	The program task name in argument <code>\TaskName</code> cannot be found in the system.

More examples

More examples of how to use the instruction `Save` are illustrated below.

Example 1

```
Save "PART_A" \FilePath:="HOME:/DOORDIR/PART_A.MOD";
```

Save the program module `PART_A` to `HOME:` in the file `PART_A.MOD` and in the directory `DOORDIR`.

Example 2

```
Save "PART_A" \FilePath:="HOME:" \File:="DOORDIR/PART_A.MOD";
```

Same as in the above example 1 but another syntax.

Example 3

```
Save \TaskRef:=TSK1Id, "PART_A"
\FilePath:="HOME:/DOORDIR/PART_A.MOD";
```

Continues on next page

1 Instructions

1.229 Save - Save a program module

RobotWare Base

Continued

Save program module `PART_A` in program task `TSK1` to the specified destination. This is an example where the instruction `Save` is executing in one program task and the saving is done in another program task.

Example 4

```
Save \TaskName:="TSK1", "PART_A"  
    \FilePath:="HOME:/DOORDIR/PART_A.MOD";
```

Save program module `PART_A` in program task `TSK1` to the specified destination. This is another example of where the instruction `Save` is executing in one program task and the saving is done in another program task.

Limitations

Trap routines, system I/O events, and other program tasks cannot execute during the saving operation. Therefore, any such operations will be delayed.

The save operation can interrupt update of PERS data done step by step from other program tasks. This will result in inconsistent whole PERS data.

A program stop during execution of the `Save` instruction can result in a guard stop with motors off. The error message "20025 Stop order timeout" will be displayed on the FlexPendant.

Avoid ongoing robot movements during the saving.

Syntax

```
Save  
    [[ '\ ' TaskRef := ' <variable (VAR) of taskid>  
    | [ '\ ' TaskName := ' <expression (IN) of string> ] ', '  
    [ ModuleName := ' ] <expression (IN) of string>  
    [ '\ ' FilePath := ' <expression (IN) of string> ]  
    [ '\ ' File := ' <expression (IN) of string> ] ';' ;
```

Related information

For information about	See
Program tasks	taskid - Task identification on page 1771

1.230 SaveCfgData - Save system parameters to file

Usage

SaveCfgData is used to save system parameters to file. This can be useful after updating the system parameters with instruction WriteCfgData.

Basic examples

The following examples illustrates the instruction SaveCfgData.

Example 1

```
SaveCfgData "SYSPAR" \File:="MYEIO.cfg", EIO_DOMAIN;
```

Saving I/O configuration domain to the file MYEIO.cfg in directory SYSPAR.

Example 2

```
SaveCfgData "SYSPAR", ALL_DOMAINS;
```

Saving all existing configuration domains to directory SYSPAR. The files will get the names EIO.cfg, MMC.cfg, PROC.cfg, SIO.cfg, SYS.cfg and MOC.cfg.

Arguments

```
SaveCfgData FilePath [\File] Domain
```

FilePath

Data type: string

The file path and the file name to where the file should be saved. The file name shall be excluded when the argument \File is used.

[\File]

Data type: string

When the file name is excluded in the argument \FilePath it must be specified with this argument.

Domain

Data type: cfgdomain

The system parameter domain to save.

Program execution

Saves system parameters to file.

Error handling

The following recoverable errors are generated and can be handled in an error handler. The system variable ERRNO will be set to:

Name	Cause of error
ERR_CFG_ILL_DOMAIN	The cfgdomain used is invalid or not in use.
ERR_CFG_WRITEFILE	The directory does not exist, or the FilePath and File used is a directory, or some other problem regarding saving the file.

Continues on next page

1 Instructions

1.230 SaveCfgData - Save system parameters to file

RobotWare Base

Continued

Syntax

```
SaveCfgData
  [FilePath ':= ' ] <expression (IN) of string>
  ['\ ' File ':= ' <expression (IN) of string>]
  [Domain ':= ' ] <expression (IN) of cfgdomain> ';'

```

Related information

For information about	See
cfgdomain data	cfgdomain - Configuration domain on page 1635
System parameters	<i>Technical reference manual - System parameters</i>

1.231 SCWrite - Send variable data to a client application

Usage

SCWrite (*Superior Computer Write*) is used to send the name, type, dimension, and value of a persistent variable to a client application. It is possible to send both single variables and arrays of variables.

Basic examples

The following examples illustrate the instruction SCWrite:

Example 1

```
PERS num cycle_done;

PERS num numarr{2}:=[1,2];

SCWrite cycle_done;
```

The name, type, and value of the persistent variable `cycle_done` is sent to all client applications.

Example 2

```
SCWrite \ToNode := "138.221.228.4", cycle_done;
```

The name, type, and value of the persistent variable `cycle_done` is sent to all client applications. The argument `\ToNode` will be ignored.

Example 3

```
SCWrite numarr;
```

The name, type, dim, and value of the persistent variable `numarr` is sent to all client applications.

Example 4

```
SCWrite \ToNode := "138.221.228.4", numarr;
```

The name, type, dim, and value of the persistent variable `numarr` is sent to all client applications. The argument `\ToNode` will be ignored.

Arguments

```
SCWrite [ \ToNode ] Variable
```

[`\ToNode`]

Data type: datatype

The argument will be ignored.

Variable

Data type: anytype

The name of a persistent variable.

Program execution

The name, type, dim, and value of the persistent variable is sent to all client applications. 'dim' is the dimension of the variable and is only sent if the variable is an array.

Continues on next page

1 Instructions

1.231 SCWrite - Send variable data to a client application

PC interface/backup

Continued

Error handling

The following recoverable errors are generated and can be handled in an error handler. The system variable `ERRNO` will be set to:

Name	Cause of error
<code>ERR_SC_WRITE</code>	Error when sending to external computer.

The `SCWrite` instruction will return an error in the following cases:

The variable could not be sent to the client. This can have the following cause:

- The `SCWrite` messages comes so close so that they cannot be sent to the client. **Solution:** Put in a `WaitTime` instruction between the `SCWrite` instructions.
- The variable value is too large decreasing the size of the `ARRAY` or `RECORD`.
- The error message will be: 41473 System access error, Failed to send variable `arg1`, where `arg1` is the name of the variable.

The `SCWrite` instruction will not return an error if the client application may, for example, be closed down or the communication is down. The program will continue executing.

`SCWrite` error recovery

To avoid stopping the program when a error occurs in a `SCWrite` instruction it has to be handled by an *error handler*. The error will only be reported to the log, and the program will continue running.

Remember that the error handling will make it more difficult to find errors in the client communication since the error is never reported to the display on the FlexPendant (but it can be found in the log).

Continues on next page

The RAPID program looks as follows:

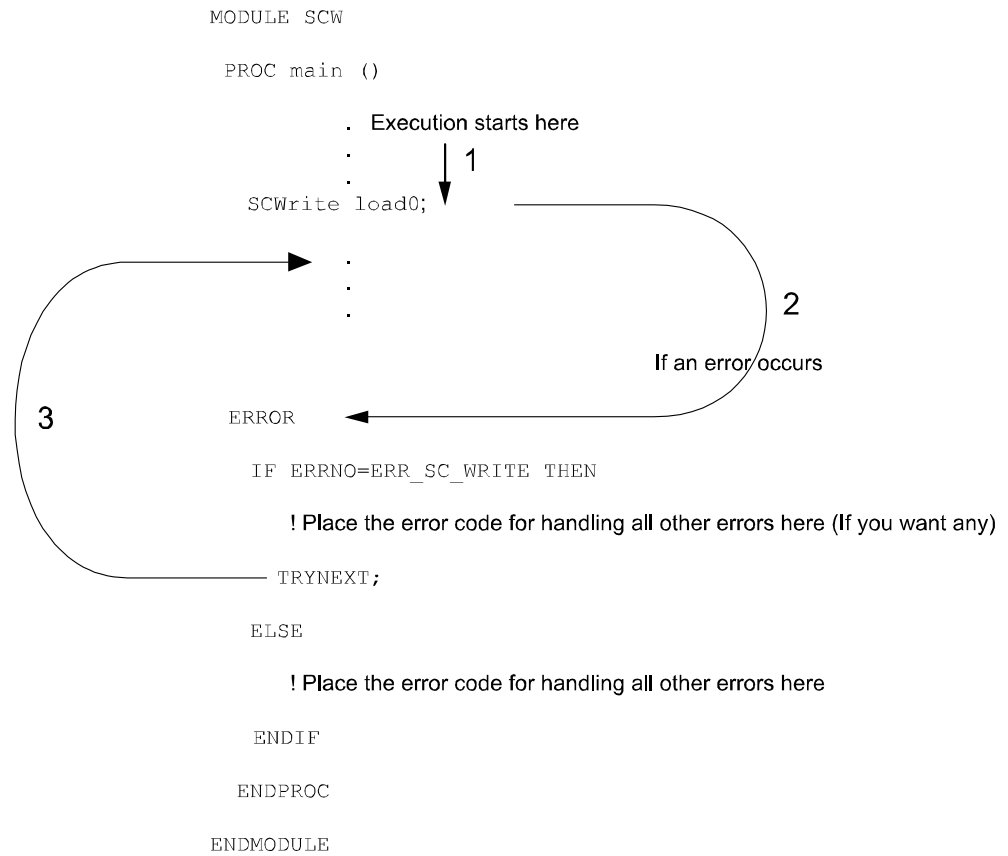

xx0500002339

1 Instructions

1.232 SearchC - Searches circularly using the robot *RobotWare Base*

1.232 SearchC - Searches circularly using the robot

Usage

`SearchC` (*Search Circular*) is used to search for a position when moving the tool center point (TCP) circularly.

During the movement the robot supervises a digital input signal or a persistent variable. When the value of the signal or persistent variable changes to the requested one the robot immediately reads the current position.

This instruction can typically be used when the tool held by the robot is a probe for surface detection. The outline coordinates of a work object can be obtained using the `SearchC` instruction.

This instruction can only be used in the main task `T_ROB1` or, if in a *MultiMove* system, in Motion tasks.

When using search instructions it is important to configure the I/O system to have a very short time from setting the physical signal to the system to getting the information regarding the setting (use I/O device with interrupt control, not poll control). How to do this can differ between fieldbuses. If using DeviceNet the ABB units (local I/O) will give short times since they are using connection type *Change of State*. If using other fieldbuses ensure that you configure the network in a proper way to get right conditions.

Basic examples

The following examples illustrate the instruction `SearchC`:

See also [More examples on page 665](#).

Example 1

```
SearchC di1, sp, cirpoint, p10, v100, probe;
```

The TCP of the `probe` is moved circularly towards the position `p10` at a speed of `v100`. When the value of the signal `di1` changes to active the position is stored in `sp`.

Example 2

```
SearchC \Stop, di2, sp, cirpoint, p10, v100, probe;
```

The TCP of the `probe` is moved circularly towards the position `p10`. When the value of the signal `di2` changes to active the position is stored in `sp` and the robot stops immediately.

Example 3

```
PERS bool mypers:=FALSE;  
...  
SearchC \Stop, mypers, sp, cirpoint, p10, v100, probe;
```

The TCP of the `probe` is moved circularly towards the position `p10`. When the value of the persistent variable `mypers` changes to `TRUE` the position is stored in `sp` and the robot stops immediately.

Continues on next page

Arguments

```
SearchC [\Stop] | [\PStop] | [\SStop] | [\Sup] Signal | PersBool
[\Flanks] | [\PosFlank] | [\NegFlank] | [\HighLevel] |
[\LowLevel] SearchPoint CirPoint ToPoint [\ID] Speed [\V] |
[\T] Tool [\WObj] [\Corr] [\TLoad]
```

[\Stop]

Stiff StopData type: *switch*

The robot movement is stopped as quickly as possible without keeping the TCP on the path (hard stop) when the value of the search signal changes to active or the persistent variable value changes to TRUE. The robot is moved a small distance before it stops and is not moved back to the searched position, i.e. to the position where the signal or persistent value changed.

Test first with a slow speed, for example <100 mm/s, and then gradually increase the speed to the desired value.

**WARNING**

Stopping the search with a stiff stop (switch `\Stop`) is only allowed if the TCP-speed is lower than 100 mm/s. A stiff stop at higher speed can cause some axes to move in unpredictable directions.

**Note**

For a YuMi robot, the maximum speed for searching with stiff stop is 1000 mm/s.

[\PStop]

Path StopData type: *switch*

The robot movement is stopped as quickly as possible while keeping the TCP on the path (soft stop) when the value of the search signal changes to active or the persistent variable value changes to TRUE. The robot is moved a distance before it stops and is not moved back to the searched position, i.e. to the position where the signal or persistent value changed.

[\SStop]

Soft StopData type: *switch*

The robot movement is stopped as quickly as possible while keeping the TCP close to or on the path (soft stop) when the value of the search signal changes to active or the persistent variable value changes to TRUE. The robot is moved only a small distance before it stops and is not moved back to the searched position, i.e. to the position where the signal changed. `SStop` is faster than `PStop`. But when the robot is running faster than 100 mm/s it stops in the direction of the tangent of the movement which causes it to marginally slide of the path.

Continues on next page

1 Instructions

1.232 SearchC - Searches circularly using the robot

RobotWare Base

Continued

[\Sup]

Supervision

Data type: `switch`

The search instruction is sensitive to signal activation or persistent variable value change during the complete movement (flying search), i.e. even after the first signal change or persistent variable change has been reported. If more than one match occurs during a search then a recoverable error is generated with the robot in the `ToPoint`.

If the arguments `\Stop`, `\PStop`, `\SStop`, and `\Sup` are omitted (no switch used at all):

- the movement continues (flying search) to the position specified in the `ToPoint` argument (same as with argument `\Sup`)
- error is reported for none search hit but is not reported for more than one search hit (first search hit is returned as the `SearchPoint`)

Signal

Data type: `signal`

The name of the signal to supervise.

PersBool

Data type: `bool`

The persistent variable to supervise.

[\Flanks]

Data type: `switch`

The positive and the negative edge of the signal is valid for a search hit. If using argument `PersBool` it is the value change of the variable that is valid for a search hit.

For signal: If the argument `\Flanks` is omitted, only the positive edge of the signal is valid for a search hit and a signal supervision will be activated at the beginning of a search process. This means that if the signal has the positive value already at the beginning of a search process, or the communication with the signal is lost then the robot movement is stopped as quickly as possible, while keeping the TCP on the path (soft stop). A user recovery error `ERR_SIGSUPSEARCH` will be generated and can be handled in the error handler.

For persistent variable: If the argument `\Flanks` is omitted, it is only when the value change to `TRUE` that is a valid search hit and a variable supervision will be activated at the beginning of a search process. This means that if persistent variable has the positive value already at the beginning of a search process then the robot movement is stopped as quickly as possible, while keeping the TCP on the path (soft stop). A user recovery error `ERR_PERSSUPSEARCH` will be generated and can be handled in the error handler.

[\PosFlank]

Data type: `switch`

Continues on next page

The positive edge of the signal is valid for a search hit, or the change of the value to TRUE if using a persistent variable.

[`\NegFlank`]

Data type: `switch`

The negative edge of the signal is valid for a search hit, or the change of the value to FALSE if using a persistent variable.

[`\HighLevel`]

Data type: `switch`

The same functionality as if not using `\Flanks` switch.

For signal: The positive edge of the signal is valid for a search hit, and a signal supervision will be activated at the beginning of a search process. This means that if the signal has the positive value already at the beginning of a search process or the communication with the signal is lost then the robot movement is stopped as quickly as possible, while keeping the TCP on the path (soft stop). A user recovery error `ERR_SIGSUPSEARCH` will be generated and can be handled in the error handler.

For persistent variable: Only the value change to TRUE is a valid search hit and a variable supervision will be activated at the beginning of a search process. This means that if persistent variable has the positive value already at the beginning of a search process then the robot movement is stopped as quickly as possible, while keeping the TCP on the path (soft stop). A user recovery error `ERR_PERSSUPSEARCH` will be generated and can be handled in the error handler.

[`\LowLevel`]

Data type: `switch`

For signal: The negative edge of the signal is valid for a search hit, and a signal supervision will be activated at the beginning of a search process. This means that if the signal has value 0 already at the beginning of a search process or the communication with the signal is lost then the robot movement is stopped as quickly as possible, while keeping the TCP on the path (soft stop). A user recovery error `ERR_SIGSUPSEARCH` will be generated and can be handled in the error handler.

For persistent variable: Only the value change to FALSE is a valid search hit and a variable supervision will be activated at the beginning of a search process. This means that if persistent variable has the value FALSE already at the beginning of a search process then the robot movement is stopped as quickly as possible, while keeping the TCP on the path (soft stop). A user recovery error `ERR_PERSSUPSEARCH` will be generated and can be handled in the error handler.

`SearchPoint`

Data type: `robtarget`

The position of the TCP and external axes when the search signal has been triggered. The position is specified in the outermost coordinate system taking the specified tool, work object, and active `ProgDisp/ExtOffs` coordinate system into consideration.

`CirPoint`

Data type: `robtarget`

Continues on next page

1 Instructions

1.232 SearchC - Searches circularly using the robot

RobotWare Base

Continued

The circle point of the robot. See the instruction `MoveC` for a more detailed description of circular movement. The circle point is defined as a named position or stored directly in the instruction (marked with an * in the instruction).

ToPoint

Data type: `robtarget`

The destination point of the robot and external axes. It is defined as a named position or stored directly in the instruction (marked with an * in the instruction). `SearchC` always uses a stop point as zone data for the destination.

[\ID]

Synchronization id

Data type: `identno`

The argument [\ID] is mandatory in the MultiMove systems, if the movement is synchronized or coordinated synchronized. This argument is not allowed in any other case. The specified id number must be the same in all the cooperating program tasks. By using the id number the movements are not mixed up at the runtime.

Speed

Data type: `speeddata`

The speed data that applies to movements. Speed data defines the velocity of the tool center point, the external axes and the tool reorientation.

[\V]

Velocity

Data type: `num`

This argument is used to specify the velocity of the TCP in mm/s directly in the instruction. It is then substituted for the corresponding velocity specified in the speed data.

[\T]

Time

Data type: `num`

This argument is used to specify the total time in seconds during which the robot moves. It is substituted for the corresponding speed data. The speed data is computed under the assumption that the speed is constant during the movement. If the robot cannot keep this speed during the whole movement, for example, when the movement starts from a finepoint or ends in a finepoint, the actual movement time will be larger than the programmed time.

Tool

Data type: `tooldata`

The tool in use when the robot moves. The tool center point is the point that is moved to the specified destination position.

[\WObj]

Work Object

Continues on next page

Data type: wobjdata

The work object (coordinate system) to which the robot positions in the instruction are related.

This argument can be omitted and if so then the position is related to the world coordinate system. If, on the other hand, a stationary TCP or coordinated external axes are used then this argument must be specified for a linear movement relative to the work object to be performed.

[\Corr]

Correction

Data type: switch

When this argument is present the correction data written to a corrections entry by the instruction `CorrWrite` will be added to the path and destination position.

The RobotWare option *Path Offset* is required when using this argument.

[\TLoad]

Total load

Data type: loaddata

The `\TLoad` argument describes the total load used in the movement. The total load is the tool load together with the payload that the tool is carrying. If the `\TLoad` argument is used, then the `loaddata` in the current `tooldata` is not considered.

If the `\TLoad` argument is set to `load0`, then the `\TLoad` argument is not considered and the `loaddata` in the current `tooldata` is used instead.

To be able to use the `\TLoad` argument it is necessary to set the value of the system parameter `ModalPayloadMode` to 0. If `ModalPayloadMode` is set to 0, it is no longer possible to use the instruction `GripLoad`.

The total load can be identified with the service routine `LoadIdentify`. If the system parameter `ModalPayloadMode` is set to 0, the operator has the possibility to copy the `loaddata` from the tool to an existing or new `loaddata` persistent variable when running the service routine.

It is possible to test run the program without any payload by using a digital input signal connected to the system input `SimMode` (Simulated Mode). If the digital input signal is set to 1, the `loaddata` in the optional argument `\TLoad` is not considered, and the `loaddata` in the current `tooldata` is used instead.



Note

The default functionality to handle payload is to use the instruction `GripLoad`. Therefore the default value of the system parameter `ModalPayloadMode` is 1.

Program execution

See the instruction `MoveC` for information about circular movement.

The movement is always ended with a stop point, i.e. the robot stops at the destination point.

Continues on next page

1 Instructions

1.232 SearchC - Searches circularly using the robot

RobotWare Base

Continued

When a flying search is used, i.e. the `\Sup` argument is specified or none switch at all is specified, the robot movement always continues to the programmed destination point. When a search is made using the switch `\Stop`, `\PStop`, or `\SStop` the robot movement stops when the first search hit is detected.

The `SearchC` instruction returns the position of the TCP when the value of the digital signal or persistent variable changes to the requested one, as illustrated in figure below.

The figure shows how flank-triggered signal detection is used (the position is stored when the signal is changed the first time only).

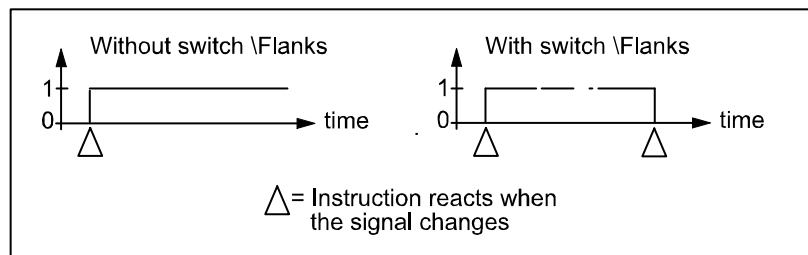

xx0500002237

Error handling

The following recoverable errors are generated and can be handled in an error handler. The system variable `ERRNO` will be set to:

Name	Cause of error
<code>ERR_NO_ALIASIO_DEF</code>	The signal variable is a variable declared in RAPID. It has not been connected to an I/O signal defined in the I/O configuration with instruction <code>AliasIO</code> .
<code>ERR_WHLSEARCH</code>	<ul style="list-style-type: none">No signal detection occurred.More than one signal detection occurred – this occurs only if the <code>\Sup</code> argument is used.
<code>ERR_SIGSUPSEARCH</code>	The signal has already a positive value at the beginning of the search process or the communication with the signal is lost. This occurs only if the <code>\Flanks</code> argument is omitted.
<code>ERR_PERSSUPSEARCH</code>	The persistent variable is already TRUE at the beginning of the search process. This occurs only if the <code>\Flanks</code> argument is omitted.

Errors can be handled in different ways depending on the selected running mode:

- Continuous forward / Instruction forward / `ERR_WHLSEARCH`:** No position is returned and the movement always continues to the programmed destination point. The system variable `ERRNO` is set to `ERR_WHLSEARCH` and the error can be handled in the error handler of the routine.
- Continuous forward / Instruction forward / `ERR_SIGSUPSEARCH` and `ERR_PERSSUPSEARCH`:** No position is returned and the movement always stops as quickly as possible at the beginning of the search path. The system variable `ERRNO` is set to `ERR_SIGSUPSEARCH` or `ERR_PERSSUPSEARCH` depending on used argument (signal or persistent variable), and the error can be handled in the error handler of the routine.

Continues on next page

- **Instruction backward:** During backward execution the instruction carries out the movement without any supervision.

More examples

More examples of how to use the instruction `SearchC` are illustrated below.

Example 1

```
SearchC \Sup, dil\Flanks, sp, cirpoint, p10, v100, probe;
```

The TCP of the `probe` is moved circularly towards the position `p10`. When the value of the signal `dil` changes to active or passive the position is stored in `sp`. If the value of the signal changes twice then program generates an error.

Limitations

General limitations according to instruction `MoveC`.

`SearchC` cannot be executed in an UNDO handler or RAPID routine connected to any of the following special system events: PowerOn, Stop, QStop, Restart, Reset or Step.

Zone data for the positioning instruction that precedes `SearchC` must be used carefully. The recommendation is to use `z0`, or a small zone that still gives a smooth movement. The start of the search, i.e. when the I/O signal is ready to react, is not, in this case, the programmed destination point of the previous positioning instruction but a point along the real robot path. The figure below illustrates an example of something that may go wrong when zone data other than `fine` is used.

The instruction `SearchC` should never be restarted after the circle point has been passed. Otherwise the robot will not take the programmed path (positioning around the circular path in another direction compared to that which is programmed).

The figure shows how a match is made on the wrong side of the object because the wrong zone data was used.

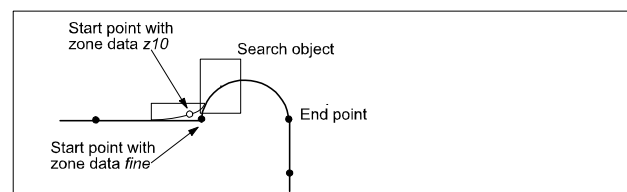

xx0500002238

Continues on next page

1 Instructions

1.232 SearchC - Searches circularly using the robot

RobotWare Base

Continued



WARNING

Limitations for searching if coordinated synchronized movements:

- If using `SearchL`, `SearchC` or `SearchExtJ` for one program task and some other move instruction in other program task, it is only possible to use flying search with switch `\Sup`. Besides that, only possible to do error recovery with `TRYNEXT`.
- It's possible to use all searching functionality, if using some of the instructions `SearchL`, `SearchC` or `SearchExtJ` in all involved program tasks with coordinated synchronized movements and generate search hit from same digital input signal. This will generate search hit synchronously in all search instructions. Any error recovery must also be the same in all involved program tasks.

While searching is active, it isn't possible to store current path with instruction `StorePath`.

Repetition accuracy for search hit position with TCP speed 20 - 1000 mm/s 0.1 - 0.3 mm.

Typical stop distance using a search velocity of 50 mm/s:

- without TCP on path (switch `\Stop`) 1-3 mm
- with TCP on path (switch `\PStop`) 15-25 mm
- with TCP near path (switch `\SStop`) 4-8 mm

Limitations for searching on a conveyor:

- a search will stop the robot when hit or if the search fails, so make the search in the same direction as the conveyor moves and continue after the search-stop with a move to a safe position. Use error handling to move to a safe position when search fails.
- the repetition accuracy for the search hit position will be poorer when searching on a conveyor and depends on the speed of the conveyor and how stabil the speed is.

Syntax

```
SearchC
  ['\ Stop ',''] | ['\ PStop ',''] | ['\ SStop ',''] | ['\ Sup
    ','']
  [Signal':=' ] <variable (VAR) of signaldi>|
  [PersBool ':=' ] <persistent (PERS) of bool>
  ['\ Flanks] |
  ['\ PosFlank] |
  ['\ NegFlank] |
  ['\ HighLevel] |
  ['\ LowLevel] ',''
  [SearchPoint ':=' ] <var or pers (INOUT) of robtarg>',''
  [CirPoint ':=' ] <expression (IN) of robtarg>',''
  [ToPoint ':=' ] <expression (IN) of robtarg>',''
  ['\ ID ':=' ] <expression (IN) of identno>',''
  [Speed':=' ] <expression (IN) of speeddata>
```

Continues on next page

```
[ '\ ' V ':=' <expression (IN) of num> ] |
[ '\ ' T ':=' <expression (IN) of num> ] ', '
[ Tool ':=' ] <persistent (PERS) of tooldata>
[ '\ ' WObj ':=' <persistent (PERS) of wobjdata> ]
[ '\ ' Corr ]
[ '\ ' TLoad ':=' <persistent (PERS) of loaddata> ]';'
```

Related information

For information about	See
Linear searches	SearchL - Searches linearly using the robot on page 676
Writes to a corrections entry	CorrWrite - Writes to a correction generator on page 180
Moves the robot circularly	MoveC - Moves the robot circularly on page 402
Circular movement	<i>Technical reference manual - RAPID Overview</i>
Definition of load	loaddata - Load data on page 1682
Definition of velocity	speeddata - Speed data on page 1751
Definition of tools	tooldata - Tool data on page 1776
Definition of work objects	wobjdata - Work object data on page 1803
Using error handlers	<i>Technical reference manual - RAPID Overview</i>
Motion in general	<i>Technical reference manual - RAPID Overview</i>
Example of how to use TLoad, Total Load.	MoveL - Moves the robot linearly on page 458
Defining the payload for a robot	GripLoad - Defines the payload for a robot on page 243
LoadIdentify, load identification service routine	<i>Operating manual - IRC5 with FlexPendant</i>
System input signal <i>SimMode</i> for running the robot in simulated mode without payload.	<i>Technical reference manual - System parameters</i>
System parameter <i>ModalPayload-Mode</i> for activating and deactivating payload.	<i>Technical reference manual - System parameters</i>
<i>Path Offset</i>	<i>Application manual - Controller software IRC5</i>

1 Instructions

1.233 SearchExtJ - Search with one or several mechanical units without TCP *RobotWare Base*

1.233 SearchExtJ - Search with one or several mechanical units without TCP

Usage

`SearchExtJ` (*Search External Joints*) is used to search for an external axes position when moving only linear or rotating external axes. The external axes can belong to one or several mechanical units without TCP.

During the movement the robot supervises a digital input signal or a persistent variable. When the value of the signal or persistent variable changes to the requested one the robot immediately reads the current position.

This instruction can only be used if:

- The actual program task is defined as a Motion Task
- The task controls one or several mechanical units without TCP

When using search instructions it is important to configure the I/O system to have a very short time delay from setting the physical signal until the system gets the information about the setting (use I/O device with interrupt control, not poll control). How to do this can differ between fieldbuses. If using DeviceNet, the ABB units DSQC 651 (AD Combi I/O) and DSQC 652 (Digital I/O) will give a short time delay since they are using the connection type Change of State. If using other fieldbuses, ensure that the network is properly configured to get the correct conditions.

Basic examples

The following examples illustrate the instruction `SearchExtJ`:

See also [More examples on page 674](#).

Example 1

```
SearchExtJ di1, searchp, jpos10, vrot20;
```

The mec. unit with rotational axes is moved towards the position `jpos10` at a speed of `vrot20`. When the value of the signal `di1` changes to active, the position is stored in `searchp`.

Example 2

```
SearchExJ \Stop, di2, posx, jpos20, vlin50;
```

The mec. unit with linear axis is moved towards the position `jpos20`. When the value of the signal `di2` changes to active, the position is stored in `posx` and the ongoing movement is stopped immediately.

Example 3

```
PERS bool mypers:=FALSE;  
...  
SearchExJ \Stop, di2, posx, jpos20, vlin50;
```

The mec. unit with linear axis is moved towards the position `jpos20`. When the value of the persistent variable `mypers` changes to TRUE, the position is stored in `posx` and the ongoing movement is stopped immediately.

Arguments

```
SearchExtJ [\Stop] | [\PStop] | [\SStop] | [\Sup] Signal | PersBool  
[\Flanks] | [\PosFlank] | [\NegFlank] | [\HighLevel] |
```

Continues on next page

1.233 SearchExtJ - Search with one or several mechanical units without TCP

RobotWare Base
Continued

```
[ \LowLevel] SearchJointPos ToJointPos [ \ID] [ \UseEOffs] Speed
[ \T]
```

[\Stop]

Stiff Stop

Data type: *switch*

The movement is stopped as quickly as possible with hard stop when the value of the search signal changes to active or when the persistent variable value changes to TRUE. The external axes are moved a small distance before they stop and are not moved back to the searched position, i.e. to the position where the signal changed.

[\PStop]

Path Stop

Data type: *switch*

The movement is stopped with path stop (Program Stop) when the value of the search signal changes to active or the persistent variable value changes to TRUE. The external axes are moved a rather long distance before they stop and are not moved back to the searched position, i.e. to the position where the signal changed.

[\SStop]

Soft Stop

Data type: *switch*

The movement is stopped as quickly as possible with fast soft stop when the value of the search signal changes to active or the persistent variable value changes to TRUE. The external axes are moved only a small distance before they stop and are not moved back to the searched position, i.e. to the position where the signal changed.

Stop is faster compare to SStop. SStop is faster compare to PStop.

[\Sup]

Supervision

Data type: *switch*

The search instruction is sensitive to signal activation or persistent variable value change during the complete movement (flying search), i.e. even after the first signal change or persistent variable change has been reported. If more than one match occurs during a search then a recoverable error is generated with the robot in the ToPoint.

If the arguments \Stop, \PStop, \SStop, and \Sup are omitted (no switch used at all):

- The movement continues (flying search) to the position specified in the ToJointPos argument (same as with argument \Sup)
- An error is reported for one search hit but is not reported for more than one search hit (the first search hit is returned as the SearchJointPos)

Signal

Data type: *signal*

Continues on next page

1 Instructions

1.233 SearchExtJ - Search with one or several mechanical units without TCP

RobotWare Base

Continued

The name of the signal to supervise.

PersBool

Data type: bool

The persistent variable to supervise.

[\Flanks]

Data type: switch

The positive and the negative edge of the signal is valid for a search hit. If using argument PersBool it is the value change of the variable that is valid for a search hit.

For signal: If the argument \Flanks is omitted, only the positive edge of the signal is valid for a search hit and a signal supervision will be activated at the beginning of a search process. This means that if the signal has the positive value already at the beginning of a search process, or the communication with the signal is lost then the movement is stopped as quickly as possible. A user recovery error ERR_SIGSUPSEARCH will be generated and can be handled in the error handler.

For persistent variable: If the argument \Flanks is omitted, it is only when the value change to TRUE that is a valid search hit and a variable supervision will be activated at the beginning of a search process. This means that if persistent variable has the positive value already at the beginning of a search process then the movement is stopped as quickly as possible. A user recovery error ERR_PERSSUPSEARCH will be generated and can be handled in the error handler.

[\PosFlank]

Data type: switch

The positive edge of the signal is valid for a search hit, or the change of the value to TRUE if using a persistent variable.

[\NegFlank]

Data type: switch

The negative edge of the signal is valid for a search hit, or the change of the value to FALSE if using a persistent variable.

[\HighLevel]

Data type: switch

The same functionality as if not using \Flanks switch.

For signal: The positive edge of the signal is valid for a search hit, and a signal supervision will be activated at the beginning of a search process. This means that if the signal has the positive value already at the beginning of a search process or the communication with the signal is lost then the movement is stopped as quickly as possible. A user recovery error ERR_SIGSUPSEARCH will be generated and can be handled in the error handler.

For persistent variable: Only the value change to TRUE is a valid search hit and a variable supervision will be activated at the beginning of a search process. This means that if persistent variable has the positive value already at the beginning of a search process then the movement is stopped as quickly as possible. A user

Continues on next page

1.233 SearchExtJ - Search with one or several mechanical units without TCP RobotWare Base Continued

recovery error `ERR_PERSSUPSEARCH` will be generated and can be handled in the error handler.

[\LowLevel]

Data type: `switch`

For signal: The negative edge of the signal is valid for a search hit, and a signal supervision will be activated at the beginning of a search process. This means that if the signal has value 0 already at the beginning of a search process or the communication with the signal is lost then the movement is stopped as quickly as possible. A user recovery error `ERR_SIGSUPSEARCH` will be generated and can be handled in the error handler.

For persistent variable: Only the value change to `FALSE` is a valid search hit and a variable supervision will be activated at the beginning of a search process. This means that if persistent variable has the value `FALSE` already at the beginning of a search process then the movement is stopped as quickly as possible. A user recovery error `ERR_PERSSUPSEARCH` will be generated and can be handled in the error handler.

SearchJointPos

Data type: `jointtarget`

The position of the external axes when the search signal has been triggered. The position takes any active `ExtOffs` into consideration.

ToJointPos

Data type: `jointtarget`

The destination point for the external axes. It is defined as a named position or stored directly in the instruction (marked with an * in the instruction). `SearchExtJ` always uses a stop point as zone data for the destination.

[\ID]

Synchronization id

Data type: `identno`

The argument [\ID] is mandatory in the MultiMove systems, if the movement is synchronized or coordinated synchronized. This argument is not allowed in any other case. The specified id number must be the same in all the cooperating program tasks. By using the id number the movements are not mixed up at the runtime.

[\UseEOffs]

Use External Offset

Data type: `switch`

The offset for external axes, setup by instruction `EOffsSet`, is activated for `SearchExtJ` instruction when the argument `UseEOffs` is used. See instruction `EOffsSet` for more information about external offset.

Speed

Data type: `speeddata`

Continues on next page

1 Instructions

1.233 SearchExtJ - Search with one or several mechanical units without TCP

RobotWare Base

Continued

The speed data that applies to movements. Speed data defines the velocity of the linear or rotating external axis.

[\T]

Time

Data type: num

This argument is used to specify the total time in seconds during which the mec. units move. It is then substituted for the corresponding speed data.

This argument is used to specify the total time in seconds during which the mechanical unit moves. It is substituted for the corresponding speed data. The speed data is computed under the assumption that the speed is constant during the movement. If the mechanical unit cannot keep this speed during the whole movement, for example, when the movement starts from a finepoint or ends in a finepoint, the actual movement time will be larger than the programmed time.

Program execution

See the instruction `MoveExtJ` for information about movement of mechanical units without TCP.

The movement always ends with a stop point, i.e. the external axes stop at the destination point. If a flying search is used, that is, the `\Sup` argument is specified or no switch is specified the movement always continues to the programmed destination point. If a search is made using the switch `\Stop`, `\PStop` or `\SStop`, the movement stops when the first search hit is detected.

The `SearchExtJ` instruction stores the position of the external axes when the value of the digital signal or persistent variable changes to the requested one, as illustrated in figure below.

The figure shows how flank-triggered signal detection is used (the position is only stored when the signal is changed the first time).

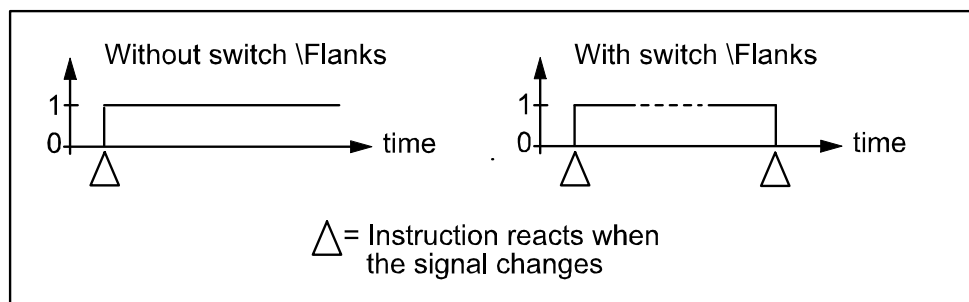

xx0500002243

Error handling

The following recoverable errors are generated and can be handled in an error handler. The system variable `ERRNO` will be set to:

Name	Cause of error
<code>ERR_NO_ALIASIO_DEF</code>	The signal variable is a variable declared in RAPID. It has not been connected to an I/O signal defined in the I/O configuration with instruction <code>AliasIO</code> .

Continues on next page

1.233 SearchExtJ - Search with one or several mechanical units without TCP

RobotWare Base
Continued

Name	Cause of error
ERR_WHLSEARCH	<ul style="list-style-type: none"> No signal detection occurred. More than one signal detection occurred – this occurs only if the \Sup argument is used.
ERR_SIGSUPSEARCH	<p>The signal has already a positive value at the beginning of the search process or the communication with the signal is lost.</p> <p>This occurs only if the \Flanks argument is omitted.</p>
ERR_PERSSUPSEARCH	<p>The persistent variable is already TRUE at the beginning of the search process.</p> <p>This occurs only if the \Flanks argument is omitted.</p>

Errors can be handled in different ways depending on the selected running mode:

- Continuous forward / Instruction forward / ERR_WHLSEARCH:** No position is returned and the movement always continues to the programmed destination point. The system variable `ERRNO` is set to `ERR_WHLSEARCH` and the error can be handled in the error handler of the routine.
- Continuous forward / Instruction forward / ERR_SIGSUPSEARCH and ERR_PERSSUPSEARCH:** No position is returned and the movement always stops as quickly as possible at the beginning of the search path. The system variable `ERRNO` is set to `ERR_SIGSUPSEARCH` or `ERR_PERSSUPSEARCH` depending on used argument (signal or persistent variable), and the error can be handled in the error handler of the routine.
- Instruction backward:** During backward execution the instruction carries out the movement without any supervision.

Example

```

VAR num fk;
...
MoveExtJ jpos10, vrot100, fine;
SearchExtJ \Stop, dil, sp, jpos20, vrot5;
...
ERROR
  IF ERRNO=ERR_WHLSEARCH THEN
    StorePath;
    MoveExtJ jpos10, vrot50, fine;
    RestoPath;
    ClearPath;
    StartMove;
    RETRY;
  ELSEIF ERRNO=ERR_SIGSUPSEARCH THEN
    TPWrite "The signal of the SearchExtJ instruction is already
      high!";
    TPReadFK fk,"Try again after manual reset of signal ?","YES",
      stEmpty, stEmpty, stEmpty, "NO";
    IF fk = 1 THEN
      StorePath;
      MoveExtJ jpos10, vrot50, fine;
      RestoPath;
      ClearPath;

```

Continues on next page

1 Instructions

1.233 SearchExtJ - Search with one or several mechanical units without TCP

RobotWare Base

Continued

```
        StartMove;  
        RETRY;  
    ELSE  
        Stop;  
    ENDF  
ENDIF
```

If the signal is already active at the beginning of the search process or the communication with the signal is lost, a user dialog will be activated (TPReadFK . . . ;). Reset the signal and push YES on the user dialog and the mec. unit moves back to jpos10 and tries once more. Otherwise program execution will stop.

If the signal is passive at the beginning of the search process, the mec. unit searches from position jpos10 to jpos20. If no signal detection occurs, the robot moves back to jpos10 and tries once more.

More examples

More examples of how to use the instruction SearchExtJ are illustrated below.

Example 1

```
SearchExtJ \Sup, dil\Flanks, searchp, jpos10, vrot20;
```

The mec. unit is moved towards the position jpos10. When the value of the signal dil changes to active or passive, the position is stored in searchp. If the value of the signal changes twice, the program generates an error after the search process is finished.

Example 2

```
SearchExtJ \Stop, dil, sp, jpos20, vlin50;  
MoveExtJ sp, vlin50, fine \Inpos := inpos50;
```

A check on the signal dil will be made at the beginning of the search process and if the signal already has a positive value or the communication with the signal is lost, the movement stops. Otherwise the mec. unit is moved towards the position jpos20. When the value of the signal dil changes to active, the position is stored in sp. The mec. unit is moved back to this point using an accurately defined stop point.

Limitations

SearchExtJ cannot be executed in an UNDO handler or RAPID routine connected to any of the following special system events: PowerOn, Stop, QStop, Restart, Reset or Step.

Limitations for searching if coordinated synchronized movements:

- If using SearchL, SearchC, or SearchExtJ for one program task and some other move instruction in another program task, it is only possible to use flying search with switch \Sup. Besides that, it is only possible to do error recovery with TRYNEXT.
- It is possible to use all searching functions if using some of the instructions SearchL, SearchC or SearchExtJ in all involved program tasks with coordinated synchronized movements and generate search hits from the same digital input signal. This will generate search hits synchronously in all

Continues on next page

1.233 SearchExtJ - Search with one or several mechanical units without TCP

RobotWare Base

Continued

search instructions. Any error recovery must also be the same in all involved program tasks.

- While searching is active, it isn't possible to store current path with instruction StorePath.

Syntax

```
SearchExtJ
  ['\ ' Stop ','] | ['\ ' PStop ','] | ['\ ' SStop ','] | ['\ ' Sup
    ',']
  [Signal ':=' ] <variable (VAR) of signaldi> |
  [PersBool ':=' ] <persistent (PERS) of bool>
  ['\ ' Flanks ] |
  ['\ ' PosFlank ] |
  ['\ ' NegFlank ] |
  ['\ ' HighLevel ] |
  ['\ ' LowLevel ] ', '
  [SearchJointPos ':=' ] <var or pers (INOUT) of jointtarget> ', '
  [ToJointPos ':=' ] <expression (IN) of jointtarget >
  ['\ ' ID ':=' <expression (IN) of identno >]', '
  ['\ ' UseEOffs ', ' ]
  [Speed ':=' ] <expression (IN) of speeddata>
  ['\ ' T ':=' <expression (IN) of num> ]';'
```

Related information

For information about	See
Move mec. units without TCP	MoveExtJ - Move one or several mechanical units without TCP on page 430
Definition of jointtarget	jointtarget - Joint position data on page 1679
Definition of velocity	speeddata - Speed data on page 1751
Using error handlers	<i>Technical reference manual - RAPID Overview</i>
Motion in general	<i>Technical reference manual - RAPID Overview</i>

1 Instructions

1.234 SearchL - Searches linearly using the robot *RobotWare Base*

1.234 SearchL - Searches linearly using the robot

Usage

`SearchL` (*Search Linear*) is used to search for a position when moving the tool center point (TCP) linearly.

During the movement the robot supervises a digital input signal or a persistent variable. When the value of the signal or persistent variable changes to the requested one the robot immediately reads the current position.

This instruction can typically be used when the tool held by the robot is a probe for surface detection. Using the `SearchL` instruction the outline coordinates of a work object can be obtained.

This instruction can only be used in the main task `T_ROB1` or, if in a *MultiMove* system, in Motion tasks.

When using search instructions it is important to configure the I/O system to have a very short time from setting the physical signal to the system to getting the information regarding the setting (use I/O device with interrupt control, not poll control). How to do this can differ between fieldbuses. If using DeviceNet the ABB units (local I/O) will give short times since they are using connection type *Change of State*. If using other fieldbuses ensure that you configure the network in a proper way to get right conditions.

Basic examples

The following examples illustrate the instruction `SearchL`:

See also [More examples on page 683](#).

Example 1

```
SearchL di1, sp, p10, v100, probe;
```

The TCP of the `probe` is moved linearly towards the position `p10` at a speed of `v100`. When the value of the signal `di1` changes to active the position is stored in `sp`.

Example 2

```
SearchL \Stop, di2, sp, p10, v100, probe;
```

The TCP of the `probe` is moved linearly towards the position `p10`. When the value of the signal `di2` changes to active the position is stored in `sp` and the robot stops immediately.

Example 3

```
PERS bool mypers:=FALSE;  
...  
SearchL mypers, sp, p10, v100, probe;
```

The TCP of the `probe` is moved linearly towards the position `p10` at a speed of `v100`. When the value of the persistent variable `mypers` changes to `TRUE` the position is stored in `sp`.

Continues on next page

Arguments

```
SearchL [\Stop] | [\PStop] | [\SStop] | [\Sup] Signal | PersBool
[\Flanks] | [\PosFlank] | [\NegFlank] | [\HighLevel] |
[\LowLevel] SearchPoint ToPoint [\ID] Speed [\V] | [\T] Tool
[\WObj] [\Corr] [\TLoad]
```

[\Stop]

Stiff StopData type: *switch*

The robot movement is stopped as quickly as possible without keeping the TCP on the path (hard stop) when the value of the search signal changes to active or the persistent variable value changes to TRUE. The robot is moved a small distance before it stops and is not moved back to the searched position, i.e. to the position where the signal or persistent value changed.

Test first with a slow speed, for example <100 mm/s, and then gradually increase the speed to the desired value.

**WARNING**

Stopping the search with a stiff stop (switch `\Stop`) is only allowed if the TCP-speed is lower than 100 mm/s. A stiff stop at higher speed can cause some axes to move in unpredictable directions.

**Note**

For a YuMi robot, the maximum speed for searching with stiff stop is 1000 mm/s.

[\PStop]

Path StopData type: *switch*

The robot movement is stopped as quickly as possible while keeping the TCP on the path (soft stop) when the value of the search signal changes to active or the persistent variable value changes to TRUE. The robot is moved a distance before it stops and is not moved back to the searched position, i.e. to the position where the signal or persistent value changed.

[\SStop]

Soft StopData type: *switch*

The robot movement is stopped as quickly as possible while keeping the TCP close to or on the path (soft stop) when the value of the search signal changes to active or the persistent variable value changes to TRUE. The robot is only moved a small distance before it stops and is not moved back to the searched position, that is, to the position where the signal or persistent variable changed. `SStop` is faster than `PStop`. But when the robot is running faster than 100 mm/s it stops in the direction of the tangent of the movement which causes it to marginally slide off the path.

Continues on next page

1 Instructions

1.234 SearchL - Searches linearly using the robot

RobotWare Base

Continued

[\Sup]

Supervision

Data type: `switch`

The search instruction is sensitive to signal activation or persistent variable value change during the complete movement (flying search), i.e. even after the first signal change or persistent variable change has been reported. If more than one match occurs during a search then a recoverable error is generated with the robot in the `ToPoint`.

If the arguments `\Stop`, `\PStop`, `\SStop`, and `\Sup` are omitted (no switch used at all):

- the movement continues (flying search) to the position specified in the `ToPoint` argument (same as with argument `\Sup`)
- error is reported for none search hit but is not reported for more than one search hit (first search hit is returned as the `SearchPoint`)

Signal

Data type: `signal`

The name of the signal to supervise.

PersBool

Data type: `bool`

The persistent variable to supervise.

[\Flanks]

Data type: `switch`

The positive and the negative edge of the signal is valid for a search hit. If using argument `PersBool` it is the value change of the variable that is valid for a search hit.

For signal: If the argument `\Flanks` is omitted, only the positive edge of the signal is valid for a search hit and a signal supervision will be activated at the beginning of a search process. This means that if the signal has the positive value already at the beginning of a search process, or the communication with the signal is lost then the robot movement is stopped as quickly as possible, while keeping the TCP on the path (soft stop). A user recovery error `ERR_SIGSUPSEARCH` will be generated and can be handled in the error handler.

For persistent variable: If the argument `\Flanks` is omitted, it is only when the value change to `TRUE` that is a valid search hit and a variable supervision will be activated at the beginning of a search process. This means that if persistent variable has the positive value already at the beginning of a search process then the robot movement is stopped as quickly as possible, while keeping the TCP on the path (soft stop). A user recovery error `ERR_PERSSUPSEARCH` will be generated and can be handled in the error handler.

[\PosFlank]

Data type: `switch`

Continues on next page

The positive edge of the signal is valid for a search hit, or the change of the value to TRUE if using a persistent variable.

[`\NegFlank`]

Data type: `switch`

The negative edge of the signal is valid for a search hit, or the change of the value to FALSE if using a persistent variable.

[`\HighLevel`]

Data type: `switch`

The same functionality as if not using `\Flanks` switch.

For signal: The positive edge of the signal is valid for a search hit, and a signal supervision will be activated at the beginning of a search process. This means that if the signal has the positive value already at the beginning of a search process or the communication with the signal is lost then the robot movement is stopped as quickly as possible, while keeping the TCP on the path (soft stop). A user recovery error `ERR_SIGSUPSEARCH` will be generated and can be handled in the error handler.

For persistent variable: Only the value change to TRUE is a valid search hit and a variable supervision will be activated at the beginning of a search process. This means that if persistent variable has the positive value already at the beginning of a search process then the robot movement is stopped as quickly as possible, while keeping the TCP on the path (soft stop). A user recovery error `ERR_PERSSUPSEARCH` will be generated and can be handled in the error handler.

[`\LowLevel`]

Data type: `switch`

For signal: The negative edge of the signal is valid for a search hit, and a signal supervision will be activated at the beginning of a search process. This means that if the signal has value 0 already at the beginning of a search process or the communication with the signal is lost then the robot movement is stopped as quickly as possible, while keeping the TCP on the path (soft stop). A user recovery error `ERR_SIGSUPSEARCH` will be generated and can be handled in the error handler.

For persistent variable: Only the value change to FALSE is a valid search hit and a variable supervision will be activated at the beginning of a search process. This means that if persistent variable has the value FALSE already at the beginning of a search process then the robot movement is stopped as quickly as possible, while keeping the TCP on the path (soft stop). A user recovery error `ERR_PERSSUPSEARCH` will be generated and can be handled in the error handler.

`SearchPoint`

Data type: `robtarget`

The position of the TCP and external axes when the search signal has been triggered. The position is specified in the outermost coordinate system taking the specified tool, work object, and active `ProgDisp/ExtOffs` coordinate system into consideration.

`ToPoint`

Data type: `robtarget`

Continues on next page

1 Instructions

1.234 SearchL - Searches linearly using the robot

RobotWare Base

Continued

The destination point of the robot and external axes. It is defined as a named position or stored directly in the instruction (marked with an * in the instruction). SearchL always uses a stop point as zone data for the destination.

[\ID]

Synchronization id

Data type: identno

The argument [\ID] is mandatory in the MultiMove systems, if the movement is synchronized or coordinated synchronized. This argument is not allowed in any other case. The specified id number must be the same in all the cooperating program tasks. By using the id number the movements are not mixed up at the runtime.

Speed

Data type: speeddata

The speed data that applies to movements. Speed data defines the velocity of the tool center point, the external axes, and the tool reorientation.

[\V]

Velocity

Data type: num

This argument is used to specify the velocity of the TCP in mm/s directly in the instruction. It is then substituted for the corresponding velocity specified in the speed data.

[\T]

Time

Data type: num

This argument is used to specify the total time in seconds during which the robot moves. It is substituted for the corresponding speed data. The speed data is computed under the assumption that the speed is constant during the movement. If the robot cannot keep this speed during the whole movement, for example, when the movement starts from a finepoint or ends in a finepoint, the actual movement time will be larger than the programmed time.

Tool

Data type: tooldata

The tool in use when the robot moves. The tool center point is the point that is moved to the specified destination position.

[\WObj]

Work Object

Data type: wobjdata

The work object (coordinate system) to which the robot position in the instruction is related.

This argument can be omitted and if so then the position is related to the world coordinate system. If, on the other hand, a stationary TCP or coordinated external

Continues on next page

axes are used then this argument must be specified for a linear movement relative to the work object to be performed.

[\Corr]

Correction

Data type: `switch`

Correction data written to a corrections entry by the instruction `CorrWrite` will be added to the path and destination position if this argument is present.

The RobotWare option *Path Offset* is required when using this argument.

[\TLoad]

Total load

Data type: `loaddata`

The `\TLoad` argument describes the total load used in the movement. The total load is the tool load together with the payload that the tool is carrying. If the `\TLoad` argument is used, then the `loaddata` in the current `tooldata` is not considered.

If the `\TLoad` argument is set to `load0`, then the `\TLoad` argument is not considered and the `loaddata` in the current `tooldata` is used instead.

To be able to use the `\TLoad` argument it is necessary to set the value of the system parameter `ModalPayLoadMode` to 0. If `ModalPayLoadMode` is set to 0, it is no longer possible to use the instruction `GripLoad`.

The total load can be identified with the service routine `LoadIdentify`. If the system parameter `ModalPayLoadMode` is set to 0, the operator has the possibility to copy the `loaddata` from the tool to an existing or new `loaddata` persistent variable when running the service routine.

It is possible to test run the program without any payload by using a digital input signal connected to the system input `SimMode` (Simulated Mode). If the digital input signal is set to 1, the `loaddata` in the optional argument `\TLoad` is not considered, and the `loaddata` in the current `tooldata` is used instead.



Note

The default functionality to handle payload is to use the instruction `GripLoad`. Therefore the default value of the system parameter `ModalPayLoadMode` is 1.

Program execution

See the instruction `MoveL` for information about linear movement.

The movement always ends with a stop point, i.e. the robot stops at the destination point. If a flying search is used, i.e. the `\Sup` argument is specified or none switch at all is specified then the robot movement always continues to the programmed destination point. If a search is made using the switch `\Stop`, `\PStop`, or `\SStop` the robot movement stops when the first search hit is detected.

The `SearchL` instruction stores the position of the TCP when the value of the digital signal or persistent variable changes to the requested one, as illustrated in figure below.

Continues on next page

1 Instructions

1.234 SearchL - Searches linearly using the robot

RobotWare Base

Continued

The figure shows how flank-triggered signal detection is used (the position is stored when the signal is changed the first time only).

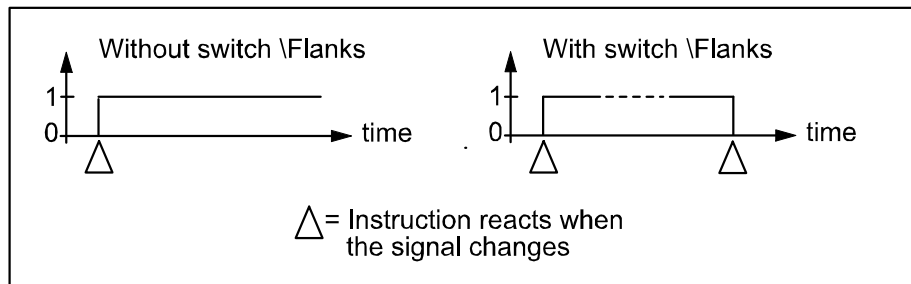

xx0500002243

Error handling

The following recoverable errors are generated and can be handled in an error handler. The system variable `ERRNO` will be set to:

Name	Cause of error
<code>ERR_NO_ALIASIO_DEF</code>	The signal variable is a variable declared in RAPID. It has not been connected to an I/O signal defined in the I/O configuration with instruction <code>AliasIO</code> .
<code>ERR_WHLSEARCH</code>	<ul style="list-style-type: none">No signal detection occurred.More than one signal detection occurred – this occurs only if the <code>\Sup</code> argument is used.
<code>ERR_SIGSUPSEARCH</code>	The signal has already a positive value at the beginning of the search process or the communication with the signal is lost. This occurs only if the <code>\Flanks</code> argument is omitted.
<code>ERR_PERSSUPSEARCH</code>	The persistent variable is already TRUE at the beginning of the search process. This occurs only if the <code>\Flanks</code> argument is omitted.

Errors can be handled in different ways depending on the selected running mode:

- Continuous forward / Instruction forward / `ERR_WHLSEARCH`:** No position is returned and the movement always continues to the programmed destination point. The system variable `ERRNO` is set to `ERR_WHLSEARCH` and the error can be handled in the error handler of the routine.
- Continuous forward / Instruction forward / `ERR_SIGSUPSEARCH` and `ERR_PERSSUPSEARCH`:** No position is returned and the movement always stops as quickly as possible at the beginning of the search path. The system variable `ERRNO` is set to `ERR_SIGSUPSEARCH` or `ERR_PERSSUPSEARCH` depending on used argument (signal or persistent variable), and the error can be handled in the error handler of the routine.
- Instruction backward:** During backward execution the instruction carries out the movement without any supervision.

Example

```
VAR num fk;  
...  
MoveL p10, v100, fine, tool1;
```

Continues on next page

```
SearchL \Stop, dil, sp, p20, v100, tool1;
...
ERROR
  IF ERRNO=ERR_WHLSEARCH THEN
    StorePath;
    MoveL p10, v100, fine, tool1;
    RestoPath;
    ClearPath;
    StartMove;
    RETRY;
  ELSEIF ERRNO=ERR_SIGSUPSEARCH THEN
    TPWrite "The signal of the SearchL instruction is already
      high!";
    TPReadFK fk,"Try again after manual reset of signal ?", "YES",
      stEmpty, stEmpty, stEmpty, "NO";
    IF fk = 1 THEN
      StorePath;
      MoveL p10, v100, fine, tool1;
      RestoPath;
      ClearPath;
      StartMove;
      RETRY;
    ELSE
      Stop;
    ENDIF
  ENDIF
ENDIF
```

If the signal is already active at the beginning of the search process or the communication with the signal is lost then a user dialog will be activated (TPReadFK ...;). Reset the signal and push YES on the user dialog, and the robot moves back to p10 and tries once more. Otherwise program execution will stop.

If the signal is passive at the beginning of the search process then the robot searches from position p10 to p20. If no signal detection occurs then the robot moves back to p10 and tries once more.

More examples

More examples of how to use the instruction SearchL are illustrated below.

Example 1

```
SearchL \Sup, dil \Flanks, sp, p10, v100, probe;
```

The TCP of the probe is moved linearly towards the position p10. When the value of the signal dil changes to active or passive the position is stored in sp. If the value of the signal changes twice then the program generates an error after the search process is finished.

Example 2

```
SearchL \Stop, dil, sp, p10, v100, tool1;
MoveL sp, v100, fine \Inpos := inpos50, tool1;
PDispOn *, tool1;
MoveL p100, v100, z10, tool1;
MoveL p110, v100, z10, tool1;
```

Continues on next page

1 Instructions

1.234 SearchL - Searches linearly using the robot

RobotWare Base

Continued

```
MoveL p120, v100, z10, tool1;  
PDispOff;
```

At the beginning of the search process, a check on the signal `di1` will be done and if the signal already has a positive value or the communication with the signal is lost, the robot stops. Otherwise the TCP of `tool1` is moved linearly towards the position `p10`. When the value of the signal `di1` changes to active, the position is stored in `sp`. The robot is moved back to this point using an accurately defined stop point. Using program displacement, the robot then moves relative to the searched position, `sp`.

Example 3

```
PERS bool MyTrigger:=FALSE;  
...  
SearchL \Stop, MyTrigger, sp, p10, v100, tool1;  
MoveL sp, v100, fine \Inpos := inpos50, tool1;  
PDispOn *, tool1;  
MoveL p100, v100, z10, tool1;  
MoveL p110, v100, z10, tool1;  
MoveL p120, v100, z10, tool1;  
PDispOff;
```

At the beginning of the search process, a check on the persistent variable `MyTrigger` will be done and if the variable already is `TRUE`, the robot stops. Otherwise the TCP of `tool1` is moved linearly towards the position `p10`. When the value of the persistent variable `MyTrigger` changes to `TRUE`, the position is stored in `sp`. The robot is moved back to this point using an accurately defined stop point. Using program displacement, the robot then moves relative to the searched position, `sp`.

Limitations

`SearchL` cannot be executed in an UNDO handler or RAPID routine connected to any of the following special system events: PowerOn, Stop, QStop, Restart, Reset or Step.

Zone data for the positioning instruction that precedes `SearchL` must be used carefully. The start of the search, i.e. when the I/O signal is ready to react, is not, in this case, the programmed destination point of the previous positioning instruction but a point along the real robot path. The figures below illustrate examples of things that may go wrong when zone data other than `fine` is used.

The following figure shows that a match is made on the wrong side of the object because the wrong zone data was used.

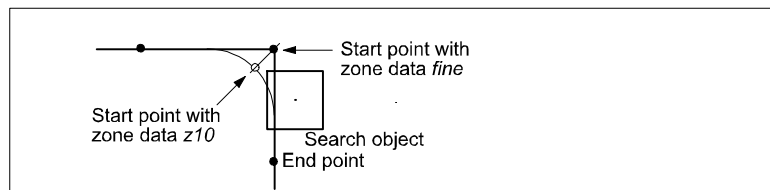

xx0500002244

Continues on next page

The following figure shows that no match was detected because the wrong zone data was used.

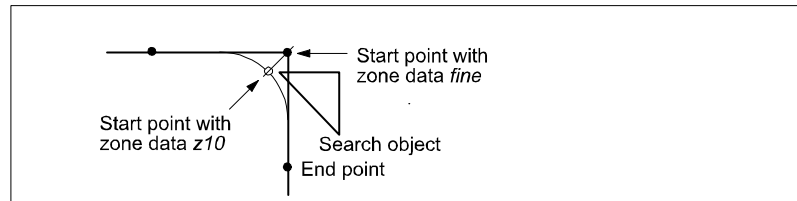

xx0500002245

The following figure shows that no match was detected because the wrong zone data was used.

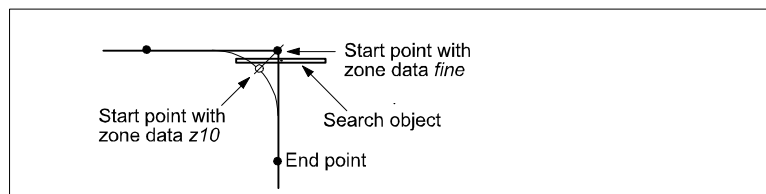

xx0500002246

Limitations for searching if coordinated synchronized movements:

- If using `SearchL`, `SearchC` or `SearchExtJ` for one program task and some other move instruction in other program task, it is only possible to use flying search with switch `\Sup`. Besides that, only possible to do error recovery with `TRYNEXT`.
- It's possible to use all searching functionality, if using some of the instructions `SearchL`, `SearchC` or `SearchExtJ` in all involved program tasks with coordinated synchronized movements and generate search hit from same digital input signal. This will generate search hit synchronously in all search instructions. Any error recovery must also be the same in all involved program tasks.

While searching is active, it isn't allowed to store current path with instruction `StorePath`.

Repetition accuracy for search hit position with TCP speed 20 - 1000 mm/s 0.1 - 0.3 mm.

Typical stop distance using a search velocity of 50 mm/s:

- without TCP on path (switch `\Stop`) 1-3 mm
- with TCP on path (switch `\PStop`) 15-25 mm
- with TCP near path (switch `\SStop`) 4-8 mm

Limitations for searching on a conveyor:

- a search will stop the robot when hit or if the search fails, so make the search in the same direction as the conveyor moves and continue after the search-stop with a move to a safe position. Use error handling to move to a safe position when search fails.

Continues on next page

1 Instructions

1.234 SearchL - Searches linearly using the robot

RobotWare Base

Continued

- the repetition accuracy for the search hit position will be poorer when searching on a conveyor and depends on the speed of the conveyor and how stable the speed is.

Syntax

```
SearchL
  ['\' Stop ',''] | ['\' PStop ',''] | ['\' SStop ',''] | ['\' Sup
    ','']
  [Signal ':=' ] <variable (VAR) of signaldi> |
  [PersBool ':=' ] <persistent (PERS) of bool>
  ['\' Flanks ] |
  ['\' PosFlank ] |
  ['\' NegFlank ] |
  ['\' HighLevel ] |
  ['\' LowLevel ] ','
  [SearchPoint ':=' ] <var or pers (INOUT) of robtarget>','
  [ToPoint ':=' ] <expression (IN) of robtarget>
  ['\' ID ':=' ] <expression (IN) of identno>','
  [Speed ':=' ] <expression (IN) of speeddata>
  ['\' V ':=' ] <expression (IN) of num> ] |
  ['\' T ':=' ] <expression (IN) of num> ]','
  [Tool ':=' ] <persistent (PERS) of tooldata>
  ['\' WObj ':=' ] <persistent (PERS) of wobjdata> ]
  ['\' Corr ]
  ['\' TLoad ':=' ] <persistent (PERS) of loaddata> ]';'
```

Related information

For information about	See
Circular searches	SearchC - Searches circularly using the robot on page 658
Writes to a corrections entry	CorrWrite - Writes to a correction generator on page 180
Moves the robot linearly	MoveL - Moves the robot linearly on page 458
Linear movement	<i>Technical reference manual - RAPID Overview</i>
Definition of load	loaddata - Load data on page 1682
Definition of velocity	speeddata - Speed data on page 1751
Definition of tools	tooldata - Tool data on page 1776
Definition of work objects	wobjdata - Work object data on page 1803
Using error handlers	<i>Technical reference manual - RAPID Overview</i>
Motion in general	<i>Technical reference manual - RAPID Overview</i>
Example of how to use TLoad, Total Load.	MoveL - Moves the robot linearly on page 458
Defining the payload for a robot	GripLoad - Defines the payload for a robot on page 243
LoadIdentify, load identification service routine	<i>Operating manual - IRC5 with FlexPendant</i>

Continues on next page

For information about	See
System input signal <i>SimMode</i> for running the robot in simulated mode without payload.	<i>Technical reference manual - System parameters</i>
System parameter <i>ModalPayload-Mode</i> for activating and deactivating payload.	<i>Technical reference manual - System parameters</i>
<i>Path Offset</i>	<i>Application manual - Controller software IRC5</i>

1 Instructions

1.235 SenDevice - connect to a sensor device

Sensor Interface

1.235 SenDevice - connect to a sensor device

Usage

SenDevice is used to connect to a sensor device connected to the sensor interface.

The sensor interface communicates with sensors via I/O devices.

Configuration example

This is an example of a sensor channel configuration.

These parameters belong to the type *Transmission Protocol* in the topic *Communication*.

Name	Type	Remote Address	Remote Port
sen1:	SOCKDEV	192.168.125.101	6344

Basic examples

The following example illustrates the instruction SenDevice:

Example 1

```
! Define variable numbers
CONST num SensorOn := 6;
CONST num XCoord := 8;
CONST num YCoord := 9;
CONST num ZCoord := 10;
VAR pos SensorPos;
! Connect to the sensor device" sen1:" (defined in sio.cfg).
SenDevice "sen1:";
! Request start of sensor measurements
WriteVar "sen1:", SensorOn, 1;
! Read a cartesian position from the sensor.
SensorPos.x := ReadVar "sen1:", XCoord;
SensorPos.y := ReadVar "sen1:", YCoord;
SensorPos.z := ReadVar "sen1:", ZCoord;
! Stop sensor
WriteVar "sen1:", SensorOn, 0;
```

Arguments

SenDevice device

device

Data type: string

The I/O device name configured in sio.cfg for the sensor used.

Syntax

```
ReadBlock
[device ':='] <expression(IN) of string>', '
[BlockNo ':='] <expression (IN) of num>', '
[FileName ':='] <expression (IN) of string>';'
```

Continues on next page

Related information

For information about	See
Write a sensor variable	WriteVar - Write variable on page 1112
Read a sensor variable	ReadVar - Read variable from a device on page 1440
Write a sensor data block	WriteBlock - Write block of data to device on page 1102
Configuration of sensor communication	<i>Technical reference manual - System parameters</i>

1 Instructions

1.236 Set - Sets a digital output signal
RobotWare Base

1.236 Set - Sets a digital output signal

Usage

Set is used to set the value of a digital output signal to one.

Basic examples

The following examples illustrate the instruction Set:

Example 1

```
Set do15;
```

The signal do15 is set to 1.

Example 2

```
Set weldon;
```

The signal weldon is set to 1.

Arguments

```
Set Signal
```

Signal

Data type: signaldo

The name of the signal to be set to one.

Program execution

There is a short delay before the signal physically gets its new value. If you do not want the program execution to continue until the signal has got its new value then you can use the instruction SetDO with the optional parameter \Sync.

The true value depends on the configuration of the signal. If the signal is inverted in the system parameters then this instruction causes the physical channel to be set to zero.

Error handling

The following recoverable errors are generated and can be handled in an error handler. The system variable ERRNO will be set to:

Name	Cause of error
ERR_NO_ALIASIO_DEF	The signal variable is a variable declared in RAPID. It has not been connected to an I/O signal defined in the I/O configuration with instruction AliasIO.
ERR_NORUNUNIT	There is no contact with the I/O device.
ERR_SIG_NOT_VALID	The I/O signal cannot be accessed. The reasons can be that the I/O device is not running or an error in the configuration (only valid for ICI field bus).

Syntax

```
Set  
[ Signal ':=' ] < variable (VAR) of signaldo > ';' 
```

Continues on next page

Related information

For information about	See
Setting a digital output signal to zero	Reset - Resets a digital output signal on page 609
Change the value of a digital output signal	SetDO - Changes the value of a digital output signal on page 704
Input/Output instructions	<i>Technical reference manual - RAPID Overview</i>
Input/Output functionality in general	<i>Technical reference manual - RAPID Overview</i>
Configuration of I/O	<i>Technical reference manual - System parameters</i>

1 Instructions

1.237 SetAllDataVal - Set a value to all data objects in a defined set
RobotWare Base

1.237 SetAllDataVal - Set a value to all data objects in a defined set

Usage

SetAllDataVal(*Set All Data Value*) makes it possible to set a new value to all data objects of a certain type that match the given grammar.

Basic examples

The following example illustrates the instruction SetAllDataVal:

```
VAR mydata mydata0:=0;
...
SetAllDataVal "mydata"\TypeMod:="mytypes"\Hidden,mydata0;
```

This will set all data objects of data type `mydata` in the system to the same value that the variable `mydata0` has (in the example to 0). The user defined data type `mydata` is defined in the module `mytypes`.

Arguments

```
SetAllDataVal Type [\TypeMod] [\Object] [\Hidden] Value
```

Type

Data type: string

The type name of the data objects to be set.

[\TypeMod]

Type Module

Data type: string

The module name where the data type is defined, if using user defined data types.

Argument `TypeMode` cannot be used for data in modules installed as `-Shared` or `-Installed`. The module name is not available for those data.

See *Technical reference manual - System parameters*, topic *Controller*, type *Automatic Loading of Modules*.

[\Object]

Data type: string

The default behavior is to set all data objects of the data type above but this option makes it possible to name one or several objects with a regular expression. See also the instruction `SetDataSearch`.

[\Hidden]

Data type: switch

This also matches data objects that are in routines (routine data or parameters) hidden by some routine in the call chain.

Value

Data type: anytype

This argument holds the new value to be set. The data type must be the same as the data type for the object to be set.

Continues on next page

Program execution

The instruction will fail if the specification for `Type` or `TypeMod` is wrong.

If the matching data object is an array then all elements of the array will be set to the specified value.

If the matching data object is read-only data then the value will not be changed.

If the system does not have any matching data objects then the instruction will accept it and return successfully.

Error handling

The following recoverable errors can be generated. The errors can be handled in an ERROR handler. The system variable `ERRNO` will be set to:

Name	Cause of error
<code>ERR_SYMBOL_TYPE</code>	The data object and the variable used in argument <code>Value</code> is of different types. If using <code>ALIAS</code> datatypes, you will also get this ERROR, even though the types might have the same base data type.

Limitations

For a semivalue data type it is not possible to search for the associated value data type. For example, if searching for `dionum` then there are no search results for signal `signaldi` and if searching for `num` then there are no search results for signals `signalgi` or `signalai`.

It is not possible to set a value to a variable declared as `LOCAL` in a built-in RAPID module.

Syntax

```
SetAllDataVal
  [Type :=] <expression (IN) of string>
  ['\TypeMod :='<expression (IN) of string>]
  ['\Object :='<expression (IN) of string>]
  ['\Hidden ] ', '
  [Value :=] <variable (VAR) of anytype>;'
```

Related information

For information about	See
Define a symbol set in a search session	SetDataSearch - Define the symbol set in a search sequence on page 696
Get next matching symbol	GetNextSym - Get next matching symbol on page 1299
Get the value of a data object	GetDataVal - Get the value of a data object on page 229
Set the value of a data object	SetDataVal - Set the value of a data object on page 701
The related data type <code>datapos</code>	datapos - Enclosing block for a data object on page 1646
<i>Advanced RAPID</i>	<i>Application manual - Controller software IRC5</i>

1 Instructions

1.238 SetAO - Changes the value of an analog output signal *RobotWare Base*

1.238 SetAO - Changes the value of an analog output signal

Usage

SetAO is used to change the value of an analog output signal.

Basic examples

The following example illustrates the instruction SetAO:

See also [More examples on page 695](#).

Example 1

```
SetAO ao2, 5.5;
```

The signal ao2 is set to 5.5.

Arguments

SetAO Signal Value

Signal

Data type: signalao

The name of the analog output signal to be changed.

Value

Data type: num

The desired value of the signal.

Program execution

The programmed value is scaled (in accordance with the system parameters) before it is sent on the physical channel. A diagram of how analog signal values are scaled is shown in the figure below.

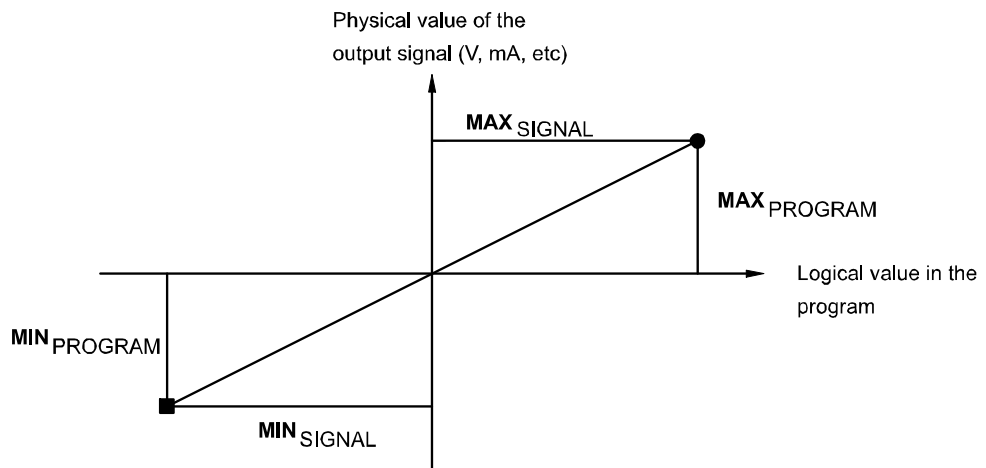

xx0500002408

Continues on next page

Error handling

The following recoverable errors are generated and can be handled in an error handler. The system variable `ERRNO` will be set to:

Name	Cause of error
<code>ERR_AO_LIM</code>	The programmed <code>Value</code> argument for the specified analog output signal <code>Signal</code> is outside limits.
<code>ERR_NO_ALIASIO_DEF</code>	The signal variable is a variable declared in RAPID. It has not been connected to an I/O signal defined in the I/O configuration with instruction <code>AliasIO</code> .
<code>ERR_NORUNUNIT</code>	There is no contact with the I/O device.
<code>ERR_SIG_NOT_VALID</code>	The I/O signal cannot be accessed. The reasons can be that the I/O device is not running or an error in the configuration (only valid for ICI field bus).

More examples

More examples of the instruction `SetAO` are illustrated below.

Example 1

```
SetAO weldcurr, curr_outp;
```

The signal `weldcurr` is set to the same value as the current value of the variable `curr_outp`.

Syntax

```
SetAO
  [ Signal ':= ' ] < variable (VAR) of signalao > ','
  [ Value ':= ' ] < expression (IN) of num > ';'

```

Related information

For information about	See
Input/Output instructions	<i>Technical reference manual - RAPID Overview</i>
Input/Output functionality in general	<i>Technical reference manual - RAPID Overview</i>
Configuration of I/O	<i>Technical reference manual - System parameters</i>

1 Instructions

1.239 SetDataSearch - Define the symbol set in a search sequence

RobotWare Base

1.239 SetDataSearch - Define the symbol set in a search sequence

Usage

`SetDataSearch` is used together with function `GetNextSym` to retrieve data objects from the system.

Basic examples

The following examples illustrate the instruction `SetDataSearch`:

Example 1

```
VAR datapos block;  
VAR string name;  
...  
SetDataSearch "robtarget"\InTask;  
WHILE GetNextSym(name,block \Recursive) DO  
...  

```

This session will find all objects for a `robtarget` in the task.

Example 2

```
RECORD testrecord  
  num value1;  
  num value2;  
ENDRECORD  
  
VAR datapos block;  
VAR string name;  
VAR testrecord mydata1:= [1,2];  
VAR testrecord mydata2:= [3,4];  
...  
SetDataSearch "testrecord" \TypeMod:="MYMODULE" \InTask;  
WHILE GetNextSym(name,block \Recursive) DO  
...  

```

The data type `testrecord` is a user defined data type, and defined in the module named `MYMODULE`. This session will find all objects for a `testrecord` in the task.

Arguments

```
SetDataSearch Type [\TypeMod] [\Object] [\PersSym]  
              [\VarSym][\ConstSym] [\InTask] | [\InMod]  
              [\InRout][\GlobalSym] | [\LocalSym]
```

Type

Data type: string

The data type name of the data objects to be retrieved.

[\TypeMod]]

Type Module

Data type: string

The module name where the data type is defined, if using user defined data types.

Continues on next page

1.239 SetDataSearch - Define the symbol set in a search sequence

RobotWare Base

Continued

Argument `TypeMode` cannot be used for data in modules installed as `-Shared` or `-Installed`. The module name is not available for those data.

See *Technical reference manual - System parameters*, topic *Controller*, type *Automatic Loading of Modules*.

[\Object]

Data type: `string`

The default behavior is to set all data objects of the data type above but this option makes it possible to name one or several objects with a regular expression.

A regular expression is a powerful mechanism to specify a grammar to match the data object names. The string can consist of either ordinary characters and meta characters. A meta character is a special operator used to represent one or more ordinary characters in the string with the purpose to extend the search. It is possible to see if a string matches a specified pattern as a whole or search within a string for a substring matching a specified pattern.

Within a regular expression all alphanumeric characters match themselves. That is to say that the pattern "abc" will only match a data object named "abc". To match all data object names containing the character sequence "abc" it is necessary to add some meta characters. The regular expression for this is `.*abc.*`.

The available meta character set is shown below.

Expression	Meaning
.	Any single character.
[s]	Any single character in the non-empty set s, where s is a sequence of characters. Ranges may be specified as c-c.
[^s]	Any single character not in the set s.
r*	Zero or more occurrences of the regular expression r.
r+	One or more occurrences of the regular expression r.
r?	Zero or one occurrence of the regular expression r.
(r)	The regular expression r. Used for separate that regular expression from another.
r r'	The regular expressions r or r'.
.*	Any character sequence (zero, one, or several characters).

The default behavior is to accept any symbols but if one or several of following `PersSym`, `VarSym`, or `ConstSym` is specified then only symbols that match the specification are accepted.

[\PersSym]

Persistent Symbols

Data type: `switch`

Accept persistent variable (`PERS`) symbols.

[\VarSym]

Variable Symbols

Data type: `switch`

Continues on next page

1 Instructions

1.239 SetDataSearch - Define the symbol set in a search sequence

RobotWare Base

Continued

Accept variable (VAR) symbols.

[\ConstSym]

Constant Symbols

Data type: `switch`

Accept constant (CONST) symbols.

If not one of the flags `\InTask` or `\InMod` are specified then the search is started at system level. The system level is the root to all other symbol definitions in the symbol tree. At the system level all build- in symbols are located plus the handle to the task level. At the task level all loaded global symbols are located plus the handle to the modules level.

If the `\Recursive` flag is set in `GetNextSym` then the search session will enter all loaded modules and routines below the system level.

[\InTask]

In Task

Data type: `switch`

Start the search at the task level. At the task level all loaded global symbols are located plus the handle to the modules level.

If the `\Recursive` flag is set in `GetNextSym` then the search session will enter all loaded modules and routines below the task level.

[\InMod]

In Module

Data type: `string`

Start the search at the specified module level. At the module level all loaded global and local symbols declared in the specified module are located plus the handle to the routines level.

If the `\Recursive` flag is set in `GetNextSym` then the search session will enter all loaded routines below the specified module level (declared in the specified module).

[\InRout]

In Routine

Data type: `string`

Search only at the specified routine level.

The module name for the routine must be specified in the argument `\InMod`.

The default behavior is to match both local and global module symbols, but if one of following `\GlobalSym` or `\LocalSym` is specified then only symbols that match the specification are accepted.

[\GlobalSym]

Global Symbols

Data type: `switch`

Skip local module symbols.

Continues on next page

[\LocalSym]

Local Symbols

Data type: switch

Skip global module symbols.

Program execution

The instruction will fail if the specification for one of Type, TypeMod, InMod, or InRout is wrong.

If the system does not have any matching objects the instruction will accept it and return successfully but the first GetNextSym will return FALSE.

Limitations

Array data objects cannot be defined in the symbol search set and cannot be found in a search sequence.

For a semivalue data type it is not possible to search for the associated value data type. For example, if searching for dionum then there are no search results for signal signaldi and if searching for num then there are no search results for signals signalgi or signalai.

Installed built-in symbols declared as LOCAL will never be found, irrespective of use of argument \GlobalSym, \LocalSym or none of these.

Installed built-in symbols declared as global or as TASK will always be found, irrespective of use of argument \GlobalSym, \LocalSym or none of these.

It is not possible to use SetDataSearch for searching for data of some ALIAS data type defined with RAPID code. No limitation for predefined ALIAS data type.

Syntax

```
SetDataSearch
  [Type ':=' ] <expression (IN) of string>
  [ '\TypeMod ':=' <expression (IN) of string> ]
  [ '\Object ':=' <expression (IN) of string> ]
  [ '\PersSym ]
  [ '\VarSym ]
  [ '\ConstSym ]
  [ '\InTask ]
  [ [ '\InMod' :=' <expression (IN) of string> ]
  [ '\InRout :=' <expression (IN) of string> ]
  [ '\GlobalSym ]
  [ [ '\LocalSym' ; ]
```

Related information

For information about	See
Get next matching symbol	GetNextSym - Get next matching symbol on page 1299
Get the value of a data object	GetDataVal - Get the value of a data object on page 229
Set the value of many data objects	SetAllDataVal - Set a value to all data objects in a defined set on page 692

Continues on next page

1 Instructions

1.239 SetDataSearch - Define the symbol set in a search sequence

RobotWare Base

Continued

For information about	See
The related data type <code>datapos</code>	datapos - Enclosing block for a data object on page 1646
<i>Advanced RAPID</i>	<i>Application manual - Controller software IRC5</i>

1.240 SetDataVal - Set the value of a data object

Usage

SetDataVal (*Set Data Value*) makes it possible to set a value for a data object that is specified with a string variable.

Basic examples

The following examples illustrate the instruction SetDataVal:

Example 1

```
VAR datapos block;
VAR bool truevar:=TRUE;
...
SetDataSearch "bool" \Object:="my.*" \InMod:="mymod"\LocalSym;
WHILE GetNextSym(name,block) DO
  SetDataVal name\Block:=block,truevar;
ENDWHILE
```

This session will set all local bool that begin with my in the module mymod to TRUE.

Example 2

```
VAR string StringArrVar_copy{2};
...
StringArrVar_copy{1} := "test1";
StringArrVar_copy{2} := "test2";
SetDataVal "StringArrVar", StringArrVar_copy;
```

This session will set the array StringArrVar to contain the two strings test1 and test2.

Arguments

```
SetDataVal Object [\Block][\TaskRef][\TaskName] Value
```

Object

Data type: string

The name of the data object.

[\Block]

Data type: datapos

The enclosed block to the data object. This can only be fetched with the GetNextSym function.

If this argument is omitted then the value of the visible data object in the current program execution scope will be set.

[\TaskRef]

Task Reference

Data type: taskid

The program task identity in which to search for the data object specified. When using this argument, you may search for PERS or TASKPERS declarations in other tasks, any other declarations will result in an error.

Continues on next page

1 Instructions

1.240 SetDataVal - Set the value of a data object

RobotWare Base

Continued

For all program tasks in the system the predefined variables of the data type `taskid` will be available. The variable identity will be "taskname"+"Id", e.g. for the `T_ROB1` task the variable identity will be `T_ROB1Id`.

[\TaskName]

Data type: `string`

The program task name in which to search for the data object specified. When using this argument, you may search for `PERS` or `TASKPERS` declarations in other tasks, any other declarations will result in an error.

Value

Data type: `anytype`

Variable which holds the new value to be set. The data type must be the same as the data type for the data object to be set. The set value must be fetched from a variable but can be stored in a variable or persistent.

Error handling

The following recoverable errors are generated and can be handled in an error handler. The system variable `ERRNO` will be set to:

Name	Cause of error
<code>ERR_SYM_ACCESS</code>	<ul style="list-style-type: none">• The data object is non-existent.• The data object is read-only data.• The data object is routine data or routine parameter and not located in the current active routine.• Searching in other tasks for other declarations than <code>PERS</code> or <code>TASKPERS</code>.ⁱ
<code>ERR_INVDIM</code>	The data object and the variable used in argument <code>Value</code> have different dimensions
<code>ERR_SYMBOL_TYPE</code>	The data object and the variable used in argument <code>Value</code> is of different types. If using <code>ALIAS</code> datatypes, you will also get this ERROR, even though the types might have the same base data type.
<code>ERR_TASKNAME</code>	The program task name in argument <code>\TaskName</code> cannot be found in the system.

ⁱ When using the arguments `TaskRef` or `TaskName` you may search for `PERS` or `TASKPERS` declarations in other tasks, any other declarations will result in an error. Searching for a `PERS` declared as `LOCAL` in other tasks will also result in an error.

Limitations

For a semivalue data type it is not possible to search for the associated value data type. E.g. if searching for `dionum` then no search hit for signal `signaldi` will be obtained and if searching for `num` then no search hit for signals `signalgi` or `signalai` will be obtained.

It is not possible to set a value to a variable declared as `LOCAL` in a built-in RAPID module.

Syntax

```
SetDataVal  
[ Object ':= ' ] < expression (IN) of string >
```

Continues on next page

```
[ '\Block' := <variable (VAR) of datapos> ]
|[ '\TaskRef' := <variable (VAR) of taskid> ]
|[ '\TaskName' := <expression (IN) of string> ] ', ' ]
[ Value := ] <variable (VAR) of anytype> ]';'
```

Related information

For information about	See
Define a symbol set in a search session	SetDataSearch - Define the symbol set in a search sequence on page 696
Get next matching symbol	GetNextSym - Get next matching symbol on page 1299
Get the value of a data object	GetDataVal - Get the value of a data object on page 229
Set the value of many data objects	SetAllDataVal - Set a value to all data objects in a defined set on page 692
The related data type <code>datapos</code>	datapos - Enclosing block for a data object on page 1646
<i>Advanced RAPID</i>	<i>Application manual - Controller software IRC5</i>

1 Instructions

1.241 SetDO - Changes the value of a digital output signal

RobotWare Base

1.241 SetDO - Changes the value of a digital output signal

Usage

SetDO is used to change the value of a digital output signal, with or without a time delay or synchronization.

Basic examples

The following examples illustrate the instruction SetDO.

Example 1

```
SetDO do15, 1;
```

The signal do15 is set to 1.

Example 2

```
SetDO weld, off;
```

The signal weld is set to off

.

Example 3

```
SetDO \SDelay := 0.2, weld, high;
```

The signal weld is set to high with a delay of 0.2 s. The program execution continues with the next instruction.

Example 4

```
SetDO \Sync ,do1, 0;
```

The signal do1 is set to 0. Program execution waits until the signal is physically set to the specified value.

Arguments

```
SetDO [ \SDelay ]|[ \Sync ] Signal Value
```

[\SDelay]

Signal Delay

Data type: num

Delays the change for the amount of time given in seconds (max. 2000s). Program execution continues directly with the next instruction. After the given time delay the signal is changed without the rest of the program execution being affected.

[\Sync]

Synchronization

Data type: switch

If this argument is used then the program execution will wait until the signal is physically set to the specified value.

Signal

Data type: signaldo

The name of the signal to be changed.

Continues on next page

Value

Data type: dionum

The desired value of the signal 0 or 1.

Specified Value	Set digital output to
0	0
Any value except 0	1

Program execution

The true value depends on the configuration of the signal. If the signal is inverted in the system parameters then the value of the physical channel is the opposite.

If neither of the arguments `\SDelay` or `\Sync` are used then the signal will be set as fast as possible, and the next instruction will be executed at once without waiting for the signal to be physically set.

Error handling

The following recoverable errors are generated and can be handled in an error handler. The system variable `ERRNO` will be set to:

Name	Cause of error
<code>ERR_ARGVALERR</code>	The value for the <code>SDelay</code> argument exceeds the maximum value allowed (2000 s).
<code>ERR_NO_ALIASIO_DEF</code>	The signal variable is a variable declared in RAPID. It has not been connected to an I/O signal defined in the I/O configuration with instruction <code>AliasIO</code> .
<code>ERR_NORUNUNIT</code>	There is no contact with the I/O device.
<code>ERR_SIG_NOT_VALID</code>	The I/O signal cannot be accessed. The reasons can be that the I/O device is not running or an error in the configuration (only valid for ICI field bus).

Limitations

If a `SetDO` with a `\SDelay` argument is followed by a new `SetDO` on the same signal, with or without `\SDelay` argument, then the first `SetDO` will be cancelled if the second `SetDO` is executed before the delay time of the first `SetDO` have expired.

Syntax

```
SetDO
  ['\ SDelay ::= ' <expression (IN) of num>', ' ]
  ['\ Sync', ' ]
  [Signal ::= ' <variable (VAR) of signaldo>', ' ]
  [Value ::= ' <expression (IN) of dionum>', ' ]
```

Related information

For information about	See
Input/Output instructions	<i>Technical reference manual - RAPID Overview</i>
Input/Output functionality in general	<i>Technical reference manual - RAPID Overview</i>

Continues on next page

1 Instructions

1.241 SetDO - Changes the value of a digital output signal

RobotWare Base

Continued

For information about	See
Configuration of I/O	<i>Technical reference manual - System parameters</i>

1.242 SetGO - Changes the value of a group of digital output signals

Usage

SetGO is used to change the value of a group of digital output signals with or without a time delay.

Basic examples

The following examples illustrate the instruction SetGO:

Example 1

```
SetGO go2, 12;
```

The signal go2 is set to 12. If go2 comprises 4 signals, e.g. outputs 6-9, then outputs 6 and 7 are set to zero while outputs 8 and 9 are set to one.

Example 2

```
SetGO \SDelay := 0.4, go2, 10;
```

The signal go2 is set to 10. If go2 comprises 4 signals, e.g. outputs 6-9, then outputs 6 and 8 are set to zero while outputs 7 and 9 are set to one with a delay of 0.4 s. The program execution continues with the next instruction.

Example 3

```
SetGO go32, 4294967295;
```

The signal go32 is set to 4294967295. go32 comprises 32 signals, which are all set to one.

Arguments

```
SetGO [ \SDelay ] Signal Value | Dvalue
```

[\SDelay]

Signal Delay

Data type: num

Delays the change for the period of time stated in seconds (max. 2000s). Program execution continues directly with the next instruction. After the specified time delay the value of the signals is changed without the rest of the program execution being affected.

If the argument is omitted then the signal values are changed directly.

Signal

Data type: signalgo

The name of the signal group to be changed.

Value

Data type: num

The desired value of the signal group (a positive integer) is shown in the table below.

The permitted value is dependent on the number of signals in the group. A num datatype can hold the value for a group of 23 signals or less.

Continues on next page

1 Instructions

1.242 SetGO - Changes the value of a group of digital output signals

RobotWare Base

Continued

Dvalue

Data type: dnum

The desired value of the signal group (a positive integer) is shown in the table below.

The permitted value is dependent on the number of signals in the group. A dnum datatype can hold the value for a group of 32 signals or less.

No. of signals	Permitted Value	Permitted Dvalue
1	0-1	0-1
2	0-3	0-3
3	0-7	0-7
4	0-15	0-15
5	0-31	0-31
6	0-63	0-63
7	0-127	0-127
8	0-255	0-255
9	0-511	0-511
10	0-1023	0-1023
11	0-2047	0-2047
12	0-4095	0-4095
13	0-8191	0-8191
14	0-16383	0-16383
15	0-32767	0-32767
16	0-65535	0-65535
17	0-131071	0-131071
18	0-262143	0-262143
19	0-524287	0-524287
20	0-1048575	0-1048575
21	0-2097151	0-2097151
22	0-4194303	0-4194303
23	0-8388607	0-8388607
24	*	0-16777215
25	*	0-33554431
26	*	0-67108863
27	*	0-134217727
28	*	0-268435455
29	*	0-536870911
30	*	0-1073741823
31	*	0-2147483647
32	*	0-4294967295

Continues on next page

1.242 SetGO - Changes the value of a group of digital output signals

RobotWare Base

Continued

*) The `Value` argument of type `num` can only hold up to 23 signals compared to the `Dvalue` argument of type `dnum` that can hold up to 32 signals.

Program execution

The programmed value is converted to an unsigned binary number. This binary number is sent on the signal group with the result that individual signals in the group are set to 0 or 1. Because of internal delays the value of the signal may be undefined for a short period of time.

Error handling

The following recoverable errors are generated and can be handled in an error handler. The system variable `ERRNO` will be set to:

Name	Cause of error
<code>ERR_ARGVALERR</code>	The value for the <code>SDelay</code> argument exceeds the maximum value allowed (2000 s).
<code>ERR_GO_LIM</code>	The programmed <code>Value</code> or <code>Dvalue</code> argument for the specified digital group output signal <code>Signal</code> is outside limits.
<code>ERR_NO_ALIASIO_DEF</code>	The signal variable is a variable declared in RAPID. It has not been connected to an I/O signal defined in the I/O configuration with instruction <code>AliasIO</code> .
<code>ERR_NORUNUNIT</code>	There is no contact with the I/O device.
<code>ERR_SIG_NOT_VALID</code>	The I/O signal cannot be accessed. The reasons can be that the I/O device is not running or an error in the configuration (only valid for ICI field bus).

Limitations

Maximum number of signals that can be used for a group is 23 if argument `Value` is used and 32 if argument `Dvalue` is used. This limitation is valid for all instructions and functions using group signals.

Syntax

```
SetGO
  [ '\ ' SDelay ' := ' < expression (IN) of num > ', ' ]
  [ Signal ' := ' ] < variable (VAR) of signalgo > ', '
  [ Value ' := ' ] < expression (IN) of num >
  | [ Dvalue ' := ' ] < expression (IN) of dnum > ';'

```

Related information

For information about	See
Other input/output instructions	<i>Technical reference manual - RAPID Overview</i>
Input/Output functionality in general	<i>Technical reference manual - RAPID Overview</i>
Configuration of I/O (system parameters)	<i>Technical reference manual - System parameters</i>

1 Instructions

1.243 SetLeadThrough - Activate and deactivate lead-through *LeadThrough*

1.243 SetLeadThrough - Activate and deactivate lead-through

Usage

`SetLeadThrough` is used to activate and deactivate lead-through for a TCP robot.

Basic examples

The following examples illustrates the instruction `SetLeadThrough`.

Example 1

```
SetLeadThrough \On;
```

Activates lead-through for the TCP robot `ROB_L` if executed in the `T_ROB_L` RAPID task. By default a `StopMove` instruction is ordered when lead-through is activated.

Example 2

```
SetLeadThrough \Off;
```

Deactivates lead-through for the TCP robot `ROB_L` if executed in the `T_ROB_L` RAPID task. By default a `ClearPath` instruction and a `StartMove` instruction is also executed.

Example 3

```
SetLeadThrough \On \NoStopMove;  
..  
StopMove;  
..  
SetLeadThrough \Off \NoStartMove \NoClearPath;  
..  
StartMove;
```

Set lead-through for the TCP robot. The lead-through will not be activated until a `StopMove` instruction has been executed or the program execution has been stopped. The deactivation of the lead-through is done and later on the movement is restarted.

Arguments

```
SetLeadThrough [\On] | [\Off] [\NoStopMove] | [\NoStartMove]  
[\NoClearPath]
```

[`\On`]

Data type: switch
Activate lead-through.

[`\Off`]

Data type: switch
Deactivate lead-through.

[`\NoStopMove`]

Data type: switch
Can only be used together with the `\On` switch.

Continues on next page

1.243 SetLeadThrough - Activate and deactivate lead-through *LeadThrough* *Continued*

If using `\NoStopMove` switch, no `StopMove` order will be executed. Lead-through has been set, but not activated. Lead-through is activated when the program execution is stopped or when a `StopMove` instruction is executed.

[`\NoStartMove`]

Data type: `switch`

Can only be used together with the `\Off` switch.

If this switch is used, the restart of the movement of the TCP robot will not be ordered. A `StartMove` instruction is needed to resume the movement.

[`\NoClearPath`]

Data type: `switch`

Can only be used together with the `\Off` switch.

The path is not cleared when deactivating lead-through, and the TCP robot will continue on the programmed path when the `StartMove` order is executed.

Program execution

Lead-through status is set if the argument `\On` (or no argument) is used, but not activated until a `StopMove` instruction has been executed or the program execution is stopped.

By default a `StopMove` instruction is executed when lead-through is activated with `SetLeadThrough \On`. A `ClearPath` instruction and a `StartMove` instruction is executed when lead-through is deactivated if not using `\NoClearPath` or `\NoStartMove` switches.

If the `SetLeadThrough` instruction is executed from a non-motion task, the lead-through activation will be done for the TCP robot in the connected motion task. The `StartMove` order must be done from the same task as the `StopMove` order.

The activation of lead-through is valid until a `SetLeadThrough \Off` instruction is executed.

The default value (no lead-through) is automatically set:

- when using the restart mode **Reset RAPID**.
- when loading a new program or a new module.
- when starting program execution from the beginning.
- when moving the program pointer to main.
- when moving the program pointer to a routine.
- when moving the program pointer in such a way that the execution order is lost.
- when going to motors off.

Continues on next page

1 Instructions

1.243 SetLeadThrough - Activate and deactivate lead-through

LeadThrough

Continued

Error handling

The following recoverable errors are generated and can be handled in an error handler. The system variable `ERRNO` will be set to:

Name	Cause of error
<code>ERR_PATHDIST</code>	The robot is too far from the path (more than 10 mm or 20 degrees) to perform a restart of the interrupted movement. Move the robot closer to the path before attempting <code>RETRY</code> .
<code>ERR_STARTMOVE</code>	The robot is in hold state when executing a <code>SetLeadThrough \Off</code> . Wait some time before attempting <code>RETRY</code> .
<code>ERR_PROGSTOP</code>	The robot is in program stop state when executing a <code>SetLeadThrough \Off</code> . Wait some time before attempting <code>RETRY</code> .
<code>ERR_ALRDY_MOVING</code>	The robot is already moving when executing a <code>SetLeadThrough \Off</code> . Wait some time before attempting <code>RETRY</code> .

Limitations

- Only one of several non-motion tasks is allowed at the same time to do `SetLeadThrough` against the same motion task.
- `SetLeadThrough` only works for TCP robots.

The instruction `SetLeadThrough` can only be used for YuMi robots.

Syntax

```
SetLeadThrough  
  ['\On] | ['\Off]  
  ['\NoStopMove] | ['\NoStartMove]  
  ['\NoClearPath] ';' ;
```

Related information

For information about	See
Check lead-through status	IsLeadThrough - Check lead-through status on page 1347
Stopping movements	StopMove - Stops robot movement on page 820
Continuing a movement	StartMove - Restarts robot movement on page 791
Continuing a movement	StartMoveRetry - Restarts robot movement and execution on page 794
More examples	ClearPath - Clear current path on page 141

1.244 SetSysData - Set system data

Usage

`SetSysData` activates the specified system data name for the specified data type. With this instruction it is possible to change the current active Tool, Work Object, Payload or Total Load for the robot in actual or connected motion task.

Basic examples

The following example illustrates the instruction `SetSysData`:

Example 1

```
SetSysData tool5;
```

The tool `tool5` is activated.

```
SetSysData tool0 \ObjectName := "tool6";
```

The tool `tool6` is activated.

```
SetSysData anytool \ObjectName := "tool2";
```

The tool `tool2` is activated.

Arguments

```
SetSysData SourceObject [\ObjectName]
```

SourceObject

Data type: anytype

Persistent variable that should be active as current system data.

The data type of this argument also specifies the type of system data to be activated for the robot in actual or connected motion task.

Data type	Type of system data
tooldata	Tool
wobjdata	Work Object
loaddata	Payload/Total Load

Entire array or record component cannot be used.

[\ObjectName]

Data type: string

If this optional argument is specified then it specifies the name of the data object to be active (overrides name specified in argument `SourceObject`). The data type of the data object to be active is always fetched from the argument `SourceObject`.

Program execution

The current active system data object for the Tool, Work Object, Payload or Total Load is set according to the arguments.

Note that this instruction only activates a new data object (or the same as before) and never changes the value of any data object.

Continues on next page

1 Instructions

1.244 SetSysData - Set system data

RobotWare Base

Continued

Syntax

```
SetSysData
  [ SourceObject':=' ] < persistent(PERS) of anytype>
  [ '\ObjectName':=' < expression (IN) of string> ] ';' ;'
```

Related information

For information about	See
Definition of tools	tooldata - Tool data on page 1776
Definition of work objects	wobjdata - Work object data on page 1803
Definition of payload	loaddata - Load data on page 1682
Get system data	GetSysData - Get system data on page 236
Example of how to use TLoad, Total Load.	MoveL - Moves the robot linearly on page 458
System parameter <i>ModalPayloadMode</i> for activating and deactivating payload. (Topic Controller, Type General RAPID, Action values, <i>ModalPayloadMode</i>)	<i>Technical reference manual - System parameters</i>
<i>Advanced RAPID</i>	<i>Application manual - Controller software IRC5</i>

1.245 SetupCyclicBool - Setup a Cyclic bool condition

Usage

SetupCyclicBool is used to set up a logical condition that cyclically will be evaluated and assigned to a persistent boolean variable, a *Cyclic bool*.

Basic examples

The following example illustrates the instruction SetupCyclicBool.

See also [More examples on page 716](#).

Example 1

```
PERS bool cyclicflag1;

PROC main()
  SetupCyclicBool cyclicflag1, di1=1 AND do2=1;
  ...
```

Sets up a cyclic evaluation of the logical condition `di1=1 AND do2=1` and assigns the result to the persistent boolean variable `cyclicflag1`.

Arguments

```
SetupCyclicBool Flag Cond [\Signal]
```

Flag

Data type: bool

The persistent boolean variable that stores the value of the logical condition.

Cond

Data type: bool

The logical expression that should be evaluated cyclically.

The expression can consist of:

- Constants or persistent variables of the types `bool`, `num` and `dnum` (and alias of `bool`, `num` and `dnum`).
- Global digital input and output signals.
- Operands: 'NOT' 'AND' 'OR' 'XOR' '=' '(' ')''

[\Signal]

Data type: signaldo

The result of the logical condition is written to the digital output signal used in the optional argument `Signal` when the expression is updated. It is not recommended to use the resultant signal as a part of the condition for a cyclic bool.



Note

Do not change the signal value from RAPID, for example, with `SetDO`. Then it can have another value than the expression that it should reflect.

Continues on next page

1 Instructions

1.245 SetupCyclicBool - Setup a Cyclic bool condition

RobotWare Base

Continued

Program execution

With this instruction it is possible to setup more complex conditions and use the cyclic flag instead to see if the condition is met or not.

The cyclic evaluation of the logical condition and the assignment to the persistent boolean variable is done every 12 ms.

The behavior of the Cyclic bool functionality can be configured. For more information see *Application manual - Controller software IRC5* and *Technical reference manual - System parameters*.

Error handling

The following recoverable errors are generated and can be handled in an error handler. The system variable `ERRNO` will be set to:

Name	Cause of error
ERR_NO_ALIASIO_DEF	The signal variable is a variable declared in RAPID. It has not been connected to an I/O signal defined in the I/O configuration with the instruction <code>AliasIO</code> .
ERR_NORUNUNIT	There is no contact with the I/O device.
ERR_SIG_NOT_VALID	The I/O signal cannot be accessed (only valid for ICI field bus).

More examples

More examples of the instruction `SetupCyclicBool` are illustrated below.

Example 1

```
ALIAS bool aliasBool;
PERS bool cyclicflag1;
TASK PERS aliasBool cyclicflag2:=FALSE;
PERS aliasBool flag1:=FALSE;
TASK PERS aliasBool flag2:=FALSE;
CONST num HIGH:=1;
CONST num LOW:=0;

PROC main()
  SetupCyclicBool cyclicflag1, (di1=HIGH AND di2=HIGH AND di3=LOW)
    OR flag1=TRUE;
  SetupCyclicBool cyclicflag2, di4=HIGH AND flag2=TRUE;
  ...
  WaitUntil cyclicflag1=TRUE;
  IF cyclicflag2 = TRUE THEN
    MoveL p1, v1000, z30, tool2;
  ELSE
    MoveL p2, v1000, z30, tool2;
  ENDIF
  ...
```

The example above sets up cyclic evaluation of 2 expressions. The execution waits until `cyclicflag1` is set. `cyclicflag2` decides to which position the robot should move.

Continues on next page

Example 2

```
!This condition is wrong:
SetupCyclicBool m1, 5;

!This condition is correct:
SetupCyclicBool m1, myNum = 5;
```

The first condition is not correct since the value 5 is not a boolean. The second condition is correct since the comparison can be evaluated as a boolean condition, i.e. TRUE or FALSE.

Limitations

- The expression must be evaluated to a boolean value TRUE or FALSE. All parts of the expression must also be evaluated to a boolean value TRUE or FALSE.
- Any PERS num or dnum, CONST num or dnum or literal num or dnum used in a condition must be of integer type. If using any decimal value this will cause a fatal error.

Syntax

```
SetupCyclicBool
  [Flag ':='] <persistent (PERS) of bool>', '
  [Cond ':='] <expression (IN) of bool>
  ['\' Signal ':=' <variable (VAR) of signaldo>'];'
```

Related information

For information about	See
Check if a persistent variable is a Cyclic bool	IsCyclicBool - Checks if a persistent variable is a Cyclic bool on page 1340
Remove a Cyclic bool condition	RemoveCyclicBool - Remove a Cyclic bool condition on page 600
Remove all Cyclic bool conditions	RemoveAllCyclicBool - Remove all Cyclic bool conditions on page 598
Cyclically evaluated logical conditions, Cyclic bool	Application manual - Controller software IRC5
Configuring Cyclic bool	Technical reference manual - System parameters

1 Instructions

1.246 SetupSuperv - Setup conditions for signal supervision in CAP *Continuous Application Platform (CAP)*

1.246 SetupSuperv - Setup conditions for signal supervision in CAP

Usage

SetupSuperv is used to set up conditions for I/O signals to be supervised. The conditions are collected in different lists:

- PRE
- PRE_START
- END_PRE
- START
- MAIN
- END_MAIN
- START_POST1
- POST1
- END_POST1
- START_POST2
- POST2
- END_POST2

For more information about supervision lists see *Application manual - Continuous Application Platform*.

As an optional parameter an out signal can be specified. This out signal is set to high, if the given condition fails.

Basic example

```
PROC main()  
  InitSuperv;  
  SetupSuperv diWR_EST, ACT, SUPERV_MAIN \ErrIndSig:= do_WR_Sup;  
  SetupSuperv diGA_EST, ACT, SUPERV_MAIN;  
  CapL p2, v100, cdata1, weavestart, weave, fine, tWeldGun;  
ENDPROC
```

SetupSuperv is used to set up supervision on signals. If signal *diWR_EST* fails during *SUPERV_MAIN* phase, the digital output signal *do_WR_Sup* is set high.

The SetupSuperv instruction should be executed only if supervision data is changed. If the supervision data is never changed, it is a good idea to put it into a module, that is executed from the startup shelf.

Arguments

```
SetupSuperv Signal Condition Listtype [\ErrIndSig]
```

Signal

Data type: signaldi

Digital signal to be supervised.

Continues on next page

1.246 SetupSuperv - Setup conditions for signal supervision in CAP Continuous Application Platform (CAP)

Continued

Condition

Data type: num

The name representing one of the following available conditions:

ACT:	Used for status supervision. Expected signal status during supervision: active. If the signal becomes passive, supervision triggers.
PAS:	Used for status supervision. Expected signal status during supervision: passive. If the signal becomes active, supervision triggers.
POS_EDGE:	Used for handshake supervision. Expected signal status at the end of supervision: active. If the signal does not become active within the chosen timeout, supervision triggers.
NEG_EDGE:	Used for handshake supervision. Expected signal status at the end of supervision: passive. If the signal does not become passive within the chosen timeout, supervision triggers.

Listtype

Data type: num

The name representing the number of the different lists (for example, phases in the process):

- SUPERV_PRE
- SUPERV_PRE_START
- SUPERV_END_PRE
- SUPERV_START
- SUPERV_MAIN
- SUPERV_END_MAIN
- SUPERV_START_POST1
- SUPERV_POST1
- SUPERV_END_POST1
- SUPERV_START_POST2
- SUPERV_POST2
- SUPERV_END_POST2

[ErrIndSig]

Data type: signaldo

Used to indicate which condition that failed if a failure has occurred. When the failure occurs the value on this signal is set to 1. This is an optional parameter.

Program execution

The given signal and its condition is added to the selected list. If a signal fails, the CapL/CapC instruction will report that a supervision error occurred during the specified phase and which signal(s) failed.

Errors

CAP_SPV_LIM

The maximum number of supervisions set up is exceeded.

Continues on next page

1 Instructions

1.246 SetupSuperv - Setup conditions for signal supervision in CAP

Continuous Application Platform (CAP)

Continued

CAP_SPV_UNK_LST

The supervision list is unknown.

Limitations

Only digital input signals can be supervised.

Status supervision applies for a complete sequence of CAP instructions (see section *Supervision and process phases* in *Application manual - Continuous Application Platform*).

Syntax

```
SetupSuperv  
  [Signal ':='] < variable (VAR) of signaldi > ','  
  [Condition ':='] < variable (IN) of num > ','  
  [Listtype ':='] < variable (IN) of num >  
  [\ErrIndSig ':='] < variable (VAR) of signaldo > ' ;'
```

Related information

For information about	See
<i>Continuous Application Platform</i>	<i>Application manual - Continuous Application Platform</i>
InitSuperv instruction	InitSuperv - Reset all supervision for CAP on page 282
RemoveSuperv instruction	RemoveSuperv - Remove condition for one signal on page 605

1 Instructions

1.247 SiConnect - Sensor Interface Connect

Robot Reference Interface

Continued

```
! Setup Interface Procedure
PROC RRI_Open()
  SiConnect AnyDevice;
  ! Send and receive data cyclic with 64 ms rate
  SiGetCyclic AnyDevice, DataIn, SampleRate;
  SiSetCyclic AnyDevice, DataOut, SampleRate;
ENDPROC
```

When calling routine `RRI_Open`, first a connection to the device with name `AnyDevice` is opened. Then, cyclic transmission is started at rate `SampleRate`.

Example 2

```
PERS sensor AnyDevice;
...
SiConnect AnyDevice \NoStop;
! Send and receive data cyclic with 64 ms rate
SiGetCyclic AnyDevice, DataIn, SampleRate;
SiSetCyclic AnyDevice, DataOut, SampleRate;
...
TRAP sensorChange
  IF AnyDevice.state = STATE_ERROR THEN
    ...
  ENDIF
ENDTRAP
```

Establish a connection to the device called `AnyDevice` with the optional argument `\NoStop` preventing the system to stop if the connection to `AnyDevice` is broken. Handle error states in the trap routine.

Error handling

The following recoverable errors are generated and can be handled in an error handler. The system variable `ERRNO` will be set to:

Name	Cause of error
<code>ERR_COMM_INIT</code>	TCP is used as communication protocol and the connect operation fails.

If UDP is used as communication protocol no guarantees are given regarding the success of the connect operation and therefore no error handling is possible at the connect moment.

The switch `\NoStop` makes it possible to handle communication errors detected after a successful connect. `\NoStop` means that movements and execution of RAPID continues and that a trap routine can be used to handle specific errors using `IError` or specific state changes using `IPers`.



Note

`IPers` and `IError` are not safe interrupts, so if an error is detected after a stop, no trap routine will be executed. A way to handle this problem is to have a `SiConnect \NoStop` in the restart shelf, to be sure that the application tries to reestablish the connection to the client.

Continues on next page

Syntax

```
SiConnect
  [ Sensor ':=' ] < persistent ( PERS ) of sensor >
  [ '\ ' NoStop ] ';'

```

Related information

For information about	See
Close connection to an external system.	SiClose - Sensor Interface Close on page 724.
Register data for cyclic transmission.	SiSetCyclic - Sensor Interface Set Cyclic on page 732.
Subscribe on cyclic data transmission.	SiGetCyclic - Sensor Interface Get Cyclic on page 726
Descriptor to the external device.	sensor - External device descriptor on page 1738.
Communication state of a device.	sensorstate - Communication state of the device on page 1740.
<i>Robot Reference Interface</i>	<i>Application manual - Controller software IRC5</i>

1 Instructions

1.248 SiClose - Sensor Interface Close

1.248 SiClose - Sensor Interface Close

Usage

SiClose closes an existing connection to an external device.

Basic examples

Basic example of the instruction SiClose is illustrated below.

Example 1

```
PERS sensor AnyDevice;  
...  
SiClose AnyDevice;
```

Close the connection to the device called AnyDevice.

Arguments

SiClose Sensor

Sensor

Data type: sensor

The descriptor for the external device that should be closed. The argument is a persistent variable, and its name must be the same as the name specified as the client in the setup file *Settings.xml*.

Program execution

Closes an existing connection to the external device.

Error handling

The following recoverable errors are generated and can be handled in an error handler. The system variable `ERRNO` will be set to:

Name	Cause of error
ERR_COMM_INIT	TCP is used as communication protocol and the connect operation fails.

If UDP is used as communication protocol then there is no guarantee regarding the success of the close operation and therefore no error handling is possible.

Syntax

```
SiClose  
[ Sensor ':' = ] < persistent ( PERS ) of sensor > ' ; '
```

Related information

For information about	See
Establish a connection to an external system.	SiConnect - Sensor Interface Connect on page 721.
Register data for cyclic transmission.	SiSetCyclic - Sensor Interface Set Cyclic on page 732.
Subscribe on cyclic data transmission.	SiGetCyclic - Sensor Interface Get Cyclic on page 726.

Continues on next page

For information about	See
Descriptor to the external device.	sensor - External device descriptor on page 1738.
Communication state of a device.	sensorstate - Communication state of the device on page 1740.
<i>Robot Reference Interface</i>	<i>Application manual - Controller software IRC5</i>

1.249 SiGetCyclic - Sensor Interface Get Cyclic

Robot Reference Interface
Continued

```

PERS sensdata DataIn :=
  ["No", [0,0,0,0,0,0,0,0,0,0,0,0,0,0,0,0,0]];
VAR num SampleRate:=64;
...
! Setup Interface Procedure
PROC RRI_Open()
  SiConnect AnyDevice;
  ! Send and receive data cyclic with 64 ms rate
  SiGetCyclic AnyDevice, DataIn, SampleRate;
  SiSetCyclic AnyDevice, DataOut, SampleRate;
ENDPROC

```

When calling routine `RRI_Open`, first a connection to the device with name `AnyDevice` is opened. Then, cyclic transmission is started at rate `SampleRate`.

Syntax

```

SiGetCyclic
  [ Sensor ':= ' ] < persistent (PERS) of sensor > ', '
  [ Data ':= ' ] < persistent (PERS) of anytype > ', '
  [ Rate ':= ' ] < expression (IN) of num > ] ';'

```

Related information

For information about	See
Establish a connection to an external system.	SiConnect - Sensor Interface Connect on page 721.
Close connection to an external system.	SiClose - Sensor Interface Close on page 724.
Register data for cyclic transmission.	SiSetCyclic - Sensor Interface Set Cyclic on page 732.
Descriptor to the external device.	sensor - External device descriptor on page 1738.
Communication state of a device.	sensorstate - Communication state of the device on page 1740.
<i>Robot Reference Interface</i>	<i>Application manual - Controller software IRC5</i>

1 Instructions

1.250 SimCollision - Simulate a collision

RobotWare Base

1.250 SimCollision - Simulate a collision

Usage

`SimCollision` is used to simulate a collision. The instruction can be valuable when testing error handling for collisions.

Basic examples

The following example illustrates the instruction `SimCollision`.

Example 1

```
SimCollision;
```

Simulate a motion collision to test error handling.

Program execution

Execution of `SimCollision` will simulate a motion collision. The instruction can be valuable when testing error handling for motion collisions and should only be used for testing purposes. The instruction will generate an event log *41910, Collision simulated with instruction SimCollision*, when used.

Syntax

```
SimCollision';'
```

Related information

For information about	See
Settings for if error handling should be executed or not	<i>Technical reference manual - System parameters</i> , topic <i>Controller</i> , type <i>General RAPID</i> , <i>Collision-ErrorHandling</i>
<i>Collision Detection</i>	<i>Application manual - Controller software IRC5</i>

1.251 SingArea - Defines interpolation around singular points

Usage

`SingArea` is used to define how the robot is to move in the proximity of singular points.

`SingArea` is also used to define linear and circular interpolation for robots with less than six axes, and a six-axes robot can be programmed to run with axis 4 locked to 0 or ± 180 degrees.

This instruction can only be used in the main task `T_ROB1` or, if in a *MultiMove* system, in Motion tasks.

Basic examples

The following examples illustrate the instruction `SingArea`:

Example 1

```
SingArea \Wrist;
```

The orientation of the tool may be changed slightly to pass a singular point (axes 4 and 6 in line).

Robots with less than six axes may not be able to reach an interpolated tool orientation. By using `SingArea \Wrist` the robot can achieve the movement but the orientation of the tool will be slightly changed.

Example 2

```
SingArea \LockAxis4;
```

A six-axis robot can be programmed to run with axis 4 locked to 0 or ± 180 degrees to avoid singularity problems when axis 5 is close to 0.

The programmed position is reached with axis 4 locked to 0 or ± 180 degrees. If the position was not programmed with axis 4 at 0 or ± 180 degrees, it is now reached with a different tool orientation.

If the starting position of axis 4 deviates more than 2 degrees from the locked position, then the first movement will behave as if `SingArea` was called with the argument `\Wrist`.

Example 3

```
SingArea \Off;
```

The tool orientation is not allowed to differ from the programmed orientation. If a singular point is passed then one or more axes may perform a sweeping movement resulting in a reduction in TCP velocity.

Robots with less than six axes may not be able to reach a programmed tool orientation. As a result the robot will stop.

Arguments

```
SingArea [ \Wrist ] | [ \LockAxis4 ] | [ \Off ]
```

[\Wrist]

Data type: switch

Continues on next page

1 Instructions

1.251 SingArea - Defines interpolation around singular points

RobotWare Base

Continued

The tool orientation is allowed to differ somewhat to avoid wrist singularity. Used when axes 4 and 6 are parallel (axis 5 at 0 degrees). Also used for linear and circular interpolation of robots with less than six axes where the tool orientation is allowed to differ.

`[\LockAxis4]`

Data type: `switch`

The programmed position is reached with axis 4 locked to 0 or ± 180 degrees. If the position was not programmed with axis 4 at 0 or ± 180 degrees, it is now reached with a different tool orientation.

If the starting position of axis 4 deviates more than 2 degrees from the locked position, then the first movement will behave as if `SingArea` was called with the argument `\Wrist`.

`[\Off]`

Data type: `switch`

The tool orientation is not allowed to differ. Used when no singular points are passed or when the orientation is not permitted to be changed.

If none of the arguments are specified the system will be set to `\Off`.

Program execution

The specified interpolation applies for the next executed movement instruction until a new `SingArea` instruction is executed.

If the argument `\Wrist` is specified then the orientation is joint-interpolated to avoid singular points. In this way the TCP follows the correct path, but the orientation of the tool deviates somewhat. This will also happen when a singular point is not passed.

If the argument `\LockAxis4` is specified, then axis 4 is locked to 0 or ± 180 degrees to avoid singular points. The TCP will in general follow the correct path, but the orientation of the tool will deviate if the position was not programmed with axis 4 at 0 or ± 180 degrees. For paths with large reorientations, the TCP may deviate from the programmed linear path.

The movement is only affected on execution of linear or circular interpolation.

By default, program execution automatically uses the `Off` argument for robots with six axes. Robots with less than six axes may use either the `Off` argument or the `/Wrist` argument by default. This is automatically set in event routine `SYS_RESET`.

The default value is automatically set

- when using the restart mode **Reset RAPID**
- when loading a new program or a new module
- when starting program execution from the beginning
- when moving the program pointer to `main`
- when moving the program pointer to a routine
- when moving the program pointer in such a way that the execution order is lost.

Continues on next page

1.251 SingArea - Defines interpolation around singular points

RobotWare Base

Continued

Syntax

SingArea

```
[ '\ Wrist ] | [ '\ LockAxis4 ] | [ '\ Off ] ';' 
```

Related information

For information about	See
Singularity	<i>Technical reference manual - RAPID Overview</i>
Interpolation	<i>Technical reference manual - RAPID Overview</i>
Motion settings data	motsetdata - Motion settings data on page 1692

1 Instructions

1.252 SiSetCyclic - Sensor Interface Set Cyclic Robor Reference Interface

1.252 SiSetCyclic - Sensor Interface Set Cyclic

Usage

`SiSetCyclic` registers data for cyclic transmission to an external device.

Basic examples

A basic example of the instruction `SiSetCyclic` is illustrated below.

See also [More examples on page 732](#).

Example 1

```
PERS sensor AnyDevice;
PERS robdata DataOut := [[0,0,0,0,0,0,0,0,0,0,0,0,0,0,0,0]];
...
SiConnect AnyDevice;
SiSetCyclic AnyDevice, DataOut, 40;
```

Establish a connection to the device called `AnyDevice`. Then register data for cyclic transmission to the external device `AnyDevice` every 40 ms.

Arguments

`SiSetCyclic` Sensor Data Rate

Sensor

Data type: `sensor`

A descriptor for the external device to send data to.

Data

Data type: `anytype`

Reference to a persistent of any complex or supported simple type containing the data to be sent to the client specified in argument `Sensor`. The variable must be defined as *Writable* in the *Configuration.xml* file.

Rate

Data type: `num`

Transfer rate in milliseconds (only multiples of 4 ms are supported).

Program execution

Instruction `SiSetCyclic` registers data for cyclic transmission to an external device.

For `SiGetCyclic` and `SiSetCyclic` instructions, a transfer rate of 0 stops (unregisters / unsubscribes) the cyclic transmission of the given data or data set.

More examples

More examples of how to use the instruction `SiSetCyclic` are illustrated below.

Example 1

```
PERS sensor AnyDevice;
PERS robdata DataOut := [[0,0,0,0,0,0,0,0,0,0,0,0,0,0,0,0]];
```

Continues on next page

1.252 SiSetCyclic - Sensor Interface Set Cyclic

Robot Reference Interface

Continued

```

PERS sensdata DataIn :=
  ["No", [0,0,0,0,0,0,0,0,0,0,0,0,0,0,0,0,0,0]];
VAR num SampleRate:=64;
...
! Setup Interface Procedure
PROC RRI_Open()
  SiConnect AnyDevice;
  ! Send and receive data cyclic with 64 ms rate
  SiGetCyclic AnyDevice, DataIn, SampleRate;
  SiSetCyclic AnyDevice, DataOut, SampleRate;
ENDPROC

```

When calling routine `RRI_Open`, first a connection to the device with name `AnyDevice` is opened. Then, cyclic transmission is started at rate `SampleRate`.

Syntax

```

SiSetCyclic
  [ Sensor ':= ' ] < persistent (PERS) of sensor > ', '
  [ Data ':= ' ] < persistent (PERS) of anytype >
  [ Rate ':= ' ] < expression (IN) of num > ] ';'

```

Related information

For information about	See
Establish a connection to an external system.	SiConnect - Sensor Interface Connect on page 721.
Close connection to an external system.	SiClose - Sensor Interface Close on page 724.
Subscribe on cyclic data transmission.	SiGetCyclic - Sensor Interface Get Cyclic on page 726.
Descriptor to the external device.	sensor - External device descriptor on page 1738.
Communication state of a device.	sensorstate - Communication state of the device on page 1740.
<i>Robot Reference Interface</i>	<i>Application manual - Controller software IRC5</i>

1 Instructions

1.253 SkipWarn - Skip the latest warning

RobotWare Base

1.253 SkipWarn - Skip the latest warning

Usage

`SkipWarn`(*Skip Warning*) is used to skip the latest generated warning message to be stored in the Event Log during execution in running mode continuously or cycle (no warnings skipped in FWD or BWD step).

With `SkipWarn` it is possible to repeatedly do error recovery in RAPID without filling the Event Log with only warning messages.

Basic examples

The following example illustrates the instruction `SkipWarn`:

Example 1

```
%"notexistingproc"%;  
nextinstruction;  
ERROR  
IF ERRNO = ERR_REFUNKPRC THEN  
  SkipWarn;  
  TRYNEXT;  
ENDIF  
ENDPROC
```

The program will execute the `nextinstruction` and no warning message will be stored in the Event Log.

Syntax

```
SkipWarn ' ; '
```

Related information

For information about	See
Error recovery	<i>Technical reference manual - RAPID Overview</i> <i>Technical reference manual - RAPID Overview</i>
Error number	errnum - Error number on page 1653

1.254 SocketAccept - Accept an incoming connection

Usage

SocketAccept is used to accept incoming connection requests. SocketAccept can only be used for server applications.

Basic examples

The following example illustrates the instruction SocketAccept:

See also [More examples on page 736](#).

Example 1

```
VAR socketdev server_socket;
VAR socketdev client_socket;
...
SocketCreate server_socket;
SocketBind server_socket, "192.168.0.1", 1025;
SocketListen server_socket;
SocketAccept server_socket, client_socket;
```

A server socket is created and bound to port 1025 on the controller network address 192.168.0.1. After execution of SocketListen the server socket starts to listen for incoming connections on this port and address. SocketAccept waits for any incoming connections, accepts the connection request, and returns a client socket for the established connection.

Arguments

```
SocketAccept Socket ClientSocket [\ClientAddress] [ \Time ]
```

Socket

Data type: socketdev

The server socket that are waiting for incoming connections. The socket must already be created, bounded, and ready for listening.

ClientSocket

Data type: socketdev

The returned new client socket that will be updated with the accepted incoming connection request.

[\ClientAddress]

Data type: string

The variable that will be updated with the IP-address of the accepted incoming connection request.

[\Time]

Data type: num

The maximum amount of time [s] that program execution waits for incoming connections. If this time runs out before any incoming connection then the error handler will be called, if there is one, with the error code ERR_SOCK_TIMEOUT. If there is no error handler then the execution will be stopped.

Continues on next page

1 Instructions

1.254 SocketAccept - Accept an incoming connection

Socket Messaging

Continued

If parameter `\Time` is not used then the waiting time is 60 s. To wait forever, use the predefined constant `WAIT_MAX`.

Program execution

The server socket will wait for any incoming connection requests. When accepting the incoming connection request the instruction is ready and the returned client socket is by default connected and can be used in `SocketSend` and `SocketReceive` instructions.

Error handling

The following recoverable errors are generated and can be handled in an error handler. The system variable `ERRNO` will be set to:

Name	Cause of error
<code>ERR_SOCKET_CLOSED</code>	The socket is closed (has been closed or is not created). Use <code>SocketCreate</code> to create a new socket.
<code>ERR_SOCKET_EXEC_LEVEL</code>	Use of socket instructions on different RAPID execution levels at the same time, that is, normal execution level and TRAP level.
<code>ERR_SOCKET_TIMEOUT</code>	The connection was not established within the time out time
<code>ERR_SOCKET_UNSPEC</code>	Unspecified exception from underlying call to the operating system.

More examples

More examples of the instruction `SocketAccept` are illustrated below.

Example 1

```
VAR socketdev server_socket;
VAR socketdev client_socket;
VAR string receive_string;
VAR string client_ip;
...
SocketCreate server_socket;
SocketBind server_socket, "192.168.0.1", 1025;
SocketListen server_socket;
WHILE TRUE DO
  SocketAccept server_socket, client_socket
    \ClientAddress:=client_ip;
  SocketReceive client_socket \Str := receive_string;
  SocketSend client_socket \Str := "Hello client with ip-address
    " +client_ip;
  ! Wait for client acknowledge
  ...
  SocketClose client_socket;
ENDWHILE
ERROR
  RETRY;
UNDO
  SocketClose server_socket;
  SocketClose client_socket;
```

Continues on next page

A server socket is created and bound to port 1025 on the controller network address 192.168.0.1. After execution of `SocketListen` the server socket starts to listen for incoming connections on this port and address. `SocketAccept` will accept the incoming connection from some client and store the client address in the string `client_ip`. Then the server receives a string message from the client and stores the message in `receive_string`. Then the server responds with the message "Hello client with ip-address xxx.xxx.x.x" and closes the client connection.

After that the server is ready for a connection from the same or some other client in the `WHILE` loop. If `PP` is moved to main in the program then all open sockets are closed (`SocketClose` can always be done even if the socket is not created).

Syntax

```
SocketAccept
  [Socket ':'=''] <variable (VAR) of socketdev>','
  [ClientSocket ':'=''] <variable (VAR) of socketdev>
  ['\' ClientAddress ':'=''] <variable (VAR) of string>]
  ['\' Time ':'=''] <expression (IN) of num>]';'
```

Related information

For information about	See
Socket communication in general	<i>Application manual - Controller software IRC5, section Socket Messaging</i>
Create a new socket	SocketCreate - Create a new socket on page 745
Connect to remote computer (only client)	SocketConnect - Connect to a remote computer on page 742
Send data to remote computer	SocketSend - Send data to remote computer on page 759
Receive data from remote computer	SocketReceive - Receive data from remote computer on page 749
Close the socket	SocketClose - Close a socket on page 740
Bind a socket (only server)	SocketBind - Bind a socket to my IP-address and port on page 738
Listening connections (only server)	SocketListen - Listen for incoming connections on page 747
Get current socket state	SocketGetStatus - Get current socket state on page 1462
Example client socket application	SocketSend - Send data to remote computer on page 759
Example of server socket application	SocketReceive - Receive data from remote computer on page 749

1 Instructions

1.255 SocketBind - Bind a socket to my IP-address and port

Socket Messaging

1.255 SocketBind - Bind a socket to my IP-address and port

Usage

SocketBind is used to bind a socket to the specified server IP-address and port number. SocketBind can only be used for server applications.

Basic examples

The following example illustrates the instruction SocketBind:

Example 1

```
VAR socketdev server_socket;  
  
SocketCreate server_socket;  
SocketBind server_socket, "192.168.0.1", 1025;
```

A server socket is created and bound to port 1025 on the controller network address 192.168.0.1. The server socket can now be used in an SocketListen instruction to listen for incoming connections on this port and address.

Arguments

```
SocketBind Socket LocalAddress LocalPort
```

Socket

Data type: socketdev

The server socket to bind. The socket must be created but not already bound.

LocalAddress

Data type: string

The server network address to bind the socket to. The only valid addresses are any public WAN addresses or the controller service port address 192.168.125.1.

LocalPort

Data type: num

The server port number to bind the socket to. Generally ports 1025-4999 are free to use.

Program execution

The server socket is bound to the specified server port and IP-address.

An error is generated if the specified port is already in use.

Use the SocketBind and SocketListen instructions in the startup of the program to associate a local address with a socket and then listen for incoming connections on the specified port. This is recommended to do only once for each socket and port that is used (TCP/IP).

Use the SocketBind instruction if receiving data with SocketReceiveFrom (UDP/IP).

Continues on next page

Error handling

The following recoverable errors are generated and can be handled in an error handler. The system variable `ERRNO` will be set to:

Name	Cause of error
<code>ERR_SOCKET_ADDR_INVALID</code>	The specified address is invalid.
<code>ERR_SOCKET_ADDR_INUSE</code>	The address and port is already in use and cannot be used again. Use a different port number.
<code>ERR_SOCKET_EXEC_LEVEL</code>	Use of socket instructions on different RAPID execution levels at the same time, that is, normal execution level and TRAP level.
<code>ERR_SOCKET_IS_BOUND</code>	The socket has already been bound to an address and cannot be bound again.
<code>ERR_SOCKET_CLOSED</code>	The socket is closed (has been closed or is not created) Use <code>SocketCreate</code> to create a new socket.
<code>ERR_SOCKET_UNSPEC</code>	Unspecified exception from underlying call to the operating system.

Syntax

```
SocketBind
  [Socket ':='] <variable (VAR) of socketdev>','
  [LocalAddress ':='] <expression (IN) of string>','
  [LocalPort ':='] <expression (IN) of num>;'
```

Related information

For information about	See
Socket communication in general	Application manual - Controller software IRC5
Create a new socket	SocketCreate - Create a new socket on page 745
Connect to remote computer (only client)	SocketConnect - Connect to a remote computer on page 742
Send data to remote computer	SocketSend - Send data to remote computer on page 759
Receive data from remote computer	SocketReceive - Receive data from remote computer on page 749
Close the socket	SocketClose - Close a socket on page 740
Listening connections (only server)	SocketListen - Listen for incoming connections on page 747
Accept connections (only server)	SocketAccept - Accept an incoming connection on page 735
Get current socket state	SocketGetStatus - Get current socket state on page 1462
Example client socket application	SocketSend - Send data to remote computer on page 759
Example server socket application	SocketReceive - Receive data from remote computer on page 749
Receive data from remote computer	SocketReceiveFrom - Receive data from remote computer on page 754

1 Instructions

1.256 SocketClose - Close a socket
Socket Messaging

1.256 SocketClose - Close a socket

Usage

SocketClose is used when a socket connection is no longer going to be used. After a socket has been closed it cannot be used in any socket call except SocketCreate.

Basic examples

The following example illustrates the instruction SocketClose:

Example 1

```
SocketClose socket1;
```

The socket is closed and cannot be used anymore.

Arguments

```
SocketClose Socket
```

Socket

Data type: socketdev

The socket to be closed.

Program execution

The socket will be closed and its allocated resources will be released. Any socket can be closed at any time. The socket cannot be used after closing. It can be reused for a new connection after a call to SocketCreate.

Limitations

Closing the socket connection immediately after sending the data with SocketSend can lead to loss of sent data. This is because TCP/IP socket has built-in functionality to resend the data if there is some communication problem.

To avoid such problems with loss of data, do the following before SocketClose:

- handshake the shutdown or
- WaitTime 2

Avoid fast loops with SocketCreate ... SocketClose, because the socket is not really closed until a certain time (TCP/IP functionality).

Syntax

```
SocketClose  
[Socket ':='] <variable (VAR) of socketdev>;'
```

Related information

For information about	See
Socket communication in general	<i>Application manual - Controller software IRC5, section Socket Messaging</i>
Create a new socket	SocketCreate - Create a new socket on page 745

Continues on next page

For information about	See
Connect to a remote computer (only client)	SocketConnect - Connect to a remote computer on page 742
Send data to remote computer	SocketSend - Send data to remote computer on page 759
Receive data from remote computer	SocketReceive - Receive data from remote computer on page 749
Bind a socket (only server)	SocketBind - Bind a socket to my IP-address and port on page 738
Listening connections (only server)	SocketListen - Listen for incoming connections on page 747
Accept connections (only server)	SocketAccept - Accept an incoming connection on page 735
Get current socket state	SocketGetStatus - Get current socket state on page 1462
Example client socket application	SocketSend - Send data to remote computer on page 759
Send data to remote computer	SocketSendTo - Send data to remote computer on page 763
Example server socket application	SocketReceive - Receive data from remote computer on page 749
Receive data from remote computer	SocketReceiveFrom - Receive data from remote computer on page 754

1 Instructions

1.257 SocketConnect - Connect to a remote computer

Socket Messaging

1.257 SocketConnect - Connect to a remote computer

Usage

`SocketConnect` is used to connect the socket to a remote computer in a client application.

Basic examples

The following example illustrates the instruction `SocketConnect`:

See also [More examples on page 743](#).

Example 1

```
SocketConnect socket1, "192.168.0.1", 1025;
```

Trying to connect to a remote computer at ip-address `192.168.0.1` and port `1025`.

Arguments

```
SocketConnect Socket Address Port [\Time]
```

Socket

Data type: `socketdev`

The client socket to connect. The socket must be created but not already connected.

Address

Data type: `string`

The address of the remote computer. The remote computer must be specified as an IP address. It is not possible to use the name of the remote computer.

Port

Data type: `num`

The port on the remote computer. Generally ports 1025-4999 are free to use. Ports below 1025 can already be taken.

[\Time]

Data type: `num`

The maximum amount of time [s] that program execution waits for the connection to be accepted or denied. If this time runs out before the condition is met then the error handler will be called, if there is one, with the error code `ERR_SOCK_TIMEOUT`. If there is no error handler then the execution will be stopped.

If parameter `\Time` is not used the waiting time is 60 s. To wait forever, use the predefined constant `WAIT_MAX`.

Program execution

The socket tries to connect to the remote computer on the specified address and port. The program execution will wait until the connection is established, failed, or a timeout occurs.

Continues on next page

Error handling

The following recoverable errors are generated and can be handled in an error handler. The system variable `ERRNO` will be set to:

Name	Cause of error
<code>ERR_SOCK_ADDR_INVALID</code>	The specified address is invalid
<code>ERR_SOCK_CLOSED</code>	The socket is closed (has been closed or is not created). Use <code>SocketCreate</code> to create a new socket.
<code>ERR_SOCK_EXEC_LEVEL</code>	Use of socket instructions on different RAPID execution levels at the same time, that is, normal execution level and TRAP level.
<code>ERR_SOCK_IS_CONN</code>	The socket is connected.
<code>ERR_SOCK_NET_UNREACH</code>	Network is unreachable or connection is lost after a socket is opened.
<code>ERR_SOCK_TIMEOUT</code>	The connection was not established within the time-out time.
<code>ERR_SOCK_UNSPEC</code>	Unspecified exception from underlying call to the operating system.

More examples

More examples of the instruction `SocketConnect` are illustrated below.

Example 1

```

VAR num retry_no := 0;
VAR socketdev my_socket;
...
SocketCreate my_socket;
SocketConnect my_socket, "192.168.0.1", 1025;
...
ERROR
  IF ERRNO = ERR_SOCK_TIMEOUT THEN
    IF retry_no < 5 THEN
      WaitTime 1;
      retry_no := retry_no + 1;
      RETRY;
    ELSE
      RAISE;
    ENDIF
  ENDIF

```

A socket is created and tries to connect to a remote computer. If the connection is not established within the default time-out time, i.e. 60 seconds, then the error handler retries to connect. Four retries are attempted then the error is reported to the user.

Syntax

```

SocketConnect
  [Socket ':='] <variable (VAR) of socketdev>', '
  [Address ':='] <expression (IN) of string>', '
  [Port ':='] <expression (IN) of num>
  ['\ ' Time ':=' <expression (IN) of num>'];'

```

Continues on next page

1 Instructions

1.257 SocketConnect - Connect to a remote computer

Socket Messaging

Continued

Related information

For information about	Described in:
Socket communication in general	Application manual - Controller software IRC5
Create a new socket	SocketCreate - Create a new socket on page 745
Send data to remote computer	SocketSend - Send data to remote computer on page 759
Receive data from remote computer	SocketReceive - Receive data from remote computer on page 749
Bind a socket (only server)	SocketBind - Bind a socket to my IP-address and port on page 738
Listening connections (only server)	SocketListen - Listen for incoming connections on page 747
Accept connections (only server)	SocketAccept - Accept an incoming connection on page 735
Get current socket state	SocketGetStatus - Get current socket state on page 1462
Example client socket application	SocketSend - Send data to remote computer on page 759
Example server socket application	SocketReceive - Receive data from remote computer on page 749

1.258 SocketCreate - Create a new socket

Usage

`SocketCreate` is used to create a new socket for connection based communication or connectionless communication.

Both socket messaging of stream type protocol TCP/IP with delivery guarantee and datagram protocol UDP/IP is supported. Both server and client application can be developed. For datagram protocol UDP/IP, broadcast is supported.

Basic examples

The following examples illustrate the instruction `SocketCreate`:

Example 1

```
VAR socketdev socket1;
...
SocketCreate socket1;
```

A new socket device using stream type protocol TCP/IP is created and assigned into the variable `socket1`.

Example 2

```
VAR socketdev udp_sock1;
...
SocketCreate udp_sock1 \UDP;
```

A new socket device using datagram protocol UDP/IP is created and assigned into the variable `udp_sock1`.

Arguments

```
SocketCreate Socket [\UDP]
```

Socket

Data type: `socketdev`

The variable for storage of the system's internal socket data.

[\UDP]

Data type: `switch`

Specifies that the socket should be of the type datagram protocol UDP/IP.

Program execution

The instruction creates a new socket device.

The socket must not already be in use. The socket is in use between `SocketCreate` and `SocketClose`.

Error handling

The following recoverable errors are generated and can be handled in an error handler. The system variable `ERRNO` will be set to:

Name	Cause of error
<code>ERR_SOCK_UNSPEC</code>	Unspecified exception from underlying call to the operating system.

Continues on next page

1 Instructions

1.258 SocketCreate - Create a new socket

Socket Messaging

Continued

Limitations

Any number of sockets can be declared but it is only possible to use 32 sockets at the same time.

Avoid fast loops with `SocketCreate ... SocketClose`, because the socket is not really closed until after a certain time (when using TCP/IP functionality).

Syntax

```
SocketCreate  
  [Socket ':'='] <variable (VAR) of socketdev>  
  ['\' UDP']';'
```

Related information

For information about	See
Socket communication in general	Application manual - Controller software IRC5, section Socket Messaging
Connect to remote computer (only client)	SocketConnect - Connect to a remote computer on page 742
Send data to remote computer	SocketSend - Send data to remote computer on page 759
Receive data from remote computer	SocketReceive - Receive data from remote computer on page 749
Close the socket	SocketClose - Close a socket on page 740
Bind a socket (only server)	SocketBind - Bind a socket to my IP-address and port on page 738
Listening connections (only server)	SocketListen - Listen for incoming connections on page 747
Accept connections (only server)	SocketAccept - Accept an incoming connection on page 735
Get current socket state	SocketGetStatus - Get current socket state on page 1462
Example client socket application	SocketSend - Send data to remote computer on page 759
Send data to remote computer	SocketSendTo - Send data to remote computer on page 763
Example server socket application	SocketReceive - Receive data from remote computer on page 749
Receive data from remote computer	SocketReceiveFrom - Receive data from remote computer on page 754

1.259 SocketListen - Listen for incoming connections

Usage

`SocketListen` is used to start listening for incoming connections, i.e. start acting as a server. `SocketListen` can only be used for server applications.

Basic examples

The following example illustrates the instruction `SocketListen`:

Example 1

```
VAR socketdev server_socket;
VAR socketdev client_socket;
...
SocketCreate server_socket;
SocketBind server_socket, "192.168.0.1", 1025;
SocketListen server_socket;
WHILE listening DO;
    ! Waiting for a connection request
    SocketAccept server_socket, client_socket;
```

A server socket is created and bound to port 1025 on the controller network address 192.168.0.1. After execution of `SocketListen` the server socket starts to listen for incoming connections on this port and address.

Arguments

`SocketListen` `Socket`

`Socket`

Data type: `socketdev`

The server socket that should start listening for incoming connections. The socket must already be created and bound.

Program execution

The server socket starts listening for incoming connections. When the instruction is ready the socket is ready to accept an incoming connection.

Use the `SocketBind` and `SocketListen` instructions in the startup of the program to associate a local address with a socket and then listen for incoming connections on the specified port. This is recommended to do only once for each socket and port that is used.

Error handling

The following recoverable errors are generated and can be handled in an error handler. The system variable `ERRNO` will be set to:

Name	Cause of error
<code>ERR_SOCKET_CLOSED</code>	The socket is closed (has been closed or is not created). Use <code>SocketCreate</code> to create a new socket.
<code>ERR_SOCKET_IS_CONN</code>	The socket is connected.
<code>ERR_SOCKET_NOT_BOUND</code>	The socket has not been bound to an address.

Continues on next page

1 Instructions

1.259 SocketListen - Listen for incoming connections

Socket Messaging

Continued

Name	Cause of error
ERR_SOCK_UNSPEC	Unspecified exception from underlying call to the operating system.

Syntax

```
SocketListen  
  [Socket ':='] <variable (VAR) of socketdev>;'
```

Related information

For information about	See
Socket communication in general	Application manual - Controller software IRC5
Create a new socket	SocketCreate - Create a new socket on page 745
Connect to remote computer (only client)	SocketConnect - Connect to a remote computer on page 742
Send data to remote computer	SocketSend - Send data to remote computer on page 759
Receive data from remote computer	SocketReceive - Receive data from remote computer on page 749
Close the socket	SocketClose - Close a socket on page 740
Bind a socket (only server)	SocketBind - Bind a socket to my IP-address and port on page 738
Accept connections (only server)	SocketAccept - Accept an incoming connection on page 735
Get current socket state	SocketGetStatus - Get current socket state on page 1462
Example client socket application	SocketSend - Send data to remote computer on page 759
Example server socket application	SocketReceive - Receive data from remote computer on page 749

1.260 SocketReceive - Receive data from remote computer

Usage

SocketReceive is used for receiving data from a remote computer.
SocketReceive can be used both for client and server applications.

Basic examples

The following example illustrates the instruction SocketReceive:
See also [More examples on page 751](#).

Example 1

```
VAR string str_data;
...
SocketReceive socket1 \Str := str_data;
```

Receive data from a remote computer and store it in the string variable str_data.

Arguments

```
SocketReceive Socket [ \Str ] | [ \RawData ] | [ \Data ]
                [\ReadNoOfBytes] [\NoRecBytes] [\Time]
```

Socket

Data type: socketdev

In a client application where the socket receives the data, the socket must already be created and connected.

In a server application where the socket receives the data, the socket must already be accepted.

[\Str]

Data type: string

The variable in which the received string data should be stored.

The string length is limited to 80 characters.

[\RawData]

Data type: rawbytes

The variable in which the received rawbytes data should be stored. Max. number of rawbytes 1024 can be handled.

[\Data]

Data type: array of byte

The variable in which the received byte data should be stored. Max. number of byte 1024 can be handled.

Only one of the optional parameters \Str, \RawData, and \Data can be used at the same time.

[\ReadNoOfBytes]

Read number of Bytes

Data type: num

Continues on next page

1 Instructions

1.260 SocketReceive - Receive data from remote computer

Socket Messaging

Continued

The number of bytes to read. The minimum value of bytes to read is 1, and the maximum amount is the value of the size of the data type used, i.e. 80 bytes if using a variable of the data type `string`.

If communicating with a client that always sends a fixed number of bytes, this optional parameter can be used to specify that the same amount of bytes should be read for each `SocketReceive` instruction.

If the sender sends `RawData`, the receiver needs to specify that 4 bytes should be received for each `rawbytes` sent.

[`\NoRecBytes`]

Number Received Bytes

Data type: `num`

Variable for storage of the number of bytes needed from the specified `socketdev`.

The same result can also be achieved with

- function `StrLen` on variable in argument `\Str`
- function `RawBytesLen` on variable in argument `\RawData`

[`\Time`]

Data type: `num`

The maximum amount of time [s] that program execution waits for the data to be received. If this time runs out before the data is transferred then the error handler will be called, if there is one, with the error code `ERR SOCK TIMEOUT`. If there is no error handler then the execution will be stopped.

If parameter `\Time` is not used then the waiting time is 60 s. To wait forever, use the predefined constant `WAIT_MAX`.

Program execution

The execution of `SocketReceive` will wait until the data is available or fail with a timeout error.

The amount of bytes read is specified by the data type used in the instruction. If using a `string` data type to receive data in, 80 bytes is received if there is 80 bytes that can be read. If using optional argument `ReadNoOfBytes` the user can specify how many bytes that should be received for each `SocketReceive`.

The data that is transferred on the cable is always bytes, max. 1024 bytes in one message. No header is added by default to the message. The usage of any header is reserved for the actual application.

Parameter	Input data	Cable data	Output data
<code>\Str</code>	1 char	1 byte (8 bits)	1 char
<code>\RawData</code>	1 rawbytes	1 byte (8 bits)	1 rawbytes
<code>\Data</code>	1 byte	1 byte (8 bits)	1 byte

It is possible to mix the used data type (`string`, `rawbytes`, or `array of byte`) between `SocketSend` and `SocketReceive`.

Continues on next page

Error handling

The following recoverable errors are generated and can be handled in an error handler. The system variable `ERRNO` will be set to:

Name	Cause of error
<code>ERR_SOCK_CLOSED</code>	The socket is closed. Broken connection.
<code>ERR_SOCK_EXEC_LEVEL</code>	Use of socket instructions on different RAPID execution levels at the same time, that is, normal execution level and TRAP level.
<code>ERR_SOCK_NET_UNREACH</code>	Network is unreachable or connection is lost after a socket is opened.
<code>ERR_SOCK_NOT_CONN</code>	The socket is not connected
<code>ERR_SOCK_TIMEOUT</code>	No data was received within the time out time.

More examples

More examples of the instruction `SocketReceive` are illustrated below.

Example 1

```

VAR socketdev server_socket;
VAR socketdev client_socket;
VAR string client_ip;

PROC server_messaging()
  VAR string receive_string;
  ...
  ! Create, bind, listen and accept of sockets in error handlers
  SocketReceive client_socket \Str := receive_string;
  SocketSend client_socket \Str := "Hello client with
    ip-address"+client_ip;
  ! Wait for acknowlegde from client
  ...
  SocketClose server_socket;
  SocketClose client_socket;
ERROR
  IF ERRNO=ERR_SOCK_TIMEOUT THEN
    RETRY;
  ELSEIF ERRNO=ERR_SOCK_CLOSED THEN
    server_recover;
    RETRY;
  ELSE
    ! No error recovery handling
  ENDIF
ENDPROC

PROC server_recover()
  SocketClose server_socket;
  SocketClose client_socket;
  SocketCreate server_socket;
  SocketBind server_socket, "192.168.0.1", 1025;
  SocketListen server_socket;

```

Continues on next page

1 Instructions

1.260 SocketReceive - Receive data from remote computer

Socket Messaging

Continued

```
SocketAccept server_socket,  
             client_socket\ClientAddress:=client_ip;  
ERROR  
IF ERRNO=ERR_SOCK_TIMEOUT THEN  
    RETRY;  
ELSEIF ERRNO=ERR_SOCK_CLOSED THEN  
    RETURN;  
ELSE  
    ! No error recovery handling  
ENDIF  
ENDPROC
```

This is an example of a server program with creation, binding, listening, and accepting of sockets in error handlers. In this way the program can handle power fail restart.

In the procedure `server_recover`, a server socket is created and bound to port 1025 on the controller network address 192.168.0.1. After execution of `SocketListen` the server socket starts to listen for incoming connections on this port and address. `SocketAccept` will accept the incoming connection from some client and store the client address in the string `client_ip`.

In the communication procedure `server_messaging` the server receives a string message from the client and stores the message in `receive_string`. Then the server responds with the message "Hello client with ip-address xxx.xxx.x.x".

Limitations

There is no built-in synchronization mechanism in Socket Messaging to avoid received messages that are compounded of several sent messages. It is up to the programmer to handle the synchronization with "Ack" messages (one sequence of `SocketSend` - `SocketReceive` in the client or server program must be completed before next sequence of `SocketSend` - `SocketReceive`).

All sockets are closed after power fail restart. This problem can be handled by error recovery. See example above.

Avoid fast loops with `SocketCreate` ... `SocketClose` because the socket is not really closed until a certain time (TCP/IP functionality).

The maximum size of the data that can be received in one call is limited to 1024 bytes.

Syntax

```
SocketReceive  
[Socket ':='] <variable (VAR) of socketdev>  
['\ Str ':=' <variable (VAR) of string>]  
[['\ RawData ':=' <variable (VAR) of rawbytes>]  
[['\ Data ':=' <array {*} (VAR) of byte>]  
['\ ReadNoOfBytes ':=' <expression (IN) of num>]  
['\ NoRecBytes ':=' <variable (VAR) of num>]  
['\ Time ':=' <expression (IN) of num>]';'
```

Continues on next page

Related information

For information about	See
Socket communication in general	Application manual - Controller software IRC5
Create a new socket	SocketCreate - Create a new socket on page 745
Connect to remote computer (only client)	SocketConnect - Connect to a remote computer on page 742
Send data to remote computer	SocketSend - Send data to remote computer on page 759
Close the socket	SocketClose - Close a socket on page 740
Bind a socket (only server)	SocketBind - Bind a socket to my IP-address and port on page 738
Listening connections (only server)	SocketListen - Listen for incoming connections on page 747
Accept connections (only server)	SocketAccept - Accept an incoming connection on page 735
Get current socket state	SocketGetStatus - Get current socket state on page 1462
Example client socket application	SocketSend - Send data to remote computer on page 759
Test for the presence of data on a socket.	SocketPeek - Test for the presence of data on a socket on page 1465

1 Instructions

1.261 SocketReceiveFrom - Receive data from remote computer

Socket Messaging

1.261 SocketReceiveFrom - Receive data from remote computer

Usage

SocketReceiveFrom is used for receiving data from a remote computer. SocketReceiveFrom can be used both for client and server applications. SocketReceiveFrom is used for connectionless communication with datagram protocol UDP/IP.

Basic examples

The following example illustrates the instruction SocketReceiveFrom:

See also [More examples on page 751](#).

Example 1

```
VAR string str_data;
VAR string RemoteAddress;
VAR num RemotePort;
...
SocketCreate \UDP;
SocketBind myUDPsock, "192.168.9.100", 4044;
SocketReceiveFrom socket1 \Str := str_data, RemoteAddress,
RemotePort;
```

Receive data from a remote computer and store it in the string variable `str_data`. The address of the remote computer is stored in the string variable `RemoteAddress` and the port number is stored in the num variable `RemotePort`.

Arguments

```
SocketReceiveFrom Socket [ \Str ] | [ \RawData ] | [ \Data ]
[\ReadNoOfBytes] [\NoRecBytes] RemoteAddress RemotePort
[\Time]
```

Socket

Data type: `socketdev`

A socket device identifying a bound socket.

[\Str]

Data type: `string`

The variable in which the received `string` data should be stored.

The string length is limited to 80 characters.

[\RawData]

Data type: `rawbytes`

The variable in which the received `rawbytes` data should be stored. Max. number of `rawbytes` 1024 can be handled.

[\Data]

Data type: `array of byte`

The variable in which the received `byte` data should be stored. Max. number of `byte` 1024 can be handled.

Continues on next page

1.261 SocketReceiveFrom - Receive data from remote computer

Socket Messaging

Continued

Only one of the optional parameters `\Str`, `\RawData`, and `\Data` can be used at the same time.

[`\ReadNoOfBytes`]

Read number of Bytes

Data type: `num`

The number of bytes to read. The minimum value of bytes to read is 1, and the maximum amount is the value of the size of the data type used, i.e. 80 bytes if using a variable of the data type `string`.

If communicating with a client that always sends a fixed number of bytes, this optional parameter can be used to specify that the same amount of bytes should be read for each `SocketReceive` instruction.

If the sender sends `RawData`, the receiver needs to specify that 4 bytes should be received for each `rawbytes` sent.

[`\NoRecBytes`]

Number Received Bytes

Data type: `num`

Variable for storage of the number of bytes needed from the specified `socketdev`.

The same result can also be achieved with

- function `StrLen` on variable in argument `\Str`
- function `RawBytesLen` on variable in argument `\RawData`

`RemoteAddress`

Data type: `string`

A string variable containing the source address of the remote computer.

`RemotePort`

Data type: `num`

A num variable containing the port used by the remote computer when sending the datagram package.

[`\Time`]

Data type: `num`

The maximum amount of time [s] that program execution waits for the data to be received. If this time runs out before the data is transferred then the error handler will be called, if there is one, with the error code `ERR_SOCK_TIMEOUT`. If there is no error handler then the execution will be stopped.

If parameter `\Time` is not used then the waiting time is 60 s. To wait forever, use the predefined constant `WAIT_MAX`.

Program execution

The execution of `SocketReceiveFrom` receives a datagram and stores the source address and source port. It will wait until the data is available or fail with a timeout error.

Continues on next page

1 Instructions

1.261 SocketReceiveFrom - Receive data from remote computer

Socket Messaging

Continued

The amount of bytes read is specified by the data type used in the instruction. If using a `string` data type to receive data in, 80 bytes is received if there is 80 bytes that can be read.

The data that is transferred on the cable is always bytes, max. 1024 bytes in one message. No header is added by default to the message. The usage of any header is reserved for the actual application.

Parameter	Input data	Cable data	Output data
<code>\Str</code>	1 char	1 byte (8 bits)	1 char
<code>\RawData</code>	1 rawbytes	1 byte (8 bits)	1 rawbytes
<code>\Data</code>	1 byte	1 byte (8 bits)	1 byte

It is possible to mix the used data type (`string`, `rawbytes`, or `array of byte`) between `SocketSendTo` and `SocketReceiveFrom`.

Error handling

The following recoverable errors are generated and can be handled in an error handler. The system variable `ERRNO` will be set to:

Name	Cause of error
<code>ERR_SOCKET_CLOSED</code>	The socket is closed.
<code>ERR_SOCKET_EXEC_LEVEL</code>	Use of socket instructions on different RAPID execution levels at the same time, that is, normal execution level and TRAP level.
<code>ERR_SOCKET_NET_UNREACH</code>	Network is unreachable or connection is lost after a socket is opened.
<code>ERR_SOCKET_NOT_BOUND</code>	The socket has not been bound to an address.
<code>ERR_SOCKET_TIMEOUT</code>	No data was received within the time out time.

More examples

More examples of the instruction `SocketReceiveFrom` are illustrated below.

Example 1

```
VAR socketdev udp_socket;
VAR string client_ip;
VAR num client_port;

PROC server_messaging()
  VAR string receive_string;
  ...
  ! Create and bind of sockets in error handlers
  SocketReceiveFrom udp_socket \Str := receive_string, client_ip,
    client_port;
  SocketSendTo udp_socket, client_ip, client_port \Str := "Hello
    client with ip-address"+client_ip;
  ...
  SocketClose udp_socket;
```

Continues on next page

1.261 SocketReceiveFrom - Receive data from remote computer

Socket Messaging

Continued

```
ERROR
  IF ERRNO=ERR_SOCK_TIMEOUT THEN
    RETRY;
  ELSEIF ERRNO=SOCK_CLOSED THEN
    messaging_recover;
    RETRY;
  ELSE
    ! No error recovery handling
  ENDIF
ENDPROC

PROC messaging_recover()
  SocketClose udp_socket;
  SocketCreate udp_socket \UDP;
  SocketBind udp_socket, "192.168.0.1", 1025;
ERROR
  IF ERRNO=ERR_SOCK_CLOSED THEN
    RETURN;
  ELSE
    ! No error recovery handling
  ENDIF
ENDPROC
```

This is an example of a server program with creation and binding of sockets in error handlers. In this way the program can handle power fail restart.

In the communication procedure `server_messaging` the server receives a string message from the client and stores the message in `receive_string`. Then the server responds with the message "Hello client with ip-address xxx.xxx.x.x".

Limitations

All sockets are closed after power fail restart. This problem can be handled by error recovery. See example above.

The maximum size of the data that can be received in one call is limited to 1024 bytes.

Syntax

```
SocketReceiveFrom
  [Socket ':='] <variable (VAR) of socketdev>
  ['\ Str ':='] <variable (VAR) of string>]
  [['\ RawData ':='] <variable (VAR) of rawbytes>]
  [['\ Data ':='] <array {*} (VAR) of byte>]
  ['\ ReadNoOfBytes ':='] <expression (IN) of num>]
  ['\ NoRecBytes ':='] <variable (VAR) of num>]
  [RemoteAddress ':='] <variable (VAR) of string>
  [RemotePort ':='] <variable (VAR) of num>
  ['\ Time ':='] <expression (IN) of num>];'
```

Continues on next page

1 Instructions

1.261 SocketReceiveFrom - Receive data from remote computer

Socket Messaging

Continued

Related information

For information about	See
Socket communication in general	Application manual - Controller software IRC5
Create a new socket	SocketCreate - Create a new socket on page 745
Connect to remote computer (only client)	SocketConnect - Connect to a remote computer on page 742
Send data to remote computer	SocketSend - Send data to remote computer on page 759
Close the socket	SocketClose - Close a socket on page 740
Bind a socket (only server)	SocketBind - Bind a socket to my IP-address and port on page 738
Listening connections (only server)	SocketListen - Listen for incoming connections on page 747
Accept connections (only server)	SocketAccept - Accept an incoming connection on page 735
Get current socket state	SocketGetStatus - Get current socket state on page 1462
Example client socket application	SocketSend - Send data to remote computer on page 759
Send data to remote computer	SocketSendTo - Send data to remote computer on page 763
Test for the presence of data on a socket.	SocketPeek - Test for the presence of data on a socket on page 1465

1.262 SocketSend - Send data to remote computer

Usage

SocketSend is used to send data to a remote computer. SocketSend can be used both for client and server applications.

Basic examples

The following example illustrates the instruction SocketSend:

See also [More examples on page 760](#).

Example 1

```
SocketSend socket1 \Str := "Hello world";
```

Sends the message "Hello world" to the remote computer.

Arguments

```
SocketSend Socket [ \Str ] | [ \RawData ] | [ \Data ] [ \NoOfBytes ]
```

Socket

Data type: socketdev

In client application the socket to send from must already be created and connected.

In server application the socket to send to must already be accepted.

[\Str]

Data type: string

The string to send to the remote computer.

[\RawData]

Data type: rawbytes

The rawbytes data to send to the remote computer.

[\Data]

Data type: array of byte

The data in the byte array to send to the remote computer.

Only one of the optional parameters \Str, \RawData, or \Data can be used at the same time.

[\NoOfBytes]

Data type: num

If this argument is specified only this number of bytes will be sent to the remote computer. The call to SocketSend will fail if \NoOfBytes is larger than the actual number of bytes in the data structure to send.

If this argument is not specified then the whole data structure (valid part of rawbytes) will be sent to the remote computer.

Continues on next page

1 Instructions

1.262 SocketSend - Send data to remote computer

Socket Messaging

Continued

Program execution

The specified data is sent to the remote computer. If the connection is broken an error is generated.

The data that is transferred on the cable is always bytes, max. 1024 bytes in one message. No header is added by default to the message. The usage of any header is reserved for the actual application.

Parameter	Input data	Cable data	Output data
\Str	1 char	1 byte (8 bits)	1 char
\RawData	1 rawbytes	1 byte (8 bits)	1 rawbytes
\Data	1 byte	1 byte (8 bits)	1 byte

It's possible to mix the used data type (string, rawbytes, or array of byte) between SocketSend and SocketReceive.

Error handling

The following recoverable errors are generated and can be handled in an error handler. The system variable `ERRNO` will be set to:

Name	Cause of error
ERR_SOCKET_CLOSED	The socket is closed. Broken connection.
ERR_SOCKET_NET_UNREACH	Network is unreachable or connection is lost after a socket is opened.
ERR_SOCKET_NOT_CONN	The socket is not connected
ERR_SOCKET_UNSPEC	Unspecified exception from underlying call to the operating system.

More examples

More examples of the instruction `SocketSend` are illustrated below.

Example 1

```
VAR socketdev client_socket;
VAR string receive_string;

PROC client_messaging()
...
! Create and connect the socket in error handlers
SocketSend client_socket \Str := "Hello server";
SocketReceive client_socket \Str := receive_string;
...
SocketClose client_socket;
ERROR
IF ERRNO=ERR_SOCKET_TIMEOUT THEN
RETRY;
ELSEIF ERRNO=ERR_SOCKET_CLOSED THEN
client_recover;
RETRY;
ELSE
! No error recovery handling
```

Continues on next page

```
ENDIF
ENDPROC

PROC client_recover()
  SocketClose client_socket;
  SocketCreate client_socket;
  SocketConnect client_socket, "192.168.0.2", 1025;
ERROR
  IF ERRNO=ERR_SOCK_TIMEOUT THEN
    RETRY;
  ELSEIF ERRNO=ERR_SOCK_CLOSED THEN
    RETURN;
  ELSE
    ! No error recovery handling
  ENDIF
ENDPROC
```

This is an example of a client program with creation and connection of socket in error handlers. In this way the program can handle power fail restart.

In the procedure `client_recover` the client socket is created and connected to a remote computer server with IP-address 192.168.0.2 on port 1025.

In the communication procedure `client_messaging` the client sends "Hello server" to the server and the server responds with "Hello client" to the client, which is stored in the variable `receive_string`.

Example 2

```
VAR socketdev client_socket;
VAR string receive_string;

PROC client_messaging()
  ...
  ! Send cr and lf to the server
  SocketSend client_socket \Str := "\0D\0A";
  ...
ENDPROC
```

This is an example of a client program that sends non printable characters (binary data) in a string. This can be useful if communicating with sensors or other clients that requires such characters.

Limitations

There is no built-in synchronization mechanism in *Socket Messaging* to prevent received messages that are compounded of several sent messages. It is up to the programmer to handle the synchronization with *Ack* messages (one sequence of `SocketSend` - `SocketReceive` in the client or server program must be completed before the next sequence of `SocketSend` - `SocketReceive`).

All sockets are closed after power fail restart. This problem can be handled by error recovery. See example above.

Continues on next page

1 Instructions

1.262 SocketSend - Send data to remote computer

Socket Messaging

Continued

Avoid fast loops with `SocketCreate ... SocketClose` because the socket is not really closed until a certain time (TCP/IP functionality).

The size of the data to send is limited to 1024 bytes.

Syntax

```
SocketSend
  [Socket ':='] <variable (VAR) of socketdev>
  [\Str ':='] <expression (IN) of string>]
  |[\RawData ':='] <variable (VAR) of rawdata>]
  |[\Data ':='] <array {*} (IN) of byte>]
  ['\' NoOfBytes ':='] <expression (IN) of num>]';'
```

Related information

For information about	See
Socket communication in general	Application manual - Controller software IRC5
Create a new socket	SocketCreate - Create a new socket on page 745
Connect to remote computer (only client)	SocketConnect - Connect to a remote computer on page 742
Receive data from remote computer	SocketReceive - Receive data from remote computer on page 749
Close the socket	SocketClose - Close a socket on page 740
Bind a socket (only server)	SocketBind - Bind a socket to my IP-address and port on page 738
Listening connections (only server)	SocketListen - Listen for incoming connections on page 747
Accept connections (only server)	SocketAccept - Accept an incoming connection on page 735
Get current socket state	SocketGetStatus - Get current socket state on page 1462
Example server socket application	SocketReceive - Receive data from remote computer on page 749
Use of non printable characters (binary data) in string literals.	Technical reference manual - RAPID kernel

1.263 SocketSendTo - Send data to remote computer

Usage

`SocketSendTo` is used to send data to a remote computer. `SocketSendTo` can be used both for client and server applications.

`SocketSendTo` is used for connectionless communication with datagram protocol UDP/IP.

Basic examples

The following example illustrates the instruction `SocketSendTo`:

See also [More examples on page 760](#).

Example 1

```
VAR socketdev udp_socket;

SocketCreate udp_socket \UDP;
SocketSendTo udp_socket, Address, Port \Str := "Hello world";
```

Sends the message "Hello world" to the remote computer with IP address Address and port Port.

Arguments

```
SocketSendTo Socket RemoteAddress RemotePort [ \Str ] | [ \RawData
] | [ \Data ] [ \NoOfBytes ]
```

Socket

Data type: `socketdev`

The socket must already been created.

RemoteAddress

Data type: `string`

The address of the remote computer. The remote computer must be specified as an IP address. It is not possible to use the name of the remote computer.

RemotePort

Data type: `num`

The port on the remote computer. Generally ports 1025-4999 are free to use. Ports below 1025 can already be taken.

[\Str]

Data type: `string`

The string to send to the remote computer.

[\RawData]

Data type: `rawbytes`

The rawbytes data to send to the remote computer.

[\Data]

Data type: array of byte

Continues on next page

1 Instructions

1.263 SocketSendTo - Send data to remote computer

Socket Messaging

Continued

The data in the `byte` array to send to the remote computer.

Only one of the optional parameters `\Str`, `\RawData`, or `\Data` can be used at the same time.

[`\NoOfBytes`]

Data type: `num`

If this argument is specified only this number of bytes will be sent to the remote computer. The call to `SocketSendTo` will fail if `\NoOfBytes` is larger than the actual number of bytes in the data structure to send.

If this argument is not specified then the whole data structure (valid part of `rawbytes`) will be sent to the remote computer.

Program execution

The specified data is sent to the remote computer.

The data that is transferred on the cable is always bytes, max. 1024 bytes in one message. No header is added by default to the message. The usage of any header is reserved for the actual application.

Parameter	Input data	Cable data	Output data
<code>\Str</code>	1 char	1 byte (8 bits)	1 char
<code>\RawData</code>	1 rawbytes	1 byte (8 bits)	1 rawbytes
<code>\Data</code>	1 byte	1 byte (8 bits)	1 byte

It's possible to mix the used data type (string, rawbytes, or array of byte) between `SocketSendTo` and `SocketReceiveFrom`.

Error handling

The following recoverable errors are generated and can be handled in an error handler. The system variable `ERRNO` will be set to:

Name	Cause of error
<code>ERR_SOCKET_CLOSED</code>	The socket is closed.
<code>ERR_SOCKET_NET_UNREACH</code>	Network is unreachable or connection is lost after a socket is opened.

More examples

More examples of the instruction `SocketSendTo` are illustrated below.

Example 1

```
VAR socketdev client_socket;
VAR string receive_string;
VAR string RemoteAddress;
VAR num RemotePort;

PROC client_messaging()
...
! Create and bind the socket in error handlers
SocketSendTo client_socket, "192.168.0.2", 1025 \Str := "Hello
server";
```

Continues on next page

1.263 SocketSendTo - Send data to remote computer

*Socket Messaging**Continued*

```

SocketReceiveFrom client_socket \Str := receive_string,
    RemoteAddress, RemotePort;
...
SocketClose client_socket;
ERROR
IF ERRNO=ERR_SOCK_TIMEOUT THEN
    RETRY;
ELSEIF ERRNO=ERR_SOCK_CLOSED THEN
    client_recover;
    RETRY;
ELSE
    ! No error recovery handling
ENDIF
ENDPROC

PROC client_recover()
SocketClose client_socket;
SocketCreate client_socket \UDP;
SocketBind client_socket, "192.168.0.2", 1025;
ERROR
IF ERRNO=ERR_SOCK_TIMEOUT THEN
    RETRY;
ELSEIF ERRNO=ERR_SOCK_CLOSED THEN
    RETURN;
ELSE
    ! No error recovery handling
ENDIF
ENDPROC

```

This is an example of a client program with creation and bind of socket in error handlers. In this way the program can handle power fail restart.

In the procedure `client_recover` the client socket is created and bound to a remote computer server with IP-address 192.168.0.2 on port 1025.

In the communication procedure `client_messaging` the client sends "Hello server" to the server and the server responds with "Hello client" to the client, which is stored in the variable `receive_string`.

Example 2

```

VAR socketdev udp_socket;

PROC message_send()
...
! Send cr and lf to the server
SocketSendTo udp_socket, "192.168.0.2", 1025 \Str := "\0D\0A";
...
ENDPROC

```

This is an example the program sends non printable characters (binary data) in a string. This can be useful if communicating with sensors or other clients that requires such characters.

Continues on next page

1 Instructions

1.263 SocketSendTo - Send data to remote computer

Socket Messaging

Continued

Limitations

All sockets are closed after power fail restart. This problem can be handled by error recovery. See example above.

The size of the data to send is limited to 1024 bytes.

Syntax

```
SocketSendTo
[Socket ':='] <variable (VAR) of socketdev>
[RemoteAddress ':='] <expression (IN) of string>
[RemotePort ':='] <expression (IN) of num>
[\\Str ':=' <expression (IN) of string>]
|[\\RawData ':=' <variable (VAR) of rawdata>]
|[\\Data ':=' <array {*} (IN) of byte>]
['\\' NoOfBytes ':=' <expression (IN) of num>]';'
```

Related information

For information about	See
Socket communication in general	Application manual - Controller software IRC5
Create a new socket	SocketCreate - Create a new socket on page 745
Connect to remote computer (only client)	SocketConnect - Connect to a remote computer on page 742
Receive data from remote computer	SocketReceive - Receive data from remote computer on page 749
Close the socket	SocketClose - Close a socket on page 740
Bind a socket (only server)	SocketBind - Bind a socket to my IP-address and port on page 738
Listening connections (only server)	SocketListen - Listen for incoming connections on page 747
Accept connections (only server)	SocketAccept - Accept an incoming connection on page 735
Get current socket state	SocketGetStatus - Get current socket state on page 1462
Example server socket application	SocketReceive - Receive data from remote computer on page 749
Receive data from remote computer	SocketReceiveFrom - Receive data from remote computer on page 754
Use of non printable characters (binary data) in string literals.	Technical reference manual - RAPID kernel

1.264 SoftAct - Activating the soft servo

Usage

SoftAct (*Soft Servo Activate*) is used to activate the so called “soft” servo on any axis of the robot or external mechanical unit.

This instruction can only be used in the main task T_ROB1 or, if in a *MultiMove* system, in any motion tasks.

Basic examples

The following example illustrates the instruction SoftAct:

Example 1

```
SoftAct 3, 20;
```

Activation of soft servo on robot axis 3 with softness value 20%.

Example 2

```
SoftAct 1, 90 \Ramp:=150;
```

Activation of the soft servo on robot axis 1 with softness value 90% and ramp factor 150%.

Example 3

```
SoftAct \MechUnit:=orbit1, 1, 40 \Ramp:=120;
```

Activation of soft servo on axis 1 for the mechanical unit orbit1 with softness value 40% and ramp factor 120%.

Arguments

```
SoftAct [\MechUnit] Axis Softness [\Ramp]
```

[\MechUnit]

Mechanical Unit

Data type: mecunit

The name of the mechanical unit. If this argument is omitted then it means activation of the soft servo for specified robot axis in the current program task.

Axis

Data type: num

Number of the robot or external axis to work with soft servo.

Softness

Data type: num

Softness value in percent (0 - 100%). 0% denotes min. softness (max. stiffness), and 100% denotes max. softness.

[\Ramp]

Data type: num

Ramp factor in percent ($\geq 100\%$). The ramp factor is used to control the engagement of the soft servo. A factor 100% denotes the normal value; with greater

Continues on next page

1 Instructions

1.264 SoftAct - Activating the soft servo

RobotWare Base

Continued

values the soft servo is engaged more slowly (longer ramp). The default value for ramp factor is 100 %.

Program execution

Softness is activated at the value specified for the current axis. The softness value is valid for all movement until a new softness value is programmed for the current axis or until the soft servo is deactivated by the instruction `SoftDeact`.

Limitations

Soft servo for any robot or external axis is always deactivated when there is a power failure. This limitation can be handled in the user program when restarting after a power failure.

The same axis must not be activated twice unless there is a moving instruction in between. Thus, the following program sequence should be avoided. Otherwise there will be a jerk in the robot movement:

```
SoftAct n , x ;  
SoftAct n , y ;
```

(n = robot axis n, x, and y softness values)



WARNING

The braking distance for category 1 stops will be longer when soft servo is active.

Syntax

```
SoftAct  
[ '\MechUnit' := < variable (VAR) of mecunit> ',' ]  
[ Axis := ] < expression (IN) of num> ','  
[ Softness := ] < expression (IN) of num> ','  
[ '\Ramp' := < expression (IN) of num> ] ;
```

Related information

For information about	See
Deactivate soft servo	SoftDeact - Deactivating the soft servo on page 769
Behavior with the soft servo engaged	<i>Technical reference manual - RAPID Overview</i>
Configuration of external axes	<i>Application manual - Additional axes and standalone controller</i>

1.265 SoftDeact - Deactivating the soft servo

Usage

SoftDeact (*Soft Servo Deactivate*) is used to deactivate the so called “soft” servo.

Basic examples

The following examples illustrate the instruction SoftDeact:

Example 1

```
SoftDeact;
```

Deactivating the soft servo on all axes.

Example 2

```
SoftDeact \Ramp:=150;
```

Deactivating the soft servo on all axes, with ramp factor 150 %.

Arguments

```
SoftDeact [\Ramp]
```

[\Ramp]

Data type: num

Ramp factor in percent (≥ 100 %). The ramp factor is used to control the deactivating of the soft servo. A factor 100% denotes the normal value. With greater values the soft servo is deactivated more slowly (longer ramp). The default value for ramp factor is 100 %.

Program execution

The soft servo is deactivated for the mechanical units that are controlled from current program task. If SoftDeact is done from a non-motion task, the soft servo is deactivated for the mechanical unit controlled by the connected motion task. Executing a SoftDeact when in synchronized movement mode, soft servo will be deactivated for all mechanical units that are synchronized.

When deactivating soft servo with SoftDeact the robot will move to the programmed position even if the robot has moved out of position during soft servo activation.

Syntax

```
SoftDeact  
[ '\Ramp :=' < expression (IN) of num > ]';'
```

Related information

For information about	See
Activating the soft servo	SoftAct - Activating the soft servo on page 767

1 Instructions

1.266 SoftElbow - Making the elbow flexible for external forces *Seven axis robot*

1.266 SoftElbow - Making the elbow flexible for external forces

Usage

`SoftElbow` is used to activate or deactivate soft elbow on a 7-axes robot. When active, the elbow can be pushed so the elbow position is changed without affecting the TCP. The TCP will continue to move along its programmed path.

Basic example

The following examples illustrate the instruction `SoftElbow`:

Example 1

```
SoftElbow \On;
```

After executing this instruction, the robot elbow can be moved without affecting the TCP.

Arguments

```
SoftElbow [\On] | [\Off]
```

`[\On]`

Data type: switch

Activates soft elbow.

`[\Off]`

Data type: switch

Deactivates soft elbow.

Program execution

Once soft elbow is turned on, the elbow will remain soft until it is turned off with a new `SoftElbow` instruction.

As long as soft elbow is active, the elbow will bend away from any obstacle or anything pushing the elbow. If the robot is moving, the TCP will continue following its path and the program execution will not be interrupted in any way.

The default value (deactivated soft elbow) is automatically set:

- when using the restart mode Reset RAPID
 - when loading a new program or a new module
 - when starting program execution from the beginning
 - when moving the program pointer to main
 - when moving the program pointer to a routine
 - when moving the program pointer in such a way that the execution order is lost.
-

Limitations

- `SoftElbow` is only available for 7-axes robots (e.g. YuMi).
 - `SoftElbow` will not work when the tool is in contact with a fixed object and a non-negligible force is applied (for example when pressing an object into a fixture).
-

Continues on next page

1.266 SoftElbow - Making the elbow flexible for external forces

Seven axis robot

Continued

- While the arm is being pushed, it may lead to somewhat decreased path accuracy.
- `SoftElbow` is not compatible with other compliant modes (for example `Lead Through`, `Force control` or `SoftMove`).
- `SoftElbow` is not compatible with `MultiMove Coordinated`.
- `SoftElbow` only works well with moderate speeds, typically lower than 1000mm/s.
- Absolute accuracy will be temporarily deactivated while soft elbow is active.

Syntax

```
SoftElbow  
  ['\ ' On] | ['\ ' Off]';'
```

1 Instructions

1.267 SpeedLimAxis - Set speed limitation for an axis

RobotWare Base

1.267 SpeedLimAxis - Set speed limitation for an axis

Usage

`SpeedLimAxis` is used to set a speed limit value for an axis. The speed reduction is done when the system input signal `LimitSpeed` is set to 1. With this instruction it is possible to setup a speed limitation that later on should be applied.

This instruction can only be used in the main task `T_ROB1` or, if in a *MultiMove* system, in any Motion tasks.

Basic examples

The following examples illustrate the instruction `SpeedLimAxis`:

Example 1

```
SpeedLimAxis STN_1, 1, 20;
```

This will limit the speed to 20 degrees/second on axis 1 for mechanical unit `STN_1` when system input `LimitSpeed` is set to 1.

Example 2

```
SpeedLimAxis ROB_1, 1, 10;  
SpeedLimAxis ROB_1, 2, 30;  
SpeedLimAxis ROB_1, 3, 30;  
SpeedLimAxis ROB_1, 4, 30;  
SpeedLimAxis ROB_1, 5, 30;  
SpeedLimAxis ROB_1, 6, 30;
```

This will limit the speed to 30 degrees/second on axis 2 to 6, and limit the speed to 10 degrees/second on axis 1 for mechanical unit `ROB_1` when system input `LimitSpeed` is set to 1.

Arguments

```
SpeedLimAxis MechUnit AxisNo AxisSpeed
```

MechUnit

Mechanical Unit

Data type: `mecunit`

The name of the mechanical unit.

AxisNo

Data type: `num`

The number of the current axis for the mechanical unit.

AxisSpeed

Data type: `num`

The speed that should be applied. For a rotating axis the speed should be in degrees/second and for a linear axis it should be in mm/s.

Continues on next page

Program execution

`SpeedLimAxis` is used to set a speed limit value for an axis for a specific mechanical unit. The speed reduction is not done at once. The values are stored and are applied when the system input signal `LimitSpeed` is set to 1.

If `SpeedLimAxis` is not used to set a limitation for an axis, then the speed limitation for manual mode will be used instead. If no limitation at all is wanted for a specific axis, a high value should be entered. Furthermore, if no limitation of the checkpoint speed is set using the instruction `SpeedLimCheckPoint`, then the speed limitations for manual mode will be used to limit the checkpoint speed.

When the system input signal `LimitSpeed` is set to 1, the speed is ramped down to the reduced speed.

When the system input signal `LimitSpeed` is set to 0, the speed is ramped up to the programmed speed used in the current movement instruction.

The maximum allowed acceleration during ramping up is controlled by the system parameter *Limit Speed Acc Limitation* in the type *Motion Planner*.

The system output signal `LimitSpeed` is set to 1, when the reduced speed is reached. The system output signal `LimitSpeed` is set to 0, when the speed starts to ramp up.

The default values for speed limitation are automatically set

- when using the restart mode **Reset RAPID**
- when loading a new program or a new module
- when starting program execution from the beginning
- when moving the program pointer to `main`
- when moving the program pointer to a routine
- when moving the program pointer in such a way that the execution order is lost.

Error handling

The following recoverable errors are generated and can be handled in an error handler. The system variable `ERRNO` will be set to:

Name	Cause of error
<code>ERR_AXIS_PAR</code>	Parameter axis in instruction is wrong
<code>ERR_SPEEDLIM_VALUE</code>	The speed used in argument <code>AxisSpeed</code> is too low.

More examples

More examples of the instruction `SpeedLimAxis` are illustrated below.

Example 1

```

..
VAR intnum sigint1;
VAR intnum sigint2;
..
PROC main()
  ! Setup interrupts reacting on a signal input
  IDelete sigint1;

```

Continues on next page

1 Instructions

1.267 SpeedLimAxis - Set speed limitation for an axis

RobotWare Base

Continued

```
CONNECT sigint1 WITH setlimitspeed;
ISignalDI \SingleSafe, mysensorsignal, 1, sigint1;
IDelete sigint2;
CONNECT sigint2 WITH resetlimitspeed;
ISignalDI \SingleSafe, mysensorsignal, 0, sigint2;
..
MoveL p1, z50, fine, tool2;
MoveL p2, z50, fine, tool2;
..
MoveL p10, v100, fine, tool2;
! Set limitations for checkpoints and axes
SpeedLimCheckPoint 200;
SpeedLimAxis ROB_1, 1, 10;
SpeedLimAxis ROB_1, 2, 10;
SpeedLimAxis ROB_1, 3, 10;
SpeedLimAxis ROB_1, 4, 20;
SpeedLimAxis ROB_1, 5, 20;
SpeedLimAxis ROB_1, 6, 20;
WHILE run_loop = TRUE DO
  MoveL p1, vmax, z50, tool2;
  ..
  MoveL p99, vmax, fine, tool2;
ENDWHILE
! Set the default manual mode max speed
SpeedLimCheckPoint 0;
SpeedLimAxis ROB_1, 1, 0;
SpeedLimAxis ROB_1, 2, 0;
SpeedLimAxis ROB_1, 3, 0;
SpeedLimAxis ROB_1, 4, 0;
SpeedLimAxis ROB_1, 5, 0;
SpeedLimAxis ROB_1, 6, 0;
..
TRAP setlimitspeed
IDelete sigint1;
CONNECT sigint1 WITH setlimitspeed;
ISignalDI \SingleSafe, mysensorsignal, 1, sigint1;
! Set out signal that is cross connected to system input
  LimitSpeed
SetDO dolLimitSpeed, 1;
ENDTRAP
TRAP resetlimitspeed
IDelete sigint2;
CONNECT sigint2 WITH resetlimitspeed;
ISignalDI \SingleSafe, mysensorsignal, 0, sigint2;
! Reset out signal that is cross connected to system input
  LimitSpeed
SetDO dolLimitSpeed, 0;
ENDTRAP
```

During the robot movement from position p1 to p10, the default speed limitation is used (manual mode speed). A new speed limit for the checkpoints for the TCP

Continues on next page

robot and for the axes are added. The trap routine `setlimitspeed` will apply the speed limitation if signal `mysensorsignal` changes value to 1.

The trap routine `resetlimitspeed` will remove the speed limitation when signal `mysensorsignal` changes value to 0.

The new settings for the speed limitation will be used as long as the variable `run_loop` is `TRUE` and the system input signal `LimitSpeed` is set to 1. When `run_loop` is set to `FALSE` the default speed limitation (manual mode speed) is set.



Note

The trap routine in the example is only used to visualize the functionality. The signal used to limit the speed could also be connected either directly to the system input signal `LimitSpeed`, or through a safety PLC.

Limitations

`SpeedLimAxis` cannot be used in the POWER ON event routine.

When reducing the speed of one axis or checkpoint, the other axes will also be reduced to the same percentage to be able to run along the programmed path. The process speed along the programmed path will vary.

When using `SafeMove` together with speed limitation, `SafeMove` must be setup with a margin since the `SafeMove` and motion calculations are slightly different.

Syntax

```
SpeedLimAxis
  [MechUnit ':='] <variable (VAR) of mecunit>','
  [AxisNo ':='] <expression (IN) of num>','
  [AxisSpeed ':='] <expression (IN) of num>;'
```

Related information

For information about	See
Positioning instructions	<i>Technical reference manual - RAPID Overview</i>
Set speed limitation for check points	SpeedLimCheckPoint - Set speed limitation for check points on page 776
System input and output signals	<i>Technical reference manual - System parameters</i>

1 Instructions

1.268 SpeedLimCheckPoint - Set speed limitation for check points

RobotWare Base

1.268 SpeedLimCheckPoint - Set speed limitation for check points

Usage

`SpeedLimCheckPoint` is used to set a speed limit value for a TCP robot. The speed reduction is done when the system input signal `LimitSpeed` is set to 1. With this instruction it is possible to setup a speed limit that later on should be applied.

The reduction of the speed is done if any of the checkpoints are running faster than the limit set by `SpeedLimCheckPoint`. (For More information about checkpoints, see [More examples on page 778](#).)

This instruction can only be used in the main task `T_ROB1` or, if in a *MultiMove* system, in any Motion tasks.

Basic examples

The following example illustrates the instruction `SpeedLimCheckPoint`:

Example 1

```
VAR num limit_speed:=200;  
SpeedLimCheckPoint limit_speed;
```

This will limit the speed to 200 mm/s for the TCP robot when system input `LimitSpeed` is set to 1.

Arguments

`SpeedLimCheckPoint` RobSpeed

RobSpeed

Data type: num

The speed limitation in mm/s that should be applied.

Continues on next page

Program execution

Definition of checkpoints, see figure below.

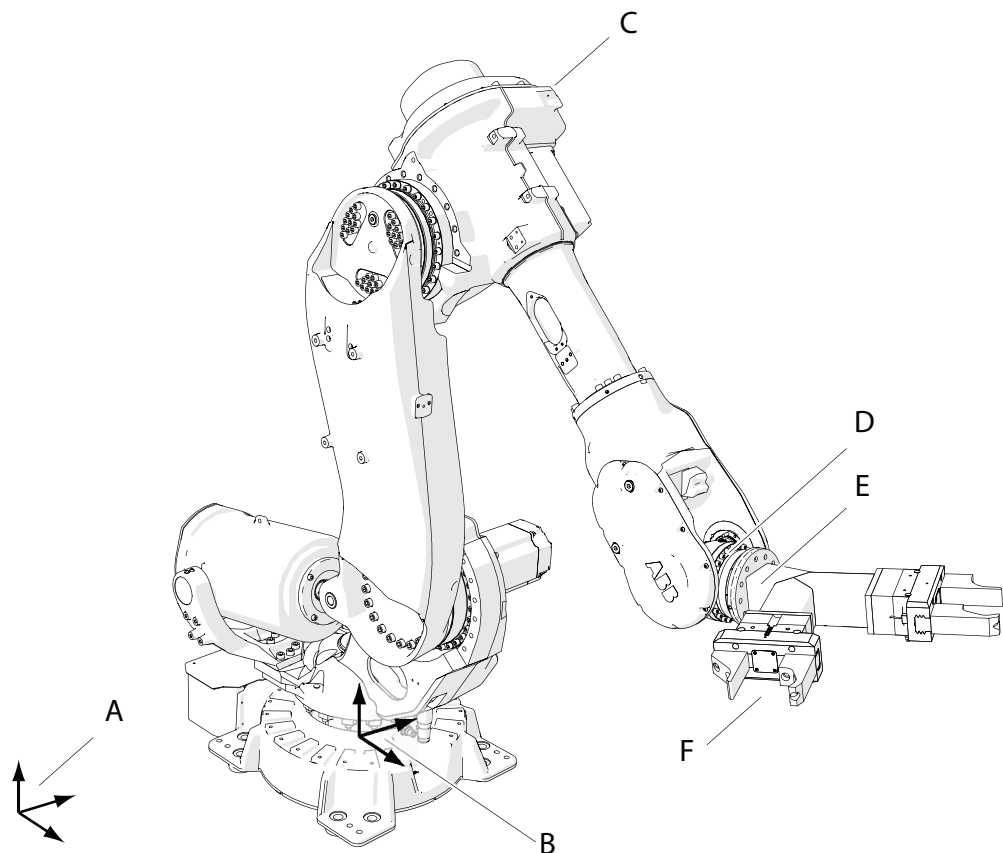

xx120000521

A	World coordinate system
B	Base coordinate system
C	Arm checkpoint
D	Wrist Center Point (WCP)
E	tool0
F	Tool Center Point (TCP)

`SpeedLimCheckPoint` is used to set a speed limit value for 4 checkpoints for a TCP robot. The checkpoints that will be limited are the arm, the wrist, tool0, and the active TCP, as seen in the picture above. The speed reduction is not done at once. The values are stored and are applied when the system input signal `LimitSpeed` is set to 1. The speed of the checkpoints are limited relative to the base coordinate system.

If instruction `SpeedLimCheckPoint` is not used to set a limitation, the speed limitation for manual mode will be used as limitation. If no limitation at all is wanted for the checkpoints, a high value should be entered. Furthermore, if no limitation of the axis speeds are set using the instruction `SpeedLimAxis`, then the speed limitations for manual mode will be used to limit the axis speed.

Continues on next page

1 Instructions

1.268 SpeedLimCheckPoint - Set speed limitation for check points

RobotWare Base

Continued

When the system input signal `LimitSpeed` is set to 1, the speed is ramped down to the reduced speed.

When the system input signal `LimitSpeed` is set to 0, the speed is ramped up to the programmed speed used in the current movement instruction.

The maximum allowed acceleration during ramping up is controlled by the system parameter *Limit Speed Acc Limitation* in the type *Motion Planner*.

The system output signal `LimitSpeed` is set to 1, when the reduced speed is reached. The system output signal `LimitSpeed` is set to 0, when the speed starts to ramp up.

The default values for speed limitation are automatically set

- when using the restart mode **Reset RAPID**
- when loading a new program or a new module
- when starting program execution from the beginning
- when moving the program pointer to `main`
- when moving the program pointer to a routine
- when moving the program pointer in such a way that the execution order is lost.

Error handling

The following recoverable errors are generated and can be handled in an error handler. The system variable `ERRNO` will be set to:

Name	Cause of error
<code>ERR_SPEEDLIM_VALUE</code>	The speed used in argument <code>RobSpeed</code> is too low.

More examples

More examples of the instruction `SpeedLimCheckPoint` are illustrated below.

Example 1

```
..
VAR intnum sigint1;
VAR intnum sigint2;
..
PROC main()
  ! Setup interrupts reacting on a signal input
  IDelete sigint1;
  CONNECT sigint1 WITH setlimitspeed;
  ISignalDI \SingleSafe, mysensorsignal, 1, sigint1;
  IDelete sigint2;
  CONNECT sigint2 WITH resetlimitspeed;
  ISignalDI \SingleSafe, mysensorsignal, 0, sigint2;
  ..
  MoveL p1, z50, fine, tool2;
  MoveL p2, z50, fine, tool2;
  ..
  MoveL p10, v100, fine, tool2;
  ! Set limitations for checkpoints and axes
```

Continues on next page

1.268 SpeedLimCheckPoint - Set speed limitation for check points

RobotWare Base

Continued

```

SpeedLimCheckPoint 200;
SpeedLimAxis ROB_1, 1, 10;
SpeedLimAxis ROB_1, 2, 10;
SpeedLimAxis ROB_1, 3, 10;
SpeedLimAxis ROB_1, 4, 20;
SpeedLimAxis ROB_1, 5, 20;
SpeedLimAxis ROB_1, 6, 20;
WHILE run_loop = TRUE DO
  MoveL p1, vmax, z50, tool2;
  ..
  MoveL p99, vmax, fine, tool2;
ENDWHILE
! Set the default manual mode max speed
SpeedLimCheckPoint 0;
SpeedLimAxis ROB_1, 1, 0;
SpeedLimAxis ROB_1, 2, 0;
SpeedLimAxis ROB_1, 3, 0;
SpeedLimAxis ROB_1, 4, 0;
SpeedLimAxis ROB_1, 5, 0;
SpeedLimAxis ROB_1, 6, 0;
..
TRAP setlimitspeed
  IDelete sigint1;
  CONNECT sigint1 WITH setlimitspeed;
  ISignalDI \SingleSafe, mysensorsignal, 1, sigint1;
  ! Set out signal that is cross connected to system input
    LimitSpeed
  SetDO dolLimitSpeed, 1;
ENDTRAP
TRAP resetlimitspeed
  IDelete sigint2;
  CONNECT sigint2 WITH resetlimitspeed;
  ISignalDI \SingleSafe, mysensorsignal, 0, sigint2;
  ! Reset out signal that is cross connected to system input
    LimitSpeed
  SetDO dolLimitSpeed, 0;
ENDTRAP

```

During the robot movement from position p1 to p10, the default speed limitation is used (manual mode speed). A new speed limit for the checkpoints for the TCP robot and for the axes are added. The trap routine `setlimitspeed` will apply the speed limitation if signal `mysensorsignal` changes value to 1.

The trap routine `resetlimitspeed` will remove the speed limitation when signal `mysensorsignal` changes value to 0.

The new settings for the speed limitation will be used as long as the variable `run_loop` is TRUE and the system input signal `LimitSpeed` is set to 1. When

Continues on next page

1 Instructions

1.268 SpeedLimCheckPoint - Set speed limitation for check points

RobotWare Base

Continued

`run_loop` is set to `FALSE` the default speed limitation (manual mode speed) is set.



Note

The trap routine in the example is only used to visualize the functionality. The signal used to limit the speed could also be connected either directly to the system input signal `LimitSpeed`, or through a safety PLC.

Limitations

`SpeedLimCheckPoint` cannot be used in the POWER ON event routine.

If a robot is standing on a moving track, then the checkpoint speed in the world frame can be higher than the specified checkpoint speed limit in the base frame. The checkpoint speed in the world frame can be the sum of the track speed and the checkpoint speed in the base frame. To also limit the checkpoint speed in the world frame, make sure that the sum of both does not exceed the limit.

When reducing the speed of one axis or checkpoint, the other axes will also be reduced to the same percentage to be able to run along the programmed path. The process speed along the programmed path will vary.

When using SafeMove together with speed limitation, SafeMove must be setup with a margin and tested, since the SafeMove and motion calculations are slightly different. A change of tool TCP on the fly is not synchronized with SafeMove. So the tool TCP in SafeMove must either be shorter than the tools used by the robot, or the max checkpoint speed for SafeMove must be setup with an extra margin and tested.

Syntax

```
SpeedLimCheckPoint  
  [RobSpeed ':='] <expression (IN) of num>';'
```

Related information

For information about	See
Positioning instructions	<i>Technical reference manual - RAPID Overview</i>
Set speed limitation for an axis	SpeedLimAxis - Set speed limitation for an axis on page 772
Defining arm loads	<i>Technical reference manual - System parameters</i>
System input and output signals	<i>Technical reference manual - System parameters</i>

1.269 SpeedRefresh - Update speed override for ongoing movement

Usage

`SpeedRefresh` is used to change the movement speed for the ongoing robot movement in current motion program task. With this instruction it is possible to create some type of coarse speed adaptation from some sensor input.

This instruction can only be used in the main task `T_ROB1` or, if in a *MultiMove* system, in any Motion tasks.

Basic examples

The following example illustrates the instruction `SpeedRefresh`:

Example 1

```
VAR num change_speed:=70;
SpeedRefresh change_speed;
```

This will change the current speed override to 70%.

Arguments

`SpeedRefresh` Override

Override

Data type: num

The speed override value within range 0 ... 100 %.

Program execution

The actual speed override value for the ongoing movements of robot and external units in current motion program task will be updated.

All speed data components for any mechanical units in current motion task will be influenced.



Note

Speed override set from `SpeedRefresh` is not equal to setting the speed from the FlexPendant. These are two different values. The product of these two values and the programmed speed will be the speed that is used in the movement.

If a PP to main is done or if a new program is loaded, the speed that was set with `SpeedRefresh` will be reset, and the speed set from the FlexPendant will be applied.

Error handling

The following recoverable errors are generated and can be handled in an error handler. The system variable `ERRNO` will be set to:

Name	Cause of error
<code>ERR_SPEED_REFRESH_LIM</code>	Override has a value outside the range of 0 to 100 %.

Continues on next page

1 Instructions

1.269 SpeedRefresh - Update speed override for ongoing movement

RobotWare Base

Continued

More examples

More examples of the instruction `SpeedRefresh` are illustrated below.

Example 1

```
VAR intnum time_int;
VAR num override;
...
PROC main()
  CONNECT time_int WITH speed_refresh;
  ITimer 0.1, time_int;
  ISleep time_int;
  ...
  MoveL p1, v100, fine, tool2;
  ! Read current speed override set from FlexPendant
  override := CSpeedOverride (\CTask);
  IWatch time_int;
  MoveL p2, v100, fine, tool2;
  IDelete time_int;
  ! Reset to FlexPendant old speed override
  WaitTime 0.5;
  SpeedRefresh override;
  ...
TRAP speed_refresh
  VAR speed_corr;
  ! Analog input signal value from sensor, value 0 ... 10
  speed_corr := (ai_sensor * 10);
  SpeedRefresh speed_corr;
  ERROR
    IF ERRNO = ERR_SPEED_REFRESH_LIM THEN
      IF speed_corr > 100 speed_corr := 100;
      IF speed_corr < 0 speed_corr := 0;
      RETRY;
    ENDIF
  ENDTRAP
```

During the robot movement from position `p1` to `p2`, the speed override value is updated every 0.1 s in the trap routine `speed_refresh`. The analog input signal `ai_sensor` is used for calculation of Override value for the instruction `SpeedRefresh`. There is no trap routine execution before or after the robot movement between `p1` and `p2`. The manual speed override from FlexPendant is restored. After that the robot has to reach `p2`.

Limitations

Note that with `SpeedRefresh` the speed override will not be done momentary. Instead there will be a lag of 0.3 - 0.5 seconds between the order and the influence on the physical robot.

The user is responsible to reset the speed override value from the RAPID program after the `SpeedRefresh` sequence.

If `SpeedRefresh` is used in the `START` or in the `RESET` event routine, the speed that is set is always the actual FlexPendant speed override.

Continues on next page

1.269 SpeedRefresh - Update speed override for ongoing movement

RobotWare Base

Continued

Syntax

SpeedRefresh

[Override ':= '] < expression (IN) of num > ';'

Related information

For information about	See
Positioning instructions	<i>Technical reference manual - RAPID Overview</i>
Definition of velocity	speeddata - Speed data on page 1751
Read current speed override	CSpeedOverride - Reads the current override speed on page 1235

1 Instructions

1.270 SpyStart - Start recording of execution time data *RobotWare Base*

1.270 SpyStart - Start recording of execution time data

Usage

`SpyStart` is used to start the recording of instruction and time data during execution.

The execution data will be stored in a file for later analysis.

The stored data is intended for debugging RAPID programs, specifically for multi-tasking systems (only necessary to have `SpyStart` - `SpyStop` in one program task).

Basic examples

The following example illustrates the instruction `SpyStart`:

Example 1

```
SpyStart "HOME:/spy.log";
```

Starts recording the execution time data in the file `spy.log` on the `HOME`: disk.

Arguments

```
SpyStart File
```

File

Data type: `string`

The file path and the file name to the file that will contain the execution data.

Program execution

The specified file is opened for writing and the execution time data begins recording in the file.

Recording of execution time data is active until:

- execution of instruction `SpyStop`
- starting program execution from the beginning
- loading a new program
- next **Restart**
- changing from manual to auto and Auto Condition Reset enabled

Error handling

The following recoverable errors are generated and can be handled in an error handler. The system variable `ERRNO` will be set to:

Name	Cause of error
<code>ERR_FILEOPEN</code>	The file in the <code>SpyStart</code> instruction can't be opened.

File format

TASK	INSTR	IN	CODE	OUT
MAIN	FOR i FROM 1 TO 3 DO	0	READY	0
MAIN	mynum:=mynum+i;	1	READY	1

Continues on next page

TASK	INSTR	IN	CODE	OUT
MAIN	ENDFOR	2	READY	2
MAIN	mynum:=mynum+i;	2	READY	2
MAIN	ENDFOR	2	READY	2
MAIN	mynum:=mynum+i;	2	READY	2
MAIN	ENDFOR	2	READY	3
MAIN	SetDo1,1;	3	READY	3
MAIN	IF di1=0 THEN	3	READY	4
MAIN	MoveL p1, v1000, fine, tool0;	4	WAIT	14
MAIN	MoveL p1, v1000, fine, tool0;	111	READY	111
MAIN	ENDIF	108	READY	108
MAIN	MoveL p2, v1000, fine, tool0;	111	WAIT	118
MAIN	MoveL p2, v1000, fine, tool0;	326	READY	326
MAIN	SpyStop;	326	READY	

TASK column shows executed program task.

INSTR column shows executed instruction in specified program task.

IN column shows the time in ms when entering the executed instruction.

CODE column shows if the instruction is READY or the instruction WAIT for completion at OUT time.

OUT column shows the time in ms upon leaving the executed instruction.

All times are given in ms (relative values).

SYSTEM TRAP means that the system is doing something else than execution of RAPID instructions.

If the procedure calls to some NOSTEPIN procedure (module) then the output list shows only the name of the called procedure. This is repeated for every executed instruction in the NOSTEPIN routine.

Limitations

Never use the spy function in production programs because the function increases the cycle time and consumes memory on the mass memory device in use.

Syntax

```
SpyStart
  [File':=']<expression (IN) of string>';'
```

Related information

For information about	See
Stop recording of execution data	SpyStop - Stop recording of time execution data on page 786
Auto condition	<i>Technical reference manual - System parameters</i>

1 Instructions

1.271 SpyStop - Stop recording of time execution data
RobotWare Base

1.271 SpyStop - Stop recording of time execution data

Usage

`SpyStop` is used to stop the recording of time data during execution.
The data, which can be useful for optimizing the execution cycle time, is stored in a file for later analysis.

Basic examples

The following example illustrates the instruction `SpyStop` :
See also [More examples on page 786](#).

Example 1

```
SpyStop;
```

Stops recording the execution time data in the file specified by the previous `SpyStart` instruction.

Program execution

The execution data recording is stopped and the file specified by the previous `SpyStart` instruction is closed. If no `SpyStart` instruction has been executed before then the `SpyStop` instruction is ignored.

More examples

More examples of the instruction `SpyStop` are illustrated below.

Example 1

```
IF debug = TRUE SpyStart "HOME:/spy.log";  
produce_sheets;  
IF debug = TRUE SpyStop;
```

If the debug flag is true then start recording execution data in the file `spy.log` on the HOME: disk. Perform actual production; stop recording, and close the file `spy.log`.

Limitations

Never use the spy function in production programs because the function increases the cycle time and consumes memory on the mass memory device in use.

Syntax

```
SpyStop' ; '
```

Related information

For information about	See
Start recording of execution data	SpyStart - Start recording of execution time data on page 784

1.272 StartLoad - Load a program module during execution

Usage

StartLoad is used to start the loading of a program module into the program memory during execution.

When loading is in progress other instructions can be executed in parallel. The loaded module must be connected to the program task with the instruction WaitLoad before any of its symbols/routines can be used.

The loaded program module will be added to the modules already existing in the program memory.

A program or system module can be loaded in static (default) or dynamic mode. Depending on the used mode, some operations will unload the module or not affect the module at all.

Static mode

The following table shows how two different operations affect a static loaded program or system modules.

	Set PP to main from TP	Open new RAPID program
Program Module	Not affected	Unloaded
System Module	Not affected	Not affected

Dynamic mode

The following table shows how two different operations affect a dynamic loaded program or system modules.

	Set PP to main from TP	Open new RAPID program
Program Module	Unloaded	Unloaded
System Module	Unloaded	Unloaded

Both static and dynamic loaded modules can be unloaded by the instruction UnLoad.

Basic examples

The following example illustrates the instruction StartLoad:

See also [More examples on page 789](#).

Example 1

```
VAR loadsession load1;

! Start loading of new program module PART_B containing routine
  routine_b in dynamic mode
StartLoad \Dynamic, diskhome \File:="PART_B.MOD", load1;

! Executing in parallel in old module PART_A containing routine_a
%"routine_a"%;

! Unload of old program module PART_A
UnLoad diskhome \File:="PART_A.MOD";
```

Continues on next page

1 Instructions

1.272 StartLoad - Load a program module during execution

RobotWare Base

Continued

```
! Wait until loading and linking of new program module PART_B is
  ready
WaitLoad load1;
```

```
! Execution in new program module PART_B
%"routine_b"%;
```

Starts the loading of program module `PART_B.MOD` from `diskhome` into the program memory with instruction `StartLoad`. In parallel with the loading the program executes `routine_a` in module `PART_A.MOD`. Then instruction `WaitLoad` waits until the loading and linking is finished. The module is loaded in dynamic mode.

Variable `load1` holds the identity of the load session updated by `StartLoad` and referenced by `WaitLoad`.

To save linking time the instruction `UnLoad` and `WaitLoad` can be combined in the instruction `WaitLoad` by using the optional argument `\UnLoadPath`.

Arguments

```
StartLoad [\Dynamic] FilePath [\File] LoadNo
```

`[\Dynamic]`

Data type: `switch`

The switch enables loading of a program module in dynamic mode. Otherwise the loading is in static mode.

`FilePath`

Data type: `string`

The file path and the file name to the file that will be loaded into the program memory. The file name shall be excluded when the argument `\File` is used.

`[\File]`

Data type: `string`

When the file name is excluded in the argument `FilePath` it must be defined with this argument.

`LoadNo`

Data type: `loadsession`

This is a reference to the load session that should be used in the instruction `WaitLoad` to connect the loaded program module to the program task.

Program execution

Execution of `StartLoad` will only order the loading and then proceed directly with the next instruction without waiting for the loading to be completed.

The instruction `WaitLoad` will then wait at first for the loading to be completed if it is not already finished, and then it will be linked and initialized. The initiation of the loaded module sets all variables at module level to their initial values.

Unresolved references will default be accepted for this loading operation `StartLoad - WaitLoad`, but it will be a run time error on execution of an unresolved reference.

Continues on next page

To obtain a good program structure that is easy to understand and maintain, all loading and unloading of program modules should be done from the main module, which is always present in the program memory during execution.

For loading of program that contains a `main` procedure to a main program (with another `main` procedure), see instruction `Load`, [Load - Load a program module during execution on page 342](#).

Error handling

The following recoverable errors are generated and can be handled in an error handler. The system variable `ERRNO` will be set to:

Name	Cause of error
<code>ERR_FILNOTFND</code>	File not found.
<code>ERR_LOADNO_INUSE</code>	The variable specified in argument <code>LoadNo</code> is already in use.

More examples

More examples of how to use the instruction `StartLoad` are illustrated below.

Example 1

```
StartLoad \Dynamic, "HOME:/DOORDIR/DOOR1.MOD", load1;
```

Loads the program module `DOOR1.MOD` from the `HOME:` at the directory `DOORDIR` into the program memory. The program module is loaded in dynamic mode.

Example 2

```
StartLoad \Dynamic, "HOME:" \File:="/DOORDIR/DOOR1.MOD", load1;
```

Same as in example 1 but with another syntax.

Example 3

```
StartLoad "HOME:" \File:="/DOORDIR/DOOR1.MOD", load1;
```

Same as in examples 1 and 2 above but the module is loaded in static mode.

Example 4

```
StartLoad \Dynamic, "HOME:" \File:="/DOORDIR/DOOR1.MOD", load1;
WaitLoad load1;
```

is the same as

```
Load \Dynamic, "HOME:" \File:="/DOORDIR/DOOR1.MOD";
```

Limitations

If a power fail comes while running a `StartLoad` instruction, the system will not be able to recover at startup. The controller will probably end up in system failure state, and the system must be restored from a backup.

To minimize this risk, it is better to load several small modules instead of one big/large module.

Syntax

```
StartLoad
  ['\Dynamic ',']
  [FilePath' :='] <expression (IN) of string>
```

Continues on next page

1 Instructions

1.272 StartLoad - Load a program module during execution

RobotWare Base

Continued

```
['\File ':=' <expression (IN) of string> ] ','  
[LoadNo ':=' ] <variable (VAR) of loadsession>';'
```

Related information

For information about	See
Connect the loaded module to the task	WaitLoad - Connect the loaded module to the task on page 1061
Load session	loadsession - Program load session on page 1689
Load a program module	Load - Load a program module during execution on page 342
Unload a program module	UnLoad - Unload a program module during execution on page 1010
Cancel loading of a program module	CancelLoad - Cancel loading of a module on page 78
Procedure call with Late binding	<i>Technical reference manual - RAPID Overview</i>

1.273 StartMove - Restarts robot movement

Usage

`StartMove` is used to resume robot, external axes movement and belonging process after the movement has been stopped

- by the instruction `StopMove`.
- after execution of `StorePath ... RestoPath` sequence.
- after asynchronously raised movements errors, such as `ERR_PATH_STOP` or specific process error after handling in the `ERROR` handler.

For base system it is possible to use this instruction in the following type of program tasks:

- main task `T_ROB1` for restart of the movement in that task.
- any other task for restart of the movements in the main task.

For MultiMove system it is possible to use this instruction in the following type of program tasks:

- motion task, for restart of the movement in that task.
- non motion task, for restart of the movement in the connected motion task. Besides that, if movement is restarted in one connected motion task belonging to a coordinated synchronized task group, the movement is restarted in all the cooperating tasks.

Basic examples

The following examples illustrate the instruction `StartMove`:

Example 1

```
StopMove;
WaitDI ready_input,1;
StartMove;
```

The robot starts to move again when the input `ready_input` is set.

Example 2

```
...
MoveL p100, v100, z10, tool1;
StorePath;
p:= CRobT(\Tool:=tool1);
! New temporary movement
MoveL p1, v100, fine, tool1;
...
MoveL p, v100, fine, tool1;
RestoPath;
StartMove;
...
```

After moving back to a stopped position `p` (in this example equal to `p100`), the robot starts to move again on the basic path level.

Arguments

`StartMove` [`\AllMotionTasks`]

Continues on next page

1 Instructions

1.273 StartMove - Restarts robot movement

RobotWare Base

Continued

`[\AllMotionTasks]`

Data type: switch

Restart the movement of all mechanical units in the system. The switch `[\AllMotionTasks]` can only be used from a non-motion program task.

Program execution

Any processes associated with the stopped movement are restarted at the same time that the motion resumes.



Note

If a `StopMove` instruction has been used to stop movement, a `StartMove` instruction must be executed in the same task that performed the `StopMove`. This behavior is the same regardless of using the argument `\AllMotionTasks` or not.

To restart a `MultiMove` application in synchronized coordinated mode, `StartMove` must be executed in all motion tasks that are involved in coordination.

With the switch `\AllMotionTasks` (only allowed from non-motion program task) the movements for all mechanical units in the system are restarted.

In a base system without the switch `\AllMotionTasks`, the movements for following mechanical units are restarted:

- always the mechanical units in the main task, independent of which task executes the `StartMove` instruction.

In a `MultiMove` system without the switch `\AllMotionTasks` the movements for the following mechanical units are restarted:

- the mechanical units in the motion task executing `StartMove`.
 - the mechanical units in the motion task that are connected to the non motion task executing `StartMove`. Besides that, if mechanical units are restarted in one connected motion task belonging to a coordinated synchronized task group then the mechanical units are restarted in all the cooperated tasks.
-

Error handling

The following recoverable errors are generated and can be handled in an error handler. The system variable `ERRNO` will be set to:

Name	Cause of error
<code>ERR_PATHDIST</code>	The robot is too far from the path (more than 10 mm or 20 degrees) to perform a restart of the interrupted movement. Move the robot closer to the path before attempting <code>RETRY</code> .
<code>ERR_STARTMOVE</code>	The robot is in hold state when executing a <code>StartMove</code> instruction. Wait some time before attempting <code>RETRY</code> .
<code>ERR_PROGSTOP</code>	The robot is in program stop state when executing a <code>StartMove</code> instruction. Wait some time before attempting <code>RETRY</code> .

Continues on next page

Name	Cause of error
ERR_ALRDY_MOVING	The robot is already moving when executing a <code>StartMove</code> instruction. Wait some time before attempting <code>RETRY</code> .

Limitations

Only one of several non-motion tasks is allowed at the same time to do `StopMove` - `StartMove` sequence against some motion task.

It is not possible to do any error recovery if `StartMove` is executed in any error handler.

Syntax

```
StartMove
  ['\AllMotionTasks'];'
```

Related information

For information about	See
Stopping movements	StopMove - Stops robot movement on page 820
Continuing a movement	StartMoveRetry - Restarts robot movement and execution on page 794
More examples	StorePath - Stores the path when an interrupt occurs on page 826 RestoPath - Restores the path after an interrupt on page 618

1 Instructions

1.274 StartMoveRetry - Restarts robot movement and execution *RobotWare Base*

1.274 StartMoveRetry - Restarts robot movement and execution

Usage

`StartMoveRetry` is used to resume robot and external axes movements and belonging processes and also retry the execution from an `ERROR` handler.

This instruction can be used in an `ERROR` handler in the following types of program tasks:

- main task `T_ROB1` in a base system
- any motion task in a *MultiMove* system

Basic examples

The following example illustrates the instruction `StartMoveRetry`:

Example 1

```
VAR robtarget p_err;
...
MoveL p1\ID:=50, v1000, z30, tool1 \WObj:=stn1;
...
ERROR
  IF ERRNO = ERR_PATH_STOP THEN
    StorePath;
    p_err := CRobT(\Tool:= tool1 \WObj:=wobj0);
    ! Fix the problem
    MoveL p_err, v100, fine, tool1;
    RestoPath;
    StartMoveRetry;
  ENDIF
ENDPROC
```

This is an example from a *MultiMove* system with coordinated synchronized movements (two robots working on some rotated work object).

During the movement to position `p1`, the other cooperated robot gets some process error so that the coordinated synchronized movements stops. This robot then gets the error `ERR_PATH_STOP`, and the execution is transferred to the `ERROR` handler.

In the `ERROR` handler, do the following:

- `StorePath` stores the original path, goes to a new path level, and sets the *MultiMove* system in independent mode.
- If there are problems with the robot then initiate movements on the new path level.
- Before `RestoPath` go back to the error position.
- `RestoPath` goes back to the original path level and sets the *MultiMove* system back to synchronized mode again.
- `StartMoveRetry` restarts the interrupted movement and any process. It also transfers the execution back to resume the normal execution.

Continues on next page

Program execution

StartMoveRetry does the following sequence:

- regain to path
- restart any processes associated with the stopped movement
- restart the interrupted movement
- **RETRY** of the program execution

StartMoveRetry does the same as StartMove and RETRY together in one indivisible operation.

Only the mechanical units in the program task that execute StartMoveRetry are restarted.

Error handling

The following recoverable errors are generated and can be handled in an error handler. The system variable ERRNO will be set to:

Name	Cause of error
ERR_PATHDIST	The robot is too far from the path (more than 10 mm or 20 degrees) to perform a restart of the interrupted movement.
ERR_STARTMOVE	The robot is in hold state when executing a StartMoveRetry instruction.
ERR_PROGSTOP	The robot is in program stop state when executing a StartMoveRetry instruction.
ERR_ALRDY_MOVING	The robot is already moving when executing a StartMoveRetry instruction.

Limitations

Can only be used in an ERROR handler in a motion task.

In a MultiMove system executing coordinated synchronized movements the following programming rules must be followed in the ERROR handler:

- StartMoveRetry must be used in all cooperated program tasks.
- If movement is needed in any ERROR handler then the instructions StorePath ... RestoPath must be used in all cooperated program tasks.
- The program must move the robot back to the error position before RestoPath is executed if the robot was moved on the StorePath level.

Syntax

```
StartMoveRetry ';' ;'
```

Related information

For information about	See
Stopping movements	StopMove - Stops robot movement on page 820
Continuing a movement	StartMove - Restarts robot movement on page 791
Resume execution after an error	RETRY - Resume execution after an error on page 620

Continues on next page

1 Instructions

1.274 StartMoveRetry - Restarts robot movement and execution

RobotWare Base

Continued

For information about	See
Store/restore path	StorePath - Stores the path when an interrupt occurs on page 826 RestoPath - Restores the path after an interrupt on page 618

1.275 STCalib - Calibrate a Servo Tool

Usage

STCalib is used to calibrate the distance between the tool tips. This is necessary after tip change or tool change, and it is recommended after performing a tip dress or after using the tool for a while.

Note! The tool performs two close/open movements during the calibration. The first close movement will detect the tip contact position.

Basic examples

The following examples illustrate the instruction STCalib:

Example 1

```
VAR num curr_tip_wear;
VAR num retval;
CONST num max_adjustment := 20;
```

```
STCalib gun1 \ToolChg;
```

Calibrate a servo gun after a toolchange. Wait until the gun calibration has finished before continuing with the next Rapid instruction.

Example 2

```
STCalib gun1 \ToolChg \Conc;
```

Calibrate a servo gun after a toolchange. Continue with the next Rapid instruction without waiting for the gun calibration to be finished.

Example 3

```
STCalib gun1 \TipChg;
```

Calibrate a servo gun after a tipchange.

Example 4

```
STCalib gun1 \TipWear \RetTipWear := curr_tip_wear;
```

Calibrate a servo gun after tip wear. Save the tip wear in variable curr_tip_wear.

Example 5

```
STCalib gun1 \TipChg \RetPosAdj:=retval;
IF retval > max_adjustment THEN
TPWrite "The tips are lost!";
...
```

Calibrate a servo gun after a tipchange. Check if the tips are missing.

Example 6

```
STCalib gun1 \TipChg \PrePos:=10;
```

Calibrate a servo gun after a tipchange. Move fast to position 10 mm then start to search for contact position with slower speed.

Example 7

Example of non valid combination:

```
STCalib gun1 \TipWear \RetTipWear := curr_tip_wear \Conc;
```

Continues on next page

1 Instructions

1.275 STCalib - Calibrate a Servo Tool

Servo Tool Control

Continued

Perform a tip wear calibration. Continue with the next Rapid instruction without waiting for the gun calibration to be finished. The parameter `curr_tip_wear` will in this case not hold any valid value since the `\Conc` switch is used (The next Rapid instruction will start to execute before the calibration process is finished).

Arguments

```
STCalib ToolName [\ToolChg] | [\TipChg] | [\TipWear] [\RetTipWear]  
[\RetPosAdj] [\PrePos] [\Conc]
```

ToolName

Data type: string

The name of the mechanical unit.

[\ToolChg]

Data type: switch

Calibration after a tool change.

[\TipChg]

Data type: switch

Calibration after a tip change.

[\TipWear]

Data type: switch

Calibration after tip wear.

[\RetTipWear]

Data type: num

The achieved tip wear [mm].

[\RetPosAdj]

Data type: num

The positional adjustment since the last calibration [mm].

[\PrePos]

Data type: num

The position to move with high speed before the search for contact position with slower speed is started [mm].

[\Conc]

Data type: switch

Subsequent instructions are executed while the gun is moving. The argument can be used to shorten cycle time. This is useful when, for example, two guns are controlled at the same time.

Program execution

Calibration modes

If the mechanical unit exists then the servo tool is ordered to calibrate. The calibration is done according to the switches, see below. If the `RetTipWear` parameter is used then the tip wear is updated.

Continues on next page

Calibration after toolchange:

The tool will close with slow speed waiting for tips in contact to open fast, close fast to a low force, and open again in one sequence. The tip wear will remain unchanged.

Calibration after tipchange:

The tool will close with slow speed waiting for tips in contact to open fast, close fast to a low force, and open again in one sequence. The tip wear will be reset.

Calibration after tipwear:

The tool will close with high speed to the contact position, open fast, close fast to a low force, and open again in one sequence. The tip wear will be updated.

NOTE! If the switch `Conc` is used then the instruction will be considered ready once started and therefore the return value `RetTipWear` will not be available. In this case the `RetTipWear` will be returned by the function `STIsOpen`. For more details, see RobotWareOS functions - `STIsOpen`.

Positional adjustment

The optional argument `RetPosAdj` can be used to detect, for example, if the tips are lost after a tip change. The parameter will hold the value of the positional adjustment since the last calibration. The value can be negative or positive.

Using a pre-position

To speed up the calibration it is possible to define a pre-position. When the calibration starts the gun arm will run fast to the pre-position, stop, and then continue slowly*) forward to detect the tip contact position. If a pre-position is used then select it carefully! It is important that the tips do not get in contact until *after* the pre-position is reached! Otherwise the accuracy of the calibration will become poor and motion supervision errors may possibly occur. A pre-position will be ignored if it is larger than the current gun position (in order not to slow down the calibration).

*) The second movement will also be fast if the `\TipWear` option is used.

Error handling

The following recoverable errors are generated and can be handled in an error handler. The system variable `ERRNO` will be set to:

Name	Cause of error
<code>ERR_NO_SGUN</code>	The specified servo tool name is not a configured servo tool.
<code>ERR_SGUN_ESTOP</code>	Emergency stop during servo tool movement. The instruction is invoked from a background task and there is an emergency stop, the instruction will be finished. Note that if the instruction is invoked from the main task then the program pointer will be stopped at the instruction, and the instruction will be restarted from the beginning at program restart.
<code>ERR_SGUN_MOTOFF</code>	The instruction is invoked from a background task and the system is in motors off state.
<code>ERR_SGUN_NEGVAL</code>	The argument <code>PrePos</code> is specified with a value less than zero.

Continues on next page

1 Instructions

1.275 STCalib - Calibrate a Servo Tool

Servo Tool Control

Continued

Name	Cause of error
ERR_SGUN_NOTACT	The servo tool mechanical unit is not activated. Use instruction <code>ActUnit</code> to activate the servo tool.
ERR_SGUN_NOTINIT	The servo tool position is not initialized. The servo tool position must be initialized the first time the gun is installed or after a fine calibration is made. Use the service routine <code>ManServiceCalib</code> or perform a tip change calibration. The tip wear will be reset.
ERR_SGUN_NOTOPEN	The gun is not open when <code>STCalib</code> is invoked.
ERR_SGUN_NOTSYNC	The servo tool tips are not synchronized. The servo tool tips must be synchronized if the revolution counter has been lost and/or updated. No process data such as tip wear will be lost.

Syntax

```
STCalib
[ 'ToolName' := ] < expression (IN) of string > ','
[ '\ToolChg' | '\TipChg' | '\TipWear'
[ '\RetTipWear' := < variable or persistent(INOUT) of num >
  ]';'
[ '\RetPosAdj' := < variable or persistent(INOUT) of num > ]';'
[ '\PrePos' := < expression (IN) of num > ]'
[ '\Conc' ]';'
```

Related information

For information about	See
Open a servo tool	STOpen - Open a Servo Tool on page 818
Close a servo tool	STClose - Close a Servo Tool on page 801

1.276 STClose - Close a Servo Tool

Usage

STClose is used to close the Servo Tool.

Basic examples

The following examples illustrate the instruction STClose:

Example 1

```
VAR num curr_thickness1;
VAR num curr_thickness2;
```

```
STClose gun1, 1000, 5;
```

Close the servo gun with tip force 1000 N and plate thickness 5 mm. Wait until the gun is closed before continuing with the next Rapid instruction.

Example 2

```
STClose gun1, 2000, 3\RetThickness:=curr_thickness;
```

Close the servo gun with tip force 2000 N and plate thickness 3 mm. Get the measured thickness in variable curr_thickness.

Example 3

Concurrent mode:

```
STClose gun1, 1000, 5 \Conc;
STClose gun2, 2000, 3 \Conc;
```

Close the servo gun1 with tip force 1000 N and plate thickness 5 mm. Continue the program execution without waiting for gun1 to be closed, and close the servo gun2 with tip force 2000N and plate thickness 3 mm. Continue the execution of the Rapid program without waiting for gun2 to be closed.

Example 4

```
IF STIsClosed (gun1)\RetThickness:=curr_thickness1 THEN
  IF curr_thickness1 < 0.2 Set weld_start1;
ENDIF
IF STIsClosed (gun2)\RetThickness:=curr_thickness2 THEN
  IF curr_thickness2 < 0.2 Set weld_start2;
ENDIF
```

Get the measured thickness in the function STIsClosed variable curr_thickness1 and curr_thickness2.

Example 5

Example of non valid combination:

```
STClose gun1, 2000, 3\RetThickness:=curr_thickness \Conc;
```

Close the servo gun and continue with the Rapid program execution. The parameter curr_thickness will in this case not hold any valid value since the \Conc switch is used (The next Rapid instruction will start to execute before the gun is closed).

Arguments

```
STClose ToolName TipForce Thickness [\RetThickness][\Conc]
```

Continues on next page

1 Instructions

1.276 STClose - Close a Servo Tool

Servo Tool Control

Continued

ToolName

Data type: `string`

The name of the mechanical unit.

TipForce

Data type: `num`

The desired tip force [N].

Thickness

Data type: `num`

The expected contact position for the servo tool [mm].

`[\RetThickness]`

Data type: `num`

The achieved thickness [mm], will only get a value if the `\Conc` switch is not used.

`[\Conc]`

Data type: `switch`

Subsequent instructions are executed while the gun is moving. The argument can be used to shorten cycle time. This is useful when e.g. two guns are controlled at the same time.

Program execution

If the mechanical unit exists then the servo tool is ordered to close to the expected thickness and force.

The closing will start to move the tool arm to the expected contact position (thickness). The movement is stopped in this position, and a switch from position control mode to force control mode is done.

The tool arm is moved with max speed and acceleration as it is defined in the system parameters for corresponding external axis. As for other axes movements, the speed is reduced in manual mode.

When the desired tip force is achieved the instruction is ready and the achieved thickness is returned if the optional argument `RetThickness` is specified.

NOTE! If the switch `Conc` is used then the instruction will be considered to be ready once started and therefore the return value `RetThickness` will not be available. In this case the `RetThickness` will be returned by the function `STIsClosed`. For more details see RobotWare OS functions - `STIsClosed`.

It is possible to close the tool during a programmed robot movement as long as the robot movement does not include a movement of the tool arm.

For more details see Servo tool motion control.

Continues on next page

Error handling

The following recoverable errors are generated and can be handled in an error handler. The system variable `ERRNO` will be set to:

Name	Cause of error
ERR_NO_SGUN	The specified servo tool name is not a configured servo tool.
ERR_SGUN_ESTOP	Emergency stop during servo tool movement. The instruction is invoked from a background task and there is an emergency stop, the instruction will be finished. Note that if the instruction is invoked from the main task then the program pointer will be stopped at the instruction, and the instruction will be restarted from the beginning at program restart.
ERR_SGUN_MOTOFF	The instruction is invoked from a background task and the system is in motors off state.
ERR_SGUN_NEGVAL	The argument <code>PrePos</code> is specified with a value less than zero.
ERR_SGUN_NOTACT	The servo tool mechanical unit is not activated. Use instruction <code>ActUnit</code> to activate the servo tool.
ERR_SGUN_NOTINIT	The servo tool position is not initialized. The servo tool position must be initialized the first time the gun is installed or after a fine calibration is made. Use the service routine <code>ManServiceCalib</code> or perform a tip change calibration. The tip wear will be reset.
ERR_SGUN_NOTOPEN	The gun is not open when <code>STClose</code> is invoked.
ERR_SGUN_NOTSYNC	The servo tool tips are not synchronized. The servo tool tips must be synchronized if the revolution counter has been lost and/or updated. No process data such as tip wear will be lost.

Syntax

```
STClose
[ 'ToolName' := ] < expression (IN) of string > ','
[ 'Tipforce' := ] < expression (IN) of num > ','
[ 'Thickness' := ] < expression (IN) of num > ]
[ '\ 'RetThickness' := < variable or persistent (INOUT) of num
  > ]
[ '\ 'Conc ]
```

Related information

For information about	See
Open a servo tool	STOpen - Open a Servo Tool on page 818

1 Instructions

1.277 StepBwdPath - Move backwards one step on path *RobotWare Base*

1.277 StepBwdPath - Move backwards one step on path

Usage

`StepBwdPath` is used to move the TCP backwards on the robot path from a `RESTART` event routine.

It is up to the user to introduce a restart process flag so `StepBwdPath` in the `RESTART` event routine is only executed at process restart and not at all program restarts.

This instruction can only be used in the main task `T_ROB1` or, if in a MultiMove System, in Motion tasks.

Basic examples

The following example illustrates the instruction `StepBwdPath`:

Example 1

```
StepBwdPath 30, 1;  
StepBwdPath 30, 1;
```

The first instruction move backwards 30 mm. The second instruction move backwards 30 mm further.

Arguments

```
StepBwdPath StepLength StepTime
```

StepLength

Data type: num

Specifies the distance, in millimeters, to move backwards during this step. This argument must be a positive value.

StepTime

Data type: num

This argument is obsolete. Set it to 1.

Program execution

The robot moves back on its path for the specified distance. The path is exactly the same in the reverse way as it was before the stop occurred. In the case of a quick stop or emergency stop, the `RESTART` event routine is called after the regain phase has completed so the robot will already be back on its path when this instruction is executed.

The actual speed for this movement is the programmed speed on the movement order but limited to 250 mm/s.

Following properties are valid in MultiMove System - Synchronized Coordinated Movements:

- All involved mechanical units are moved backward simultaneously and coordinated
- Each executed `StepBwdPath` in any involved program task results in one new backward movement step (without need of any `StartMove`)

Continues on next page

- To restart and continue the interrupted process movements, instruction `StartMove` must be executed in all involved program tasks

Error handling

If an attempt is made to move beyond these limits then the error handler will be called with `ERRNO` set to `ERR_BWDLIMIT`.

Limitations

After the program has been stopped it is possible to step backwards on the path with the following limits:

- The `StepBwdPath` movements are limited to the last fine point, and the length of the movement order history that normally is five.

Syntax

```
StepBwdPath  
  [ StepLength ::= ' ] < expression (IN) of num > ', '  
  [ StepTime ::= ' ] < expression (IN) of num > ';'
```

Related information

For information about	See
Motion in general	<i>Technical reference manual - RAPID Overview</i>
Positioning instructions	<i>Technical reference manual - RAPID Overview</i>
<i>Advanced RAPID</i>	<i>Application manual - Controller software IRC5</i>

1 Instructions

1.278 STIndGun - Sets the servo tool in independent mode

Servo Tool Control

1.278 STIndGun - Sets the servo tool in independent mode

Usage

STIndGun (*Servo Tool independent gun*) is used to set the servo tool (e.g. gun or gripper) in independent mode and thereafter move the tool to a specified independent position. The tool will stay in independent mode until the instruction STIndGunReset is executed.

During independent mode the control of the tool is separated from the robot. The tool can be closed, opened, calibrated, or moved to a new independent position, but it will not follow coordinated robot movements.

Independent mode is useful if the tool performs a task that is independent of the robot's task, e.g. tip dressing of a stationary gun.

Basic examples

The following example illustrates the instruction STIndGun:

Example 1

This procedure could be run from a background task while the robot in the main task can continue with, for example, move instructions.

```
PROC tipdress()

    ! Note that the gun will move to current robtargt position, if
    ! already in independent mode.
    STIndGunReset gun1;
    ...
    STIndGun gun1, 30;
    StClose gun1, 1000, 5;
    WaitTime 10;
    STOpen gun1;
    ...
    STIndGunReset gun1;

ENDPROC
```

Independent mode is activated and the gun is moved to an independent position (30 mm). During independent mode the instructions StClose, WaitTime, and STOpen are executed without interfering with robot motion. The instruction

Continues on next page

StIndGunReset will take the gun out of independent mode and move the gun to current robtarget position.

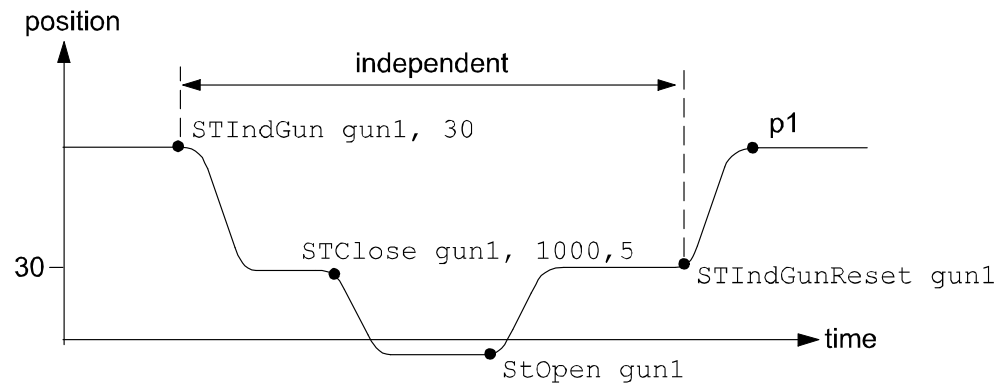

xx0500002342

The position p1 depends on the position of the gun given in the robtarget just performed by the robot.

Arguments

```
STIndGun ToolName GunPos
```

ToolName

Data type: string

The name of the mechanical unit.

GunPos

Data type: num

The position (stroke) of the servo gun in mm.

Syntax

```
STIndGun
  [ ToolName ':=' ] < expression (IN) of string > ','
  [ GunPos ':=' < expression (IN) of num > ]';'
```

1 Instructions

1.279 STIndGunReset - Resets the servo tool from independent mode
Servo Tool Control

1.279 STIndGunReset - Resets the servo tool from independent mode

Usage

STIndGunReset (*Servo Tool independent gun reset*) is used to reset the servo tool from independent mode and thereafter move the gun to current rotarget position.

Basic examples

The following example illustrates the instruction STIndGunReset:

```
STIndGunReset gun1;
```

Arguments

```
STIndGunReset ToolName
```

ToolName

Data type: string

The name of the mechanical unit.

Program execution

The instruction will reset the gun from independent mode and move the gun to current rotarget position. During this movement the coordinated speed of the gun must be zero, otherwise the reset will be delayed. The coordinated speed will be zero if the robot is standing still or if the current robot movement includes a "zero movement" of the gun.

Limitations

Note that the reset movement of the gun only will be finished if the coordinated speed of the tool between two points are zero or if the consecutive point is a stop point.

Syntax

```
STIndGunReset  
[ToolName ':=']<expression (IN) of string>';'
```

1.280 SToolRotCalib - Calibration of TCP and rotation for stationary tool

Usage

`SToolRotCalib` (*Stationary Tool Rotation Calibration*) is used to calibrate the TCP and rotation of a stationary tool.

The position of the robot and its movements are always related to its tool coordinate system, i.e. the TCP and tool orientation. To get the best accuracy it is important to define the tool coordinate system as correctly as possible.

The calibration can also be done with a manual method using the FlexPendant, see *Operating manual - IRC5 with FlexPendant*.

Description

To define the TCP and rotation of a stationary tool, you need a movable pointing tool mounted on the end effector of the robot.

Before using the instruction `SToolRotCalib`, some preconditions must be fulfilled:

- The stationary tool that is to be calibrated must be mounted stationary and defined with the correct component `robhold` (`FALSE`).
- The pointing tool (`robhold TRUE`) must be defined and calibrated with the correct TCP values.
- If using the robot with absolute accuracy then the load and center of gravity for the pointing tool should be defined. `LoadIdentify` can be used for the load definition.
- The pointing tool, `wobj0`, and `PDispOff` must be activated before jogging the robot.
- Jog the TCP of the pointing tool as close as possible to the TCP of the stationary tool (origin of the tool coordinate system) and define a `robtarget` for the reference point `RefTip`.
- Jog the robot without changing the tool orientation so the TCP of the pointing tool is pointing at some point on the positive z-axis of the tool coordinate system, and define a `robtarget` for point `ZPos`.
- Jog the robot without changing the tool orientation so the TCP of the pointing tool is pointing at some point on the positive x-axis of the tool coordinate system, and define a `robtarget` for point `XPos`.

As a help for pointing out the positive z-axis and x-axis, some type of elongator tool can be used.

Continues on next page

1 Instructions

1.280 SToolRotCalib - Calibration of TCP and rotation for stationary tool

RobotWare Base

Continued

Definition of robtargets RefTip, ZPos, and XPos. See figure below.

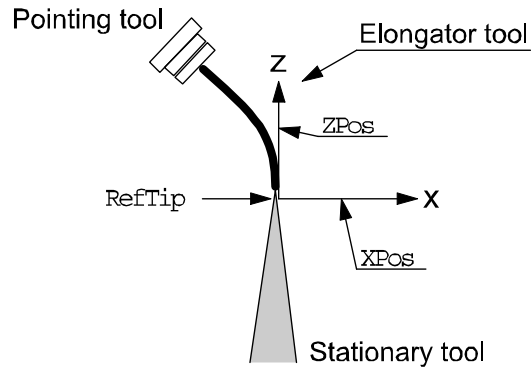

xx0500002343



Note

It is not recommended to modify the positions RefTip, ZPos, and XPos in the instruction SToolRotCalib.

Basic examples

The following example illustrates the instruction SToolRotCalib:

Example 1

```
! Created with pointing TCP pointing at the stationary tool
! coordinate system
CONST robtarget pos_tip := [...];
CONST robtarget pos_z := [...];
CONST robtarget pos_x := [...];

PERS tooldata tool1:= [ FALSE, [[0, 0, 0], [1, 0, 0, 0]], [0, [0,
    0, 0], [1, 0, 0, 0], 0, 0, 0]];

!Instructions for creating or ModPos of pos_tip, pos_z and pos_x
MoveJ pos_tip, v10, fine, point_tool;
MoveJ pos_z, v10, fine, point_tool;
MoveJ pos_x, v10, fine, point_tool;

SToolRotCalib pos_tip, pos_z, pos_x, tool1;
```

The position of the TCP (tframe.trans) and the tool orientation (tframe.rot) of tool1 in the world coordinate system is calculated and updated.

Arguments

```
SToolRotCalib RefTip ZPos XPos Tool
```

RefTip

Data type: robtarget

The point where the TCP of the pointing tool is pointing at the stationary tool TCP to calibrate.

Continues on next page

1.280 SToolRotCalib - Calibration of TCP and rotation for stationary tool

RobotWare Base
Continued

ZPos

Data type: robtarget

The elongator point that defines the positive z direction.

XPos

Data type: robtarget

The elongator point that defines the positive x direction.

Tool

Data type: tooldata

The persistent variable of the tool that is to be calibrated.

Program execution

The system calculates and updates the TCP (`tframe.trans`) and the tool orientation (`tframe.rot`) in the specified `tooldata`. The calculation is based on the specified 3 `robtarget`. The remaining data in `tooldata` is not changed.

Syntax

```
SToolRotCalib
  [RefTip ':=' ] <expression (IN) of robtarget>','
  [ZPos ':=' ] <expression (IN) of robtarget>','
  [XPos ':=' ] <expression (IN) of robtarget>','
  [Tool ':=' ] <persistent (PERS) of tooldata>';'
```

Related information

For information about	See
Calibration of TCP for a moving tool	MToolTCPCalib - Calibration of TCP for moving tool on page 496
Calibration of rotation for a moving tool	MToolRotCalib - Calibration of rotation for moving tool on page 493
Calibration of TCP for a stationary tool	MToolTCPCalib - Calibration of TCP for moving tool on page 496

1 Instructions

1.281 SToolTCPCalib - Calibration of TCP for stationary tool *RobotWare Base*

1.281 SToolTCPCalib - Calibration of TCP for stationary tool

Usage

`SToolTCPCalib` (*Stationary Tool TCP Calibration*) is used to calibrate the Tool Center Point - TCP for a stationary tool.

The position of the robot and its movements are always related to its tool coordinate system, i.e. the TCP and tool orientation. To get the best accuracy it is important to define the tool coordinate system as correctly as possible.

The calibration can also be done with a manual method using the FlexPendant (described in *Operating manual - IRC5 with FlexPendant*).

Description

To define the TCP of a stationary tool, you need a movable pointing tool mounted on the end effector of the robot.

The following are the prerequisites before using the instruction `SToolTCPCalib`:

- The stationary tool that is to be calibrated must be mounted stationary and defined with the correct component `robhold` (`FALSE`).
- The pointing tool (`robhold` `TRUE`) must be defined and calibrated with the correct TCP values.
- If using the robot with absolute accuracy then the load and center of gravity for the pointing tool should be defined. `LoadIdentify` can be used for the load definition.
- The pointing tool, `wobj0` and `PDispOff`, must be activated before jogging the robot.
- Jog the TCP of the pointing tool as close as possible to the TCP of the stationary tool and define a `robtarget` for the first point `p1`.
- Define the further three positions `p2`, `p3`, and `p4`, all with different orientations.
- It is recommended that the TCP is pointing in different directions to obtain a reliable statistical result.

Definition of 4 `robtargets` `p1...p4`. See figure below.

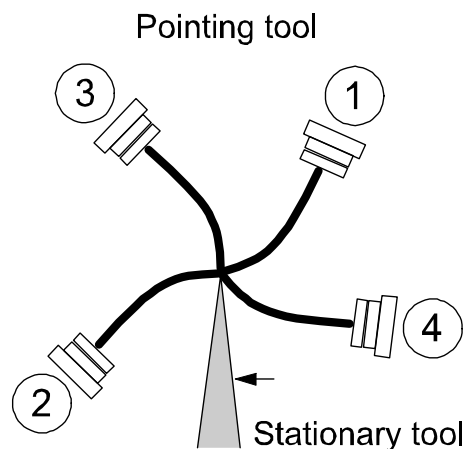

xx0500002344

Continues on next page

**Note**

It is not recommended to modify the positions `Pos1` to `Pos4` in the instruction `SToolTCPCalib`.

The reorientation between the 4 positions should be as big as possible, putting the robot in different configurations. Its also good practice to check the quality of the TCP after a calibration. Which can be performed by reorientation of the tool to check if the TCP is standing still.

Basic example

The following example illustrates the instruction `SToolTCPCalib`:

Example 1

```
! Created with pointing TCP pointing at the stationary TCP
CONST robtarget p1 := [...];
CONST robtarget p2 := [...];
CONST robtarget p3 := [...];
CONST robtarget p4 := [...];

PERS tooldata tool1:= [ FALSE, [[0, 0, 0], [1, 0, 0, 0]], [0,001,
    [0, 0, 0.001], [1, 0, 0, 0], 0, 0, 0]];
VAR num max_err;
VAR num mean_err;
! Instructions for creating or ModPos of p1 - p4
MoveJ p1, v10, fine, point_tool;
MoveJ p2, v10, fine, point_tool;
MoveJ p3, v10, fine, point_tool;
MoveJ p4, v10, fine, point_tool;

SToolTCPCalib p1, p2, p3, p4, tool1, max_err, mean_err;
```

The TCP value (`tframe.trans`) of `tool1` will be calibrated and updated. `max_err` and `mean_err` will hold the max error in mm from the calculated TCP and the mean error in mm from the calculated TCP, respectively.

Arguments

```
SToolTCPCalib Pos1 Pos2 Pos3 Pos4 Tool MaxErr MeanErr
```

`Pos1`

Data type: `robtarget`

The first approach point.

`Pos2`

Data type: `robtarget`

The second approach point.

`Pos3`

Data type: `robtarget`

The third approach point.

Continues on next page

1 Instructions

1.281 SToolTCPCalib - Calibration of TCP for stationary tool

RobotWare Base

Continued

Pos4

Data type: robtarget

The fourth approach point.

Tool

Data type: tooldata

The persistent variable of the tool that is to be calibrated.

MaxErr

Data type: num

The maximum error in mm for one approach point.

MeanErr

Data type: num

The average distance that the approach points are from the calculated TCP, i.e. how accurately the robot was positioned relative to the stationary TCP.

Program execution

The system calculates and updates the TCP value in the world coordinate system (`tframe.trans`) in the specified `tooldata`. The calculation is based on the specified 4 `robtarget`. The remaining data in `tooldata`, such as tool orientation (`tframe.rot`), is not changed.

Syntax

```
SToolTCPCalib
  [ Pos1 ':' ] < expression (IN) of robtarget > ','
  [ Pos2 ':' ] < expression (IN) of robtarget > ','
  [ Pos3 ':' ] < expression (IN) of robtarget > ','
  [ Pos4 ':' ] < expression (IN) of robtarget > ','
  [ Tool ':' ] < persistent (PERS) of tooldata > ','
  [ MaxErr ':' ] < variable (VAR) of num > ','
  [ MeanErr ':' ] < variable (VAR) of num > ';'
;
```

Related information

For information about	See
Calibration of TCP for a moving tool	SToolTCPCalib - Calibration of TCP for stationary tool on page 812
Calibration of rotation for a moving tool	MToolRotCalib - Calibration of rotation for moving tool on page 493
Calibration of TCP and rotation for a stationary tool	SToolRotCalib - Calibration of TCP and rotation for stationary tool on page 809

1.282 Stop - Stops program execution

Usage

`Stop` is used to stop the program execution. Any movement performed at the time will be finished before the `Stop` instruction is ready.

Basic examples

The following example illustrates the instruction `Stop`:

See also [More examples on page 817](#).

Example 1

```
TPWrite "The line to the host computer is broken";
Stop;
```

Program execution stops after a message has been written on the FlexPendant.

Arguments

```
Stop [ \NoRegain ] | [ \AllMoveTasks ]
```

[\NoRegain]

Data type: `switch`

Specifies for the next program start, whether or not the affected mechanical unit should return to the stop position.

If the argument `\NoRegain` is set then the robot and external axes will not return to the stop position (if they have been jogged away from it).

If the argument is omitted and if the robot or external axes have been jogged away from the stop position then the robot displays a question on the FlexPendant. The user can then answer whether or not the robot should return to the stop position.

[\AllMoveTasks]

Data type: `switch`

Specifies that programs in all running normal tasks besides the actual task should be stopped.

If the argument is omitted then only the program in the task that executes the instruction will be stopped.

Program execution

The instruction stops program execution when the affected mechanical units in the actual motion task have reached zero speed for the movement it is performing at the time, and stands still. Program execution can then be restarted from the next instruction.

If the instruction is used without any switches then only the program in that task will be affected.

If the `AllMoveTasks` switch is used in a task (Normal, Static, or Semistatic) then the program in that task and all normal tasks will stop. See more about declaration of tasks in documentation for System Parameters

Continues on next page

1 Instructions

1.282 Stop - Stops program execution

RobotWare Base

Continued

The NoRegain switch is only possible to use in motion tasks since it only concerns the motion path.

If there is a Stop instruction in an event routine then the execution of the routine will be stopped, and the execution continues as described in [Stop on page 816](#).

If there is a Stop\AllMoveTasks instruction in an event routine in a MultiMove system, then the task containing the instruction continues as described in [Stop on page 816](#), and all other motion tasks executing an event routine continues as described in [Stop \AllMoveTasks on page 816](#) (same effect as for normal program stop during execution of the event routine).

Stop

Event routines	Effect by stop instruction
POWER ON	The execution is stopped for all tasks. The execution continues in the event routine at the next start order.
START	The execution is stopped for all tasks. The execution continues in the event routine at the next start order.
RESTART	The execution is stopped for all tasks. The execution continues in the event routine at the next start order.
STOP	The execution is stopped. The execution does not continue in the event routine at the next start order.
QSTOP	The execution is stopped. The execution does not continue in the event routine at the next start order.
RESET	The execution is stopped. The execution does not continue in the event routine at the next start order.

Stop \AllMoveTasks

Event routines	Effect by Stop \AllMoveTasks instruction
POWER ON	The execution is stopped for all tasks. The execution continues in the event routine at the next start order.
START	The execution is stopped for all tasks. The execution continues in the event routine at the next start order.
RESTART	The execution is stopped for all tasks. The execution continues in the event routine at the next start order.
STOP	The execution is stopped for all tasks. The execution does not continue in the event routine at the next start order.
QSTOP	The execution is stopped for all tasks. The execution does not continue in the event routine at the next start order.
RESET	The execution is stopped. The execution does not continue in the event routine at the next start order.

Continues on next page

More examples

More examples of how to use the instruction `Stop` are illustrated below.

Example 1

```
MoveL p1, v500, fine, tool1;
TPWrite "Jog the robot to the position for pallet corner 1";
Stop \NoRegain;
p1_read := CRobT(\Tool:=tool1 \WObj:=wobj0);
MoveL p2, v500, z50, tool1;
```

Program execution stops with the robot at `p1`. The operator jogs the robot to `p1_read`. For the next program start the robot does not regain to `p1`, so the position `p1_read` can be stored in the program.

Syntax

```
Stop
[ '\ ' NoRegain ] '|'
[ '\ ' AllMoveTasks ]';'
```

Related information

For information about	See
Terminating program execution	EXIT - Terminates program execution on page 207
Only stopping robot movements	StopMove - Stops robot movement on page 820
Stop program for debugging	Break - Break program execution on page 51

1 Instructions

1.283 STOpen - Open a Servo Tool *Servo Tool Control*

1.283 STOpen - Open a Servo Tool

Usage

STOpen is used to open the Servo Tool.

Basic examples

The following examples illustrate the instruction STOpen:

Example 1

```
STOpen gun1;
```

Open the servo tool `gun1`. Wait until the gun is opened before continuing with the next Rapid instruction.

Example 2

```
STOpen gun1 \Conc;
```

Open the servo tool `gun1`. Continue with the next Rapid instruction without waiting for the gun to be opened.

Example 3

```
STOpen "SERVOGUN"\WaitZeroSpeed;
```

Stop the servo tool `SERVOGUN`, wait until any coordinated movement has finished, and then open the servo tool `SERVOGUN`.

Arguments

```
STOpen ToolName [\WaitZeroSpeed] [\Conc]
```

ToolName

Data type: string

The name of the mechanical unit.

[\WaitZeroSpeed]

Data type: switch

Stop the servo tool, wait until any coordinated movement has finished, and then open the servo tool.

[\Conc]

Data type: switch

Subsequent instructions are executed while the gun is moving. The argument can be used to shorten cycle time. This is useful when, for example, two guns are controlled at the same time.

Program execution

If the mechanical unit exists then the servo tool is ordered to open. The tip force is reduced to zero and the tool arm is moved back to the `pre_close` position.

The tool arm is moved with max speed and acceleration as it is defined in the system parameters for the corresponding external axis. As for other axes movements, the speed is reduced in manual mode.

Continues on next page

It is possible to open the tool during a programmed robot movement as long as the robot movement does not include a movement of the tool arm. If the tool is opened during such movement then an error 50251 Tool opening failed will be displayed. The switch `WaitZeroSpeed` can be used to reduce the risk for this error.

If the switch `Conc` is used then the instruction will be considered to be ready before the servo tool is opened. It is recommended that the function `STIsOpen` is used after `STOpen` to avoid any problems in concurrent mode.

For more details, see Servo tool motion control.

Error handling

The following recoverable errors are generated and can be handled in an error handler. The system variable `ERRNO` will be set to:

Name	Cause of error
<code>ERR_NO_SGUN</code>	The specified servo tool name is not a configured servo tool.
<code>ERR_SGUN_NOTACT</code>	The servo tool mechanical unit is not activated. Use instruction <code>ActUnit</code> to activate the servo tool.
<code>ERR_SGUN_NOTINIT</code>	The servo tool position is not initialized. The servo tool position must be initialized the first time the gun is installed or after a fine calibration is made. Use the service routine <code>ManServiceCalib</code> or perform a tip change calibration. The tip wear will be reset.
<code>ERR_SGUN_NOTSYNC</code>	The servo tool tips are not synchronized. The servo tool tips must be synchronized if the revolution counter has been lost and/or updated. No process data such as tip wear will be lost.



Note

If the instruction is invoked from a background task and there is an emergency stop the instruction will be finished without an error.

Syntax

```
STOpen
[ 'ToolName ':=' ] < expression (IN) of string > ','
[ '\WaitZeroSpeed' ] ','
[ '\Conc ]'
```

Related information

For information about	See
Close a servo tool	STClose - Close a Servo Tool on page 801

1 Instructions

1.284 StopMove - Stops robot movement *RobotWare Base*

1.284 StopMove - Stops robot movement

Usage

`StopMove` is used to stop robot and external axes movements and any belonging process temporarily. If the instruction `StartMove` is given then the movement and process resumes.

This instruction can, for example, be used in a trap routine to stop the robot temporarily when an interrupt occurs.

For base system it is possible to use this instruction in the following type of program tasks:

- main task `T_ROB1` for stopping the movement in that task.
- any other task for stopping the movements in the main task.

For MultiMove systems it is possible to use this instruction in following type of program tasks:

- motion task for stopping the movement in that task.
- non-motion task for stopping the movement in the connected motion task. Besides that, if movement is stopped in one motion task belonging to a coordinated synchronized task group then the movement is stopped in all the cooperated tasks.



Note

The `StopMove` and `StartMove` sequence must always be executed by the same task.

Basic examples

The following example illustrates the instruction `StopMove`:

See also [More examples on page 821](#).

Example 1

```
StopMove;  
WaitDI ready_input, 1;  
StartMove;
```

The robot movement is stopped until the input, `ready_input` is set.

Arguments

```
StopMove [\Quick] [\AllMotionTasks]
```

[`\Quick`]

Data type: `switch`

Stops the robot on the path as fast as possible.

Without the optional parameter `\Quick`, the robot stops on the path, but the braking distance is longer (same as for normal Program Stop).

[`\AllMotionTasks`]

Data type: `switch`

Continues on next page

Stop the movement of all mechanical units in the system. The switch `[\AllMotionTasks]` can only be used from a non-motion program task.

Program execution

The movements of the robot and external axes stop without the brakes being engaged. Any processes associated with the movement in progress are stopped at the same time as the movement is stopped.

Program execution continues after waiting for the robot and external axes to stop (standing still).

With the switch `\AllMotionTasks` (only allowed from non-motion program task) the movements for all mechanical units in the system are stopped.

In a base system without the switch `\AllMotionTasks`, the movements for the following mechanical units are stopped:

- always the mechanical units in the main task, independent of which task executes the `StopMove` instruction.

In a `MultiMove` system without the switch `\AllMotionTasks`, the movements for the following mechanical units are stopped:

- the mechanical units in the motion task executing `StopMove`.
- the mechanical units in the motion task that are connected to the non-motion task executing `StopMove`. Besides that, if mechanical units are stopped in one connected motion task belonging to a coordinated synchronized task group then the mechanical units are stopped in all the cooperated tasks.

The `StopMove` state in the motion task generated from the motion task itself will automatically be reset when starting that task from the beginning.

The `StopMove` state in connected motion task, generated from some non-motion task, will automatically be reset:

- if normal non-motion task, at the start of that task from the beginning.
- if semi-static non-motion task, at power fail restart when the task is starting from the beginning.
- if static non-motion task, at installation start when the task is starting from the beginning.

More examples

More examples of the instruction `StopMove` are illustrated below.

Example 1

```
VAR intnum intnol;
...
PROC main()
...
CONNECT intnol WITH go_to_home_pos;
ISignalDI dil,1,intnol;
...

TRAP go_to_home_pos
VAR robtargt p10;
```

Continues on next page

1 Instructions

1.284 StopMove - Stops robot movement

RobotWare Base

Continued

```
StopMove;
StorePath;
p10:=CRobT(\Tool:=tool1 \WObj:=wobj0);
MoveL home,v500,fine,tool1;
WaitDI di1,0;
MoveL p10,v500,fine,tool1;
RestoPath;
StartMove;
ENDTRAP
```

When the input `di1` is set to 1 an interrupt is activated which in turn activates the interrupt routine `go_to_home_pos`. The current movement is stopped, and the robot moves instead to the `home` position. When `di1` is set to 0 the robot returns to the position at which the interrupt occurred and continues to move along the programmed path.

Example 2

```
VAR intnum intnol;
...
PROC main()
...
CONNECT intnol WITH go_to_home_pos;
ISignalDI di1,1,intnol;
...

TRAP go_to_home_pos ()
VAR robtargt p10;
StorePath;
p10:=CRobT(\Tool:=tool1 \WObj:=wobj0);
MoveL home,v500,fine,tool1;
WaitDI di1,0;
MoveL p10,v500,fine,tool1;
RestoPath;
StartMove;
ENDTRAP
```

Similar to the previous example but the robot does not move to the home position until the current movement instruction is finished.

`StorePath` is waiting for the robot movement to stop, and then does the movement to the home position.

Limitations

Only one of several non-motion tasks is allowed at the same time to do `StopMove` - `StartMove` sequence against some motion task.

Syntax

```
StopMove
['\Quick]
['\AllMotionTasks'];'
```

Continues on next page

Related information

For information about	See
Continuing a movement	StartMove - Restarts robot movement on page 791 StartMoveRetry - Restarts robot movement and execution on page 794
Store - restore path	StorePath - Stores the path when an interrupt occurs on page 826 RestoPath - Restores the path after an interrupt on page 618

1 Instructions

1.285 StopMoveReset - Reset the system stop move state *RobotWare Base*

1.285 StopMoveReset - Reset the system stop move state

Usage

`StopMoveReset` is used to reset the system stop move state without starting any movements.

Asynchronously raised movements errors, such as `ERR_PATH_STOP` or specific process error during the movements, can be handled in the `ERROR` handler. When such an error occurs the movements are stopped at once, and the system stop move flag is set for actual program tasks. This means that the movement is not restarted if doing any program start while program pointer is inside the `ERROR` handler.

Restart of the movements after such movement error will be done after one of these action:

- Execute `StartMove` or `StartMoveRetry`.
- Execute `StopMoveReset` and the movement will restart at the next program start.

Basic examples

The following example illustrates the instruction `StopMoveReset`:

Example 1

```
...
ArcL p101, v100, seam1, weld1, weave1, z10, gun1;
...
ERROR
  IF ERRNO=AW_WELD_ERR OR ERRNO=ERR_PATH_STOP THEN
    ! Execute something but without any restart of the movement
    ! ProgStop - ProgStart must be allowed
    ...
    ! No idea to try to recover from this error, so let the error
    ! stop the program
    ...
    ! Reset the move stop flag, so it's possible to manual restart
    ! the program and the movement after that the program has
    ! stopped
    StopMoveReset;
  ENDIF
ENDPROC
```

After that above `ERROR` handler has executed the `ENDPROC`, the program execution stops and the pointer is at the beginning of the `ArcL` instruction. Next program start restarts the program and movement from the position where the original movement error occurred.

Arguments

`StopMoveReset` [`\AllMotionTasks`]

[`\AllMotionTasks`]

Data type: switch

Continues on next page

Reset the system stop move state for all mechanical units in the system. The switch `[\AllMotionTasks]` can only be used from a non-motion program task.

Program execution

To reset a MultiMove application in synchronized coordinated mode, `StopMoveReset` must be executed in all motion tasks that are involved in coordination.

With the switch `\AllMotionTasks` (only allowed from non-motion program task) the reset is done for all all mechanical units in the system.

In a base system without the switch `\AllMotionTasks`, the reset is always done for the main task, independent of which task that executes the `StopMoveReset` instruction.

For base system it is possible to use `StopMoveReset` in the following type of program tasks:

- main task `T_ROB1` to reset the stop move state in that task.
- any other task to reset the stop move state in the main task.

For MultiMove system it is possible to use this instruction in the following type of program tasks:

- motion task, to reset the stop move state in that task.
- non motion task, to reset the stop move state in the connected motion task. Besides that, if the reset of the stop move state in one connected motion task belonging to a coordinated synchronized task group, the stop move state is reset in all the cooperating tasks.

Syntax

```
StopMoveReset
  ['\AllMotionTasks'];'
```

Related information

For information about	See
Stop the movement	StopMove - Stops robot movement on page 820
Continuing a movement	StartMove - Restarts robot movement on page 791 StartMoveRetry - Restarts robot movement and execution on page 794
Store - restore path	StorePath - Stores the path when an interrupt occurs on page 826 RestoPath - Restores the path after an interrupt on page 618

1 Instructions

1.286 StorePath - Stores the path when an interrupt occurs
RobotWare Base

1.286 StorePath - Stores the path when an interrupt occurs

Usage

`StorePath` is used to store the movement path being executed, e.g. when an error or interrupt occurs. The error handler or a trap routine can then start a new temporary movement and finally restart the original movement that was stored earlier.

For example, this instruction can be used to go to a service position or to clean the gun when an error occurs.

This instruction can only be used in the main task `T_ROB1` or, if in a MultiMove system, in Motion tasks.

Basic examples

The following example illustrates the instruction `StorePath`:

See also [More examples on page 827](#).

Example 1

```
StorePath;
```

The current movement path is stored for later use. Set the system to independent movement mode.

Example 2

```
StorePath \KeepSync;
```

The current movement path is stored for later use. Keep synchronized movement mode.

Arguments

```
StorePath [\KeepSync]
```

[`\KeepSync`]

Keep Synchronization

Data type: switch

Keeps synchronized movement mode after the `StorePath \KeepSync`. The `KeepSync` switch can only be used if the system is in synchronized movement mode before the `StorePath \KeepSync` call.

Without the optional parameter `\KeepSync`, in a MultiMove coordinated synchronized system, the system is set to independent-semicoordinated movement mode. After execution of `StorePath` in all involved tasks, the system is in semicoordinated mode if further on use of coordinated work object. Otherwise it is in independent mode. If in semicoordinated mode it is recommended to always start with a movement in the mechanical unit that controls the user frame before `WaitSyncTask` in all involved tasks.

Continues on next page

Program execution

The current movement path of the robot and external axes are saved. After this, another movement can be started in a trap routine or in an error handler. When the reason for the error or interrupt has been rectified then the saved movement path can be restarted.

More examples

More examples of how to use the instruction `StorePath` are illustrated below.

Example 1

```
TRAP machine_ready
  VAR robtarget p1;
  StorePath;
  p1 := CRobT();
  MoveL p100, v100, fine, tool1;
  ...
  MoveL p1, v100, fine, tool1;
  RestoPath;
  StartMove;
ENDTRAP
```

When an interrupt occurs that activates the trap routine `machine_ready`, the movement path which the robot is executing at the time is stopped at the end of the instruction (`ToPoint`) and stored. After this the robot remedies the interrupt by, for example, replacing a part in the machine. Then the normal movement is restarted.

Limitations

Only the movement path data is stored with the instruction `StorePath`.

If the user wants to order movements on the new path level then the actual stop position must be stored directly after `StorePath` and before `RestoPath` makes a movement to the stored stop position on the path.

Only one movement path can be stored at a time.

Syntax

```
StorePath
  ['\KeepSync'];'
```

Related information

For information about	See
Restoring a path	RestoPath - Restores the path after an interrupt on page 618
More examples	RestoPath - Restores the path after an interrupt on page 618 PathRecStart - Start the path recorder on page 531 SyncMoveResume - Set synchronized coordinated movements on page 848 SyncMoveSuspend - Set independent-semicoordinated movements on page 850

1 Instructions

1.287 STTune - Tuning Servo Tool *Servo Tool Control*

1.287 STTune - Tuning Servo Tool

Usage

STTune is used to tune/change a servo tool parameter. The parameter is changed temporarily from the original value, which is set up in the system parameters. The new tune value will be active immediately after executing the instruction.

STTune is useful in tuning procedures. A tuning procedure is typically used to find an optimal value for a parameter. An experiment (i.e. a program execution with a servo tool movement) is repeated when using different parameter tune values.

STTune shall not be used during calibration or tool closure.

Description

RampTorqRefOpen

Tunes the system parameter Ramp when decrease force, which decides how fast force is released while opening the tool. The unit is Nm/s and a typical value 200.

Corresponding system parameter: topic *Motion*, type *Force master*, parameter ramp_torque_ref_opening.

RampTorqRefClose

Tunes the system parameter Ramp when increase force, which decides how fast force is built up while opening the tool. The unit is Nm/s and a typical value 80.

Corresponding system parameter: topic *Motion*, type *Force master*, parameter ramp_torque_ref_closing.

KV

Tunes the system parameter KV, which is used for speed limitation. The unit is Nms/rad and a typical value 1. For more details, see the external axis documentation.

Corresponding system parameter: topic *Motion*, type *Force master*, parameter KV.

SpeedLimit

Tunes the system parameter Speed limit, which is used for speed limitation. The unit is rad/s (motor speed) and a typical value 60. For more details, see the external axis documentation.

Corresponding system parameter: topic *Motion*, type *Force master*, parameter speed_limit.

CollAlarmTorq

Tunes the system parameter Collision alarm torque, which is used for the automatic calibration of new tips. The unit is Nm (motor torque) and a typical value 1. For more details, see the external axis documentation.

Corresponding system parameter: topic *Motion*, type *Force master*, parameter alarm_torque.

Continues on next page

CollContactPos

Tunes the system parameter `Collision delta pos`, which is used for automatic calibration of new tips. The unit is m and a typical value 0,002. For more details, see the external axis documentation.

Corresponding system parameter: topic *Motion*, type *Force master*, parameter `distance_to_contact_position`.

CollisionSpeed

Tunes the system parameter `Collision speed`, which is used for automatic calibration of new tips. The unit is m/s and a typical value 0,02. For more details, see the external axis documentation.

Corresponding system parameter: topic *Motion*, type *Force master*, parameter `col_speed`.

CloseTimeAdjust

Constant time adjustment (s), positive or negative, of the moment when the tool tips reaches contact during a tool closure. May be used to delay the closing slightly when the synchronized pre-closing is used for welding.

Corresponding system parameter: topic *Motion*, type *SG process*, parameter `min_close_time_adjust`.

ForceReadyDelayT

Constant time delay (s) before sending the weld ready signal after reaching the programmed force.

Corresponding system parameter: topic *Motion*, type *SG process*, parameter `pre_sync_delay_time`.

PostSyncTime

Release time anticipation (s) of the next robot movement after a weld. This tune type can be tuned to synchronize the gun opening with the next robot movement. The synchronization may fail if the parameters is set too high.

Corresponding system parameter: topic *Motion*, type *SG process*, parameter `post_sync_time`.

CalibTime

The wait time (s) during a calibration before the positional tool tip correction is done. For best results do not use too low a value like 0.5 s.

Corresponding system parameter: topic *Motion*, type *SG process*, parameter `calib_time`.

CalibForceLow

The minimum tip force (N) used during a TipWear calibration. For best result of the thickness detection it is recommended to use the minimum programmed weld force.

Corresponding system parameter: topic *Motion*, type *SG process*, parameter `calib_force_low`.

Continues on next page

1 Instructions

1.287 STTune - Tuning Servo Tool

Servo Tool Control

Continued

CalibForceHigh

The maximum tip force (N) used during a TipWear calibration. For best result of the thickness detection it is recommended to use the max programmed weld force. Corresponding system parameter: topic *Motion*, type *SG process*, parameter `calib_force_high`.

Basic examples

The following example illustrates the instruction `STTune`:

Example 1

```
STTune SEOLO_RG, 0.050, CloseTimeAdjust;
```

The servo tool parameter `CloseTimeAdjust` is temporarily set to 0.050 seconds.

Arguments

```
STTune MecUnit TuneValue Type
```

MecUnit

Data type: `mecunit`

The name of the mechanical unit.

TuneValue

Data type: `num`

New tuning value.

Type

Data type: `tunegtype`

Parameter type. Servo tool parameters available for tuning are `RampTorqRefOpen`, `RampTorqRefClose`, `KV`, `SpeedLimit`, `CollAlarmTorq`, `CollContactPos`, `CollisionSpeed`, `CloseTimeAdjust`, `ForceReadyDelayT`, `PostSyncTime`, `CalibTime`, `CalibForceLow`, `CalibForceHigh`. These types are predefined in the system parameters and defines the original values.

Program execution

The specified tuning type and tuning value are activated for the specified mechanical unit. This value is applicable for all movements until a new value is programmed for the current mechanical unit or until the tuning types and values are reset using the instruction `STTuneReset`.

The original tune values may be permanently changed in the system parameters.

The default servo tool tuning values are automatically set

- by executing instruction `STTuneReset`.
- at a **Restart**.

Continues on next page

Error handling

The following recoverable errors are generated and can be handled in an error handler. The system variable `ERRNO` will be set to:

Name	Cause of error
ERR_NO_SGUN	The specified servo tool name is not a configured servo tool.

Syntax

```
STTune
  [ MecUnit ':= ' ] < variable (VAR) of mecunit > ','
  [ TuneValue' := ' ] < expression (IN) of num > ','
  [ 'Type ':='] < expression (IN) of tunegtype > ]';
```

Related information

For information about	See
Restore of servo tool parameters	TuneReset - Resetting servo tuning on page 984
Tuning of servo tool	<i>Application manual - Additional axes and standalone controller</i>

1 Instructions

1.288 STTuneReset - Resetting Servo tool tuning *Servo Tool Control*

1.288 STTuneReset - Resetting Servo tool tuning

Usage

STTuneReset is used to restore original values of servo tool parameters if they have been changed by the STTune instruction.

Basic examples

The following example illustrates the instruction STTuneReset:

Example 1

```
STTuneReset SEOLO_RG;
```

Restore *original values of servo tool parameters* for the mechanical unit SEOLO_RG.

Arguments

```
STTuneReset MecUnit
```

MecUnit

Data type: mecunit

The name of the mechanical unit.

Program execution

The original servo tool parameters are restored.

This is also achieved at a **Restart**.

Error handling

The following recoverable errors are generated and can be handled in an error handler. The system variable ERRNO will be set to:

Name	Cause of error
ERR_NO_SGUN	The specified servo tool name is not a configured servo tool.

Syntax

```
STTuneReset  
[ MecUnit ':= ' ] < variable (VAR) of mecunit > ','
```

Related information

For information about	See
Tuning of servo tool parameters	STTune - Tuning Servo Tool on page 828
Tuning of servo tool parameters	<i>Application manual - Additional axes and standalone controller</i>

1.289 SupSyncSensorOff - Stop synchronized sensor supervision

Machine Synchronization

1.289 SupSyncSensorOff - Stop synchronized sensor supervision

Usage

`SupSyncSensorOff` is used to stop supervision of the robot movement and synchronized sensor movement.

Basic example

Basic example of the instruction `SupSyncSensorOff` is illustrated below.

Example

```
SupSyncSensorOff SSYNCl;
```

The sensor is no longer supervised.

Arguments

```
SupSyncSensorOff MechUnit
```

MechUnit

Mechanical unit

Data type: `mecunit`

The name of the mechanical unit.

Syntax

```
SupSyncSensorOff
  [ MechUnit ':' ] < variable (VAR) of mecunit > ';' ;
```

Related information

For information about	See
Start synchronized sensor supervision	SupSyncSensorOn - Start synchronized sensor supervision on page 834
Sync to sensor	SyncToSensor - Sync to sensor on page 854
<i>Machine Synchronization</i>	<i>Application manual - Controller software IRC5</i>

1 Instructions

1.290 SupSyncSensorOn - Start synchronized sensor supervision

Machine Synchronization

1.290 SupSyncSensorOn - Start synchronized sensor supervision

Usage

`SupSyncSensorOn` is used to start the supervision between robot movement and a synchronized sensor movement.

Basic example

Basic example of the instruction `SupSyncSensorOn` is illustrated below.

Example

```
SupSyncSensorOn Ssync1, 150, 100, 50
```

The mechanical unit `Ssync1` is supervised when the sensor is positioned between 50 and 150. The supervision is terminated if the distance between the robot and sensor is smaller than 100.

Arguments

```
SupSyncSensorOn MechUnit MaxSyncSup SafetyDist MinSyncSup  
[\SafetyDelay]
```

MechUnit

Mechanical unit

Data type: mecunit

The name of the mechanical unit.

MaxSyncSup

Maximal Synchronized supervised position

Data type: num

The robot will supervise the sensor until the sensor passes the max sync position. When the point is passed the supervision is stopped. The unit is mm.

SafetyDist

Safety distance

Data type: num

`Safetydist` is the limit of the difference between expected machine position and the real machine position. It must be negative, i.e. the model should always be moving in advance of the real machine. In the case of decreasing machine positions the limit must be negative corresponding to maximum negative position difference (and minimum advance distance). In the case of increasing machine positions the limit must be positive corresponding to minimum positive position difference (and minimum advance distance).

The robot will trigger an alarm if the distance between robot and sensor is smaller than the Safety distance. When the alarm is triggered supervision is stopped.

The unit is mm.

MinSyncSup

Minimal synchronized supervised position

Data type: num

Continues on next page

1.290 SupSyncSensorOn - Start synchronized sensor supervision

Machine Synchronization
Continued

The robot will start the supervision when the sensor is in the window defined from MinSyncSup position to MaxSyncSup position. The unit is mm.

[\SafetyDelay]

Safety delay

Data type: num

SafetyDelay is used to adjust the delay between the programmed position of the robot and the sensor supervised position. The unit is in seconds.

Limitations

If the SupSyncSensorOn is used before the instruction WaitSensor is finished the robot will stop.

Syntax

```
SupSyncSensorOn
  [ MechUnit ':= ' ] <variable (VAR) of mecunit> ', '
  [ MaxSyncSup ':= ' ] < expression (IN) of num > ', '
  [ SafetyDist ':= ' ] < expression (IN) of num > ', '
  [ MinSyncSup ':= ' ] < expression (IN) of num >
  [ \SafetyDelay ':= ' ] < expression (IN) of num > ';'
```

Related information

For information about	See
Stop synchronized sensor supervision	SupSyncSensorOff - Stop synchronized sensor supervision on page 833
Sync to sensor	SyncToSensor - Sync to sensor on page 854
<i>Machine Synchronization</i>	<i>Application manual - Controller software IRC5</i>

1 Instructions

1.291 SyncMoveOff - End coordinated synchronized movements *RW-MRS Synchronized*

1.291 SyncMoveOff - End coordinated synchronized movements

Usage

`SyncMoveOff` is used to end a sequence of synchronized movements and, in most cases, coordinated movements. First, all involved program tasks will wait to synchronize in a stop point, and then the motion planners for the involved program tasks are set to independent mode.

The instruction `SyncMoveOff` can only be used in a *MultiMove* system with option *Coordinated Robots* and only in program tasks defined as `Motion Task`.



WARNING

To reach safe synchronization functionality every meeting point (parameter `SyncID`) must have a unique name. The name of the meeting point must also be the same for all the program tasks that should meet.

Basic examples

The following example illustrates the instruction `SyncMoveOff`:

See also [More examples on page 838](#).

Example 1

```
!Program example in task T_ROB1

PERS tasks task_list{2} := [ ["T_ROB1"], ["T_ROB2"] ];
VAR syncident sync1;
VAR syncident sync2;

...
SyncMoveOn sync1, task_list;
...
SyncMoveOff sync2;
...

!Program example in task T_ROB2

PERS tasks task_list{2} := [ ["T_ROB1"], ["T_ROB2"] ];
VAR syncident sync1;
VAR syncident sync2;

...
SyncMoveOn sync1, task_list;
...
SyncMoveOff sync2;
...
```

The program task that first reaches `SyncMoveOff` with identity `sync2` waits until the other tasks reach `SyncMoveOff` with the same identity `sync2`. At that synchronization point `sync2`, the motion planners for the involved program tasks

Continues on next page

1.291 SyncMoveOff - End coordinated synchronized movements

RW-MRS Synchronized
Continued

are set to independent mode. After that, both task T_ROB1 and T_ROB2 continue their execution.

Arguments

SyncMoveOff SyncID [`\TimeOut`]

SyncID

Synchronization Identity

Data type: syncident

Variables that specify the name of the unsynchronization (meeting) point. Data type `syncident` is a non-value type. It is only used as an identifier for naming the unsynchronization point.

The variable must be defined and have an equal name in all cooperated program tasks. It is recommended to always define the variable global in each task (`VAR syncident ...`).

[`\TimeOut`]

Data type: num

The max. time to wait for the other program tasks to reach the unsynchronization point. The time-out is defined in seconds (resolution 0,001s).

If this time runs out before all program tasks have reached the unsynchronization point then the error handler will be called, if there is one, with the error code `ERR_SYNCMOVEOFF`. If there is no error handler then the execution will be stopped. If this argument is omitted then the program task will wait forever.

Program execution

The program task that first reaches `SyncMoveOff` waits until all other specified tasks reach `SyncMoveOff` with the same `SyncID` identity. At that `SyncID` unsynchronization point the motion planner for the involved program tasks is set to independent mode. After that, involved program tasks continue their execution. The motion planner for the involved program tasks are set to unsynchronized mode. This means the following:

- All RAPID program tasks and all movements from these tasks are working independently of each other again.
- Any move instruction must not be marked with any ID number. See instruction `MoveL`.

It is possible to exclude program tasks for testing purpose from FlexPendant - Task Selection Panel. The instructions `SyncMoveOn` and `SyncMoveOff` will still work with the reduced number of program tasks, even for only one program task.

Error handling

The following recoverable errors are generated and can be handled in an error handler. The system variable `ERRNO` will be set to:

Name	Cause of error
<code>ERR_SYNCMOVEOFF</code>	Time-out from <code>SyncMoveOff</code> .

Continues on next page

1 Instructions

1.291 SyncMoveOff - End coordinated synchronized movements

RW-MRS Synchronized

Continued

More examples

More examples of how to use the instruction `SyncMoveOff` are illustrated below.

Example of simple synchronized movement

```
!Program example in task T_ROB1
PERS tasks task_list{2} := [ ["T_ROB1"], ["T_ROB2"] ];
VAR syncident sync1;
VAR syncident sync2;
VAR syncident sync3;

PROC main()
...
MoveL p_zone, vmax, z50, tcp1;
WaitSyncTask sync1, task_list;
MoveL p_fine, v1000, fine, tcp1;
syncmove;
...
ENDPROC

PROC syncmove()
SyncMoveOn sync2, task_list;
MoveL * \ID:=10, v100, z10, tcp1 \WObj:= rob2_obj;
MoveL * \ID:=20, v100, fine, tcp1 \WObj:= rob2_obj;
SyncMoveOff sync3;
UNDO
    SyncMoveUndo;
ENDPROC

!Program example in task T_ROB2
PERS tasks task_list{2} := [ ["T_ROB1"], ["T_ROB2"] ];
VAR syncident sync1;
VAR syncident sync2;
VAR syncident sync3;

PROC main()
...
MoveL p_zone, vmax, z50, obj2;
WaitSyncTask sync1, task_list;
MoveL p_fine, v1000, fine, obj2;
syncmove;
...
ENDPROC

PROC syncmove()
SyncMoveOn sync2, task_list;
MoveL * \ID:=10, v100, z10, obj2;
MoveL * \ID:=20, v100, fine, obj2 ;
SyncMoveOff sync3;
UNDO
    SyncMoveUndo;
ENDPROC
```

Continues on next page

1.291 SyncMoveOff - End coordinated synchronized movements

*RW-MRS Synchronized**Continued*

First program tasks T_ROB1 and T_ROB2 are waiting at WaitSyncTask with identity sync1 for each other, programmed with corner path for the preceding movements for saving cycle time.

Then the program tasks are waiting at SyncMoveOn with identity sync2 for each other, programmed with a necessary stop point for the preceding movements. After that, the motion planner for the involved program tasks is set to synchronized mode.

After that, T_ROB2 is moving the obj2 to ID point 10 and 20 in world coordinate system while T_ROB1 is moving the tcp1 to ID point 10 and 20 on the moving object obj2.

Then the program tasks are waiting at SyncMoveOff with identity sync3 for each other, programmed with a necessary stop point for the preceding movements. After that, the motion planner for the involved program tasks is set to independent mode.

Example with error recovery

```
!Program example with use of time-out function
VAR syncident sync3;

...
SyncMoveOff sync3 \TimeOut := 60;
...
ERROR
  IF ERRNO = ERR_SYNCMOVEOFF THEN
    RETRY;
  ENDIF
```

The program task waits for an instruction SyncMoveOff and for some other program task to reach the same synchronization point sync3. After waiting 60 seconds, the error handler is called with ERRNO equal to ERR_SYNCMOVEOFF. Then the instruction SyncMoveOff is called again for an additional wait of 60 seconds.

Example with semi coordinated and coordinated movement

```
!Example with semicoordinated and synchronized movement
!Program example in task T_ROB1
PERS tasks task_list{2} := [ ["T_ROB1"], ["T_ROB2"] ];
PERS wobjdata rob2_obj:= [FALSE,FALSE,"ROB_2",
  [[0,0,0],[1,0,0,0]],[[155.241,-51.5938,57.6297],
  [0.493981,0.506191,-0.501597,0.49815]]];
VAR syncident sync0;
VAR syncident sync1;
VAR syncident sync2;
VAR syncident sync3;
VAR syncident sync4;

PROC main()
  ...
  WaitSyncTask sync0, task_list;
  MoveL pl_90, v100, fine, tcp1 \WObj:= rob2_obj;
  WaitSyncTask sync1, task_list;
```

Continues on next page

1 Instructions

1.291 SyncMoveOff - End coordinated synchronized movements

RW-MRS Synchronized

Continued

```
SyncMoveOn sync2, task_list;
MoveL p1_100 \ID:=10, v100, fine, tcp1 \WObj:= rob2_obj;
SyncMoveOff sync3;
!Wait until the movement has been finished in T_ROB2
WaitSyncTask sync3, task_list;
!Now a semicoordinated movement can be performed
MoveL p1_120, v100, z10, tcp1 \WObj:= rob2_obj;
MoveL p1_130, v100, fine, tcp1 \WObj:= rob2_obj;
WaitSyncTask sync4, task_list;
...
ENDPROC
```

```
!Program example in task T_ROB2
PERS tasks task_list{2} := [ ["T_ROB1"], ["T_ROB2"] ];
VAR syncident sync0;
VAR syncident sync1;
VAR syncident sync2;
VAR syncident sync3;
VAR syncident sync4;

PROC main()
...
MoveL p_fine, v1000, fine, tcp2;
WaitSyncTask sync0, task_list;
!Wait until the movement in T_ROB1 task is finished
WaitSyncTask sync1, task_list;
SyncMoveOn sync2, task_list;
MoveL p2_100 \ID:=10, v100, fine, tcp2;
SyncMoveOff sync3;
!The path has been removed at SyncMoveOff
!Perform a movement to wanted position for the object to
!make the position available for other tasks
MoveL p2_100, v100, fine, tcp2;
WaitSyncTask sync3, task_list;
WaitSyncTask sync4, task_list;
MoveL p2_110, v100, z10, tcp2;
...
ENDPROC
```

When switching between semicoordinated to synchronized movement, a `WaitSyncTask` is needed (when using identity `sync1`).

When switching between synchronized to semicoordinated movement, the task that move the work object (`rob2_obj`) needs to move to the desired position. After that a `WaitSyncTask` is needed (identity `sync3`) before the semicoordinated movement can be performed.

Limitations

The `SyncMoveOff` instruction can only be executed if all involved robots stand still in a stop point.

Continues on next page

1.291 SyncMoveOff - End coordinated synchronized movements

RW-MRS Synchronized

Continued

If this instruction is preceded by a move instruction then that move instruction must be programmed with a stop point (zonedata *fine*), not a fly-by point.

Otherwise restart after power failure will not be possible.

`SyncMoveOff` cannot be executed in a RAPID routine connected to any of the following special system events: `PowerOn`, `Stop`, `QStop`, `Restart`, `Reset`, or `Step`.

Syntax

```
SyncMoveOff
  [ SyncID ':' := ' ] < variable (VAR) of syncident >
  [ '\TimeOut' := ' < expression (IN) of num > ] ';' ;'
```

Related information

For information about	See
Specify cooperated program tasks	tasks - RAPID program tasks on page 1772
Identity for synchronization point	syncident - Identity for synchronization point on page 1768
Start coordinated synchronized movements	SyncMoveOn - Start coordinated synchronized movements on page 842
Set independent movements	SyncMoveUndo - Set independent movements on page 852
Test if in synchronized mode	IsSyncMoveOn - Test if in synchronized movement mode on page 1355
MultiMove system with option Coordinated robots	Application manual - MultiMove

1 Instructions

1.292 SyncMoveOn - Start coordinated synchronized movements *RW-MRS Synchronized*

1.292 SyncMoveOn - Start coordinated synchronized movements

Usage

`SyncMoveOn` is used to start a sequence of synchronized movements and in most cases, coordinated movements. First, all involved program tasks will wait to synchronize in a stop point and then the motion planner for the involved program tasks is set to synchronized mode.

The instruction `SyncMoveOn` can only be used in a *MultiMove* system with option *Coordinated Robots* and only in program tasks defined as `Motion Task`.



WARNING

To reach safe synchronization functionality every meeting point (parameter `SyncID`) must have a unique name. The name of the meeting point must also be the same for all the program tasks that should meet in the meeting point.

Basic examples

The following example illustrates the instruction `SyncMoveOn`:

See also [More examples on page 844](#).

Example 1

```
!Program example in task T_ROB1

PERS tasks task_list{2} := [ ["T_ROB1"], ["T_ROB2"] ];
VAR syncident sync1;
VAR syncident sync2;

...
SyncMoveOn sync1, task_list;
...
SyncMoveOff sync2;
...

!Program example in task T_ROB2

PERS tasks task_list{2} := [ ["T_ROB1"], ["T_ROB2"] ];
VAR syncident sync1;
VAR syncident sync2;

...
SyncMoveOn sync1, task_list;
...
SyncMoveOff sync2;
...
```

The program task that first reaches `SyncMoveOn` with identity `sync1` waits until the other task reaches its `SyncMoveOn` with the same identity `sync1`. At that synchronization point, `sync1`, the motion planner for the involved program tasks is set to synchronized mode. After that, both task `T_ROB1` and `T_ROB2` continue

Continues on next page

1.292 SyncMoveOn - Start coordinated synchronized movements

RW-MRS Synchronized

Continued

their execution, synchronized until they reach `SyncMoveOff` with the same identity `sync2`.

Arguments

`SyncMoveOn SyncID TaskList [\TimeOut]`

SyncID

Synchronization Identity

Data type: `syncident`

Variable that specifies the name of the synchronization (meeting) point. Data type `syncident` is a non-value type that is only used as an identifier for naming the synchronization point.

The variable must be defined and have an equal name in all cooperated program tasks. It is recommended to always define the variable global in each task (`VAR syncident ...`).

TaskList

Data type: `tasks`

Persistent variable that in a task list (array) specifies the name (string) of the program tasks that should meet in the synchronization point with name according argument `SyncID`.

The persistent variable must be defined and have equal name and equal contents in all cooperated program tasks. It is recommended to always define the variable global in the system (`PERS tasks ...`).

[\TimeOut]

Data type: `num`

The max. time to wait for the other program tasks to reach the synchronization point. The time-out is defined in seconds (resolution 0.001s).

If this time runs out before all program tasks have reached the synchronization point then the error handler will be called, if there is one, with the error code `ERR_SYNCMOVEON`. If there is no error handler then the execution will be stopped.

If this argument is omitted then the program task will wait for ever.

Program execution

The program task that first reaches `SyncMoveOn` waits until all other specified tasks reach their `SyncMoveOn` with the same `SyncID` identity. At that `SyncID` synchronization point the motion planner for the involved program tasks is set to synchronized mode. After that, involved program tasks continue their execution.

The motion planner for the involved program tasks is set to synchronized mode. This means the following:

- Each movement instruction in any program task in the `TaskList` is working synchronous with movement instructions in other program tasks in the `TaskList`.
- All cooperated movement instructions are planned and interpolated in the same Motion Planner.

Continues on next page

1 Instructions

1.292 SyncMoveOn - Start coordinated synchronized movements

RW-MRS Synchronized

Continued

- All movements start and end at the same time. The movement that takes the longest time will be the speed master with reduced speed in relation to the work object for the other movements.
- All cooperated move instruction must be marked with the same ID number. See instruction `MoveL`.

It is possible to exclude program tasks for testing purpose from FlexPendant - Task Selection Panel. The instruction `SyncMoveOn` will still work with the reduced number of program tasks even for only one program task.

Error handling

The following recoverable errors are generated and can be handled in an error handler. The system variable `ERRNO` will be set to:

Name	Cause of error
<code>ERR_SYNCMOVEON</code>	Time-out from <code>SyncMoveOn</code> .

More examples

More examples of how to use the instruction `SyncMoveOn` are illustrated below.

Example 1

```
!Program example in task T_ROB1
PERS tasks task_list{2} := [{"T_ROB1"}, {"T_ROB2"}];
VAR syncident sync1;
VAR syncident sync2;
VAR syncident sync3;

PROC main()
  ...
  MoveL p_zone, vmax, z50, tcp1;
  WaitSyncTask sync1, task_list;
  MoveL p_fine, v1000, fine, tcp1;
  syncmove;
  ...
ENDPROC

PROC syncmove()
  SyncMoveOn sync2, task_list;
  MoveL * \ID:=10, v100, z10, tcp1 \WOBJ:= rob2_obj;
  MoveL * \ID:=20, v100, fine, tcp1 \WOBJ:= rob2_obj;
  SyncMoveOff sync3;
  UNDO
  SyncMoveUndo;
ENDPROC

!Program example in task T_ROB2
PERS tasks task_list{2} := [{"T_ROB1"}, {"T_ROB2"}];
VAR syncident sync1;
VAR syncident sync2;
VAR syncident sync3;
```

Continues on next page

1.292 SyncMoveOn - Start coordinated synchronized movements

*RW-MRS Synchronized**Continued*

```

PROC main()
    ...
    MoveL p_zone, vmax, z50, obj2;
    WaitSyncTask sync1, task_list;
    MoveL p_fine, v1000, fine, obj2;
    syncmove;
    ...
ENDPROC

PROC syncmove()
    SyncMoveOn sync2, task_list;
    MoveL * \ID:=10, v100, z10, obj2;
    MoveL * \ID:=20, v100, fine, obj2;
    SyncMoveOff sync3;
    UNDO
        SyncMoveUndo;
    ENDPROC

```

First, program tasks T_ROB1 and T_ROB2 are waiting at WaitSyncTask with identity sync1 for each other. They are programmed with corner path for the preceding movements for saving cycle time.

Then the program tasks are waiting at SyncMoveOn with identity sync2 for each other. They are programmed with a necessary stop point for the preceding movements. After that the motion planner for the involved program tasks is set to synchronized mode.

After that, T_ROB2 is moving the obj2 to ID point 10 and 20 in world coordinate system while T_ROB1 is moving the tcp1 to ID point 10 and 20 on the moving object obj2.

Example 2

```

!Program example with use of time-out function
VAR syncident sync3;

...
SyncMoveOn sync3, task_list \TimeOut :=60;
...
ERROR
    IF ERRNO = ERR_SYNCMOVEON THEN
        RETRY;
    ENDIF

```

The program task waits for instruction SyncMoveOn for the program task T_ROB2 to reach the same synchronization point sync3. After waiting 60 seconds, the error handler is called with ERRNO equal to ERR_SYNCMOVEON. Then the instruction SyncMoveOn is called again for an additional wait of 60 seconds.

Example 3- Program example with three tasks

```

!Program example in task T_ROB1
PERS tasks task_list1 {2} :=[["T_ROB1"], ["T_ROB2"]];
PERS tasks task_list2 {3} :=[["T_ROB1"], ["T_ROB2"], ["T_ROB3"]];
VAR syncident sync1;
...

```

Continues on next page

1 Instructions

1.292 SyncMoveOn - Start coordinated synchronized movements

RW-MRS Synchronized

Continued

```
VAR syncident sync5;

...
SyncMoveOn sync1, task_list1;
...
SyncMoveOff sync2;
WaitSyncTask sync3, task_list2;
SyncMoveOn sync4, task_list2;
...
SyncMoveOff sync5;
...

!Program example in task T_ROB2

PERS tasks task_list1 {2} := [{"T_ROB1"}, {"T_ROB2"}];
PERS tasks task_list2 {3} := [{"T_ROB1"}, {"T_ROB2"}, {"T_ROB3"}];
VAR syncident sync1;
...
VAR syncident sync5;

...
SyncMoveOn sync1, task_list1;
...
SyncMoveOff sync2;
WaitSyncTask sync3, task_list2;
SyncMoveOn sync4, task_list2;
...
SyncMoveOff sync5;
...

!Program example in task T_ROB3

PERS tasks task_list2 {3} := [{"T_ROB1"}, {"T_ROB2"}, {"T_ROB3"}];
VAR syncident sync3;
VAR syncident sync4;
VAR syncident sync5;

...
WaitSyncTask sync3, task_list2;
SyncMoveOn sync4, task_list2;
...
SyncMoveOff sync5;
...
```

In this example, at first, program task T_ROB1 and T_ROB2 are moving synchronized and T_ROB3 is moving independent. Further on in the program all three tasks are moving synchronized. To prevent the instruction of SyncMoveOn to be executed in T_ROB3 before the first synchronization of T_ROB1 and T_ROB2 have ended, the instruction WaitSyncTask is used.

Continues on next page

Limitations

The `SyncMoveOn` instruction can only be executed if all involved robots stand still in a stop point.

Only one coordinated synchronized movement group can be active at the same time.

If this instruction is preceded by a move instruction then that move instruction must be programmed with a stop point (zonedata `fine`), not a fly-by point.

Otherwise restart after power failure will not be possible.

`SyncMoveOn` cannot be executed in a RAPID routine connected to any of the following special system events: `PowerOn`, `Stop`, `QStop`, `Restart`, `Reset`, or `Step`.

Syntax

```
SyncMoveOn
  [ SyncID ':= ' ] < variable (VAR) of syncident > ', '
  [ TaskList ':= ' ] < persistent array {*} (PERS) of tasks > ', '
  [ '\ ' Timeout ':= ' < expression (IN) of num > ] ';'

```

Related information

For information about	See
Specify cooperated program tasks	tasks - RAPID program tasks on page 1772
Identity for synchronization point	syncident - Identity for synchronization point on page 1768
End coordinated synchronized movements	SyncMoveOff - End coordinated synchronized movements on page 836
Set independent movements	SyncMoveUndo - Set independent movements on page 852
Test if in synchronized mode	IsSyncMoveOn - Test if in synchronized movement mode on page 1355
MultiMove system with option Coordinated Robots	Application manual - MultiMove
Wait for synchronized tasks	WaitSyncTask - Wait at synchronization point for other program tasks on page 1070

1 Instructions

1.293 SyncMoveResume - Set synchronized coordinated movements

RW-MRS Synchronized

1.293 SyncMoveResume - Set synchronized coordinated movements

Usage

`SyncMoveResume` is used to go back to synchronized movements from independent movement mode. The instruction can only be used on `StorePath` level, e.g. after a `StorePath \KeepSync` has been executed and the system is in independent motion mode after `SyncMoveSuspend` has been executed. To be able to use the instruction the system must have been in synchronized motion mode before executing the `StorePath` and `SyncMoveSuspend` instruction.

The instruction `SyncMoveResume` can only be used in a *MultiMove* system with options *Coordinated Robots* and *Path Recovery* and only in program tasks defined as *Motion Task*.

Basic examples

The following example illustrates the instruction `SyncMoveResume`:

Example 1

```
ERROR
StorePath \KeepSync;
! Save position
p11 := CRobT(\Tool:=tool2);
! Move in synchronized motion mode
MoveL p12\ID:=111, v50, fine, tool2;
SyncMoveSuspend;
! Move in independent mode somewhere, e.g. to a cleaning station
p13 := CRobT();
MoveL p14, v100, fine, tool2;
! Do something at cleaning station
MoveL p13, v100, fine, tool2;
SyncMoveResume;
! Move in synchronized motion mode back to start position p11
MoveL p11\ID:=112, v50, fine, tool2;
RestoPath;
StartMove;
RETRY;
```

Some kind of recoverable error occurs. The system is kept in synchronized mode, and a synchronized movement is done to a point, e.g. moving backwards on path. After that, an independent movement is done to a cleaning station. Then the robot is moved back to the point where the error occurred and the program continues where it was interrupted by the error.

Program execution

`SyncMoveResume` forces resume of synchronized mode when system is in independent movement mode on `StorePath` level.

`SyncMoveResume` is required in all tasks that were executing in synchronized movement before entering independent movement mode. If one Motion task executes a `SyncMoveResume` then that task will wait until all tasks that earlier were

Continues on next page

1.293 SyncMoveResume - Set synchronized coordinated movements

*RW-MRS Synchronized
Continued*

in synchronized movement mode execute a `SyncMoveResume` instruction. After that, involved program tasks continue their execution.

Limitations

The `SyncMoveResume` can only be used to go back to synchronized movement mode and can only be used on `StorePath` level.

If this instruction is preceded by a move instruction then that move instruction must be programmed with a stop point (zonedata `fine`), not a fly-by point. Otherwise restart after power failure will not be possible.

`SyncMoveResume` cannot be executed in a RAPID routine connected to any of the following special system events: `PowerOn`, `Stop`, `QStop`, `Restart`, `Reset`, or `Step`.

Syntax

```
SyncMoveResume ' ; '
```

Related information

For information about	See
Specify cooperated program tasks	tasks - RAPID program tasks on page 1772
Start coordinated synchronized movements	SyncMoveOn - Start coordinated synchronized movements on page 842
End coordinated synchronized movements	SyncMoveOff - End coordinated synchronized movements on page 836
Test if in synchronized mode	SyncMoveOn - Start coordinated synchronized movements on page 842
Stores the path	StorePath - Stores the path when an interrupt occurs on page 826
Restores the path	RestoPath - Restores the path after an interrupt on page 618
Suspends synchronized movements	SyncMoveSuspend - Set independent-semicoordinated movements on page 850

1 Instructions

1.294 SyncMoveSuspend - Set independent-semicoordinated movements *RW-MRS Synchronized*

1.294 SyncMoveSuspend - Set independent-semicoordinated movements

Usage

`SyncMoveSuspend` is used to suspend synchronized movements mode and set the system to independent-semicoordinated movement mode. The instruction can only be used on `StorePath` level, e.g. after a `StorePath` or `StorePath \KeepSync` has been executed and the system is in synchronized movement mode.

The instruction `SyncMoveSuspend` can only be used in a *MultiMove System* with options *Coordinated Robots* and *Path Recovery* and only in program tasks defined as *Motion Task*.

Basic examples

The following example illustrates the instruction `SyncMoveSuspend`:

Example 1

```
ERROR
  StorePath \KeepSync;
  ! Save position
  p11 := CRobT(\Tool:=tool2);
  ! Move in synchronized motion mode
  MoveL p12\ID:=111, v50, fine, tool2;
  SyncMoveSuspend;
  ! Move in independent mode somewhere, e.g. to a cleaning station
  p13 := CRobT();
  MoveL p14, v100, fine, tool2;
  ! Do something at cleaning station
  MoveL p13, v100, fine, tool2;
  SyncMoveResume;
  ! Move in synchronized motion mode back to start position p11
  MoveL p11\ID:=112, v50, fine, tool2;
  RestoPath;
  StartMove;
  RETRY;
```

Some kind of recoverable error occurs. The system is kept in synchronized mode, and a synchronized movement is done to a point, e.g. moving backwards on path. After that, an independent movement is done to a cleaning station. Then the robot is moved back to the point where the error occurred and the program continues where it was interrupted by the error.

Program execution

`SyncMoveSuspend` forces reset of synchronized movements and sets the system to independent-semicoordinated movement mode.

`SyncMoveSuspend` is required in all synchronized Motion tasks to set the system in independent-semicoordinated movement mode. If one Motion tasks executes a `SyncMoveSuspend` then that task waits until the other tasks have executed a `SyncMoveSuspend` instruction.

Continues on next page

1.294 SyncMoveSuspend - Set independent-semicoordinated movements

*RW-MRS Synchronized**Continued*

After execution of `SyncMoveSuspend` in all involved tasks, the system is in semicoordinated mode if it further uses a coordinated work object. Otherwise, it is in independent mode. If in semicoordinated mode, it is recommended to always start with a movement in the mechanical unit that controls the user frame before `WaitSyncTask` in all involved tasks.

Limitations

The `SyncMoveSuspend` instruction suspends synchronized mode only on `StorePath` level. After returning from `StorePath` level, the system is set to the mode that it was in before the `StorePath`.

If this instruction is preceded by a move instruction then that move instruction must be programmed with a stop point (zonedata `fine`), not a fly-by point. Otherwise restart after power failure will not be possible.

`SyncMoveSuspend` cannot be executed in a RAPID routine connected to any of the following special system events: `PowerOn`, `Stop`, `QStop`, `Restart`, `Reset`, or `Step`.

Syntax

```
SyncMoveSuspend ' ; '
```

Related information

For information about	See
Specify cooperated program tasks	tasks - RAPID program tasks on page 1772
Start coordinated synchronized movements	SyncMoveOn - Start coordinated synchronized movements on page 842
End coordinated synchronized movements	SyncMoveOff - End coordinated synchronized movements on page 836
Test if in synchronized mode	IsSyncMoveOn - Test if in synchronized movement mode on page 1355
Stores the path	StorePath - Stores the path when an interrupt occurs on page 826
Restores the path	RestoPath - Restores the path after an interrupt on page 618
Resume synchronized movements	SyncMoveResume - Set synchronized coordinated movements on page 848

1 Instructions

1.295 SyncMoveUndo - Set independent movements

RobotWare Base

1.295 SyncMoveUndo - Set independent movements

Usage

`SyncMoveUndo` is used to force a reset of synchronized coordinated movements and set the system to independent movement mode.

The instruction `SyncMoveUndo` can only be used in a *MultiMove* system with option *Coordinated Robots* and only in program tasks defined as `Motion Task`.

Basic examples

The following example illustrates the instruction `SyncMoveUndo`:

Example 1

Program example in task `T_ROB1`

```
PERS tasks task_list{2} := [ ["T_ROB1"], ["T_ROB2"] ];
VAR syncident sync1;
VAR syncident sync2;
VAR syncident sync3;
PROC main()

...
MoveL p_zone, vmax, z50, tcp1;
WaitSyncTask sync1, task_list;
MoveL p_fine, v1000, fine, tcp1;
syncmove;
...
ENDPROC

PROC syncmove()
SyncMoveOn sync2, task_list;
MoveL * \ID:=10, v100, z10, tcp1 \WOBJ:= rob2_obj;
MoveL * \ID:=20, v100, fine, tcp1 \WOBJ:= rob2_obj;
SyncMoveOff sync3;
UNDO
SyncMoveUndo;
ENDPROC
```

If the program is stopped while the execution is inside the procedure `syncmove` and the program pointer is moved out of the procedure `syncmove` then all instruction inside the `UNDO` handler is executed. In this example, the instruction `SyncMoveUndo` is executed and the system is set to independent movement mode.

Program execution

Force reset of synchronized coordinated movements and set the system to independent movement mode.

It is enough to execute `SyncMoveUndo` in one program task to set the whole system to the independent movement mode. The instruction can be executed several times without any error if the system is already in independent movement mode.

Continues on next page

The system is set to the default independent movement mode also

- when using the restart mode **Reset RAPID**
- when loading a new program or a new module
- when starting program execution from the beginning
- when moving the program pointer to `main`
- when moving the program pointer to a routine
- when moving the program pointer in such a way that the execution order is lost.

Syntax

```
SyncMoveUndo ';' ;'
```

Related information

For information about	See
Specify cooperated program tasks	tasks - RAPID program tasks on page 1772
Identity for synchronization point	syncident - Identity for synchronization point on page 1768
Start coordinated synchronized movements	SyncMoveOn - Start coordinated synchronized movements on page 842
End coordinated synchronized movements	SyncMoveOff - End coordinated synchronized movements on page 836
Test if in synchronized mode	IsSyncMoveOn - Test if in synchronized movement mode on page 1355

1 Instructions

1.296 SyncToSensor - Sync to sensor *Machine Synchronization*

1.296 SyncToSensor - Sync to sensor

Usage

`SyncToSensor` is used to start or stop synchronization of robot movement to sensor movement.

Basic examples

Basic examples of the instruction `SyncToSensor` are illustrated below.

Example 1

```
WaitSensor Ssync1;  
MoveL *, v1000, z10, tool, \WObj:=wobj0;  
SyncToSensor Ssync1\On;  
MoveL *, v1000, z20, tool, \WObj:=wobj0;  
MoveL *, v1000, z20, tool, \WObj:=wobj0;  
SyncToSensor Ssync1\Off;
```

Arguments

`SyncToSensor MechUnit [\MaxSync] [\On] | [\Off]`

MechUnit

Mechanical Unit

Data type: mecunit

The moving mechanical unit to which the robot position in the instruction is related.

[\MaxSync]

Data type: num

The robot will move synchronized with sensor until the sensor passes the `MaxSync` position. After this the robot will move unsynchronized at programmed speed. If optional parameter `MaxSync` is not defined the robot will move synchronized until the instruction `SyncToSensor Ssync1\Off` is executed.

[\On]

Data type: switch

The robot moves synchronized with the sensor after an instruction using the argument `\On`.

[\Off]

Data type: switch

The robot moves unsynchronized with the sensor after an instruction using the argument `\Off`.

Program execution

`SyncToSensor Ssync1 \On` means that the robot starts to move synchronized with sensor `Ssync1`. So the robot passes at the taught `robtarg` at the same time as the sensor passes the external position stored in the `robtarg`.

`SyncToSensor Ssync1 \Off` means that the robot stops moving synchronized with the sensor.

Continues on next page

Limitations

If the instruction `SyncToSensor Ssync1 \On` is issued while the sensor has not been connected via `WaitSensor` then the robot will stop.

Syntax

```
SyncToSensor  
  [ MechUnit ':' ] < variable (VAR) of mecunit >  
  [ \MaxSync ] [ '\ On' | [ '\ Off' ] ';' ;
```

Related information

For information about	See
Start synchronized sensor supervision	SupSyncSensorOn - Start synchronized sensor supervision on page 834
Sync to sensor	SyncToSensor - Sync to sensor on page 854
Wait for connection on sensor	WaitSensor - Wait for connection on sensor on page 1067
Drop object on sensor	DropSensor - Drop object on sensor on page 188
<i>Machine Synchronization</i>	<i>Application manual - Controller software IRC5</i>

1 Instructions

1.297 SystemStopAction - Stop the robot system

RobotWare Base

1.297 SystemStopAction - Stop the robot system

Usage

`SystemStopAction` can be used to stop the robot system in different ways depending how serious the error or problem is.

Basic examples

The following examples illustrate the instruction `SystemStopAction`:

Example 1

```
SystemStopAction \Stop;
```

This will stop program execution and robot movements in all motion tasks. No specific action is needed to be done before restarting the program execution.

Example 2

```
SystemStopAction \StopBlock;
```

This will stop program execution and robot movements in all motion tasks. All program pointers must be moved before the program execution can be restarted.

Example 3

```
SystemStopAction \Halt;
```

This will result in motors off, stop program execution, and robot movements in all motion tasks. Motors on must be done before the program execution can be restarted.

Arguments

```
SystemStopAction [\Stop] [\StopBlock] [\Halt]
```

`[\Stop]`

Data type: switch

`\Stop` is used to stop program execution and robot movements in all motion tasks. No specific action is needed to be done before restart of the program execution.

`[\StopBlock]`

Data type: switch

`\StopBlock` is used stop program execution and robot movements in all motion tasks. All program pointers must be moved before the program execution can be restarted.

`[\Halt]`

Data type: switch

`\Halt` will result in motors off state, stop of program execution and robot movements in all motion tasks. Motors on must be done before the program execution can be restarted.

Program execution

`SystemStopAction` is used to stop the robot system in different ways depending how serious the error or problem is. The program execution is stopped in the executing task if the task is a normal task.

Continues on next page

If executing the `SystemStopAction` in a static or semistatic task, the program execution will stop for all normal tasks but continue for that task. See more about declaration of tasks in documentation for System Parameters.

Limitations

If the robot is performing a circular movement during a `SystemStopAction` `\StopBlock` then the program pointer and the robot have to be moved to the beginning of the circular movement before the program execution is restarted.

Syntax

```
SystemStopAction
  [ '\Stop ]
  | [ '\StopBlock ]
  | [ '\Halt ]';'
```

Related information

For information about	See
Stop program execution	Stop - Stops program execution on page 815
Terminate program execution	EXIT - Terminates program execution on page 207
Only stop robot movements	StopMove - Stops robot movement on page 820
Write some error message	ErrLog - Write an error message on page 197

1 Instructions

1.298 TEST - Depending on the value of an expression ...

RobotWare Base

1.298 TEST - Depending on the value of an expression ...

Usage

TEST is used when different instructions are to be executed depending on the value of an expression or data.

If there are not too many alternatives then the **IF . . ELSE** instruction can also be used.

Basic examples

The following example illustrates the instruction **TEST**:

Example 1

```
TEST reg1
CASE 1,2,3 :
  routine1;
CASE 4 :
  routine2;
DEFAULT :
  TPWrite "Illegal choice";
  Stop;
ENDTEST
```

Different instructions are executed depending on the value of `reg1`. If the value is 1, 2, or 3, then `routine1` is executed. If the value is 4, then `routine2` is executed. Otherwise, an error message is printed and execution stops.

Arguments

```
TEST Test data {CASE Test value {, Test value} : ...} [ DEFAULT:
... ] ENDTEST
```

Test data

Data type: All

The data or expression with which the test value will be compared.

Test value

Data type: Same as test data

The value which the test data must have for the associated instructions to be executed.

Program execution

The test data is compared with the test values in the first **CASE** condition. If the comparison is true then the associated instructions are executed. After that, program execution continues with the instruction following **ENDTEST**.

If the first **CASE** condition is not satisfied then other **CASE** conditions are tested and so on. If none of the conditions are satisfied then the instructions associated with **DEFAULT** are executed (if this is present).

Syntax

```
TEST <expression>
```

Continues on next page

```
{ CASE <test value> { ',' <test value> } ':'  
  <statement list> }  
[ DEFAULT ':'  
  <statement list> ]  
ENDTEST
```

Related information

For information about	See
Expressions	<i>Technical reference manual - RAPID Instructions, Functions and Data types</i>

1 Instructions

1.299 TestSignDefine - Define test signal

RobotWare Base

1.299 TestSignDefine - Define test signal

Usage

`TestSignDefine` is used to define one test signal for the robot motion system.

A test signal continuously mirrors some specified motion data stream. For example, torque reference for some specified axis. The actual value at a certain time can be read in RAPID with the function `TestSignRead`.

Only test signals for external axes can be reached. Test signals are also available on request for the robot axes and for not predefined test signals for external axes.

Basic examples

The following example illustrates the instruction `TestSignDefine`:

Example 1

```
TestSignDefine 1, testsignal_resolver_angle, Orbit, 2, 0.1;
```

Test signal `resolver_angle` connected to channel 1 will give the value of the resolver angle for external axis 2 on the `orbit` manipulator, sampled at 100 ms rate.

Arguments

```
TestSignDefine Channel SignalId MechUnit Axis SampleTime
```

Channel

Data type: num

The channel numbers 1-12 to be used for the test signal. The same number must be used in the function `TestSignRead` for reading the actual value of the test signal.

SignalId

Data type: testsignal

The name or number of the test signal. See predefined constants described in data type `testsignal`.

MechUnit

Mechanical Unit

Data type: mecunit

The name of the mechanical unit.

Axis

Data type: num

The axis number within the mechanical unit.

SampleTime

Data type: num

Sample time in seconds.

Continues on next page

For sample time < 0.004 s, the function `TestSignRead` returns the mean value of the latest available internal samples as shown in the table below.

Sample Time in seconds	Result from TestSignRead
0	Mean value of the latest 8 samples generated each 0.5 ms
0.001	Mean value of the latest 4 samples generated each 1 ms
0.002	Mean value of the latest 2 samples generated each 2 ms
Greater or equal to 0.004	Momentary value generated at specified sample time
0.1	Momentary value generated at specified sample time 100 ms

Program execution

The definition of test signal is activated and the robot system starts the sampling of the test signal.

The sampling of the test signal is active until:

- A new `TestSignDefine` instruction for the actual channel is executed.
- All test signals are deactivated with execution of instruction `TestSignReset`.
- All test signals are deactivated at a Restart of the system.

Error handling

The following recoverable errors are generated and can be handled in an error handler. The system variable `ERRNO` will be set to:

Name	Cause of error
<code>ERR_AXIS_PAR</code>	There is an error in the parameter <code>Axis</code> .
<code>ERR_UNIT_PAR</code>	There is an error in the parameter <code>MechUnit</code> .

Syntax

```
TestSignDefine
  [ Channel ' := ' ] < expression (IN) of num> ' , '
  [ SignalId ' := ' ] < expression (IN) of testsignal> ' , '
  [ MechUnit ' := ' ] < variable (VAR) of mecunit> ' , '
  [ Axis ' := ' ] < expression (IN) of num> ' , '
  [ SampleTime ' := ' ] < expression (IN) of num > ' ; '
```

Related information

For information about	See
Test signal	testsignal - Test signal on page 1774
Read test signal	TestSignRead - Read test signal value on page 1519
Reset test signals	TestSignReset - Reset all test signal definitions on page 862

1 Instructions

1.300 TestSignReset - Reset all test signal definitions

RobotWare Base

1.300 TestSignReset - Reset all test signal definitions

Usage

`TestSignReset` is used to deactivate all previously defined test signals.

Basic examples

The following example illustrates the instruction `TestSignReset`:

Example 1

```
TestSignReset;
```

Deactivate all previously defined test signals.

Program execution

The definitions of all test signals are deactivated, and the robot system stops the sampling of any test signals.

The sampling of defined test signals is active until:

- A Restart of the system
 - Execution of this instruction `TestSignReset`
-

Syntax

```
TestSignReset';'
```

Related information

For information about	See
Test signal	testsignal - Test signal on page 1774
Define test signal	TestSignDefine - Define test signal on page 860
Read test signal	TestSignRead - Read test signal value on page 1519

1.301 TextTabInstall - Installing a text table

Usage

`TextTabInstall` is used to install a text table in the system.

Basic examples

The following example illustrates the instruction `TextTabInstall`.

Example 1

```
! System Module with Event Routine to be executed at event
! POWER ON, RESET or START
```

```
PROC install_text()
  IF TextTabFreeToUse("text_table_name") THEN
    TextTabInstall "HOME:/text_file.xml";
  ENDIF
ENDPROC
```

The first time the event routine `install_text` is executed the function `TextTabFreeToUse` returns **TRUE**, and the text file `text_file.xml` is installed in the system. After that, the installed text strings can be fetched from the system to **RAPID** by the functions `TextTabGet` and `TextGet`.

The next time the event routine `install_text` is executed, the function `TextTabFreeToUse` returns **FALSE**, and the installation is not repeated.

Arguments

`TextTabInstall` File

File

Data type: string

The file path and the file name to the file that contains text strings to be installed in the system.

Error handling

The following recoverable errors are generated and can be handled in an error handler. The system variable `ERRNO` will be set to:

Name	Cause of error
<code>ERR_FILEOPEN</code>	The file in the <code>TextTabInstall</code> instruction cannot be opened.

Limitations

Limitations for installation of text tables (text resources) in the system:

- It is not possible to install the same text table more than once in the system.
 - It is not possible to uninstall (free) a single text table from the system. The only way to uninstall text tables from the system is to restart the controller using the restart mode **Reset system**. All text tables (both system and user defined) will then be uninstalled.
-

Continues on next page

1 Instructions

1.301 TextTabInstall - Installing a text table

RobotWare Base

Continued

Syntax

```
TextTabInstall  
  [File ':='] <expression (IN) of string>';'
```

Related information

For information about	See
Test whether text table is free	TextTabFreeToUse - Test whether text table is free on page 1524
Format of text files	<i>Technical reference manual - RAPID kernel</i>
Get text table number	TextTabGet - Get text table number on page 1526
Get text from system text tables	TextGet - Get text from system text tables on page 1521
String functions	<i>Technical reference manual - RAPID Overview</i>
Definition of string	string - Strings on page 1761
<i>Advanced RAPID</i>	<i>Application manual - Controller software IRC5</i>

1.302 TPErase - Erases text printed on the FlexPendant

Usage

TPErase (*FlexPendant Erase*) is used to clear the display of the FlexPendant.

Basic examples

The following example illustrates the instruction TPErase:

Example 1

```
TPErase;  
TPWrite "Execution started";
```

The FlexPendant display is cleared before Execution started is written.

Program execution

The FlexPendant display is completely cleared of all text. The next time text is written it will be entered on the uppermost line of the display.

Syntax

```
TPErase;
```

Related information

For information about	See
Writing on the FlexPendant	<i>Technical reference manual - RAPID Overview</i>

1 Instructions

1.303 TPReadDnum - Reads a number from the FlexPendant

RobotWare Base

1.303 TPReadDnum - Reads a number from the FlexPendant

Usage

TPReadDnum (*FlexPendant Read Numerical*) is used to read a number from the FlexPendant

Basic examples

The following example illustrates the instruction TPReadDnum:

Example 1

```
VAR dnum value;
```

```
TPReadDnum value, "How many units should be produced?";
```

The text `How many units should be produced?` is written on the FlexPendant display. Program execution waits until a number has been input from the numeric keyboard on the FlexPendant. That number is stored in `value`.

Arguments

```
TPReadDnum TPAnswer TPText [\MaxTime][\DIBreak] [\DIPassive]  
[\DOBreak] [\DOPassive] [\PersBoolBreak] [\PersBoolPassive]  
[\BreakFlag]
```

TPAnswer

Data type: `dnum`

The variable for which the number input via the FlexPendant is returned.

TPText

Data type: `string`

The information text to be written on the FlexPendant.

The string length is limited to 80 characters, with 40 characters per row.

[\MaxTime]

Data type: `num`

The maximum amount of time that program execution waits. If no number is input within this time, the program continues to execute in the error handler unless the `BreakFlag` is used (see below). The constant `ERR_TP_MAXTIME` can be used to test whether or not the maximum time has elapsed.

[\DIBreak]

Digital Input Break

Data type: `signal di`

The digital signal that may interrupt the operator dialog. If no number is input when the signal is set to 1 (or is already 1), the program continues to execute in the error handler unless the `BreakFlag` is used (see below). The constant `ERR_TP_DIBREAK` can be used to test whether or not this has occurred.

[\DIPassive]

Digital Input Passive

Continues on next page

1.303 TPReadDnum - Reads a number from the FlexPendant RobotWare Base Continued

Data type: `switch`

This switch overrides the default behavior when using `DIBreak` optional argument. Instead of reacting when signal is set to 1 (or already 1), the instruction should continue in the error handler (if no `BreakFlag` is used) when the signal `DIBreak` is set to 0 (or already is 0). The constant `ERR_TP_DIBREAK` can be used to test whether or not this has occurred.

`[\DOBreak]`

Digital Output Break

Data type: `signaldo`

The digital signal that support termination request from other tasks. If no button is selected when the signal is set to 1 (or is already 1), the program continues to execute in the error handler, unless the `BreakFlag` is used (see below). The constant `ERR_TP_DOBREAK` can be used to test whether or not this has occurred.

`[\DOPassive]`

Digital Output Passive

Data type: `switch`

This switch overrides the default behavior when using `DOBreak` optional argument. Instead of reacting when signal is set to 1 (or already 1), the instruction should continue in the error handler (if no `BreakFlag` is used) when the signal `DOBreak` is set to 0 (or already is 0). The constant `ERR_TP_DOBREAK` can be used to test whether or not this has occurred.

`[\PersBoolBreak]`

Persistent Boolean Break

Data type: `bool`

The persistent boolean that may interrupt the operator dialog. If no button is selected when the persistent boolean is set to `TRUE` (or is already `TRUE`) then the program continues to execute in the error handler unless the `BreakFlag` is used (see below). The constant `ERR_TP_PERSBOOLBREAK` can be used to test whether or not this has occurred.

`[\PersBoolPassive]`

Persistent Boolean Passive

Data type: `switch`

This switch overrides the default behavior when using `PersBoolBreak` optional argument. Instead of reacting when persistent boolean is set to `TRUE` (or already `TRUE`), the instruction should continue in the error handler (if no `BreakFlag` is used) when the persistent boolean `PersBoolBreak` is set to `FALSE` (or already is `FALSE`). The constant `ERR_TP_PERSBOOLBREAK` can be used to test whether or not this has occurred.

`[\BreakFlag]`

Data type: `errnum`

A variable that will hold the error code if `MaxTime`, `DIBreak`, `DOBreak`, or `PersBoolBreak` is used. If this optional variable is omitted then the error handler

Continues on next page

1 Instructions

1.303 TPReadDnum - Reads a number from the FlexPendant

RobotWare Base

Continued

will be executed. The constants `ERR_TP_MAXTIME`, `ERR_TP_DIBREAK`, `ERR_TP_DOBREAK`, and `ERR_TP_PERSBOOLBREAK` can be used to select the reason.

Program execution

The information text is always written on a new line. If the display is full of text, this body of text is moved up one line first. There can be up to 7 lines above the new text written.

Program execution waits until a number is typed on the numeric keyboard (followed by Enter or OK) or the instruction is interrupted by a time out or signal action..

Reference to `TPReadFK` about description of concurrent `TPReadFK` or `TPReadDnum` request on FlexPendant from same or other program tasks.

Error handling

The following recoverable errors are generated and can be handled in an error handler. The system variable `ERRNO` will be set to:

Name	Cause of error
<code>ERR_NO_ALIASIO_DEF</code>	The signal variable is a variable declared in RAPID. It has not been connected to an I/O signal defined in the I/O configuration with instruction <code>AliasIO</code> .
<code>ERR_TP_MAXTIME</code>	Time-out (parameter <code>\MaxTime</code>) before input from the operator.
<code>ERR_TP_DIBREAK</code>	A read instruction from FlexPendant was interrupted by a digital input. A digital input was set (parameter <code>\DIBreak</code>) before input from the operator.
<code>ERR_TP_DOBREAK</code>	A read instruction from FlexPendant was interrupted by a digital output. A digital output was set(parameter <code>\DOBreak</code>) before input from the operator.
<code>ERR_TP_NO_CLIENT</code>	No client to interact with when using a read instruction from FlexPendant.
<code>ERR_TP_PERSBOOLBREAK</code>	A read instruction from FlexPendant was interrupted by a persistent boolean. A persistent boolean was changed (parameter <code>\PersBoolBreak</code>) before input from the operator.

Syntax

```
TPReadDnum
  [TPAnswer':=' ] <var or pers (INOUT) of dnum>', '
  [TPText':=' ] <expression (IN) of string>
  ['\MaxTime':=' <expression (IN) of num>]
  ['\DIBreak':=' <variable (VAR) of signaldi>]
  ['\DIPassive]
  ['\DOBreak':=' <variable (VAR) of signaldo>]
  ['\DOPassive]
  ['\PersBoolBreak ':=' <persistent (PERS) of bool>]
  ['\PersBoolPassive]
  ['\BreakFlag':=' <var or pers (INOUT) of errnum> ' ;'
```

Continues on next page

1.303 TPReadDnum - Reads a number from the FlexPendant RobotWare Base Continued

Related information

For information about	See
Writing to and reading from the FlexPendant	<i>Technical reference manual - RAPID Overview</i>
Entering a number on the FlexPendant	<i>Operating manual - IRC5 with FlexPendant</i>
Examples of how to use the arguments MaxTime, DIBreak and BreakFlag	TPReadFK - Reads function keys on page 870
Clean up the Operator window	TPErase - Erases text printed on the FlexPendant on page 865

1 Instructions

1.304 TPReadFK - Reads function keys *RobotWare Base*

1.304 TPReadFK - Reads function keys

Usage

TPReadFK (*FlexPendant Read Function Key*) is used to write text on the functions keys and to find out which key is pressed.

Basic examples

The following example illustrates the instruction TPReadFK:

See also [More examples on page 873](#).

Example 1

```
TPReadFK reg1, "More?", stEmpty, stEmpty, stEmpty, "Yes", "No";
```

The text `More?` is written on the FlexPendant display and the function keys 4 and 5 are activated by means of the text strings `Yes` and `No` respectively (see figure below). Program execution waits until one of the function keys 4 or 5 is pressed. In other words, `reg1` will be assigned 4 or 5 depending on which of the keys are pressed.

The figure shows that the operator can put in information via the function keys.

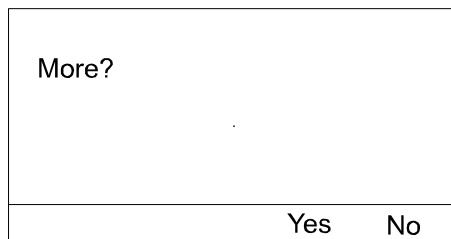

xx0500002345

Arguments

```
TPReadFK TPAnswer TPText TPFK1 TPFK2 TPFK3 TPFK4 TPFK5 [\MaxTime]  
[\DIBreak] [\DIPassive] [\DOBBreak] [\DOPassive]  
[\PersBoolBreak] [\PersBoolPassive] [\BreakFlag]
```

TPAnswer

Data type: num

The variable for which, depending on which key is pressed, the numeric value 1..5 is returned. If the function key 1 is pressed then 1 is returned, and so on.

TPText

Data type: string

The information text to be written on the FlexPendant.

The string length is limited to 80 characters, with 40 characters per row.

TPFKx

Function key text

Data type: string

The text to be written on the appropriate function key (a maximum of 45 characters). TPFK1 is the left-most key.

Continues on next page

Function keys without text are specified by the predefined string constant `stEmpty` with value empty string ("").

[\MaxTime]

Data type: num

The maximum amount of time in seconds that program execution waits. If no function key is pressed within this time then the program continues to execute in the error handler unless the `BreakFlag` is used (see below). The constant `ERR_TP_MAXTIME` can be used to test whether or not the maximum time has elapsed.

[\DIBreak]

Digital Input Break

Data type: signaldi

The digital signal that may interrupt the operator dialog. If no function key is pressed when the signal is set to 1 (or is already 1) then the program continues to execute in the error handler unless the `BreakFlag` is used (see below). The constant `ERR_TP_DIBREAK` can be used to test whether or not this has occurred.

[\DIPassive]

Digital Input Passive

Data type: switch

This switch overrides the default behavior when using `DIBreak` optional argument. Instead of reacting when signal is set to 1 (or already 1), the instruction should continue in the error handler (if no `BreakFlag` is used) when the signal `DIBreak` is set to 0 (or already is 0). The constant `ERR_TP_DIBREAK` can be used to test whether or not this has occurred.

[\DOBreak]

Digital Output Break

Data type: signaldo

The digital signal that supports termination request from other tasks. If no button is selected when the signal is set to 1 (or is already 1) then the program continues to execute in the error handler unless the `BreakFlag` is used (see below). The constant `ERR_TP_DOBREAK` can be used to test whether or not this has occurred.

[\DOPassive]

Digital Output Passive

Data type: switch

This switch overrides the default behavior when using `DOBreak` optional argument. Instead of reacting when signal is set to 1 (or already 1), the instruction should continue in the error handler (if no `BreakFlag` is used) when the signal `DOBreak` is set to 0 (or already is 0). The constant `ERR_TP_DOBREAK` can be used to test whether or not this has occurred.

[\PersBoolBreak]

Persistent Boolean Break

Continues on next page

1 Instructions

1.304 TPReadFK - Reads function keys

RobotWare Base

Continued

Data type: `bool`

The persistent boolean that may interrupt the operator dialog. If no button is selected when the persistent boolean is set to `TRUE` (or is already `TRUE`) then the program continues to execute in the error handler unless the `BreakFlag` is used (see below). The constant `ERR_TP_PERSBOOLBREAK` can be used to test whether or not this has occurred.

`[\PersBoolPassive]`

Persistent Boolean Passive

Data type: `switch`

This switch overrides the default behavior when using `PersBoolBreak` optional argument. Instead of reacting when persistent boolean is set to `TRUE` (or already `TRUE`), the instruction should continue in the error handler (if no `BreakFlag` is used) when the persistent boolean `PersBoolBreak` is set to `FALSE` (or already is `FALSE`). The constant `ERR_TP_PERSBOOLBREAK` can be used to test whether or not this has occurred.

`[\BreakFlag]`

Data type: `errnum`

A variable that will hold the error code if `MaxTime`, `DIBreak`, `DOBreak`, or `PersBoolBreak` is used. If this optional variable is omitted then the error handler will be executed. The constants `ERR_TP_MAXTIME`, `ERR_TP_DIBREAK`, `ERR_TP_DOBREAK`, and `ERR_TP_PERSBOOLBREAK` can be used to select the reason.

Program execution

The information text is always written on a new line. If the display is full of text then this body of text is moved up one line first. There can be up to 7 lines above the new written text.

Text is written on the appropriate function keys.

Program execution waits until one of the activated function keys are pressed.

Description of concurrent `TPReadFK` or `TPReadNum` request on FlexPendant (TP request) from the same or other program tasks:

- New TP request from other program tasks will not take focus (new put in queue)
- New TP request from a trap routine in the same program task will take focus (old put in queue)
- Program stop take focus (old put in queue)
- New TP request in program stop state takes focus (old put in queue)

Predefined data

```
CONST string stEmpty := "";
```

The predefined constant `stEmpty` can be used for Function Keys without text.

Continues on next page

Error handling

The following recoverable errors are generated and can be handled in an error handler. The system variable `ERRNO` will be set to:

Name	Cause of error
<code>ERR_NO_ALIASIO_DEF</code>	The signal variable is a variable declared in RAPID. It has not been connected to an I/O signal defined in the I/O configuration with instruction <code>AliasIO</code> .
<code>ERR_TP_MAXTIME</code>	Time-out (parameter <code>\MaxTime</code>) before input from the operator.
<code>ERR_TP_DIBREAK</code>	A read instruction from FlexPendant was interrupted by a digital input. A digital input was set (parameter <code>\DIBreak</code>) before input from the operator.
<code>ERR_TP_DOBREAK</code>	A read instruction from FlexPendant was interrupted by a digital output. A digital output was set (parameter <code>\DOBreak</code>) before input from the operator.
<code>ERR_TP_NO_CLIENT</code>	No client to interact with when using a read instruction from FlexPendant.
<code>ERR_TP_PERSBOOLBREAK</code>	A read instruction from FlexPendant was interrupted by a persistent boolean. A persistent boolean was changed (parameter <code>\PersBoolBreak</code>) before input from the operator.

More examples

More examples of how to use the instruction `TPReadFK` are illustrated below.

Example 1

```

VAR errnum errvar;
...
TPReadFK reg1, "Go to service position?", stEmpty, stEmpty, stEmpty,
  "Yes", "No"
\MaxTime:= 600
  \DIBreak:= di5\BreakFlag:= errvar;
IF reg1 = 4 OR errvar = ERR_TP_DIBREAK THEN
  MoveL service, v500, fine, tool1;
  Stop;
ENDIF
IF errvar = ERR_TP_MAXTIME EXIT;

```

The robot is moved to the service position if the forth function key ("Yes") is pressed or if the input 5 is activated. If no answer is given within 10 minutes then the execution is terminated.

Limitations

Avoid using too low values for the timeout parameter `\MaxTime` when `TPReadFK` is frequently executed, for example in a loop. It can result in an unpredictable behavior of the system performance, like slowing the FlexPendant response.

Continues on next page

1 Instructions

1.304 TPReadFK - Reads function keys

RobotWare Base

Continued

Syntax

```
TPReadFK
[TPAnswer ':='] <var or pers (INOUT) of num>', '
[TPText ':='] <expression (IN) of string>', '
[TPFK1 ':='] <expression (IN) of string>', '
[TPFK2 ':='] <expression (IN) of string>', '
[TPFK3 ':='] <expression (IN) of string>', '
[TPFK4 ':='] <expression (IN) of string>', '
[TPFK5 ':='] <expression (IN) of string>
['\ ' MaxTime ':=' <expression (IN) of num>]
['\ ' DIBreak ':=' <variable (VAR) of signaldi>]
['\ ' DIPassive]
['\ ' DOBreak ':=' <variable (VAR) of signaldo>]
['\ ' DOPassive]
['\ ' PersBoolBreak ':=' <persistent (PERS) of bool>]
['\ ' PersBoolPassive]
['\ ' BreakFlag ':=' <var or pers (INOUT) of errnum>]';'
```

Related information

For information about	See
Writing to and reading from the FlexPendant	<i>Technical reference manual - RAPID Overview</i>
Replying via the FlexPendant	<i>Operating manual - IRC5 with FlexPendant</i>
Clean up the Operator window	TPErase - Erases text printed on the FlexPendant on page 865

1.305 TPreadNum - Reads a number from the FlexPendant

Usage

TPreadNum (*FlexPendant Read Numerical*) is used to read a number from the FlexPendant.

Basic examples

The following example illustrates the instruction `TPreadNum`:

See also [More examples on page 877](#).

Example 1

```
TPreadNum reg1, "How many units should be produced?";
```

The text `How many units should be produced?` is written on the FlexPendant display. Program execution waits until a number has been input from the numeric keyboard on the FlexPendant. That number is stored in `reg1`.

Arguments

```
TPreadNum TPAnswer TPText [\MaxTime][\DIBreak] [\DIPassive]
[\DOBreak] [\DOPassive] [\PersBoolBreak] [\PersBoolPassive]
[\BreakFlag]
```

TPAnswer

Data type: num

The variable for which the number input via the FlexPendant is returned.

TPText

Data type: string

The information text to be written on the FlexPendant.

The string length is limited to 80 characters, with 40 characters per row.

[\MaxTime]

Data type: num

The maximum amount of time that program execution waits. If no number is input within this time, the program continues to execute in the error handler unless the `BreakFlag` is used (see below). The constant `ERR_TP_MAXTIME` can be used to test whether or not the maximum time has elapsed.

[\DIBreak]

Digital Input Break

Data type: signaldi

The digital signal that may interrupt the operator dialog. If no number is input when the signal is set to 1 (or is already 1), the program continues to execute in the error handler unless the `BreakFlag` is used (see below). The constant `ERR_TP_DIBREAK` can be used to test whether or not this has occurred.

[\DIPassive]

Digital Input Passive

Data type: switch

Continues on next page

1 Instructions

1.305 TPReadNum - Reads a number from the FlexPendant

RobotWare Base

Continued

This switch overrides the default behavior when using `DIBreak` optional argument. Instead of reacting when signal is set to 1 (or already 1), the instruction should continue in the error handler (if no `BreakFlag` is used) when the signal `DIBreak` is set to 0 (or already is 0). The constant `ERR_TP_DIBREAK` can be used to test whether or not this has occurred.

`[\DOBreak]`

Digital Output Break

Data type: `signaldo`

The digital signal that supports termination request from other tasks. If no button is selected when the signal is set to 1 (or is already 1), the program continues to execute in the error handler unless the `BreakFlag` is used (see below). The constant `ERR_TP_DOBREAK` can be used to test whether or not this has occurred.

`[\DOPassive]`

Digital Output Passive

Data type: `switch`

This switch overrides the default behavior when using `DOBreak` optional argument. Instead of reacting when signal is set to 1 (or already 1), the instruction should continue in the error handler (if no `BreakFlag` is used) when the signal `DOBreak` is set to 0 (or already is 0). The constant `ERR_TP_DOBREAK` can be used to test whether or not this has occurred.

`[\PersBoolBreak]`

Persistent Boolean Break

Data type: `bool`

The persistent boolean that may interrupt the operator dialog. If no button is selected when the persistent boolean is set to `TRUE` (or is already `TRUE`) then the program continues to execute in the error handler unless the `BreakFlag` is used (see below). The constant `ERR_TP_PERSBOOLBREAK` can be used to test whether or not this has occurred.

`[\PersBoolPassive]`

Persistent Boolean Passive

Data type: `switch`

This switch overrides the default behavior when using `PersBoolBreak` optional argument. Instead of reacting when persistent boolean is set to `TRUE` (or already `TRUE`), the instruction should continue in the error handler (if no `BreakFlag` is used) when the persistent boolean `PersBoolBreak` is set to `FALSE` (or already is `FALSE`). The constant `ERR_TP_PERSBOOLBREAK` can be used to test whether or not this has occurred.

`[\BreakFlag]`

Data type: `errnum`

A variable that will hold the error code if `MaxTime`, `DIBreak`, `DOBreak`, or `PersBoolBreak` is used. If this optional variable is omitted then the error handler

Continues on next page

1.305 TPreadNum - Reads a number from the FlexPendant RobotWare Base Continued

will be executed. The constants `ERR_TP_MAXTIME`, `ERR_TP_DIBREAK`, `ERR_TP_DOBREAK`, and `ERR_TP_PERSBOOLBREAK` can be used to select the reason.

Program execution

The information text is always written on a new line. If the display is full of text, this body of text is moved up one line first. There can be up to 7 lines above the new text written.

Program execution waits until a number is typed on the numeric keyboard (followed by Enter or OK) or the instruction is interrupted by a time out or signal action.

Reference to `TPreadFK` about description of concurrent `TPreadFK` or `TPreadNum` request on FlexPendant from same or other program tasks.

Error handling

The following recoverable errors are generated and can be handled in an error handler. The system variable `ERRNO` will be set to:

Name	Cause of error
<code>ERR_NO_ALIASIO_DEF</code>	The signal variable is a variable declared in RAPID. It has not been connected to an I/O signal defined in the I/O configuration with instruction <code>AliasIO</code> .
<code>ERR_TP_MAXTIME</code>	Time-out (parameter <code>\MaxTime</code>) before input from the operator.
<code>ERR_TP_DIBREAK</code>	A read instruction from FlexPendant was interrupted by a digital input. A digital input was set (parameter <code>\DIBreak</code>) before input from the operator.
<code>ERR_TP_DOBREAK</code>	A read instruction from FlexPendant was interrupted by a digital output. A digital output was set (parameter <code>\DOBreak</code>) before input from the operator.
<code>ERR_TP_NO_CLIENT</code>	No client to interact with when using a read instruction from FlexPendant.
<code>ERR_TP_PERSBOOLBREAK</code>	A read instruction from FlexPendant was interrupted by a persistent boolean. A persistent boolean was changed (parameter <code>\PersBoolBreak</code>) before input from the operator.

More examples

More examples of how to use the instruction `TPreadNum` are illustrated below.

Example 1

```
TPreadNum reg1, "How many units should be produced?";
FOR i FROM 1 TO reg1 DO
  produce_part;
ENDFOR
```

The text `How many units should be produced?` is written on the FlexPendant display. The routine `produce_part` is then repeated the number of times that is input via the FlexPendant.

Continues on next page

1 Instructions

1.305 TPReadNum - Reads a number from the FlexPendant

RobotWare Base

Continued

Syntax

```
TPReadNum
  [TPAnswer':=' ] <var or pers (INOUT) of num>','
  [TPText':=' ] <expression (IN) of string>
  ['\'MaxTime':=' <expression (IN) of num>]
  ['\'DIBreak':=' <variable (VAR) of signaldi>]
  ['\'DIPassive]
  ['\'DOBreak':=' <variable (VAR) of signaldo>]
  ['\'DOPassive]
  ['\'PersBoolBreak ':=' <persistent (PERS) of bool>]
  ['\'PersBoolPassive]
  ['\'BreakFlag':=' <var or pers (INOUT) of errnum>] ';'

```

Related information

For information about	See
Writing to and reading from the FlexPendant	<i>Technical reference manual - RAPID Overview</i>
Entering a number on the FlexPendant	<i>Operating manual - IRC5 with FlexPendant</i>
Examples of how to use the arguments MaxTime, DIBreak and BreakFlag	TPReadFK - Reads function keys on page 870
Clean up the Operator window	TPErase - Erases text printed on the FlexPendant on page 865

1.306 TPSHOW - Switch window on the FlexPendant

Usage

TPSHOW (*FlexPendant Show*) is used to select FlexPendant window from RAPID.

Basic examples

The following example illustrates the instruction TPSHOW:

Example 1

```
TPSHOW TP_LATEST;
```

The latest used FlexPendant Window before the current FlexPendant window will be active after execution of this instruction.

Arguments

```
TPSHOW Window
```

Window

Data type: tpnum

The window TP_LATEST will show the latest used FlexPendant window before current FlexPendant window.

Program execution

The selected FlexPendant window will be activated.

Predefined data

```
CONST tpnum TP_LATEST := 2;
```

Syntax

```
TPSHOW  
[Window' :='] <expression (IN) of tpnum> ';' ;'
```

Related information

For information about	See
Communicating using the FlexPendant	<i>Technical reference manual - RAPID Overview</i>
FlexPendant Window number	tpnum - FlexPendant window number on page 1782
Clean up the Operator window	TPErase - Erases text printed on the FlexPendant on page 865

1 Instructions

1.307 TPWrite - Writes on the FlexPendant

RobotWare Base

1.307 TPWrite - Writes on the FlexPendant

Usage

TPWrite (*FlexPendant Write*) is used to write text on the FlexPendant. The value of certain data can be written as well as text.

Basic examples

The following examples illustrate the instruction TPWrite:

Example 1

```
TPWrite "Execution started";
```

The text `Execution started` is written on the FlexPendant.

Example 2

```
TPWrite "No of produced parts="\Num:=reg1;
```

If, for example, `reg1` holds the value 5 then the text `No of produced parts=5` is written on the FlexPendant.

Example 3

```
VAR string my_robot;  
...  
my_robot := RobName();  
IF my_robot="" THEN  
    TPWrite "This task does not control any TCP robot";  
ELSE  
    TPWrite "This task controls TCP robot with name "+ my_robot;  
ENDIF
```

Write to FlexPendant the name of the TCP robot which is controlled from this program task. If no TCP robot is controlled, write that the task controls no robot.

Arguments

```
TPWrite String [\Num] | [\Bool] | [\Pos] | [\Orient] | [\Dnum]
```

String

Data type: `string`

The text to be written on the FlexPendant.

The string length is limited to 80 characters, with 40 characters per row.

[\Num]

Numeric

Data type: `num`

The data whose numeric value is to be written after the text string.

[\Bool]

Boolean

Data type: `bool`

The data whose logical value is to be written after the text string.

Continues on next page

[\Pos]

Position**Data type:** pos

The data whose position is to be written after the text string.

[\Orient]

Orientation**Data type:** orient

The data whose orientation is to be written after the text string.

[\Dnum]

Numeric**Data type:** dnum

The data whose numeric value is to be written after the text string.

Program execution

Text written on the FlexPendant always begins on a new line. When the display is full of text (11 lines) then this text is moved up one line first.

If one of the arguments \Num, \Dnum, \Bool, \Pos, or \Orient is used then its value is first converted to a text string before it is added to the first string. The conversion from value to text string takes place as follows:

Argument	Value	Text string
\Num	23	"23"
\Num	1.141367	"1.14137"
\Bool	TRUE	"TRUE"
\Pos	[1817.3,905.17,879.11]	"[1817.3,905.17,879.11]"
\Orient	[0.96593,0,0.25882,0]	"[0.96593,0,0.25882,0]"
\Dnum	4294967295	"4294967295"

The value is converted to a string with standard RAPID format. This means, in principle, 6 significant digits. If the decimal part is less than 0.000005 or greater than 0.999995 then the number is rounded to an integer.

Limitations

The arguments \Num, \Dnum, \Bool, \Pos, and \Orient are mutually exclusive and thus cannot be used simultaneously in the same instruction.

Syntax

```
TPWrite
  [TPText':=' ] <expression (IN) of string>
  ['\Num':=' <expression (IN) of num> ]
  | ['\Bool':=' <expression (IN) of bool> ]
  | ['\Pos':=' <expression (IN) of pos> ]
  | ['\Orient':=' <expression (IN) of orient> ]
  | ['\Dnum':=' <expression (IN) of dnum> ]';'
```

Continues on next page

1 Instructions

1.307 TPWrite - Writes on the FlexPendant

RobotWare Base

Continued

Related information

For information about	See
Clearing and reading the FlexPendant	<i>Technical reference manual - RAPID Overview</i>
Clean up the Operator window	<i>TPEraser - Erases text printed on the FlexPendant on page 865</i>

1.308 TriggAbsJ - Absolute joint robot movements with events

Usage

`TriggAbsJ` is used to move the robot and external axes to an absolute position defined in axes positions, and set output signals and/or run interrupt routines at roughly fixed positions. For example, if the end point is a singular point.

The final position of the robot during a movement with `TriggAbsJ` is neither affected by the given tool and work object nor by active program displacement. The robot uses this data to calculate the load, TCP velocity, and the corner path. The same tools can be used in adjacent movement instructions.

The robot and external axes move to the destination position along a non-linear path. All axes reach the destination position at the same time.

This instruction can only be used in the main task `T_ROB1` or, if in a `MultiMove` system, in *Motion* tasks.

Basic examples

The following example illustrates the instruction `TriggAbsJ`.

Example 1

```
VAR triggdata triggdata1;
...
TriggIO triggdata1, 0 \Start \Dop:=gun, 1;
MoveL p1, v500, z50, tool1;
TriggAbsJ jpos10, v500, triggdata1, fine, tool1;
```

The digital output signal `gun` is set when the robot TCP passes the absolute axis position `jpos10`.

The figure shows an example of fixed position I/O event.

Arguments

```
TriggAbsJ [\Conc] ToJointPos [\ID] [\ NoEoffs] Speed [\T] Trigg_1
| TriggArray [ \T2 ] [ \T3 ] [\T4] [\T5] [\T6] [\T7] [\T8]
Zone [\Inpos] Tool [\WObj] [\TLoad]
```

[\Conc]

Concurrent

Data type: `switch`

Subsequent instructions are executed while the robot is moving. The argument is usually not used but can be used to avoid unwanted stops caused by overloaded CPU when using fly-by points. This is useful when the programmed points are very close together at high speeds. The argument is also useful when, for example, communicating with external equipment and synchronization between the external equipment and robot movement is not required.

Using the argument `\Conc`, the number of movement instructions in succession is limited to 5. In a program section that includes `StorePath-RestPath`, movement instructions with the argument `\Conc` are not permitted.

Continues on next page

1 Instructions

1.308 TriggAbsJ - Absolute joint robot movements with events

RobotWare Base

Continued

If this argument is omitted and the `ToPoint` is not a stop point then the subsequent instruction is executed some time before the robot has reached the programmed zone.

This argument cannot be used in coordinated synchronized movement in a MultiMove system.

`ToJointPos`

Data type: `jointtarget`

The destination absolute joint position of the robot and external axes. It is defined as a named position or stored directly in the instruction (marked with an * in the instruction).

[`\ID`]

Synchronization id

Data type: `identno`

The argument [`\ID`] is mandatory in MultiMove systems, if the movement is synchronized or coordinated synchronized. This argument is not allowed in any other case. The specified id number must be the same in all the cooperating program tasks. By using the id number the movements are not mixed up at the runtime.

[`\NoEOffs`]

No External Offsets

Data type: `switch`

If the argument `\NoEOffs` is set then the movement with `TriggAbsJ` is not affected by active offsets for external axes.

`Speed`

Data type: `speeddata`

The speed data that applies to movements. Speed data defines the velocity of the TCP, the tool reorientation, and external axes.

[`\T`]

Time

Data type: `num`

This argument is used to specify the total time in seconds during which the robot moves. It is substituted for the corresponding speed data. The speed data is computed under the assumption that the speed is constant during the movement. If the robot cannot keep this speed during the whole movement, for example, when the movement starts from a finepoint or ends in a finepoint, the actual movement time will be larger than the programmed time.

`Trigg_1`

Data type: `triggdata`

Variable that refers to trigger conditions and trigger activity defined earlier in the program using the instructions `TriggIO`, `TriggEquip`, `TriggInt`, `TriggCheckIO`, `TriggSpeed`, or `TriggRampAO`.

Continues on next page

TriggArray

Trigg Data Array Parameter

Data type: triggdata

Array variable that refers to trigger conditions and trigger activity defined earlier in the program using the instructions TriggIO, TriggEquip, TriggInt, TriggSpeed, TriggCheckIO, or TriggRampAO.

The limitation is 25 elements in the array and 1 to 25 defined trigger conditions must be defined.

It is not possible to use the optional arguments T2, T3, T4, T5, T6, T7, or T8 at the same time as the TriggArray argument is used.

[\T2]

Trigg 2

Data type: triggdata

Variable that refers to trigger conditions and trigger activity defined earlier in the program using the instructions TriggIO, TriggEquip, TriggInt, TriggCheckIO, TriggSpeed, or TriggRampAO.

[\T3]

Trigg 3

Data type: triggdata

Variable that refers to trigger conditions and trigger activity defined earlier in the program using the instructions TriggIO, TriggEquip, TriggInt, TriggCheckIO, TriggSpeed, or TriggRampAO.

[\T4]

Trigg 4

Data type: triggdata

Variable that refers to trigger conditions and trigger activity defined earlier in the program using the instructions TriggIO, TriggEquip, TriggInt, TriggCheckIO, TriggSpeed, or TriggRampAO.

[\T5]

Trigg 5

Data type: triggdata

Variable that refers to trigger conditions and trigger activity defined earlier in the program using the instructions TriggIO, TriggEquip, TriggInt, TriggCheckIO, TriggSpeed, or TriggRampAO.

[\T6]

Trigg 6

Data type: triggdata

Variable that refers to trigger conditions and trigger activity defined earlier in the program using the instructions TriggIO, TriggEquip, TriggInt, TriggCheckIO, TriggSpeed, or TriggRampAO.

Continues on next page

1 Instructions

1.308 TriggAbsJ - Absolute joint robot movements with events

RobotWare Base

Continued

[\T7]

Trigg 7

Data type: triggdata

Variable that refers to trigger conditions and trigger activity defined earlier in the program using the instructions TriggIO, TriggEquip, TriggInt, TriggCheckIO, TriggSpeed, or TriggRampAO.

[\T8]

Trigg 8

Data type: triggdata

Variable that refers to trigger conditions and trigger activity defined earlier in the program using the instructions TriggIO, TriggEquip, TriggInt, TriggCheckIO, TriggSpeed, or TriggRampAO.

Zone

Data type: zonedata

Zone data for the movement. Zone data describes the size of the generated corner path.

[\Inpos]

In position

Data type: stoppoint data

This argument is used to specify the convergence criteria for the position of the robot's TCP in the stop point. The stop point data substitutes the zone specified in the Zone parameter.

Tool

Data type: tooldata

The tool in use when the robot moves. The tool center point is the point that is moved to the specified destination point.

[\WObj]

Work Object

Data type: wobjdata

The work object (object coordinate system) to which the robot position in the instruction is related.

This argument can be omitted and if it is then the position is related to the world coordinate system. If, on the other hand, a stationary TCP or coordinated external axes are used this argument must be specified in order for a circle relative to the work object to be executed.

[\TLoad]

Total load

Data type: loaddata

Continues on next page

The `\TLoad` argument describes the total load used in the movement. The total load is the tool load together with the payload that the tool is carrying. If the `\TLoad` argument is used, then the `loaddata` in the current `tooldata` is not considered.

If the `\TLoad` argument is set to `load0`, then the `\TLoad` argument is not considered and the `loaddata` in the current `tooldata` is used instead.

To be able to use the `\TLoad` argument it is necessary to set the value of the system parameter `ModalPayloadMode` to 0. If `ModalPayloadMode` is set to 0, it is no longer possible to use the instruction `GripLoad`.

The total load can be identified with the service routine `LoadIdentify`. If the system parameter `ModalPayloadMode` is set to 0, the operator has the possibility to copy the `loaddata` from the tool to an existing or new `loaddata` persistent variable when running the service routine.

It is possible to test run the program without any payload by using a digital input signal connected to the system input `SimMode` (Simulated Mode). If the digital input signal is set to 1, the `loaddata` in the optional argument `\TLoad` is not considered, and the `loaddata` in the current `tooldata` is used instead.



Note

The default functionality to handle payload is to use the instruction `GripLoad`. Therefore the default value of the system parameter `ModalPayloadMode` is 1.

Program execution

See the instruction [MoveAbsJ - Moves the robot to an absolute joint position on page 395](#) for information about absolute joint position movement.

As the trigger conditions are fulfilled when the robot is positioned closer and closer to the end point, the defined trigger activities are carried out. The trigger conditions are fulfilled either at a certain distance before the end point of the instruction, or at a certain distance after the start point of the instruction, or at a certain point in time (limited to a short time) before the end point of the instruction.

During the stepping execution forward, the I/O activities are carried out but the interrupt routines are not run. During stepping the execution backwards, no trigger activities at all are carried out.

Error handling

The following recoverable errors are generated and can be handled in an error handler. The system variable `ERRNO` will be set to:

<code>ERR_AO_LIM</code>	The programmed <code>ScaleValue</code> argument for the specified analog output signal <code>AOp</code> in some of the connected <code>TriggSpeed</code> instructions result in out of limit for the analog signal together with the programmed speed in this instruction.
<code>ERR_DIPLAG_LIM</code>	The programmed <code>DipLag</code> argument in some of the connected <code>TriggSpeed</code> instructions is too big in relation to the used <code>Event Preset Time</code> in the system parameter configuration.

Continues on next page

1 Instructions

1.308 TriggAbsJ - Absolute joint robot movements with events

RobotWare Base

Continued

ERR_NORUNUNIT	There is no contact with the I/O device when entering instruction and the used <code>triggdata</code> depends on a running I/O device, i.e. a signal is used in the <code>triggdata</code> .
ERR_CONC_MAX	The number of movement instructions in succession using the argument <code>\Conc</code> has been exceeded.

More examples

More examples of the instruction `TriggAbsJ` are illustrated below.

Example 1

```
VAR intnum intnol;
VAR triggdata triggl;
...
PROC main()
  CONNECT intnol WITH trap1;
  TriggInt triggl, 0.1 \Time, intnol;
  ...
  TriggAbsJ jpos10, v500, triggl, fine, gun1;
  TriggAbsJ jpos20, v500, triggl, fine, gun1;
  ...
  IDelete intnol;
```

The interrupt routine `trap1` is run when the work point is at a position 0.1 seconds before the stop point `jpos10` or `jpos20` respectively.

Example 2

```
VAR num Distance:=0;
VAR triggdata trigg_array{25};
VAR signaldo myaliassignaldo;
VAR string signalname;
...
PROC main()
  ...
  FOR i FROM 1 TO 25 DO
    signalname:="do";
    signalname:=signalname+ValToStr(i);
    AliasIO signalname, myaliassignaldo;
    TriggEquip trigg_array{i}, Distance \Start, 0
      \DOp:=myaliassignaldo, SetValue:=1;
    Distance:=Distance+10;
  ENDFOR
  TriggAbsJ jpos10, v500, trigg_array, z30, tool2;
  MoveJ p2, v500, z30, tool2;
  ...
```

The digital output signals `do1` to `do25` is set during the movement to `jpos10`. The distance between the signal settings is 10 mm.

Continues on next page

Limitations

If the current start point deviates from the usual so that the total positioning length of the instruction `TriggAbsJ` is shorter than usual (for example, at the start of `TriggAbsJ` with the robot position at the end point), it may happen that several or all of the trigger conditions are fulfilled immediately and at the same position. In such cases, the sequence in which the trigger activities are carried will be undefined. The program logic in the user program may not be based on a normal sequence of trigger activities for an incomplete movement.

`TriggAbsJ` cannot be executed in an UNDO handler or RAPID routine connected to any of the following special system events: *PowerOn*, *Stop*, *QStop*, *Restart*, *Reset*, or *Step*.

Syntax

```
TriggAbsJ
[ '\ Conc ',' ]
[ ToJointPos' :=' ] < expression (IN) of jointtarget >
[ '\ ID :=' < expression (IN) of identno > ],'
[ '\ NoEoffs'],'
[ Speed :=' ] < expression (IN) of speeddata >
[ '\ T :=' < expression (IN) of num > ],'
[ Trigg_1 :=' ] < variable (VAR) of triggdata > |
[ TriggArray :=' ] < array variable {*} (VAR) of triggdata >
[ '\ T2 :=' < variable (VAR) of triggdata > ]
[ '\ T3 :=' < variable (VAR) of triggdata > ]
[ '\ T4 :=' < variable (VAR) of triggdata > ]
[ '\ T5 :=' < variable (VAR) of triggdata > ]
[ '\ T6 :=' < variable (VAR) of triggdata > ]
[ '\ T7 :=' < variable (VAR) of triggdata > ]
[ '\ T8 :=' < variable (VAR) of triggdata > ]
[ '\ KeepStartPath :=' < expression (IN) of num > ]
[ '\ KeepEndPath :=' < expression (IN) of num > ] ', '
[ Zone :=' ] < expression (IN) of zonedata >
[ '\ Inpos :=' < expression (IN) of stoppointdata > ],'
[ Tool :=' ] < persistent (PERS) of tooldata >
[ '\ WObj :=' < persistent (PERS) of wobjdata > ]
[ '\ TLoad :=' < persistent (PERS) of loaddata > ] ';'

```

Related information

For information about	See
Define the payload for the robot	GripLoad - Defines the payload for a robot on page 243
Example of how to use <code>TLoad</code>	MoveAbsJ - Moves the robot to an absolute joint position on page 395
Joint movements with triggers	TriggJ - Axis-wise robot movements with events on page 927

Continues on next page

1 Instructions

1.308 TriggAbsJ - Absolute joint robot movements with events

RobotWare Base

Continued

For information about	See
Definition of triggers	<i>TriggIO - Define a fixed position or time I/O event near a stop point on page 921</i> <i>TriggEquip - Define a fixed position and time I/O event on the path on page 910</i> <i>TriggRampAO - Define a fixed position ramp AO event on the path on page 958</i> <i>TriggInt - Defines a position related interrupt on page 916</i> <i>TriggCheckIO - Defines I/O check at a fixed position on page 900</i>

1.309 TriggC - Circular robot movement with events

Usage

TriggC (*Trigg Circular*) is used to set output signals and/or run interrupt routines at fixed positions at the same time that the robot is moving on a circular path.

One or more (max. 25) events can be defined using the instructions TriggIO, TriggEquip, TriggInt, TriggCheckIO, TriggSpeed, or TriggRampAO and afterwards these definitions are referred to in the instruction TriggC.

This instruction can only be used in the main task T_ROB1 or, if in a *MultiMove* system, in Motion tasks.

Basic examples

The following example illustrates the instruction TriggC:

See also [More examples on page 896](#).

Example 1

```
VAR triggdata gunon;

TriggIO gunon, 0 \Start \DOp:=gun, 1;
MoveL p1, v500, z50, gun1;
TriggC p2, p3, v500, gunon, fine, gun1;
```

The digital output signal `gun` is set when the robot's TCP passes the midpoint of the corner path of the point `p1`.

The figure shows an example of fixed position I/O event.

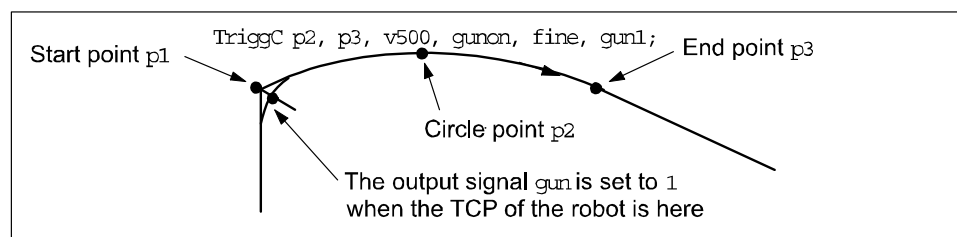

xx0500002267

Arguments

```
TriggC [\Conc] CirPoint ToPoint [\ID] Speed [\T] Trigg_1 |
TriggArray [\T2] [\T3] [\T4] [\T5] [\T6] [\T7] [\T8] Zone
[\Inpos] Tool [\WObj] [ \Corr ] [\TLoad]
```

[\Conc]

Concurrent

Data type: switch

Subsequent instructions are executed while the robot is moving. The argument is usually not used but can be used to avoid unwanted stops caused by overloaded CPU when using fly-by points. This is useful when the programmed points are very close together at high speeds. The argument is also useful when, for example,

Continues on next page

1 Instructions

1.309 TriggC - Circular robot movement with events

RobotWare Base

Continued

communicating with external equipment and synchronization between the external equipment and robot movement is not required.

Using the argument `\Conc`, the number of movement instructions in succession is limited to 5. In a program section that includes `StorePath-RestoPath`, movement instructions with the argument `\Conc` are not permitted.

If this argument is omitted and the `ToPoint` is not a stop point then the subsequent instruction is executed some time before the robot has reached the programmed zone.

This argument cannot be used in coordinated synchronized movement in a `MultiMove` system.

`CirPoint`

Data type: `robtarget`

The circle point of the robot. The circle point is a position on the circle between the start point and the destination point. To obtain the best accuracy it should be placed about halfway between the start and destination points. If it is placed too close to the start or destination point, the robot may give a warning. The circle point is defined as a named position or stored directly in the instruction (marked with an `*` in the instruction). The position of the external axes are not used.

`ToPoint`

Data type: `robtarget`

The destination point of the robot and external axes. It is defined as a named position or stored directly in the instruction (marked with an `*` in the instruction).

`[\ID]`

Synchronization id

Data type: `identno`

The argument `[\ID]` is mandatory in `MultiMove` systems, if the movement is synchronized or coordinated synchronized. This argument is not allowed in any other case. The specified id number must be the same in all the cooperating program tasks. By using the id number the movements are not mixed up at the runtime.

`Speed`

Data type: `speeddata`

The speed data that applies to movements. Speed data defines the velocity of the TCP, the tool reorientation, and external axes.

`[\T]`

Time

Data type: `num`

This argument is used to specify the total time in seconds during which the robot moves. It is substituted for the corresponding speed data. The speed data is computed under the assumption that the speed is constant during the movement. If the robot cannot keep this speed during the whole movement, for example, when

Continues on next page

the movement starts from a finepoint or ends in a finepoint, the actual movement time will be larger than the programmed time.

Trigg_1

Data type: triggdata

Variable that refers to trigger conditions and trigger activity defined earlier in the program using the instructions TriggIO, TriggEquip, TriggInt, TriggCheckIO, TriggSpeed, or TriggRampAO.

TriggArray

Trigg Data Array Parameter

Data type: triggdata

Array variable that refers to trigger conditions and trigger activity defined earlier in the program using the instructions TriggIO, TriggEquip, TriggInt, TriggSpeed, TriggCheckIO, or TriggRampAO.

The limitation is 25 elements in the array and 1 to 25 defined trigger conditions must be defined.

It is not possible to use the optional arguments T2, T3, T4, T5, T6, T7, or T8 at the same time as the TriggArray argument is used.

[\T2]

Trigg 2

Data type: triggdata

Variable that refers to trigger conditions and trigger activity defined earlier in the program using the instructions TriggIO, TriggEquip, TriggInt, TriggCheckIO, TriggSpeed, or TriggRampAO.

[\T3]

Trigg 3

Data type: triggdata

Variable that refers to trigger conditions and trigger activity defined earlier in the program using the instructions TriggIO, TriggEquip, TriggInt, TriggCheckIO, TriggSpeed, or TriggRampAO.

[\T4]

Trigg 4

Data type: triggdata

Variable that refers to trigger conditions and trigger activity defined earlier in the program using the instructions TriggIO, TriggEquip, TriggInt, TriggCheckIO, TriggSpeed, or TriggRampAO.

[\T5]

Trigg 5

Data type: triggdata

Variable that refers to trigger conditions and trigger activity defined earlier in the program using the instructions TriggIO, TriggEquip, TriggInt, TriggCheckIO, TriggSpeed, or TriggRampAO.

Continues on next page

1 Instructions

1.309 TriggC - Circular robot movement with events

RobotWare Base

Continued

[\T6]

Trigg 6

Data type: `triggdata`

Variable that refers to trigger conditions and trigger activity defined earlier in the program using the instructions `TriggIO`, `TriggEquip`, `TriggInt`, `TriggCheckIO`, `TriggSpeed`, or `TriggRampAO`.

[\T7]

Trigg 7

Data type: `triggdata`

Variable that refers to trigger conditions and trigger activity defined earlier in the program using the instructions `TriggIO`, `TriggEquip`, `TriggInt`, `TriggCheckIO`, `TriggSpeed`, or `TriggRampAO`.

[\T8]

Trigg 8

Data type: `triggdata`

Variable that refers to trigger conditions and trigger activity defined earlier in the program using the instructions `TriggIO`, `TriggEquip`, `TriggInt`, `TriggCheckIO`, `TriggSpeed`, or `TriggRampAO`.

Zone

Data type: `zonedata`

Zone data for the movement. Zone data describes the size of the generated corner path.

[\Inpos]

In position

Data type: `stoppoint data`

This argument is used to specify the convergence criteria for the position of the robot's TCP in the stop point. The stop point data substitutes the zone specified in the `Zone` parameter.

Tool

Data type: `tooldata`

The tool in use when the robot moves. The tool center point is the point that is moved to the specified destination point.

[\WObj]

Work Object

Data type: `wobjdata`

The work object (object coordinate system) to which the robot position in the instruction is related.

This argument can be omitted and if it is then the position is related to the world coordinate system. If, on the other hand, a stationary TCP or coordinated external

Continues on next page

axes are used this argument must be specified in order for a circle relative to the work object to be executed.

[\Corr]

Correction

Data type: `switch`

Correction data written to a corrections entry by the instruction `CorrWrite` will be added to the path and destination position if this argument is present.

The RobotWare option *Path Offset* is required when using this argument.

[\TLoad]

Total load

Data type: `loaddata`

The `\TLoad` argument describes the total load used in the movement. The total load is the tool load together with the payload that the tool is carrying. If the `\TLoad` argument is used, then the `loaddata` in the current `tooldata` is not considered.

If the `\TLoad` argument is set to `load0`, then the `\TLoad` argument is not considered and the `loaddata` in the current `tooldata` is used instead.

To be able to use the `\TLoad` argument it is necessary to set the value of the system parameter `ModalPayLoadMode` to 0. If `ModalPayLoadMode` is set to 0, it is no longer possible to use the instruction `GripLoad`.

The total load can be identified with the service routine `LoadIdentify`. If the system parameter `ModalPayLoadMode` is set to 0, the operator has the possibility to copy the `loaddata` from the tool to an existing or new `loaddata` persistent variable when running the service routine.

It is possible to test run the program without any payload by using a digital input signal connected to the system input `SimMode` (Simulated Mode). If the digital input signal is set to 1, the `loaddata` in the optional argument `\TLoad` is not considered, and the `loaddata` in the current `tooldata` is used instead.



Note

The default functionality to handle payload is to use the instruction `GripLoad`. Therefore the default value of the system parameter `ModalPayLoadMode` is 1.

Program execution

See the instruction `MoveC` for information about circular movement.

As the trigger conditions are fulfilled when the robot is positioned closer and closer to the end point, the defined trigger activities are carried out. The trigger conditions are fulfilled either at a certain distance before the end point of the instruction, or at a certain distance after the start point of the instruction, or at a certain point in time (limited to a short time) before the end point of the instruction.

During stepping the execution forward, the I/O activities are carried out but the interrupt routines are not run. During stepping the execution backward, no trigger activities at all are carried out.

Continues on next page

1 Instructions

1.309 TriggC - Circular robot movement with events

RobotWare Base

Continued

Error handling

The following recoverable errors are generated and can be handled in an error handler. The system variable `ERRNO` will be set to:

Name	Cause of error
<code>ERR_AO_LIM</code>	The programmed <code>ScaleValue</code> argument for the specified analog output signal <code>AOp</code> in some of the connected <code>TriggSpeed</code> instructions result in out of limit for the analog signal together with the programmed <code>Speed</code> in this instruction.
<code>ERR_DIPLAG_LIM</code>	The programmed <code>DipLag</code> argument in some of the connected <code>TriggSpeed</code> instructions is too big in relation to the used <code>Event Preset Time</code> in <code>System Parameters</code> .
<code>ERR_NORUNUNIT</code>	There is no contact with the I/O device when entering instruction and the used <code>triggdata</code> depends on a running I/O device, i.e. a signal is used in the <code>triggdata</code> .
<code>ERR_CONC_MAX</code>	The number of movement instructions in succession using argument <code>\Conc</code> has been exceeded.

More examples

More examples of how to use the instruction `TriggC` are illustrated below.

Example 1

```
VAR intnum intnol;  
VAR triggdata trigg1;  
...  
PROC main()  
...  
CONNECT intnol WITH trap1;  
TriggInt trigg1, 0.1 \Time, intnol;  
...  
TriggC p1, p2, v500, trigg1, fine, gun1;  
TriggC p3, p4, v500, trigg1, fine, gun1;  
...  
IDelete intnol;
```

The interrupt routine `trap1` is run when the work point is at a position 0.1 s before the point `p2` or `p4` respectively.

Example 2

```
VAR num Distance:=0;  
VAR triggdata trigg_array{25};  
VAR signaldo myaliassignaldo;  
VAR string signalname;  
...  
PROC main()  
...  
FOR i FROM 1 TO 25 DO  
  signalname:="do";  
  signalname:=signalname+ValToStr(i);  
  AliasIO signalname, myaliassignaldo;  
  TriggEquip trigg_array{i}, Distance \Start, 0  
    \DOP:=myaliassignaldo, SetValue:=1;
```

Continues on next page

```

        Distance:=Distance+10;
    ENDFOR
    TriggC p1, p2, v500, trigg_array, z30, tool2;
    MoveC p3, p4, v500, z30, tool2;
    ...

```

The digital output signals do1 to do25 is set during the movement to p2. The distance between the signal settings is 10 mm.

Limitations

General limitations according to instruction MoveC.

If the current start point deviates from the usual point so that the total positioning length of the instruction TriggC is shorter than usual then it may happen that several or all of the trigger conditions are fulfilled immediately and at the same position. In such cases, the sequence in which the trigger activities are carried out will be undefined. The program logic in the user program may not be based on a normal sequence of trigger activities for an “incomplete movement”.



WARNING

The instruction TriggC should never be started from the beginning with the robot in position after the circle point. Otherwise, the robot will not take the programmed path (positioning around the circular path in another direction compared to that which is programmed).

TriggC cannot be executed in an UNDO handler or RAPID routine connected to any of the following special system events: PowerOn, Stop, QStop, Restart, Reset or Step.

Syntax

```

TriggC
[ '\ ' Conc ', ' ]
[ CirPoint ' := ' ] < expression (IN) of robtargt > ', '
[ ToPoint ' := ' ] < expression (IN) of robtargt > ', '
[ '\ ' ID ' := ' < expression (IN) of identno > ] ', '
[ Speed ' := ' ] < expression (IN) of speeddata >
[ '\ ' T ' := ' < expression (IN) of num > ] ', '
[ Trigg_1 ' := ' ] < variable (VAR) of triggdata >
| [ TriggArray ' := ' ] < array variable {*} (VAR) of triggdata >
[ '\ ' T2 ' := ' < variable (VAR) of triggdata > ]
[ '\ ' T3 ' := ' < variable (VAR) of triggdata > ]
[ '\ ' T4 ' := ' < variable (VAR) of triggdata > ]
[ '\ ' T5 ' := ' < variable (VAR) of triggdata > ]
[ '\ ' T6 ' := ' < variable (VAR) of triggdata > ]
[ '\ ' T7 ' := ' < variable (VAR) of triggdata > ]
[ '\ ' T8 ' := ' < variable (VAR) of triggdata > ] ', '
[ Zone ' := ' ] < expression (IN) of zonedata >
[ '\ ' Inpos ' := ' < expression (IN) of stoppointdata > ] ', '
[ Tool ' := ' ] < persistent (PERS) of tooldata >
[ '\ ' WObj ' := ' < persistent (PERS) of wobjdata > ]

```

Continues on next page

1 Instructions

1.309 TriggC - Circular robot movement with events

RobotWare Base

Continued

```
[ '\ ' Corr ]
[ '\ ' TLoad ' := ' < persistent (PERS) of loaddata > ] ';'

```

Related information

For information about	See
Linear movement with triggers	TriggL - Linear robot movements with events on page 935
Joint movement with triggers	TriggJ - Axis-wise robot movements with events on page 927
Move the robot circularly	MoveC - Moves the robot circularly on page 402
Definition of triggers	TriggIO - Define a fixed position or time I/O event near a stop point on page 921 TriggEquip - Define a fixed position and time I/O event on the path on page 910 TriggInt - Defines a position related interrupt on page 916 TriggCheckIO - Defines I/O check at a fixed position on page 900 TriggRampAO - Define a fixed position ramp AO event on the path on page 958 TriggSpeed - Defines TCP speed proportional analog output with fixed position-time scale event on page 965
Handling triggdata	triggdata - Positioning events, trigg on page 1785 TriggDataReset - Reset the content in a triggdata variable on page 908 TriggDataCopy - Copy the content in a triggdata variable on page 906 TriggDataValid - Check if the content in a triggdata variable is valid on page 1528
Writes to a corrections entry	CorrWrite - Writes to a correction generator on page 180
Circular movement	<i>Technical reference manual - RAPID Overview</i>
Definition of load	loaddata - Load data on page 1682
Definition of velocity	speeddata - Speed data on page 1751
Definition of stop point data	stoppointdata - Stop point data on page 1755
Definition of tools	tooldata - Tool data on page 1776
Definition of work objects	wobjdata - Work object data on page 1803
Definition of zone data	zonedata - Zone data on page 1811
Motion in general	<i>Technical reference manual - RAPID Overview</i>
Example of how to use TLoad, Total Load.	MoveL - Moves the robot linearly on page 458
Defining the payload for a robot	GripLoad - Defines the payload for a robot on page 243
LoadIdentify, load identification service routine	<i>Operating manual - IRC5 with FlexPendant</i>
System input signal SimMode for running the robot in simulated mode without payload.	<i>Technical reference manual - System parameters</i>

Continues on next page

For information about	See
System parameter <i>ModalPayload-Mode</i> for activating and deactivating payload.	<i>Technical reference manual - System parameters</i>
<i>Path Offset</i>	<i>Application manual - Controller software IRC5</i>

1 Instructions

1.310 TriggCheckIO - Defines I/O check at a fixed position

RobotWare Base

1.310 TriggCheckIO - Defines I/O check at a fixed position

Usage

`TriggCheckIO` is used to define conditions for testing the value of a digital, a group of digital, or an analog input or output signal at a fixed position along the robot's movement path. If the condition is fulfilled then there will be no specific action. But if it is not then an interrupt routine will be run after the robot has optionally stopped on path as fast as possible.

To obtain a fixed position I/O check, `TriggCheckIO` compensates for the lag in the control system (lag between servo and robot).

The data defined is used for implementation in one or more subsequent `TriggL`, `TriggC`, or `TriggJ` instructions.

This instruction can only be used in the main task `T_ROB1` or, if in a *MultiMove* system, in Motion tasks.

Basic examples

The following example illustrates the instruction `TriggCheckIO`:

See also [More examples on page 903](#).

Example 1

```
VAR trigdata checkgrip;
VAR intnum intnol;

PROC main()
  CONNECT intnol WITH trap1;
  TriggCheckIO checkgrip, 100, airok, EQ, 1, intnol;

  TriggL p1, v500, checkgrip, z50, grip1;
```

The digital input signal `airok` is checked to have the value 1 when the TCP is 100 mm before the point `p1`. If it is set then normal execution of the program continues. If it is not set then the interrupt routine `trap1` is run.

The figure shows an example of fixed position I/O check.

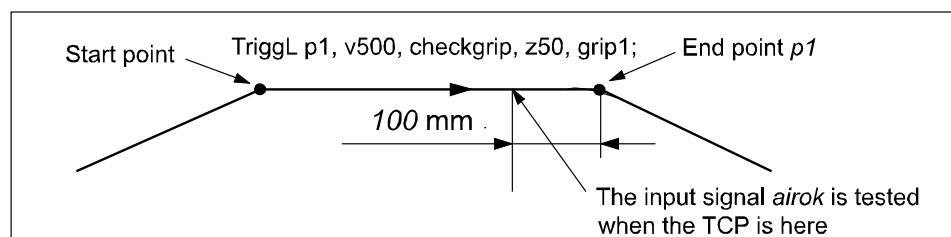

xx0500002254

Arguments

```
TriggCheckIO TriggData Distance [\Start] | [\Next] | [\Time] Signal
              Relation CheckValue | CheckDvalue [\StopMove] Interrupt
              [ \Inhib] [ \Mode]
```

Continues on next page

TriggData

Data type: `triggdata`

Variable for storing the `triggdata` returned from this instruction. These `triggdata` are then used in the subsequent `TriggL`, `TriggC`, or `TriggJ` instructions.

Distance

Data type: `num`

Defines the position on the path where the I/O check shall occur.

Specified as the distance in mm (positive value) from the end point of the movement path (applicable if the argument `\Start` or `\Time` is not set).

See [Program execution on page 902](#) for further details.

[`\Start`]

Data type: `switch`

Used when the distance for the argument `Distance` starts at the movement start point instead of the end point.

[`\Next`]

Data type: `switch`

Used when the distance for the argument `Distance` is forward towards the next programmed point. If the `Distance` is longer than the distance to the next fine point, the event will be executed at the fine point.

[`\Time`]

Data type: `switch`

Used when the value specified for the argument `Distance` is in fact a time in seconds (positive value) instead of a distance.

Fixed position I/O in time can only be used for short times (< 0.5 s) before the robot reaches the end point of the instruction. See the section *Limitations* for more details.

Signal

Data type: `signalxx`

The name of the signal that will be tested. May be any type of I/O signal.

Relation

Data type: `opnum`

Defines how to compare the actual value of the signal with the one defined by the argument `CheckValue`. See `opnum` data type for the list of the predefined constants to be used.

CheckValue

Data type: `num`

Value to which the actual value of the input or output signal is to be compared (within the allowed range for the current signal). If the signal is a digital signal, it must be an integer value.

If the signal is a digital group signal, the permitted value is dependent on the number of signals in the group. Max value that can be used in the `CheckValue`

Continues on next page

1 Instructions

1.310 TriggCheckIO - Defines I/O check at a fixed position

RobotWare Base

Continued

argument is 8388608, and that is the value a 23 bit digital group signal can have as maximum value (see ranges for `num`).

`CheckDvalue`

Data type: `dnum`

Value to which the actual value of the input or output signal is to be compared (within the allowed range for the current signal). If the signal is a digital signal, it must be an integer value.

If the signal is a digital group signal, the permitted value is dependent on the number of signals in the group. The maximal amount of signal bits a digital group signal can have is 32. With a `dnum` variable it is possible to cover the value range 0-4294967295, which is the value range a 32 bits digital signal can have.

[`\StopMove`]

Data type: `switch`

Specifies that if the condition is not fulfilled then the robot will stop on path as quickly as possible before the interrupt routine is run.

`Interrupt`

Data type: `intnum`

Variable used to identify the interrupt routine to run.

[`\Inhib`]

Inhibit

Data type: `bool`

The name of a persistent variable flag for inhibiting the execution of the interrupt routine.

If this optional argument is used and the actual value of the specified flag is TRUE at the position-time for I/O check, the check will not be performed.

[`\Mode`]

Data type: `triggmode`

Is used to specify different action modes when defining triggers.

Program execution

When running the instruction `TriggCheckIO`, the trigger condition is stored in a specified variable for the argument `TriggData`.

Afterwards, when one of the instructions `TriggL`, `TriggC`, or `TriggJ` is executed, the following are applicable with regard to the definitions in `TriggCheckIO`:

The table describes distance specified in the argument `Distance`:

Linear movement	The straight line distance
Circular movement	The circle arc length
Non-linear movement	The approximate arc length along the path (to obtain adequate accuracy, the distance should not exceed one half of the arc length).

Continues on next page

The figure shows fixed position I/O check on a corner path.

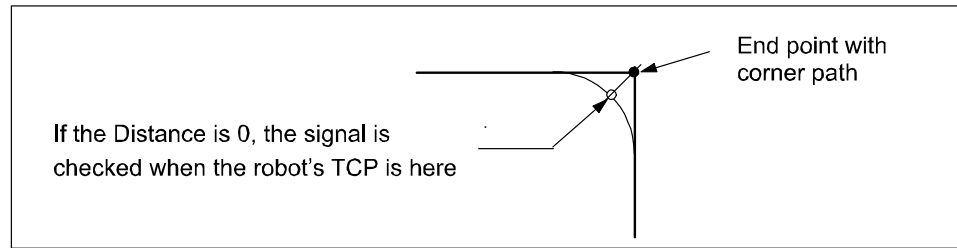

xx0500002256

The fixed position I/O check will be done when the start point (end point) is passed if the specified distance from the end point (start point) is not within the length of movement of the current instruction (`TriggL...`).

When the TCP of the robot is at specified place on the path, the following I/O check will be done by the system:

- Read the value of the I/O signal.
- Compare the read value with `CheckValue` according specified `Relation`.
- If the comparison is `TRUE` then nothing more is done.
- If the comparison is `FALSE` then following is done:
- If optional parameter `\StopMove` is present then the robot is stopped on the path as quickly as possible.
- Generate and execute the specified trap routine.

Error handling

The following recoverable errors are generated and can be handled in an error handler. The system variable `ERRNO` will be set to:

Name	Cause of error
<code>ERR_AO_LIM</code>	The programmed <code>CheckValue</code> or <code>CheckDvalue</code> argument for the specified analog output signal <code>Signal</code> is outside limits.
<code>ERR_GO_LIM</code>	The programmed <code>CheckValue</code> or <code>CheckDvalue</code> argument for the specified digital group output signal <code>Signal</code> is outside limits.
<code>ERR_NO_ALIASIO_DEF</code>	The signal variable is a variable declared in <code>RAPID</code> . It has not been connected to an I/O signal defined in the I/O configuration with instruction <code>AliasIO</code> .

More examples

More examples of how to use the instruction `TriggCheckIO` are illustrated below.

Example 1

```

VAR triggdata checkgate;
VAR intnum gateclosed;

PROC main()
  CONNECT gateclosed WITH waitgate;
  TriggCheckIO checkgate,150, gatedi, EQ, 1 \StopMove, gateclosed;

```

Continues on next page

1 Instructions

1.310 TriggCheckIO - Defines I/O check at a fixed position

RobotWare Base

Continued

```
TriggL p1, v600, checkgate, z50, gripl;  
...  
TRAP waitgate  
! Block movement  
StopMove;  
! log some information  
...  
! Wait until signal is set  
WaitDI gatedi,1;  
! Unlock block, and resume movement  
StartMove;  
ENDTRAP
```

The gate for the next workpiece operation is checked to be open (digital input signal `gatedi` is checked to have the value 1) when the TCP is 150 mm before the point `p1`. If it is open then the robot will move on to `p1` and continue. If it is not open then the robot is stopped on path and the interrupt routine `waitgate` is run. This interrupt blocks further movements, log some information and typically waits for the conditions to be OK to execute a `StartMove` instruction to restart the interrupted path.

Limitations

I/O checks with distance (without the argument `\Time`) is intended for flying points (corner path). I/O checks with distance, using stop points, results in worse accuracy than specified below.

I/O checks with time (with the argument `\Time`) is intended for stop points. I/O checks with time, using flying points, results in worse accuracy than specified below.

I/O checks with time can only be specified from the end point of the movement. This time cannot exceed the current braking time of the robot, which is max. approximately 0.5 s (typical values at speed 500 mm/s for IRB 2400 is 150 ms, and for IRB 6400 is 250 ms). If the specified time is greater than the current braking time then the I/O check will be generated anyway but not until braking is started (later than specified). The whole of the movement time for the current movement can be utilized during small and fast movements.

Typical absolute accuracy values for testing of digital inputs +/- 5 ms. Typical repeat accuracy values for testing of digital inputs +/- 2 ms.

`TriggCheckIO` cannot be executed in an UNDO handler or RAPID routine connected to any of the following special system events: `PowerOn`, `Stop`, `QStop`, `Restart`, `Reset` or `Step`.

Syntax

```
TriggCheckIO  
[ TriggData ':= ' ] < variable (VAR) of triggdata> ', '  
[ Distance ':= ' ] < expression (IN) of num>  
[ '\ ' Start ] | [ '\ ' Next ] | [ '\ ' Time ] ', '  
[ Signal ':= ' ] < variable (VAR) of anytype> ', '  
[ Relation ':= ' ] < expression (IN) of opnum> ', '  
[ CheckValue ':= ' ] < expression (IN) of num>
```

Continues on next page

1.310 TriggCheckIO - Defines I/O check at a fixed position

RobotWare Base

Continued

```

| [ CheckDvalue ':=' ] < expression (IN) of dnum>
[ '\ StopMove ] ','
[ Interrupt ':=' ] < variable(VAR) of intnum>
[ '\ Inhib ':=' < persistent (PERS) of bool> ]
[ '\ Mode ':=' < expression (IN) of triggmode> ] ';'

```

Related information

For information about	See
Use of triggers	TriggL - Linear robot movements with events on page 935 TriggC - Circular robot movement with events on page 891 TriggJ - Axis-wise robot movements with events on page 927
Definition of position-time I/O event	TriggIO - Define a fixed position or time I/O event near a stop point on page 921 TriggEquip - Define a fixed position and time I/O event on the path on page 910
Definition of position related interrupts	TriggInt - Defines a position related interrupt on page 916
Storage of trigg data	triggdata - Positioning events, trigg on page 1785
Defining different trigg action modes	triggmode - Trigg action mode on page 1791
Definition of comparison operators	opnum - Comparison operator on page 1701

1 Instructions

1.311 TriggDataCopy - Copy the content in a triggdata variable

RobotWare Base

1.311 TriggDataCopy - Copy the content in a triggdata variable

Usage

TriggDataCopy is used to copy the content in a triggdata variable.

Basic examples

The following example illustrates the instruction TriggDataCopy.

Example 1

```
VAR triggdata trigg_array{25};
...
PROC MyTriggProcL(robtarget myrobt, \VAR triggdata T1 \VAR triggdata
  T2 \VAR triggdata T3)
  VAR num triggcnt:=2;
  ! Reset entire trigg_array array before using it
  FOR i FROM 1 TO 25 DO
    TriggDataReset trigg_array{i};
  ENDFOR
  TriggEquip trigg_array{1}, 10 \Start, 0 \Dop:=do1, SetValue:=1;
  TriggEquip trigg_array{2}, 40 \Start, 0 \Dop:=do2, SetValue:=1;
  ! Check if optional argument is present,
  ! and if any trigger condition has been setup in T1
  IF Present(T1) AND TriggDataValid(T1) THEN
    ! Copy actual trigger condition to trigg_array
    TriggDataCopy T1, trigg_array{triggcnt};
    Incr triggcnt;
  ENDIF
  IF Present(T2) AND TriggDataValid(T2) THEN
    Incr triggcnt;
    TriggDataCopy T2, trigg_array{triggcnt};
  ENDIF
  IF Present(T3) AND TriggDataValid(T3) THEN
    Incr triggcnt;
    TriggDataCopy T3, trigg_array{triggcnt};
  ENDIF
  TriggL p1, v500, trigg_array, z30, tool2;
  ...
```

The procedure MyTriggProcL above uses the TriggDataCopy instruction to copy the triggdata optional arguments to right place in the triggdata array that is used in the TriggL instruction.

Arguments

TriggDataCopy Source Destination

Source

Data type: triggdata

The triggdata variable to copy from.

Destination

Data type: triggdata

Continues on next page

The `triggdata` variable to copy to.

Program execution

The `TriggDataCopy` instruction is used to copy data from one `triggdata` variable to another `triggdata` variable. This instruction can be useful when working with `triggdata` array variables.

Limitations

`TriggDataCopy` cannot be executed in an UNDO handler or RAPID routine connected to any of the following special system events: PowerOn, Stop, QStop, Restart, Reset or Step.

Syntax

```
TriggDataCopy
  [Source ':= ' ] < variable (VAR) of triggdata > ', '
  [Destination ':= ' ] < variable (VAR) of triggdata > ';'

```

Related information

For information about	See
Linear movement with triggers	TriggL - Linear robot movements with events on page 935
Joint movement with triggers	TriggJ - Axis-wise robot movements with events on page 927
Circular movement with triggers	TriggC - Circular robot movement with events on page 891
Definition of triggers	TriggIO - Define a fixed position or time I/O event near a stop point on page 921 TriggEquip - Define a fixed position and time I/O event on the path on page 910 TriggInt - Defines a position related interrupt on page 916 TriggCheckIO - Defines I/O check at a fixed position on page 900 TriggRampAO - Define a fixed position ramp AO event on the path on page 958 TriggSpeed - Defines TCP speed proportional analog output with fixed position-time scale event on page 965
Handling <code>triggdata</code>	triggdata - Positioning events, trigg on page 1785 TriggDataReset - Reset the content in a triggdata variable on page 908 TriggDataValid - Check if the content in a triggdata variable is valid on page 1528

1 Instructions

1.312 TriggDataReset - Reset the content in a triggdata variable

RobotWare Base

1.312 TriggDataReset - Reset the content in a triggdata variable

Usage

TriggDataReset is used to reset the content in a triggdata variable.

Basic examples

The following example illustrates the instruction TriggDataReset.

Example 1

```
VAR triggdata trigg_array{25};
...
PROC MyTriggProcL(robtarget myrobt, \VAR triggdata T1 \VAR triggdata
  T2 \VAR triggdata T3)
  VAR num triggcnt:=2;
  ! Reset entire trigg_array array before using it
  FOR i FROM 1 TO 25 DO
    TriggDataReset trigg_array{i};
  ENDFOR
  TriggEquip trigg_array{1}, 10 \Start, 0 \Dop:=do1, SetValue:=1;
  TriggEquip trigg_array{2}, 40 \Start, 0 \Dop:=do2, SetValue:=1;
  ! Check if optional argument is present,
  ! and if any trigger condition has been setup in T1
  IF Present(T1) AND TriggDataValid(T1) THEN
    ! Copy actual trigger condition to trigg_array
    TriggDataCopy trigg_array{triggcnt}, T1;
    Incr triggcnt;
  ENDIF
  IF Present(T2) AND TriggDataValid(T2) THEN
    Incr triggcnt;
    TriggDataCopy trigg_array{triggcnt}, T2;
  ENDIF
  IF Present(T3) AND TriggDataValid(T3) THEN
    Incr triggcnt;
    TriggDataCopy trigg_array{triggcnt}, T3;
  ENDIF
  TriggL p1, v500, trigg_array, z30, tool2;
  ...
```

The procedure MyTriggProcL above uses the TriggDataReset instruction to reset the triggdata array before it is used.

Arguments

TriggDataReset TriggData

TriggData

Data type: triggdata

The triggdata variable to reset.

Continues on next page

Program execution

The `TriggDataReset` instruction is used to remove any trigger condition previously used in a `triggdata` variable. This instruction can be useful when working with `triggdata` array variables.

Limitations

`TriggDataReset` cannot be executed in an UNDO handler or RAPID routine connected to any of the following special system events: PowerOn, Stop, QStop, Restart, Reset or Step.

Syntax

```
TriggDataReset
  [TriggData ':='] < variable (VAR) of triggdata > ';'

```

Related information

For information about	See
Linear movement with triggers	TriggL - Linear robot movements with events on page 935
Joint movement with triggers	TriggJ - Axis-wise robot movements with events on page 927
Circular movement with triggers	TriggC - Circular robot movement with events on page 891
Definition of triggers	TriggIO - Define a fixed position or time I/O event near a stop point on page 921 TriggEquip - Define a fixed position and time I/O event on the path on page 910 TriggInt - Defines a position related interrupt on page 916 TriggCheckIO - Defines I/O check at a fixed position on page 900 TriggRampAO - Define a fixed position ramp AO event on the path on page 958 TriggSpeed - Defines TCP speed proportional analog output with fixed position-time scale event on page 965
Handling <code>triggdata</code>	triggdata - Positioning events, trigg on page 1785 TriggDataCopy - Copy the content in a triggdata variable on page 906 TriggDataValid - Check if the content in a triggdata variable is valid on page 1528

1 Instructions

1.313 TriggEquip - Define a fixed position and time I/O event on the path *RobotWare Base*

1.313 TriggEquip - Define a fixed position and time I/O event on the path

Usage

`TriggEquip` (*Trigg Equipment*) is used to define conditions and actions for setting a digital, a group of digital, or an analog output signal at a fixed position along the robot's movement path with possibility to do time compensation for the lag in the external equipment.

`TriggIO` (not `TriggEquip`) should always be used if there is need for good accuracy of the I/O settings near a stop point.

The data defined is used for implementation in one or more subsequent `TriggL`, `TriggC`, or `TriggJ` instructions.

This instruction can only be used in the main task `T_ROB1` or, if in a *MultiMove* system, in Motion tasks.

Basic examples

The following example illustrates the instruction `TriggEquip`:
See also [More examples on page 914](#).

Example 1

```
VAR triggdata gunon;  
...  
TriggEquip gunon, 10, 0.1 \DOp:=gun, 1;  
TriggL p1, v500, gunon, z50, gun1;
```

The tool `gun1` starts to open when its TCP is 0,1 s before the fictitious point `p2` (10 mm before point `p1`). The gun is full open when TCP reach point `p2`.

The figure shows an example of a fixed position time I/O event.

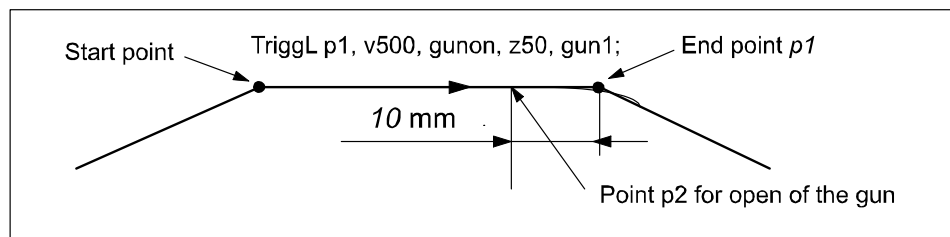

xx0500002260

Arguments

```
TriggEquip TriggData Distance [\Start] | [\Next] EquipLag [\DOp]  
| [\GOp] | [\AOp] | [\ProcID] SetValue | SetDvalue [\Inhib]  
[\InhibSetValue] [\Mode]
```

TriggData

Data type: `triggdata`

Variable for storing the `triggdata` returned from this instruction. These `triggdata` are then used in the subsequent `TriggL`, `TriggC`, or `TriggJ` instructions.

Continues on next page

Distance

Data type: num

Defines the position on the path where the I/O equipment event shall occur.

Specified as the distance in mm (positive value) from the end point of the movement path towards the start point (applicable if the arguments `\Start` and `\Next` are not set).

See [Program execution on page 913](#) for further details.

[`\Start`]

Data type: switch

Used when the distance for the argument `Distance` starts at the movement start point instead of the end point.

[`\Next`]

Data type: switch

Used when the distance for the argument `Distance` is forward towards the next programmed point. If the `Distance` is longer than the distance to the next fine point, the event will be executed at the fine point.

EquipLag

Equipment Lag

Data type: num

Specify the lag for the external equipment in s.

For compensation of external equipment lag, use a positive argument value. Positive argument value means that the I/O signal is set by the robot system at a specified time before the TCP physically reaches the specified distance in relation to the movement start or end point.

Negative argument value means that the I/O signal is set by the robot system at a specified time after that the TCP has physically passed the specified distance in relation to the movement start or end point.

The figure shows use of argument `EquipLag`.

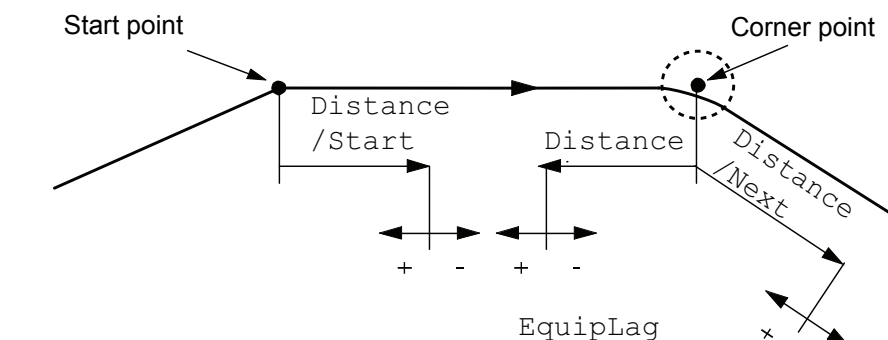

xx0500002262

[`\DOP`]

Digital Output

Continues on next page

1 Instructions

1.313 TriggEquip - Define a fixed position and time I/O event on the path

RobotWare Base

Continued

Data type: `signaldo`

The name of the signal when a digital output signal shall be changed.

[`\GOP`]

Group Output

Data type: `signalgo`

The name of the signal when a group of digital output signals shall be changed.

[`\AOp`]

Analog Output

Data type: `signalao`

The name of the signal when an analog output signal shall be changed.

[`\ProcID`]

Process Identity

Data type: `num`

Not implemented for customer use.

(The identity of the IPM process to receive the event. The selector is specified in the argument `SetValue`.)

`SetValue`

Data type: `num`

The desired value of the signal (within the allowed range for the current signal). If the signal is a digital signal, it must be an integer value. If the signal is a digital group signal, the permitted value is dependent on the number of signals in the group. Max value that can be used in the `SetValue` argument is 8388608, and that is the value a 23 bit digital group signal can have as maximum value (see ranges for `num`).

`SetDvalue`

Data type: `dnum`

The desired value of the signal (within the allowed range for the current signal). If the signal is a digital signal, it must be an integer value. If the signal is a digital group signal, the permitted value is dependent on the number of signals in the group. The maximal amount of signal bits a digital group signal can have is 32. With a `dnum` variable it is possible to cover the value range 0-4294967295, which is the value range a 32 bits digital signal can have.

[`\Inhib`]

Inhibit

Data type: `bool`

The name of a persistent variable flag for inhibiting the setting of the signal at runtime.

If this optional argument is used and the actual value of the specified flag is TRUE at the position-time for setting of the signal then the specified signal (`DOP`, `GOP` or `AOp`) will be set to 0 instead of a specified value.

Continues on next page

[\InhibSetValue]

InhibitSetValue**Data type:** bool, num or dnum

The name of a persistent variable of the data type bool, num or dnum or any alias of those three base data types.

This optional argument can only be used together with optional argument Inhib.

If this optional argument is used and the value of the persistent variable flag used in optional argument Inhib is TRUE at the position-time for setting the signal, the value of the persistent variable used in optional argument InhibitSetValue is read and the value is used for setting of the DOp, GOp or AOp signal.

If using a boolean persistent variable, the value TRUE is translated to value 1, and FALSE is translated to value 0.

[\Mode]

Data type: trigemode

Is used to specify different action modes when defining triggers.

Program execution

When running the instruction TriggEquip, the trigger condition is stored in the specified variable for the argument TriggData.

Afterwards, when one of the instructions TriggL, TriggC, or TriggJ is executed then the following are applicable with regard to the definitions in TriggEquip:

The table describes the distance specified in the argument Distance:

Linear movement	The straight line distance
Circular movement	The circle arc length
Non-linear movement	The approximate arc length along the path (to obtain adequate accuracy, the distance should not exceed one half of the arc length).

The figure shows fixed position time I/O on a corner path.

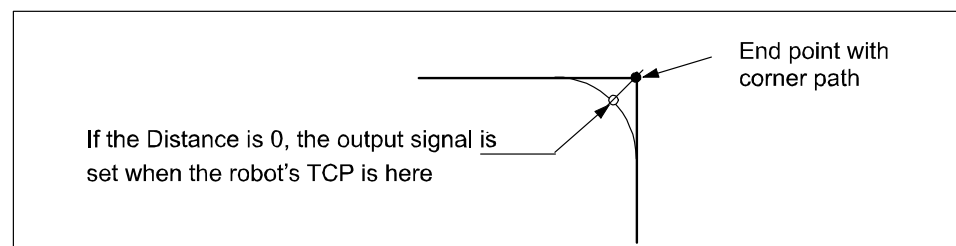

xx0500002263

The position-time related event will be generated when the start point (end point) is passed if the specified distance from the end point (start point) is not within the length of movement of the current instruction (TriggL...). With use of argument EquipLag with negative time (delay), the I/O signal can be set after the end point.

Continues on next page

1 Instructions

1.313 TriggEquip - Define a fixed position and time I/O event on the path

RobotWare Base

Continued

Error handling

The following recoverable errors are generated and can be handled in an error handler. The system variable `ERRNO` will be set to:

Name	Cause of error
<code>ERR_AO_LIM</code>	The programmed <code>SetValue</code> argument for the specified analog output signal <code>AOp</code> is out of limit.
<code>ERR_GO_LIM</code>	The programmed <code>SetValue</code> or <code>SetDvalue</code> argument for the specified digital group output signal <code>GOp</code> is out of limit.
<code>ERR_NO_ALIASIO_DEF</code>	The signal variable is a variable declared in RAPID. It has not been connected to an I/O signal defined in the I/O configuration with instruction <code>AliasIO</code> .

More examples

More examples of how to use the instruction `TriggEquip` are illustrated below.

Example 1

```
VAR triggdata glueflow;
...
TriggEquip glueflow, 1 \Start, 0.05 \AOp:=glue, 5.3;
MoveJ p1, v1000, z50, tool1;
TriggL p2, v500, glueflow, z50, tool1;
```

The analog output signal `glue` is set to the value 5.3 when the TCP passes a point located 1 mm after the start point `p1` with compensation for equipment lag 0.05 s.

Example 2

```
...
TriggL p3, v500, glueflow, z50, tool1;
```

The analog output signal `glue` is set once more to the value 5.3 when the TCP passes a point located 1 mm after the start point `p2`.

Limitations

I/O events with distance is intended for flying points (corner path). Using stop points will result in worse accuracy than specified below.

Regarding the accuracy for I/O events with distance and using flying points, the following is applicable when setting a digital output at a specified distance from the start point or end point in the instruction `TriggL` or `TriggC`:

- The accuracy specified below is valid when using a positive `EquipLag` that is less than 40 ms, which is equivalent to the lag in the robot servo without changing the system parameter *Event Preset Time*. The lag can vary between different robot types.
- The accuracy specified below is valid when using a positive `EquipLag` that is less than the configured *Event Preset Time* in the system parameters.
- The accuracy specified below is not valid when using a positive `EquipLag` that is larger than the configured *Event Preset Time* in the system parameters. In this case, an approximate method is used in which the dynamic limitations

Continues on next page

1.313 TriggEquip - Define a fixed position and time I/O event on the path RobotWare Base Continued

of the robot are not taken into consideration. Then `SingArea \Wrist` must be used to achieve an acceptable accuracy.

- The accuracy specified below is valid when using a negative `EquipLag`.

The typical absolute accuracy values for setting digital outputs is: ± 5 ms.

The typical repeat accuracy values for setting digital outputs is: ± 2 ms.

`TriggEquip` cannot be executed in an UNDO handler or RAPID routine connected to any of the following special system events: `PowerOn`, `Stop`, `QStop`, `Restart`, `Reset` or `Step`.

Syntax

```
TriggEquip
[ TriggData ':= ' ] < variable (VAR) of triggdata> ', '
[ Distance ':= ' ] < expression (IN) of num>
[ '\ ' Start ] | [ '\ ' Next ] ', '
[ EquipLag ':= ' ] < expression (IN) of num>
[ '\ ' DOp ':= ' < variable (VAR) of signaldo> ]
| [ '\ ' GOP ':= ' < variable (VAR) of signalgo> ]
| [ '\ ' AOp ':= ' < variable (VAR) of signalao> ]
| [ '\ ' ProcID ':= ' < expression (IN) of num> ] ', '
[ SetValue ':= ' ] < expression (IN) of num>
| [ SetDvalue ':= ' ] < expression (IN) of dnum> ', '
[ '\ ' Inhib ':= ' < persistent (PERS) of bool> ]
[ '\ ' InhibSetValue ':= ' < persistent (PERS) of anytype> ]
[ '\ ' Mode ':= ' < expression (IN) of triggmode> ] ';'

```

Related information

For information about	See
Use of triggers	TriggL - Linear robot movements with events on page 935 TriggC - Circular robot movement with events on page 891 TriggJ - Axis-wise robot movements with events on page 927
Definition of other triggs	TriggIO - Define a fixed position or time I/O event near a stop point on page 921 TriggInt - Defines a position related interrupt on page 916
Define I/O check at a fixed position	TriggCheckIO - Defines I/O check at a fixed position on page 900
Storage of trigg data	triggdata - Positioning events, trigg on page 1785
Defining different trigg action modes	triggmode - Trigg action mode on page 1791
Set of I/O	SetDO - Changes the value of a digital output signal on page 704 SetGO - Changes the value of a group of digital output signals on page 707 SetAO - Changes the value of an analog output signal on page 694
Configuration of Event preset time	Technical reference manual - System parameters

1 Instructions

1.314 TriggInt - Defines a position related interrupt *RobotWare Base*

1.314 TriggInt - Defines a position related interrupt

Usage

`TriggInt` is used to define conditions and actions for running an interrupt routine at a specified position on the robot's movement path.

The data defined is used for implementation in one or more subsequent `TriggL`, `TriggC`, or `TriggJ` instructions.

This instruction can only be used in the main task `T_ROB1` or, if in a `MultiMove System`, in Motion tasks.

Basic examples

The following example illustrates the instruction `TriggInt`:

Example 1

```
VAR intnum intnol;  
VAR triggdata trigg1;  
...  
PROC main()  
  CONNECT intnol WITH trap1;  
  TriggInt trigg1, 5, intnol;  
  ...  
  TriggL p1, v500, trigg1, z50, gun1;  
  TriggL p2, v500, trigg1, z50, gun1;  
  ...  
  IDelete intnol;
```

The interrupt routine `trap1` is run when the TCP is at a position 5mm before the point `p1` or `p2` respectively.

The figure shows an example of position related interrupt.

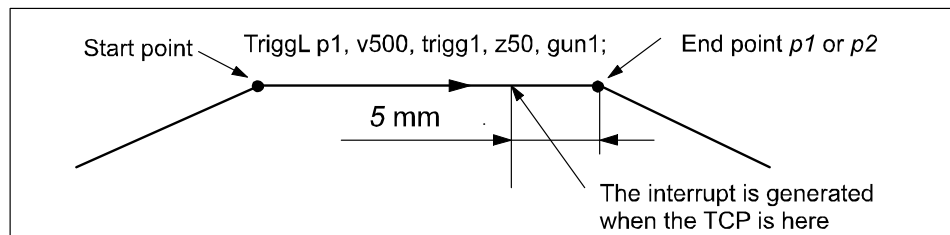

xx0500002251

Arguments

```
TriggInt TriggData Distance [\Start] | [\Next] | [\Time] Interrupt  
[\Inhib] [\Mode]
```

TriggData

Data type: `triggdata`

Variable for storing the `triggdata` returned from this instruction. These `triggdata` are then used in the subsequent `TriggL`, `TriggC`, or `TriggJ` instructions.

Continues on next page

Distance

Data type: num

Defines the position on the path where the interrupt shall be generated.

Specified as the distance in mm (positive value) from the end point of the movement path (applicable if the argument `\Start` or `\Time` is not set).

See [Program execution on page 917](#) for further details.

[`\Start`]

Data type: switch

Used when the distance for the argument `Distance` starts at the movement start point instead of the end point.

[`\Next`]

Data type: switch

Used when the distance for the argument `Distance` is forward towards the next programmed point. If the `Distance` is longer than the distance to the next fine point, the event will be executed at the fine point.

[`\Time`]

Data type: switch

Used when the value specified for the argument `Distance` is in fact a time in seconds (positive value) instead of a distance.

Fixed position I/O in time can only be used for short times (< 0.5 s) before the robot reaches the end point of the instruction. See the section *Limitations* for more details.

Interrupt

Data type: intnum

Variable used to identify an interrupt.

[`\Inhib`]

Inhibit

Data type: bool

The name of a persistent variable flag for inhibiting the execution of the interrupt routine.

If this optional argument is used and the actual value of the specified flag is TRUE at the position-time for interrupt execution, the interrupt will not be executed.

[`\Mode`]

Data type: trigemode

Is used to specify different action modes when defining triggers.

Program execution

When running the instruction `TriggInt`, data is stored in a specified variable for the argument `TriggData` and the interrupt that is specified in the variable for the argument `Interrupt` is activated.

Continues on next page

1 Instructions

1.314 TriggInt - Defines a position related interrupt

RobotWare Base

Continued

Afterwards, when one of the instructions `TriggL`, `TriggC`, or `TriggJ` is executed, the following are applicable with regard to the definitions in `TriggInt`:

The table describes the distance specified in the argument `Distance`:

Linear movement	The straight line distance
Circular movement	The circle arc length
Non-linear movement	The approximate arc length along the path (to obtain adequate accuracy, the distance should not exceed one half of the arc length).

The figure shows position related interrupt on a corner path.

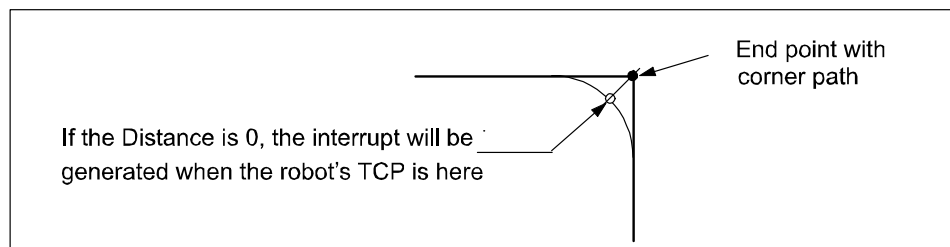

xx0500002253

The position related interrupt will be generated when the start point (end point) is passed if the specified distance from the end point (start point) is not within the length of movement of the current instruction (`TriggL...`).

The interrupt is considered to be a safe interrupt. A safe interrupt cannot be put in sleep with instruction `ISleep`. The safe interrupt event will be queued at program stop and stepwise execution, and when starting in continuous mode again, the interrupt will be executed. The only time a safe interrupt will be thrown is when the interrupt queue is full. Then an error will be reported. The interrupt will not survive program reset, e.g. PP to main.

More examples

More examples of how to use the instruction `TriggInt` are illustrated below.

Example 1

This example describes programming of the instructions that interact to generate position related interrupts:

```
VAR intnum intno2;  
VAR triggdata trigg2;
```

- Declaration of the variables `intno2` and `trigg2` (shall not be initiated).

```
CONNECT intno2 WITH trap2;
```

- Allocation of interrupt numbers that are stored in the variable `intno2`.
- The interrupt number is coupled to the interrupt routine `trap2`.

```
TriggInt trigg2, 0, intno2;
```

- The interrupt number in the variable `intno2` is flagged as used.
- The interrupt is activated.
- Defined trigger conditions and interrupt numbers are stored in the variable `trigg2`

Continues on next page

```
TriggL p1, v500, trigg2, z50, gun1;
```

- The robot is moved to the point `p1`.
- When the TCP reaches the point `p1` an interrupt is generated, and the interrupt routine `trap2` is run.

```
TriggL p2, v500, trigg2, z50, gun1;
```

- The robot is moved to the point `p2`.
- When the TCP reaches the point `p2`, an interrupt is generated and the interrupt routine `trap2` is run once more.

```
IDelete intno2;
```

- The interrupt number in the variable `intno2` is de-allocated.

Limitations

Interrupt events with distance (without the argument `\Time`) are intended for flying points (corner path). Interrupt events with distance, using stop points results in worse accuracy than specified below.

Interrupt events with time (with the argument `\Time`) are intended for stop points. Interrupt events with time, using flying points, result in worse accuracy than specified below. I/O events with time can only be specified from the end point of the movement. This time cannot exceed the current braking time of the robot, which is max. approximately 0.5 s (typical values at speed 500 mm/s for IRB 2400 is 150 ms, and for IRB 6400 is 250 ms). If the specified time is greater than the current braking time then the event will be generated anyhow but not until braking is started (later than specified). The whole of the movement time for the current movement can be utilized during small and fast movements.

Typical absolute accuracy values for generation of interrupts +/- 5 ms. Typical repeat accuracy values for generation of interrupts +/- 2 ms. Normally there is a delay of 2 to 30 ms between interrupt generation and response depending on the type of movement being performed at the time of the interrupt. See *Technical reference manual - RAPID Overview*.

To obtain the best accuracy when setting an output at a fixed position along the robot's path, use the instructions `TriggIO` or `TriggEquip` in preference to the instructions `TriggInt` with `SetDO/SetGO/SetAO` in an interrupt routine.

`TriggInt` cannot be executed in an UNDO handler or RAPID routine connected to any of the following special system events: `PowerOn`, `Stop`, `QStop`, `Restart`, `Reset` or `Step`.

Syntax

```
TriggInt
  [TriggData ::='] <variable (VAR) of triggdata>', '
  [Distance ::='] <expression (IN) of num>
  ['\ Start'] | ['\ Next'] | ['\ Time'],'
  [Interrupt ::='] <variable (VAR) of intnum>
  ['\ Inhib ::='] <persistent (PERS) of bool>
  ['\ Mode ::='] <expression (IN) of triggmode>'];'
```

Continues on next page

1 Instructions

1.314 TriggInt - Defines a position related interrupt

RobotWare Base

Continued

Related information

For information about	See
Use of triggers	TriggL - Linear robot movements with events on page 935 TriggC - Circular robot movement with events on page 891 TriggJ - Axis-wise robot movements with events on page 927
Definition of position fix I/O	TriggIO - Define a fixed position or time I/O event near a stop point on page 921 TriggEquip - Define a fixed position and time I/O event on the path on page 910
Define I/O check at a fixed position	TriggCheckIO - Defines I/O check at a fixed position on page 900
Storage of trigg data	triggdata - Positioning events, trigg on page 1785
Defining different trigg action modes	triggmode - Trigg action mode on page 1791
Interrupts	<i>Technical reference manual - RAPID Overview</i>

1.315 TriggIO - Define a fixed position or time I/O event near a stop point

Usage

TriggIO is used to define conditions and actions for setting a digital, a group of digital, or an analog output signal at a fixed position along the robot's movement path.

TriggIO (not TriggEquip) should always be used if needed for good accuracy of the I/O settings near a stop point.

To obtain a fixed position I/O event, TriggIO compensates for the lag in the control system (lag between robot and servo) but not for any lag in the external equipment. For compensation of both lags use TriggEquip.

The data defined is used for implementation in one or more subsequent TriggL, TriggC, or TriggJ instructions.

This instruction can only be used in the main T_ROB1 task or, if in a *MultiMove* system, in Motion tasks.

Basic examples

The following example illustrates the instruction TriggIO:

See also [More examples on page 924](#).

Example 1

```
VAR triggdata gunon;
...
TriggIO gunon, 0.2\Time\DOp:=gun, 1;
TriggL p1, v500, gunon, fine, gun1;
```

The digital output signal `gun` is set to the value 1 when the TCP is 0,2 seconds before the point `p1`.

The figure shows an example of fixed position I/O event.

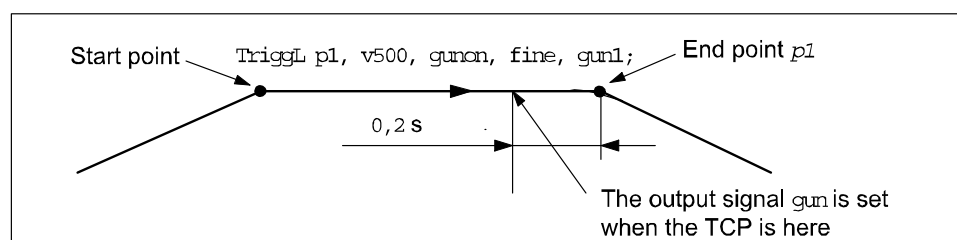

xx0500002247

Arguments

```
TriggIO TriggData Distance [\Start] | [\Time] [\DOp] | [\GOp] |
[\AOp] | [\ProcID] SetValue | SetDvalue [\DODelay] [\Inhib]
[\InhibSetValue] [\Mode]
```

TriggData

Data type: triggdata

Continues on next page

1 Instructions

1.315 TriggIO - Define a fixed position or time I/O event near a stop point

RobotWare Base

Continued

Variable for storing the `triggdata` returned from this instruction. These `triggdata` are then used in the subsequent `TriggL`, `TriggC`, or `TriggJ` instructions.

`Distance`

Data type: `num`

Defines the position on the path where the I/O event shall occur.

Specified as the distance in mm (positive value) from the end point of the movement path (applicable if the argument `\Start` or `\Time` is not set).

See the sections [Program execution on page 924](#), and [Limitations on page 925](#) for further details.

[`\Start`]

Data type: `switch`

Used when the distance for the argument `Distance` starts at the movement start point instead of the end point.

[`\Time`]

Data type: `switch`

Used when the value specified for the argument `Distance` is in fact a time in seconds (positive value) instead of a distance.

Fixed position I/O in time can only be used for short times (< 0.5 s) before the robot reaches the end point of the instruction. See the section *Limitations* for more details.

[`\DOp`]

Digital Output

Data type: `signaldo`

The name of the signal when a digital output signal shall be changed.

[`\GOp`]

Group Output

Data type: `signalgo`

The name of the signal when a group of digital output signals shall be changed.

[`\AOp`]

Analog Output

Data type: `signalao`

The name of the signal when an analog output signal shall be changed.

[`\ProcID`]

Process Identity

Data type: `num`

Not implemented for customer use.

(The identity of the IPM process to receive the event. The selector is specified in the argument `SetValue`.)

`SetValue`

Data type: `num`

Continues on next page

1.315 TriggIO - Define a fixed position or time I/O event near a stop point

RobotWare Base

Continued

The desired value of the signal (within the allowed range for the current signal). If the signal is a digital signal, it must be an integer value. If the signal is a digital group signal, the permitted value is dependent on the number of signals in the group. Max value that can be used in the `SetValue` argument is 8388608, and that is the value a 23 bit digital group signal can have as maximum value (see ranges for `num`).

`SetDvalue`

Data type: `dnum`

The desired value of the signal (within the allowed range for the current signal). If the signal is a digital signal, it must be an integer value. If the signal is a digital group signal, the permitted value is dependent on the number of signals in the group. The maximal amount of signal bits a digital group signal can have is 32. With a `dnum` variable it is possible to cover the value range 0-4294967295, which is the value range a 32 bits digital signal can have.

[`\DODelay`]

Digital Output Delay

Data type: `num`

Time delay in seconds (positive value) for a digital, group, or analog output signal. Only used to delay setting of output signals after the robot has reached the specified position. There will be no delay if the argument is omitted.

The delay is not synchronized with the movement.

[`\Inhib`]

Inhibit

Data type: `bool`

The name of a persistent variable flag for inhibiting the setting of the signal at runtime.

If this optional argument is used and the actual value of the specified flag is `TRUE` at the position-time for setting of the signal then the specified signal (`DOP`, `GOP` or `AOP`) will be set to 0 instead of a specified value.

[`\InhibSetValue`]

InhibitSetValue

Data type: `bool`, `num` or `dnum`

The name of a persistent variable of the data type `bool`, `num` or `dnum` or any alias of those three base data types.

This optional argument can only be used together with optional argument `Inhib`. If this optional argument is used and the value of the persistent variable flag used in optional argument `Inhib` is `TRUE` at the position-time for setting the signal, the value of the persistent variable used in optional argument `InhibSetValue` is read and the value is used for setting of the `DOP`, `GOP` or `AOP` signal.

If using a boolean persistent variable, the value `TRUE` is translated to value 1, and `FALSE` is translated to value 0.

Continues on next page

1 Instructions

1.315 TriggIO - Define a fixed position or time I/O event near a stop point

RobotWare Base

Continued

[\Mode]

Data type: `triggmode`

Is used to specify different action modes when defining triggers.

Program execution

When running the instruction `TriggIO`, the trigger condition is stored in a specified variable in the argument `TriggData`.

Afterwards, when one of the instructions `TriggL`, `TriggC`, or `TriggJ` is executed, the following are applicable with regard to the definitions in `TriggIO`:

The following table describes the distance specified in the argument `Distance`:

Linear movement	The straight line distance
Circular movement	The circle arc length
Non-linear movement	The approximate arc length along the path (to obtain adequate accuracy, the distance should not exceed one half of the arc length).

The figure shows fixed position I/O on a corner path.

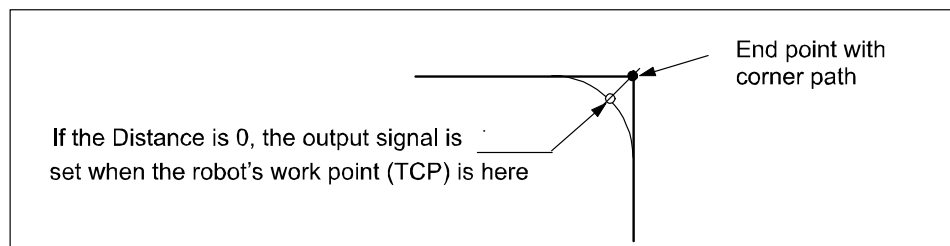

xx0500002248

The fixed position I/O will be generated when the start point (end point) is passed if the specified distance from the end point (start point) is not within the length of movement of the current instruction (`Trigg...`).

Error handling

The following recoverable errors are generated and can be handled in an error handler. The system variable `ERRNO` will be set to:

Name	Cause of error
<code>ERR_AO_LIM</code>	The programmed <code>SetValue</code> argument for the specified analog output signal <code>AOP</code> is out of limit.
<code>ERR_GO_LIM</code>	The programmed <code>SetValue</code> or <code>SetDvalue</code> argument for the specified digital group output signal <code>GOP</code> is out of limit.
<code>ERR_NO_ALIASIO_DEF</code>	The signal variable is a variable declared in RAPID. It has not been connected to an I/O signal defined in the I/O configuration with instruction <code>AliasIO</code> .

More examples

More examples of how to use the instruction `TriggIO` are illustrated below.

Example 1

```
VAR triggdata glueflow;
```

Continues on next page

1.315 TriggIO - Define a fixed position or time I/O event near a stop point

RobotWare Base

Continued

```
TriggIO glueflow, 1 \Start \AOp:=glue, 5.3;
```

```
MoveJ p1, v1000, z50, tool1;
```

```
TriggL p2, v500, glueflow, z50, tool1;
```

The analog output signal `glue` is set to the value 5.3 when the work point (TCP) passes a point located 1 mm after the start point `p1`.

Example 2

```
...
```

```
TriggL p3, v500, glueflow, z50, tool1;
```

The analog output signal `glue` is set once more to the value 5.3 when the work point (TCP) passes a point located 1 mm after the start point `p2`.

Limitations

I/O events with distance (without the argument `\Time`) is intended for flying points (corner path). I/O events with `distance=0`, using stop points, will delay the trigg until the robot has reached the point with accuracy ± 24 ms.

I/O events with time (with the argument `\Time`) are intended for stop points. I/O events with time, using flying points result in worse accuracy than specified below. I/O events with time can only be specified from the end point of the movement.

This time cannot exceed the current braking time of the robot, which is max. approximately 0.5 s (typical values at speed 500 mm/s for IRB 2400 is 150 ms, and for IRB 6400 is 250 ms). If the specified time is greater than the current braking time then the event will be generated anyway but not until braking is started (later than specified). The whole of the movement time for the current movement can be utilized during small and fast movements.

Typical absolute accuracy values for set of digital outputs ± 5 ms. Typical repeat accuracy values for set of digital outputs ± 2 ms.

`TriggIO` cannot be executed in an UNDO handler or RAPID routine connected to any of the following special system events: PowerOn, Stop, QStop, Restart, Reset or Step.

Syntax

```
TriggIO
  [TriggData ':='] <variable (VAR) of triggdata>','
  [Distance ':='] <expression (IN) of num>
  ['\ ' Start] | ['\ ' Time]
  ['\ ' DOp ':='] <variable (VAR) of signaldo>]
  |[ '\ ' GOP ':='] <variable (VAR) of signalgo>]
  |[ '\ ' AOp ':='] <variable (VAR) of signalao>]
  |[ '\ ' ProcID ':='] <expression (IN) of num>'],'
  [SetValue ':='] <expression (IN) of num>
  |[ SetDvalue ':='] <expression (IN) of dnum>
  ['\ ' DODelay ':='] <expression (IN) of num>]
  ['\ ' Inhib ':='] <persistent (PERS) of bool>]
  ['\ ' InhibSetValue ':='] <persistent (PERS) of anytype>]
  ['\ ' Mode ':='] <expression (IN) of triggmode>]';'
```

Continues on next page

1 Instructions

1.315 TriggIO - Define a fixed position or time I/O event near a stop point

RobotWare Base

Continued

Related information

For information about	See
Use of triggers	TriggL - Linear robot movements with events on page 935 TriggC - Circular robot movement with events on page 891 TriggJ - Axis-wise robot movements with events on page 927
Definition of position-time I/O event	TriggEquip - Define a fixed position and time I/O event on the path on page 910
Definition of position related interrupts	TriggInt - Defines a position related interrupt on page 916
Storage of trigg data	triggdata - Positioning events, trigg on page 1785
Defining different trigg action modes	triggmode - Trigg action mode on page 1791
Define I/O check at a fixed position	TriggCheckIO - Defines I/O check at a fixed position on page 900
Set of I/O	SetDO - Changes the value of a digital output signal on page 704 SetGO - Changes the value of a group of digital output signals on page 707 SetAO - Changes the value of an analog output signal on page 694

1.316 TriggJ - Axis-wise robot movements with events

Usage

TriggJ (*TriggJoint*) is used to set output signals and/or run interrupt routines at roughly fixed positions at the same time as the robot is moving quickly from one point to another when that movement does not have to be in a straight line.

One or more (max. 25) events can be defined using the instructions TriggIO, TriggEquip, TriggInt, TriggCheckIO, TriggSpeed, or TriggRampAO and afterwards these definitions are referred to in the instruction TriggJ.

This instruction can only be used in the main task T_ROB1 or, if in a *MultiMove* system, in Motion tasks.

Basic examples

The following example illustrates the instruction TriggJ:

See also [More examples on page 932](#).

Example 1

```
VAR triggdata gunon;
...
TriggIO gunon, 0 \Start \DOp:=gun, 1;
MoveL p1, v500, z50, gun1;
TriggJ p2, v500, gunon, fine, gun1;
```

The digital output signal `gun` is set when the robot's TCP passes the midpoint of the corner path of the point `p1`.

The figure shows an example of fixed position I/O event.

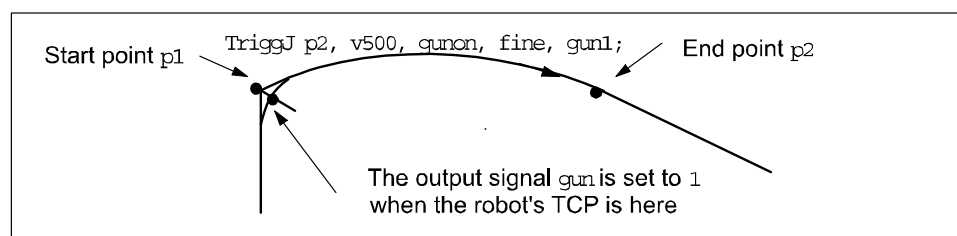

xx0500002272

Arguments

```
TriggJ [\Conc] ToPoint [\ID] Speed [\T] Trigg_1 | TriggArray [ \T2
] [ \T3 ] [\T4] [\T5] [\T6] [\T7] [\T8] Zone [\Inpos] Tool
[\WObj] [\TLoad]
```

[\Conc]

Concurrent

Data type: switch

Subsequent instructions are executed while the robot is moving. The argument is usually not used but can be used to avoid unwanted stops caused by overloaded CPU when using fly-by points. This is useful when the programmed points are very close together at high speeds. The argument is also useful when, for example,

Continues on next page

1 Instructions

1.316 TriggJ - Axis-wise robot movements with events

RobotWare Base

Continued

communicating with external equipment and synchronization between the external equipment and robot movement is not required.

Using the argument `\Conc`, the number of movement instructions in succession is limited to 5. In a program section that includes `StorePath-RestoPath`, movement instructions with the argument `\Conc` are not permitted.

If this argument is omitted and the `ToPoint` is not a stop point then the subsequent instruction is executed some time before the robot has reached the programmed zone.

This argument cannot be used in coordinated synchronized movement in a `MultiMove` system.

`ToPoint`

Data type: `robtarget`

The destination point of the robot and external axes. It is defined as a named position or stored directly in the instruction (marked with an * in the instruction).

[`\ID`]

Synchronization id

Data type: `identno`

The argument [`\ID`] is mandatory in `MultiMove` systems, if the movement is synchronized or coordinated synchronized. This argument is not allowed in any other case. The specified id number must be the same in all the cooperating program tasks. By using the id number the movements are not mixed up at the runtime.

`Speed`

Data type: `speeddata`

The speed data that applies to movements. Speed data defines the velocity of the TCP, the tool reorientation, and external axes.

[`\T`]

Time

Data type: `num`

This argument is used to specify the total time in seconds during which the robot moves. It is substituted for the corresponding speed data. The speed data is computed under the assumption that the speed is constant during the movement. If the robot cannot keep this speed during the whole movement, for example, when the movement starts from a finepoint or ends in a finepoint, the actual movement time will be larger than the programmed time.

`Trigg_1`

Data type: `triggdata`

Variable that refers to trigger conditions and trigger activity defined earlier in the program using the instructions `TriggIO`, `TriggEquip`, `TriggInt`, `TriggCheckIO`, `TriggSpeed`, or `TriggRampAO`.

Continues on next page

TriggArray

Trigg Data Array Parameter

Data type: triggdata

Array variable that refers to trigger conditions and trigger activity defined earlier in the program using the instructions TriggIO, TriggEquip, TriggInt, TriggSpeed, TriggCheckIO, or TriggRampAO.

The limitation is 25 elements in the array and 1 to 25 defined trigger conditions must be defined.

It is not possible to use the optional arguments T2, T3, T4, T5, T6, T7, or T8 at the same time as the TriggArray argument is used.

[\T2]

Trigg 2

Data type: triggdata

Variable that refers to trigger conditions and trigger activity defined earlier in the program using the instructions TriggIO, TriggEquip, TriggInt, TriggCheckIO, TriggSpeed, or TriggRampAO.

[\T3]

Trigg 3

Data type: triggdata

Variable that refers to trigger conditions and trigger activity defined earlier in the program using the instructions TriggIO, TriggEquip, TriggInt, TriggCheckIO, TriggSpeed, or TriggRampAO.

[\T4]

Trigg 4

Data type: triggdata

Variable that refers to trigger conditions and trigger activity defined earlier in the program using the instructions TriggIO, TriggEquip, TriggInt, TriggCheckIO, TriggSpeed, or TriggRampAO.

[\T5]

Trigg 5

Data type: triggdata

Variable that refers to trigger conditions and trigger activity defined earlier in the program using the instructions TriggIO, TriggEquip, TriggInt, TriggCheckIO, TriggSpeed, or TriggRampAO.

[\T6]

Trigg 6

Data type: triggdata

Variable that refers to trigger conditions and trigger activity defined earlier in the program using the instructions TriggIO, TriggEquip, TriggInt, TriggCheckIO, TriggSpeed, or TriggRampAO.

Continues on next page

1 Instructions

1.316 TriggJ - Axis-wise robot movements with events

RobotWare Base

Continued

[\T7]

Trigg 7

Data type: triggdata

Variable that refers to trigger conditions and trigger activity defined earlier in the program using the instructions `TriggIO`, `TriggEquip`, `TriggInt`, `TriggCheckIO`, `TriggSpeed`, or `TriggRampAO`.

[\T8]

Trigg 8

Data type: triggdata

Variable that refers to trigger conditions and trigger activity defined earlier in the program using the instructions `TriggIO`, `TriggEquip`, `TriggInt`, `TriggCheckIO`, `TriggSpeed`, or `TriggRampAO`.

Zone

Data type: zonedata

Zone data for the movement. Zone data describes the size of the generated corner path.

[\Inpos]

In position

Data type: stoppoint data

This argument is used to specify the convergence criteria for the position of the robot's TCP in the stop point. The stop point data substitutes the zone specified in the `Zone` parameter.

Tool

Data type: tooldata

The tool in use when the robot moves. The tool center point is the point that is moved to the specified destination point.

[\WObj]

Work Object

Data type: wobjdata

The work object (object coordinate system) to which the robot position in the instruction is related.

This argument can be omitted and if it is then the position is related to the world coordinate system. If, on the other hand, a stationary TCP or coordinated external axes are used this argument must be specified in order for a circle relative to the work object to be executed.

[\TLoad]

Total load

Data type: loaddata

Continues on next page

The `\TLoad` argument describes the total load used in the movement. The total load is the tool load together with the payload that the tool is carrying. If the `\TLoad` argument is used, then the `loaddata` in the current `tooldata` is not considered.

If the `\TLoad` argument is set to `load0`, then the `\TLoad` argument is not considered and the `loaddata` in the current `tooldata` is used instead.

To be able to use the `\TLoad` argument it is necessary to set the value of the system parameter `ModalPayloadMode` to 0. If `ModalPayloadMode` is set to 0, it is no longer possible to use the instruction `GripLoad`.

The total load can be identified with the service routine `LoadIdentify`. If the system parameter `ModalPayloadMode` is set to 0, the operator has the possibility to copy the `loaddata` from the tool to an existing or new `loaddata` persistent variable when running the service routine.

It is possible to test run the program without any payload by using a digital input signal connected to the system input `SimMode` (Simulated Mode). If the digital input signal is set to 1, the `loaddata` in the optional argument `\TLoad` is not considered, and the `loaddata` in the current `tooldata` is used instead.



Note

The default functionality to handle payload is to use the instruction `GripLoad`. Therefore the default value of the system parameter `ModalPayloadMode` is 1.

Program execution

See the instruction `MoveJ` for information about joint movement.

As the trigger conditions are fulfilled when the robot is positioned closer and closer to the end point, the defined trigger activities are carried out. The trigger conditions are fulfilled either at a certain distance before the end point of the instruction, or at a certain distance after the start point of the instruction, or at a certain point in time (limited to a short time) before the end point of the instruction.

During the stepping execution forward, the I/O activities are carried out but the interrupt routines are not run. During stepping the execution backwards, no trigger activities at all are carried out.

Error handling

The following recoverable errors are generated and can be handled in an error handler. The system variable `ERRNO` will be set to:

Name	Cause of error
<code>ERR_AO_LIM</code>	The programmed <code>ScaleValue</code> argument for the specified analog output signal <code>AOP</code> in some of the connected <code>TriggSpeed</code> instructions result in out of limit for the analog signal together with the programmed <code>Speed</code> in this instruction.
<code>ERR_DIPLAG_LIM</code>	The programmed <code>DipLag</code> argument in some of the connected <code>TriggSpeed</code> instructions is too big in relation to the used Event Preset Time in System Parameters.

Continues on next page

1 Instructions

1.316 TriggJ - Axis-wise robot movements with events

RobotWare Base

Continued

Name	Cause of error
ERR_NORUNUNIT	There is no contact with the I/O device when entering instruction and the used triggdata depends on a running I/O device, i.e. a signal is used in the triggdata.
ERR_CONC_MAX	The number of movement instructions in succession using argument \Conc has been exceeded.

More examples

More examples of how to use the instruction TriggJ are illustrated below.

Example 1

```
VAR intnum intnol;  
VAR triggdata trigg1;  
...  
PROC main()  
  CONNECT intnol WITH trap1;  
  TriggInt trigg1, 0.1 \Time, intnol;  
  ...  
  TriggJ p1, v500, trigg1, fine, gun1;  
  TriggJ p2, v500, trigg1, fine, gun1;  
  ...  
  IDelete intnol;
```

The interrupt routine trap1 is run when the work point is at a position 0.1 s before the stop point p1 or p2 respectively.

Example 2

```
VAR num Distance:=0;  
VAR triggdata trigg_array{25};  
VAR signaldo myaliassignaldo;  
VAR string signalname;  
...  
PROC main()  
  ...  
  FOR i FROM 1 TO 25 DO  
    signalname:="do";  
    signalname:=signalname+ValToStr(i);  
    AliasIO signalname, myaliassignaldo;  
    TriggEquip trigg_array{i}, Distance \Start, 0  
      \Dop:=myaliassignaldo, SetValue:=1;  
    Distance:=Distance+10;  
  ENDFOR  
  TriggJ p1, v500, trigg_array, z30, tool2;  
  MoveJ p2, v500, z30, tool2;  
  ...
```

The digital output signals do1 to do25 is set during the movement to p1. The distance between the signal settings is 10 mm.

Continues on next page

Limitations

If the current start point deviates from the usual so that the total positioning length of the instruction `TriggJ` is shorter than usual (e.g. at the start of `TriggJ` with the robot position at the end point), it may happen that several or all of the trigger conditions are fulfilled immediately and at the same position. In such cases, the sequence in which the trigger activities are carried will be undefined. The program logic in the user program may not be based on a normal sequence of trigger activities for an incomplete movement.

`TriggJ` cannot be executed in an UNDO handler or RAPID routine connected to any of the following special system events: PowerOn, Stop, QStop, Restart, Reset or Step.

Syntax

```
TriggJ
[ '\ Conc ',' ]
[ ToPoint ':=' ] < expression (IN) of robtarget >
[ '\ ID ':=' < expression (IN) of identno > ]', '
[ Speed ':=' ] < expression (IN) of speeddata >
[ '\ T ':=' < expression (IN) of num > ]', '
[ Trigg_1 ':=' ] < variable (VAR) of triggdata > |
[ TriggArray ':=' ] < array variable {*} (VAR) of triggdata >
[ '\ T2 ':=' < variable (VAR) of triggdata > ]
[ '\ T3 ':=' < variable (VAR) of triggdata > ]
[ '\ T4 ':=' < variable (VAR) of triggdata > ]
[ '\ T5 ':=' < variable (VAR) of triggdata > ]
[ '\ T6 ':=' < variable (VAR) of triggdata > ]
[ '\ T7 ':=' < variable (VAR) of triggdata > ]
[ '\ T8 ':=' < variable (VAR) of triggdata > ]', '
[ Zone ':=' ] < expression (IN) of zonedata >
[ '\ Inpos ':=' < expression (IN) of stoppointdata > ]', '
[ Tool ':=' ] < persistent (PERS) of tooldata >
[ '\ WObj ':=' < persistent (PERS) of wobjdata > ]
[ '\ TLoad ':=' < persistent (PERS) of loaddata > ] ';'

```

Related information

For information about	See
Linear movement with triggers	TriggL - Linear robot movements with events on page 935
Circular movement with triggers	TriggC - Circular robot movement with events on page 891

Continues on next page

1 Instructions

1.316 TriggJ - Axis-wise robot movements with events

RobotWare Base

Continued

For information about	See
Definition of triggers	TriggIO - Define a fixed position or time I/O event near a stop point on page 921 TriggEquip - Define a fixed position and time I/O event on the path on page 910 TriggRampAO - Define a fixed position ramp AO event on the path on page 958 TriggInt - Defines a position related interrupt on page 916 TriggCheckIO - Defines I/O check at a fixed position on page 900
Handling <code>triggdata</code>	triggdata - Positioning events, <code>trigg</code> on page 1785 TriggDataReset - Reset the content in a <code>triggdata</code> variable on page 908 TriggDataCopy - Copy the content in a <code>triggdata</code> variable on page 906 TriggDataValid - Check if the content in a <code>triggdata</code> variable is valid on page 1528
Moves the robot by joint movement	MoveJ - Moves the robot by joint movement on page 434
Joint movement	<i>Technical reference manual - RAPID Overview</i>
Definition of load	loaddata - Load data on page 1682
Definition of velocity	speeddata - Speed data on page 1751
Definition of stop point data	stoppointdata - Stop point data on page 1755
Definition of tools	tooldata - Tool data on page 1776
Definition of work object	wobjdata - Work object data on page 1803
Definition of zone data	zonedata - Zone data on page 1811
Motion in general	<i>Technical reference manual - RAPID Overview</i>
Example of how to use <code>TLoad</code> , <code>Total Load</code> .	MoveL - Moves the robot linearly on page 458
Defining the payload for a robot	GripLoad - Defines the payload for a robot on page 243
<code>LoadIdentify</code> , load identification service routine	<i>Operating manual - IRC5 with FlexPendant</i>
System input signal <code>SimMode</code> for running the robot in simulated mode without payload	<i>Technical reference manual - System parameters</i>
System parameter <code>ModalPayload-Mode</code> for activating and deactivating payload	<i>Technical reference manual - System parameters</i>

1.317 TriggL - Linear robot movements with events

Usage

TriggL (*Trigg Linear*) is used to set output signals and/or run interrupt routines at fixed positions at the same time that the robot is making a linear movement. One or more (max. 25) events can be defined using the instructions TriggIO, TriggEquip, TriggInt, TriggSpeed, TriggCheckIO, or TriggRampAO. Afterwards these definitions are referred to in the instruction TriggL. This instruction can only be used in the main task T_ROB1 or, if in a *MultiMove* system, in Motion tasks.

Basic examples

The following example illustrates the instruction TriggL:

See also [More examples on page 940](#).

Example 1

```
VAR triggdata gunon;

TriggIO gunon, 0 \Start \DOp:=gun, 1;
MoveJ p1, v500, z50, gun1;
TriggL p2, v500, gunon, fine, gun1;
```

The digital output signal `gun` is set when the robot's TCP passes the midpoint of the corner path of the point `p1`.

The figure shows an example of fixed position I/O event.

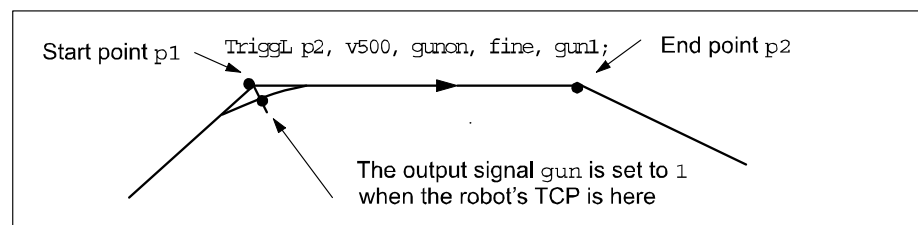

xx0500002291

Arguments

```
TriggL [\Conc] ToPoint [\ID] Speed [\T] Trigg_1 | TriggArray [\T2]
[\T3] [\T4] [\T5] [\T6] [\T7] [\T8] Zone [\Inpos] Tool [\WObj]
[\Corr] [\TLoad]
```

[\Conc]

Concurrent

Data type: switch

Subsequent instructions are executed while the robot is moving. The argument is usually not used but can be used to avoid unwanted stops caused by overloaded CPU when using fly-by points. This is useful when the programmed points are very close together at high speeds. The argument is also useful when, for example,

Continues on next page

1 Instructions

1.317 TriggL - Linear robot movements with events

RobotWare Base

Continued

communicating with external equipment and synchronization between the external equipment and robot movement is not required.

Using the argument `\Conc`, the number of movement instructions in succession is limited to 5. In a program section that includes `StorePath-RestoPath`, movement instructions with the argument `\Conc` are not permitted.

If this argument is omitted and the `ToPoint` is not a stop point then the subsequent instruction is executed some time before the robot has reached the programmed zone.

This argument cannot be used in coordinated synchronized movement in a `MultiMove` system.

`ToPoint`

Data type: `robtarget`

The destination point of the robot and external axes. It is defined as a named position or stored directly in the instruction (marked with an * in the instruction).

[`\ID`]

Synchronization id

Data type: `identno`

The argument [`\ID`] is mandatory in `MultiMove` systems, if the movement is synchronized or coordinated synchronized. This argument is not allowed in any other case. The specified id number must be the same in all the cooperating program tasks. By using the id number the movements are not mixed up at the runtime.

`Speed`

Data type: `speeddata`

The speed data that applies to movements. Speed data defines the velocity of the TCP, the tool reorientation, and external axes.

[`\T`]

Time

Data type: `num`

This argument is used to specify the total time in seconds during which the robot moves. It is substituted for the corresponding speed data. The speed data is computed under the assumption that the speed is constant during the movement. If the robot cannot keep this speed during the whole movement, for example, when the movement starts from a finepoint or ends in a finepoint, the actual movement time will be larger than the programmed time.

`Trigg_1`

Data type: `triggdata`

Variable that refers to trigger conditions and trigger activity defined earlier in the program using the instructions `TriggIO`, `TriggEquip`, `TriggInt`, `TriggCheckIO`, `TriggSpeed`, or `TriggRampAO`.

Continues on next page

TriggArray

Trigg Data Array Parameter**Data type:** triggdata

Array variable that refers to trigger conditions and trigger activity defined earlier in the program using the instructions TriggIO, TriggEquip, TriggInt, TriggSpeed, TriggCheckIO, or TriggRampAO.

The limitation is 25 elements in the array and 1 to 25 defined trigger conditions must be defined.

It is not possible to use the optional arguments T2, T3, T4, T5, T6, T7, or T8 at the same time as the TriggArray argument is used.

[\T2]

Trigg 2**Data type:** triggdata

Variable that refers to trigger conditions and trigger activity defined earlier in the program using the instructions TriggIO, TriggEquip, TriggInt, TriggCheckIO, TriggSpeed, or TriggRampAO.

[\T3]

Trigg 3**Data type:** triggdata

Variable that refers to trigger conditions and trigger activity defined earlier in the program using the instructions TriggIO, TriggEquip, TriggInt, TriggCheckIO, TriggSpeed, or TriggRampAO.

[\T4]

Trigg 4**Data type:** triggdata

Variable that refers to trigger conditions and trigger activity defined earlier in the program using the instructions TriggIO, TriggEquip, TriggInt, TriggCheckIO, TriggSpeed, or TriggRampAO.

[\T5]

Trigg 5**Data type:** triggdata

Variable that refers to trigger conditions and trigger activity defined earlier in the program using the instructions TriggIO, TriggEquip, TriggInt, TriggCheckIO, TriggSpeed, or TriggRampAO.

[\T6]

Trigg 6**Data type:** triggdata

Variable that refers to trigger conditions and trigger activity defined earlier in the program using the instructions TriggIO, TriggEquip, TriggInt, TriggCheckIO, TriggSpeed, or TriggRampAO.

Continues on next page

1 Instructions

1.317 TriggL - Linear robot movements with events

RobotWare Base

Continued

[\T7]

Trigg 7

Data type: triggdata

Variable that refers to trigger conditions and trigger activity defined earlier in the program using the instructions `TriggIO`, `TriggEquip`, `TriggInt`, `TriggCheckIO`, `TriggSpeed`, or `TriggRampAO`.

[\T8]

Trigg 8

Data type: triggdata

Variable that refers to trigger conditions and trigger activity defined earlier in the program using the instructions `TriggIO`, `TriggEquip`, `TriggInt`, `TriggCheckIO`, `TriggSpeed`, or `TriggRampAO`.

Zone

Data type: zonedata

Zone data for the movement. Zone data describes the size of the generated corner path.

[\Inpos]

In position

Data type: stoppoint data

This argument is used to specify the convergence criteria for the position of the robot's TCP in the stop point. The stop point data substitutes the zone specified in the `Zone` parameter.

Tool

Data type: tooldata

The tool in use when the robot moves. The tool center point is the point that is moved to the specified destination point.

[\WObj]

Work Object

Data type: wobjdata

The work object (object coordinate system) to which the robot position in the instruction is related.

This argument can be omitted and if it is then the position is related to the world coordinate system. If, on the other hand, a stationary TCP or coordinated external axes are used this argument must be specified in order for a circle relative to the work object to be executed.

[\Corr]

Correction

Data type: switch

Correction data written to a corrections entry by the instruction `CorrWrite` will be added to the path and destination position if this argument is present.

Continues on next page

The RobotWare option *Path Offset* is required when using this argument.

[\TLoad]

Total load

Data type: loaddata

The \TLoad argument describes the total load used in the movement. The total load is the tool load together with the payload that the tool is carrying. If the \TLoad argument is used, then the loaddata in the current tooldata is not considered.

If the \TLoad argument is set to load0, then the \TLoad argument is not considered and the loaddata in the current tooldata is used instead.

To be able to use the \TLoad argument it is necessary to set the value of the system parameter ModalPayLoadMode to 0. If ModalPayLoadMode is set to 0, it is no longer possible to use the instruction GripLoad.

The total load can be identified with the service routine LoadIdentify. If the system parameter ModalPayLoadMode is set to 0, the operator has the possibility to copy the loaddata from the tool to an existing or new loaddata persistent variable when running the service routine.

It is possible to test run the program without any payload by using a digital input signal connected to the system input SimMode (Simulated Mode). If the digital input signal is set to 1, the loaddata in the optional argument \TLoad is not considered, and the loaddata in the current tooldata is used instead.



Note

The default functionality to handle payload is to use the instruction GripLoad. Therefore the default value of the system parameter ModalPayLoadMode is 1.

Program execution

See the instruction MoveL for information about linear movement.

As the trigger conditions are fulfilled when the robot is positioned closer and closer to the end point, the defined trigger activities are carried out. The trigger conditions are fulfilled either at a certain distance before the end point of the instruction, or at a certain distance after the start point of the instruction, or at a certain point in time (limited to a short time) before the end point of the instruction.

During stepping the execution forward, the I/O activities are carried out but the interrupt routines are not run. During stepping the execution backwards, no trigger activities at all are carried out.

Continues on next page

1 Instructions

1.317 TriggL - Linear robot movements with events

RobotWare Base

Continued

Error handling

The following recoverable errors are generated and can be handled in an error handler. The system variable `ERRNO` will be set to:

Name	Cause of error
<code>ERR_AO_LIM</code>	The programmed <code>ScaleValue</code> argument for the specified analog output signal <code>AOp</code> in some of the connected <code>TriggSpeed</code> instructions result in out of limit for the analog signal together with the programmed <code>Speed</code> in this instruction.
<code>ERR_DIPLAG_LIM</code>	The programmed <code>DipLag</code> argument in some of the connected <code>TriggSpeed</code> instructions is too big in relation to the used <code>Event Preset Time</code> in <code>System Parameters</code> .
<code>ERR_NORUNUNIT</code>	There is no contact with the I/O device when entering instruction and the used <code>triggdata</code> depends on a running I/O device, i.e. a signal is used in the <code>triggdata</code> .
<code>ERR_CONC_MAX</code>	The number of movement instructions in succession using argument <code>\Conc</code> has been exceeded.

More examples

More examples of how to use the instruction `TriggL` are illustrated below.

Example 1

```
VAR intnum intnol;  
VAR triggdata trigg1;  
...  
PROC main()  
  CONNECT intnol WITH trap1;  
  TriggInt trigg1, 0.1 \Time, intnol;  
  ...  
  TriggL p1, v500, trigg1, fine, gun1;  
  TriggL p2, v500, trigg1, fine, gun1;  
  ...  
  IDelete intnol;
```

The interrupt routine `trap1` is run when the work point is at a position `0.1 s` before the point `p1` or `p2` respectively.

Example 2

```
VAR num Distance:=0;  
VAR triggdata trigg_array{25};  
VAR signaldo myaliassignaldo;  
VAR string signalname;  
...  
PROC main()  
  ...  
  FOR i FROM 1 TO 25 DO  
    signalname:="do";  
    signalname:=signalname+ValToStr(i);  
    AliasIO signalname, myaliassignaldo;  
    TriggEquip trigg_array{i}, Distance \Start, 0  
      \Dop:=myaliassignaldo, SetValue:=1;  
    Distance:=Distance+10;
```

Continues on next page

```

ENDFOR
TriggL p1, v500, trigg_array, z30, tool2;
MoveL p2, v500, z30, tool2;
...

```

The digital output signals do1 to do25 is set during the movement to p1. The distance between the signal settings is 10 mm.

Limitations

If the current start point deviates from the usual so that the total positioning length of the instruction TriggL is shorter than usual (e.g. at the start of TriggL with the robot position at the end point) it may happen that several or all of the trigger conditions are fulfilled immediately and at the same position. In such cases, the sequence in which the trigger activities are carried out will be undefined. The program logic in the user program may not be based on a normal sequence of trigger activities for an incomplete movement.

TriggL cannot be executed in an UNDO handler or RAPID routine connected to any of the following special system events: PowerOn, Stop, QStop, Restart, Reset or Step.

Syntax

```

TriggL
  ['\' Conc ',']
  [ToPoint' :='] <expression (IN) of robtarg>
  ['\' ID :=' <expression (IN) of identno>'],'
  [Speed :='] <expression (IN) of speeddata>
  ['\' T :=' <expression (IN) of num>'],'
  [Trigg_1 :='] <variable (VAR) of triggdata>|
  [TriggArray :='] <array variable {*} (VAR) of triggdata>
  ['\' T2 :=' <variable (VAR) of triggdata>]
  ['\' T3 :=' <variable (VAR) of triggdata>]
  ['\' T4 :=' <variable (VAR) of triggdata>]
  ['\' T5 :=' <variable (VAR) of triggdata>]
  ['\' T6 :=' <variable (VAR) of triggdata>]
  ['\' T7 :=' <variable (VAR) of triggdata>]
  ['\' T8 :=' <variable (VAR) of triggdata>'],'
  [Zone :='] <expression (IN) of zonedata>
  ['\' Inpos :=' <expression (IN) of stoppointdata>'],'
  [Tool :='] <persistent (PERS) of tooldata>
  ['\' WObj :=' <persistent (PERS) of wobjdata>]
  ['\' Corr]
  ['\' TLoad :=' <persistent (PERS) of loaddata>'];'

```

Related information

For information about	See
Circular movement with triggers	TriggC - Circular robot movement with events on page 891
Joint movement with triggers	TriggJ - Axis-wise robot movements with events on page 927

Continues on next page

1 Instructions

1.317 TriggL - Linear robot movements with events

RobotWare Base

Continued

For information about	See
Definition of triggers	TriggIO - Define a fixed position or time I/O event near a stop point on page 921 TriggEquip - Define a fixed position and time I/O event on the path on page 910 TriggInt - Defines a position related interrupt on page 916 TriggCheckIO - Defines I/O check at a fixed position on page 900 TriggRampAO - Define a fixed position ramp AO event on the path on page 958 TriggSpeed - Defines TCP speed proportional analog output with fixed position-time scale event on page 965
Handling <code>triggdata</code>	triggdata - Positioning events, <code>trigg</code> on page 1785 TriggDataReset - Reset the content in a <code>triggdata</code> variable on page 908 TriggDataCopy - Copy the content in a <code>triggdata</code> variable on page 906 TriggDataValid - Check if the content in a <code>triggdata</code> variable is valid on page 1528
Writes to a corrections entry	CorrWrite - Writes to a correction generator on page 180
Linear movement	<i>Technical reference manual - RAPID Overview</i>
Definition of load	loaddata - Load data on page 1682
Definition of velocity	speeddata - Speed data on page 1751
Definition of stop point data	stoppointdata - Stop point data on page 1755
Definition of tools	tooldata - Tool data on page 1776
Definition of work objects	wobjdata - Work object data on page 1803
Definition of zone data	zonedata - Zone data on page 1811
Motion in general	<i>Technical reference manual - RAPID Overview</i>
Example of how to use <code>TLoad</code> , Total Load.	MoveL - Moves the robot linearly on page 458
Defining the payload for a robot	GripLoad - Defines the payload for a robot on page 243
<code>LoadIdentify</code> , load identification service routine	<i>Operating manual - IRC5 with FlexPendant</i>
System input signal <code>SimMode</code> for running the robot in simulated mode without payload	<i>Technical reference manual - System parameters</i>
System parameter <code>ModalPayloadMode</code> for activating and deactivating payload	<i>Technical reference manual - System parameters</i>
<i>Path Offset</i>	<i>Application manual - Controller software IRC5</i>

1.318 TriggJIos - Joint robot movements with I/O events

Usage

TriggJIos (*Trigg Joint I/O*) is used to set output signals at fixed positions at the same time that the robot is making a joint movement.

The TriggJIos instruction is optimized to give good accuracy when using movements with zones (compare with TriggEquip/TriggL).

This instruction can only be used in the main task T_ROB1 or, if in a *MultiMove* system, in Motion tasks.

Basic examples

The following example illustrates the instruction TriggJIos:

See also [More examples on page 954](#).

Example 1

```
VAR triggios gunon{1};

gunon{1}.used:=TRUE;
gunon{1}.distance:=3;
gunon{1}.start:=TRUE;
gunon{1}.signalname:="gun";
gunon{1}.equiplag:=0;
gunon{1}.setvalue:=1;

MoveJ p1, v500, z50, gun1;
TriggJIos p2, v500, \TriggData1:=gunon, z50, gun1;
MoveL p3, v500, z50, gun1;
```

The signal `gun` is set when the TCP is 3 mm after point `p1`.

The RAPID code and figure shows an example of a fixed position I/O event.

```
TriggJIos p2, v500, \TriggData1:=gunon, z50, gun1;
```

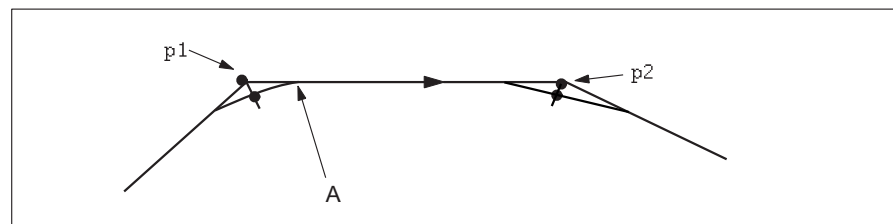

xx1500000304

A The output signal `gun` is set to 1 when the robot's TCP is here.

Arguments

```
TriggJIos [\Conc] ToPoint [\ID] Speed [\T] [\TriggData1]
[\TriggData2] [\TriggData3] Zone [\Inpos] Tool [\WObj]
[\TLoad]
```

[\Conc]

Concurrent

Data type: switch

Continues on next page

1 Instructions

1.318 TriggJIOs - Joint robot movements with I/O events

RobotWare Base

Continued

Subsequent instructions are executed while the robot is moving. The argument is usually not used but can be used to avoid unwanted stops caused by overloaded CPU when using fly-by points. This is useful when the programmed points are very close together at high speeds. The argument is also useful when, for example, communicating with external equipment and synchronization between the external equipment and robot movement is not required.

Using the argument `\Conc`, the number of movement instructions in succession is limited to 5. In a program section that includes `StorePath-RestoPath`, movement instructions with the argument `\Conc` are not permitted.

If this argument is omitted and the `ToPoint` is not a stop point then the subsequent instruction is executed some time before the robot has reached the programmed zone.

This argument cannot be used in coordinated synchronized movement in a MultiMove system.

`ToPoint`

Data type: `robtarget`

The destination point of the robot and external axes. It is defined as a named position or stored directly in the instruction (marked with an * in the instruction).

[`\ID`]

Synchronization id

Data type: `identno`

The argument [`\ID`] is mandatory in MultiMove systems, if the movement is synchronized or coordinated synchronized. This argument is not allowed in any other case. The specified id number must be the same in all the cooperating program tasks. By using the id number the movements are not mixed up at the runtime.

`Speed`

Data type: `speeddata`

The speed data that applies to movements. Speed data defines the velocity of the TCP, the tool reorientation, and external axes.

[`\T`]

Time

Data type: `num`

This argument is used to specify the total time in seconds during which the robot moves. It is substituted for the corresponding speed data. The speed data is computed under the assumption that the speed is constant during the movement. If the robot cannot keep this speed during the whole movement, for example, when the movement starts from a finepoint or ends in a finepoint, the actual movement time will be larger than the programmed time.

[`\TriggData1`]

Data type: array of `triggios`

Continues on next page

Variable (array) that refers to trigger conditions and trigger activity. When using this argument, it is possible to set analog output signals, digital output signals and digital group output signals. If using a digital group output signal there is a limitation on 23 signals in the group.

[\TriggData2]

Data type: array of triggstrgo

Variable (array) that refers to trigger conditions and trigger activity. When using this argument, it is possible to set digital group output signals that consists of 32 signals in the group and can have a maximum set value of 4294967295. Only digital group output signals can be used.

[\TriggData3]

Data type: array of triggiosdnum

Variable (array) that refers to trigger conditions and trigger activity. When using this argument, it is possible to set analog output signals, digital output signals and digital group output signals that consists of 32 signals in the group and can have a maximum set value of 4294967295.

Zone

Data type: zonedata

Zone data for the movement. Zone data describes the size of the generated corner path.

[\Inpos]

In position

Data type: stoppoint data

This argument is used to specify the convergence criteria for the position of the robot's TCP in the stop point. The stop point data substitutes the zone specified in the `Zone` parameter.

Tool

Data type: tooldata

The tool in use when the robot moves. The tool center point is the point that is moved to the specified destination point.

[\WObj]

Work Object

Data type: wobjdata

The work object (object coordinate system) to which the robot position in the instruction is related.

This argument can be omitted and if it is then the position is related to the world coordinate system. If, on the other hand, a stationary TCP or coordinated external axes are used this argument must be specified in order for a circle relative to the work object to be executed.

[\TLoad]

Total load

Continues on next page

1 Instructions

1.318 TriggJIos - Joint robot movements with I/O events

RobotWare Base

Continued

Data type: loaddata

The `\TLoad` argument describes the total load used in the movement. The total load is the tool load together with the payload that the tool is carrying. If the `\TLoad` argument is used, then the `loaddata` in the current `tooldata` is not considered.

If the `\TLoad` argument is set to `load0`, then the `\TLoad` argument is not considered and the `loaddata` in the current `tooldata` is used instead.

To be able to use the `\TLoad` argument it is necessary to set the value of the system parameter `ModalPayloadMode` to 0. If `ModalPayloadMode` is set to 0, it is no longer possible to use the instruction `GripLoad`.

The total load can be identified with the service routine `LoadIdentify`. If the system parameter `ModalPayloadMode` is set to 0, the operator has the possibility to copy the `loaddata` from the tool to an existing or new `loaddata` persistent variable when running the service routine.

It is possible to test run the program without any payload by using a digital input signal connected to the system input `SimMode` (Simulated Mode). If the digital input signal is set to 1, the `loaddata` in the optional argument `\TLoad` is not considered, and the `loaddata` in the current `tooldata` is used instead.



Note

The default functionality to handle payload is to use the instruction `GripLoad`. Therefore the default value of the system parameter `ModalPayloadMode` is 1.

Program execution

See the instruction `MoveJ` for information about joint movement, [MoveJ - Moves the robot by joint movement on page 434](#).

With the instruction `TriggJIos` it is possible to setup 1-50 different trigger activities on I/O signals along a path from A to B. The signals that can be used are digital output signals, digital group output signals and analog output signals. The trigger conditions are fulfilled either at a certain distance before the end point of the instruction, or at a certain distance after the start point of the instruction.

The instruction requires use of either `TriggData1`, `TriggData2`, or `TriggData3` argument or all three of them. Use of any of the trigs is optional though. To inhibit use of a trig the component used can be set to `FALSE` in the array element of the data types `triggios/triggstrgo/triggiosdnum`. If no array element is in use, then the `TriggJIos` instruction will behave as a `MoveJ`, and no I/O activities will be carried out.

If stepping the program forward, the I/O activities are carried out. During stepping the execution backwards, no I/O activities at all are carried out.

If setting component `EquipLag` in `TriggData1`, `TriggData2` or `TriggData3` argument to a negative time (delay), the I/O signal can be set after the destination point (`ToPoint`).

If using the argument `TriggData2` or `TriggData3` it is possible to use values up to 4294967295, which is the maximum value a group of digital signals can have (32 signals in a group signal is max for the system).

Continues on next page

Error handling

The following recoverable errors are generated and can be handled in an error handler. The system variable `ERRNO` will be set to:

Name	Cause of error
ERR_NORUNUNIT	There is no contact with the I/O device.
ERR_GO_LIM	The programmed <code>setvalue</code> argument for the specified digital group output signal <code>signalname</code> is outside limits. (Declared in <code>TriggData1</code> , <code>TriggData2</code> or <code>TriggData3</code>).
ERR_AO_LIM	The programmed <code>setvalue</code> argument for the specified analog output signal <code>signalname</code> is outside limits. (Declared in <code>TriggData1</code> or <code>TriggData3</code>).

More examples

More examples of how to use the instruction `TriggJIos` are illustrated below.

Example 1

```
VAR triggios mytriggios{3}:= [[TRUE, 3, TRUE, 0, "go1", 55, 0],
    [TRUE, 15, TRUE, 0, "ao1", 10, 0], [TRUE, 3, FALSE, 0, "do1",
    1, 0]];
...
MoveL p1, v500, z50, gun1;
TriggJIos p2, v500, \TriggData1:=mytriggios, z50, gun1;
MoveL p3, v500, z50, gun1;
```

The digital group output signal `go1` will be set to value 55 3 mm from `p1`. Analog output signal will be set to value 10 15 mm from `p1`. Digital output signal `do1` will be set 3 mm from `ToPoint p2`.

Example 2

```
VAR triggios mytriggios{3}:= [[TRUE, 3, TRUE, 0, "go1", 55, 0],
    [TRUE, 15, TRUE, 0, "ao1", 10, 0], [TRUE, 3, FALSE, 0, "do1",
    1, 0]];
VAR triggstrgo mytriggstrgo{3}:= [[TRUE, 3, TRUE, 0, "go2", "1",
    0], [TRUE, 15, TRUE, 0, "go2", "800000", 0], [TRUE, 4, FALSE,
    0, "go2", "4294967295", 0]];
VAR triggiosdnum mytriggiosdnum{3}:= [[TRUE, 10, TRUE, 0, "go3",
    4294967295, 0], [TRUE, 10, TRUE, 0, "ao2", 5, 0], [TRUE, 10,
    TRUE, 0, "do2", 1, 0]];
...
MoveL p1, v500, z50, gun1;
TriggJIos p2, v500, \TriggData1:=mytriggios \TriggData2:=
    mytriggstrgo \TriggData3:=mytriggiosdnum, z50, gun1;
MoveL p3, v500, z50, gun1;
```

The digital group output signal `go1` will be set to value 55 3 mm from `p1`. Analog output signal `ao1` will be set to value 10 15 mm from `p1`. Digital output signal `do1` will be set 3 mm from `ToPoint p2`. Those position events is setup by variable `mytriggios`. The variable `mytriggstrgo` sets up position events to occur 3 and 15 mm from `p1`. First the signal `go2` is set to 1, then it is set to 800000. The signal will be set to value 4294967295 4 mm from the `ToPoint p2`. This is the maximum

Continues on next page

1 Instructions

1.318 TriggJIos - Joint robot movements with I/O events

RobotWare Base

Continued

value for a 32 bits digital output signal. The variable `mytriggiosdnum` sets up three position events to occur 10 mm from `p1`. First the signal `go3` is set to 4294967295, then `ao2` is set to 5 and last `do2` is set to 1.

Limitations

If the current start point deviates from the usual so that the total positioning length of the instruction `TriggJIos` is shorter than usual (e.g. at the start of `TriggJIos` with the robot position at the end point) it may happen that several or all of the trigger conditions are fulfilled immediately and at the same position. In such cases, the sequence in which the trigger activities are carried out will be undefined. The program logic in the user program may not be based on a normal sequence of trigger activities for an incomplete movement.

The limitation of the number of triggs in the instruction `TriggJIos` is 50 for each programmed instruction. If triggs happen at a closer distance, the system might not handle it. That depends on how the movement is done, TCP speed used and how close the triggs are programmed. Those limitations exists, but it is hard to predict when those problems will occur.

`TriggJIos` cannot be executed in an UNDO handler or RAPID routine connected to any of the following special system events: PowerOn, Stop, QStop, Restart, Reset or Step.

Limitations regarding accuracy

I/O events with distance is intended for flying points (corner path). Using stop points will result in worse accuracy than specified below.

Regarding the accuracy for I/O events with distance and using flying points, the following is applicable when setting a digital output at a specified distance from the start point or end point in the instruction `TriggLIos` or `TriggCIos`:

- The accuracy specified below is valid when using a positive `equiplag`¹ that is less than 40 ms, which is equivalent to the lag in the robot servo, without changing the system parameter *Event Preset Time*. The lag can vary between different robot types.
- The accuracy specified below is valid when using a positive `equiplag` that is less than the configured *Event Preset Time* in the system parameters.
- The accuracy specified below is not valid when using a positive `equiplag` that is larger than the configured *Event Preset Time* in the system parameters. In this case, an approximate method is used in which the dynamic limitations of the robot are not taken into consideration. Then `SingArea \Wrist` must be used to achieve an acceptable accuracy.
- The accuracy specified below is valid when using a negative `equiplag`.

¹ `equiplag` is a dataobject of data type `triggios`

The typical absolute accuracy values for setting digital outputs is: ± 5 ms.

The typical repeat accuracy values for setting digital outputs is: ± 2 ms.

Syntax

```
TriggJIos
  ['\ Conc ',']
```

Continues on next page

1.318 TriggI/Os - Joint robot movements with I/O events

RobotWare Base

Continued

```
[ToPoint ':='] <expression (IN) of robtargt>
['\ ID ':='] <expression (IN) of identno>'],'
[Speed ':='] <expression (IN) of speeddata>
['\ T ':='] <expression (IN) of num>'],'
['\ TriggData1 ':='] <array {*} (VAR) of triggios>
['\ TriggData2 ':='] <array {*} (VAR) of triggstrgo>
['\ TriggData3 ':='] <array {*} (VAR) of triggiosdnum>'],'
[Zone ':='] <expression (IN) of zonedata>
['\ Inpos ':='] <expression (IN) of stoppointdata>'],'
[Tool ':='] <persistent (PERS) of tooldata>
['\ WObj ':='] <persistent (PERS) of wobjdata>]
['\ TLoad ':='] <persistent (PERS) of loaddata>]';'
```

Related information

For information about	See
Linear robot movements with I/O events	TriggI/Os - Linear robot movements with I/O events on page 950
Storage of trigg conditions and trigger activity	triggios - Positioning events, trigg on page 1786
Storage of trigg conditions and trigger activity for digital signal group consisting of 32 signals	triggstrgo - Positioning events, trigg on page 1794
Storage of trigg conditions and trigger activity	triggiosdnum - Positioning events, trigg on page 1789
Allocation of event objects	<i>Technical reference manual - System parameters</i>
Linear movement	<i>Technical reference manual - RAPID Overview</i>
Motion in general	<i>Technical reference manual - RAPID Overview</i>
Definition of load	loaddata - Load data on page 1682
Example of how to use TLoad, Total Load.	MoveL - Moves the robot linearly on page 458
Defining the payload for a robot	GripLoad - Defines the payload for a robot on page 243
LoadIdentify, load identification service routine	<i>Operating manual - IRC5 with FlexPendant</i>
System input signal <i>SimMode</i> for running the robot in simulated mode without payload	<i>Technical reference manual - System parameters</i>
System parameter <i>ModalPayLoadMode</i> for activating and deactivating payload	<i>Technical reference manual - System parameters</i>
<i>Path Offset</i>	<i>Application manual - Controller software IRC5</i>

1 Instructions

1.319 TriggLIOS - Linear robot movements with I/O events

RobotWare Base

1.319 TriggLIOS - Linear robot movements with I/O events

Usage

TriggLIOS (Trigg Linear I/O) is used to set output signals at fixed positions at the same time that the robot is making a linear movement.

The TriggLIOS instruction is optimized to give good accuracy when using movements with zones (compare with TriggEquip/TriggL).

This instruction can only be used in the main task T_ROB1 or, if in a *MultiMove* system, in Motion tasks.

Basic examples

The following example illustrates the instruction TriggLIOS:

See also [More examples on page 954](#).

Example 1

```
VAR triggios gunon{1};

gunon{1}.used:=TRUE;
gunon{1}.distance:=3;
gunon{1}.start:=TRUE;
gunon{1}.signalname="gun";
gunon{1}.equiplag:=0;
gunon{1}.setvalue:=1;

MoveJ p1, v500, z50, gun1;
TriggLIOS p2, v500, \TriggData1:=gunon, z50, gun1;
MoveL p3, v500, z50, gun1;
```

The signal `gun` is set when the TCP is 3 mm after point `p1`.

The figure shows an example of a fixed position I/O event.

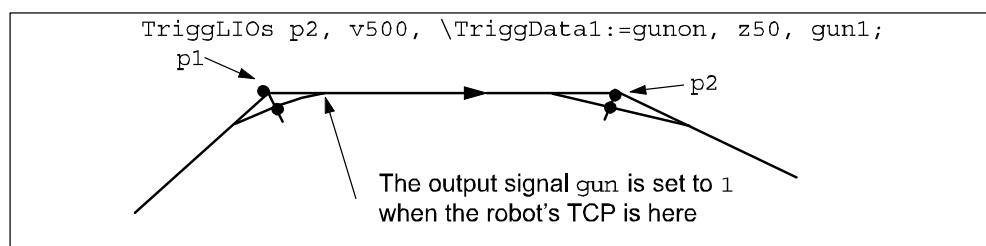

en0800000157

Arguments

```
TriggLIOS [\Conc] ToPoint [\ID] Speed [\T] [\TriggData1]
[\TriggData2] [\TriggData3] Zone [\Inpos] Tool [\WObj] [\Corr]
[\TLoad]
```

[\Conc]

Concurrent

Data type: switch

Continues on next page

Subsequent instructions are executed while the robot is moving. The argument is usually not used but can be used to avoid unwanted stops caused by overloaded CPU when using fly-by points. This is useful when the programmed points are very close together at high speeds. The argument is also useful when, for example, communicating with external equipment and synchronization between the external equipment and robot movement is not required.

Using the argument `\Conc`, the number of movement instructions in succession is limited to 5. In a program section that includes `StorePath-RestoPath`, movement instructions with the argument `\Conc` are not permitted.

If this argument is omitted and the `ToPoint` is not a stop point then the subsequent instruction is executed some time before the robot has reached the programmed zone.

This argument cannot be used in coordinated synchronized movement in a `MultiMove` system.

`ToPoint`

Data type: `robtarget`

The destination point of the robot and external axes. It is defined as a named position or stored directly in the instruction (marked with an * in the instruction).

[`\ID`]

Synchronization id

Data type: `identno`

The argument [`\ID`] is mandatory in `MultiMove` systems, if the movement is synchronized or coordinated synchronized. This argument is not allowed in any other case. The specified id number must be the same in all the cooperating program tasks. By using the id number the movements are not mixed up at the runtime.

`Speed`

Data type: `speeddata`

The speed data that applies to movements. Speed data defines the velocity of the TCP, the tool reorientation, and external axes.

[`\T`]

Time

Data type: `num`

This argument is used to specify the total time in seconds during which the robot moves. It is substituted for the corresponding speed data. The speed data is computed under the assumption that the speed is constant during the movement. If the robot cannot keep this speed during the whole movement, for example, when the movement starts from a finepoint or ends in a finepoint, the actual movement time will be larger than the programmed time.

[`\TriggData1`]

Data type: array of `triggios`

Continues on next page

1 Instructions

1.319 TriggLIOs - Linear robot movements with I/O events

RobotWare Base

Continued

Variable (array) that refers to trigger conditions and trigger activity. When using this argument, it is possible to set analog output signals, digital output signals and digital group output signals. If using a digital group output signal there is a limitation on 23 signals in the group.

[\TriggData2]

Data type: array of triggstrgo

Variable (array) that refers to trigger conditions and trigger activity. When using this argument, it is possible to set digital group output signals that consists of 32 signals in the group and can have a maximum set value of 4294967295. Only digital group output signals can be used.

[\TriggData3]

Data type: array of triggiosdnum

Variable (array) that refers to trigger conditions and trigger activity. When using this argument, it is possible to set analog output signals, digital output signals and digital group output signals that consists of 32 signals in the group and can have a maximum set value of 4294967295.

Zone

Data type: zonedata

Zone data for the movement. Zone data describes the size of the generated corner path.

[\Inpos]

In position

Data type: stoppoint data

This argument is used to specify the convergence criteria for the position of the robot's TCP in the stop point. The stop point data substitutes the zone specified in the `Zone` parameter.

Tool

Data type: tooldata

The tool in use when the robot moves. The tool center point is the point that is moved to the specified destination point.

[\WObj]

Work Object

Data type: wobjdata

The work object (object coordinate system) to which the robot position in the instruction is related.

This argument can be omitted and if it is then the position is related to the world coordinate system. If, on the other hand, a stationary TCP or coordinated external axes are used this argument must be specified in order for a circle relative to the work object to be executed.

[\Corr]

Correction

Continues on next page

Data type: `switch`

Correction data written to a corrections entry by the instruction `CorrWrite` will be added to the path and destination position if this argument is present.

The RobotWare option *Path Offset* is required when using this argument.

[`\TLoad`]

Total load

Data type: `loaddata`

The `\TLoad` argument describes the total load used in the movement. The total load is the tool load together with the payload that the tool is carrying. If the `\TLoad` argument is used, then the `loaddata` in the current `tooldata` is not considered.

If the `\TLoad` argument is set to `load0`, then the `\TLoad` argument is not considered and the `loaddata` in the current `tooldata` is used instead.

To be able to use the `\TLoad` argument it is necessary to set the value of the system parameter `ModalPayloadMode` to 0. If `ModalPayloadMode` is set to 0, it is no longer possible to use the instruction `GripLoad`.

The total load can be identified with the service routine `LoadIdentify`. If the system parameter `ModalPayloadMode` is set to 0, the operator has the possibility to copy the `loaddata` from the tool to an existing or new `loaddata` persistent variable when running the service routine.

It is possible to test run the program without any payload by using a digital input signal connected to the system input `SimMode` (Simulated Mode). If the digital input signal is set to 1, the `loaddata` in the optional argument `\TLoad` is not considered, and the `loaddata` in the current `tooldata` is used instead.



Note

The default functionality to handle payload is to use the instruction `GripLoad`. Therefore the default value of the system parameter `ModalPayloadMode` is 1.

Program execution

See the instruction `MoveL` for information about linear movement.

With the instruction `TriggLIos` it is possible to setup 1-50 different trigger activities on I/O signals along a path from A to B. The signals that can be used are digital output signals, digital group output signals and analog output signals. The trigger conditions are fulfilled either at a certain distance before the end point of the instruction, or at a certain distance after the start point of the instruction.

The instruction requires use of either `TriggData1`, `TriggData2` or `TriggData3` argument or all three of them. Use of any of the triggs is optional though. To inhibit use of a trigg the component used can be set to `FALSE` in the array element of the data types `triggios/triggstrgo/triggiosdnum`. If no array element is in use, then the `TriggLIos` instruction will behave as a `MoveL`, and no I/O activities will be carried out.

If stepping the program forward, the I/O activities are carried out. During stepping the execution backwards, no I/O activities at all are carried out.

Continues on next page

1 Instructions

1.319 TriggLIos - Linear robot movements with I/O events

RobotWare Base

Continued

If setting component `EquipLag` in `TriggData1`, `TriggData2` or `TriggData3` argument to a negative time (delay), the I/O signal can be set after the destination point (`ToPoint`).

If using the argument `TriggData2` or `TriggData3` it is possible to use values up to 4294967295, which is the maximum value a group of digital signals can have (32 signals in a group signal is max for the system).

Error handling

The following recoverable errors are generated and can be handled in an error handler. The system variable `ERRNO` will be set to:

Name	Cause of error
<code>ERR_NORUNUNIT</code>	There is no contact with the I/O device.
<code>ERR_GO_LIM</code>	The programmed <code>setvalue</code> argument for the specified digital group output signal <code>signalname</code> is outside limits. (Declared in <code>TriggData1</code> , <code>TriggData2</code> or <code>TriggData3</code>).
<code>ERR_AO_LIM</code>	The programmed <code>setvalue</code> argument for the specified analog output signal <code>signalname</code> is outside limits. (Declared in <code>TriggData1</code> or <code>TriggData3</code>).
<code>ERR_CONC_MAX</code>	The number of movement instructions in succession using argument <code>\Conc</code> has been exceeded.

More examples

More examples of how to use the instruction `TriggLIos` are illustrated below.

Example 1

```
VAR triggios mytriggios{3}:=[TRUE, 3, TRUE, 0, "go1", 55, 0],
    [TRUE, 15, TRUE, 0, "ao1", 10, 0], [TRUE, 3, FALSE, 0, "do1",
    1, 0]];
...
MoveL p1, v500, z50, gun1;
TriggLIos p2, v500, \TriggData1:=mytriggios, z50, gun1;
MoveL p3, v500, z50, gun1;
```

The digital group output signal `go1` will be set to value 55 3 mm from `p1`. Analog output signal will be set to value 10 15 mm from `p1`. Digital output signal `do1` will be set 3 mm from `ToPoint p2`.

Example 2

```
VAR triggios mytriggios{3}:=[TRUE, 3, TRUE, 0, "go1", 55, 0],
    [TRUE, 15, TRUE, 0, "ao1", 10, 0], [TRUE, 3, FALSE, 0, "do1",
    1, 0]];
VAR triggstrgo mytriggstrgo{3}:=[TRUE, 3, TRUE, 0, "go2", "1",
    0], [TRUE, 15, TRUE, 0, "go2", "800000", 0], [TRUE, 4, FALSE,
    0, "go2", "4294967295", 0]];
VAR triggiosdnum mytriggiosdnum{3}:=[TRUE, 10, TRUE, 0, "go3",
    4294967295, 0], [TRUE, 10, TRUE, 0, "ao2", 5, 0], [TRUE, 10,
    TRUE, 0, "do2", 1, 0]];
...
MoveL p1, v500, z50, gun1;
```

Continues on next page

1.319 TriggLIos - Linear robot movements with I/O events

RobotWare Base

Continued

```
TriggLIos p2, v500, \TriggData1:=mytriggios \TriggData2:=  
mytriggstrgo \TriggData3:=mytriggiosdnum, z50, gun1;  
MoveL p3, v500, z50, gun1;
```

The digital group output signal `go1` will be set to value 55 3 mm from `p1`. Analog output signal `ao1` will be set to value 10 15 mm from `p1`. Digital output signal `do1` will be set 3 mm from `ToPointp2`. Those position events is setup by variable `mytriggios`. The variable `mytriggstrgo` sets up position events to occur 3 and 15 mm from `p1`. First the signal `go2` is set to 1, then it is set to 800000. The signal will be set to value 4294967295 4 mm from the `ToPoint p2`. This is the maximum value for a 32 bits digital output signal. The variable `mytriggiosdnum` sets up three position events to occur 10 mm from `p1`. First the signal `go3` is set to 4294967295, then `ao2` is set to 5 and last `do2` is set to 1.

Limitations

If the current start point deviates from the usual so that the total positioning length of the instruction `TriggLIos` is shorter than usual (e.g. at the start of `TriggLIos` with the robot position at the end point) it may happen that several or all of the trigger conditions are fulfilled immediately and at the same position. In such cases, the sequence in which the trigger activities are carried out will be undefined. The program logic in the user program may not be based on a normal sequence of trigger activities for an incomplete movement.

The limitation of the number of triggs in the instruction `TriggLIos` is 50 for each programmed instruction. If triggs happen at a closer distance, the system might not handle it. That depends on how the movement is done, TCP speed used and how close the triggs are programmed. Those limitations exists, but it is hard to predict when those problems will occur.

`TriggLIos` cannot be executed in an UNDO handler or RAPID routine connected to any of the following special system events: PowerOn, Stop, QStop, Restart, Reset or Step.

Limitations regarding accuracy

I/O events with distance is intended for flying points (corner path). Using stop points will result in worse accuracy than specified below.

Regarding the accuracy for I/O events with distance and using flying points, the following is applicable when setting a digital output at a specified distance from the start point or end point in the instruction `TriggLIos` or `TriggCIOs`:

- The accuracy specified below is valid when using a positive `equiplag`¹ that is less than 40 ms, which is equivalent to the lag in the robot servo, without changing the system parameter *Event Preset Time*. The lag can vary between different robot types.
- The accuracy specified below is valid when using a positive `equiplag` that is less than the configured *Event Preset Time* in the system parameters.
- The accuracy specified below is not valid when using a positive `equiplag` that is larger than the configured *Event Preset Time* in the system parameters. In this case, an approximate method is used in which the dynamic limitations

Continues on next page

1 Instructions

1.319 TriggLIos - Linear robot movements with I/O events

RobotWare Base

Continued

of the robot are not taken into consideration. Then `SingArea \Wrist` must be used to achieve an acceptable accuracy.

- The accuracy specified below is valid when using a negative `equiplag`.

¹ `equiplag` is a dataobject of data type `triggios`

The typical absolute accuracy values for setting digital outputs is: ± 5 ms.

The typical repeat accuracy values for setting digital outputs is: ± 2 ms.

Syntax

```
TriggLIos
  ['\' Conc ',']
  [ToPoint ':='] <expression (IN) of robtarget >
  ['\' ID ':='] <expression (IN) of identno>'],'
  [Speed ':='] <expression (IN) of speeddata>
  ['\' T ':='] <expression (IN) of num>'],'
  ['\' TriggData1 ':='] <array {*} (VAR) of triggios>
  ['\' TriggData2 ':='] <array {*} (VAR) of triggstrgo>
  ['\' TriggData3 ':='] <array {*} (VAR) of triggiosdnum>'],'
  [Zone ':='] <expression (IN) of zonedata>
  ['\' Inpos ':='] <expression (IN) of stoppointdata>'],'
  [Tool ':='] <persistent (PERS) of tooldata>
  ['\' WObj ':='] <persistent (PERS) of wobjdata>]
  ['\' Corr]
  ['\' TLoad ':='] <persistent (PERS) of loaddata>]';'
```

Related information

For information about	See
Joint robot movements with I/O events	TriggJIOs - Joint robot movements with I/O events on page 943
Storage of trigg conditions and trigger activity	triggios - Positioning events, trigg on page 1786
Storage of trigg conditions and trigger activity for digital signal group consisting of 32 signals	triggstrgo - Positioning events, trigg on page 1794
Storage of trigg conditions and trigger activity	triggiosdnum - Positioning events, trigg on page 1789
Allocation of event objects	<i>Technical reference manual - System parameters</i>
Linear movement	<i>Technical reference manual - RAPID Overview</i>
Motion in general	<i>Technical reference manual - RAPID Overview</i>
Definition of load	loaddata - Load data on page 1682
Example of how to use <code>TLoad</code> , Total Load.	MoveL - Moves the robot linearly on page 458
Defining the payload for a robot	GripLoad - Defines the payload for a robot on page 243
LoadIdentify, load identification service routine	<i>Operating manual - IRC5 with FlexPendant</i>

Continues on next page

For information about	See
System input signal <i>SimMode</i> for running the robot in simulated mode without payload	<i>Technical reference manual - System parameters</i>
System parameter <i>ModalPayloadMode</i> for activating and deactivating payload	<i>Technical reference manual - System parameters</i>
<i>Path Offset</i>	<i>Application manual - Controller software IRC5</i>

1 Instructions

1.320 TriggRampAO - Define a fixed position ramp AO event on the path *RobotWare Base*

1.320 TriggRampAO - Define a fixed position ramp AO event on the path

Usage

`TriggRampAO` (*Trigg Ramp Analog Output*) is used to define conditions and actions for ramping up or down analog output signal value at a fixed position along the robot's movement path with possibility to do time compensation for the lag in the external equipment.

The data defined is used for implementation in one or more subsequent `TriggL`, `TriggC`, or `TriggJ` instructions. Beside these instructions, `TriggRampAO` can also be used in `CapL` or `CapC` instructions.

The type of trig actions connected to the same `TriggL/C/J` instruction can be `TriggRampAO` or any of `TriggIO`, `TriggEquip`, `TriggSpeed`, `TriggInt`, or `TriggCheckIO` instructions. Any type of combination is allowed except that only one `TriggSpeed` action on the same signal in the same `TriggL/C/J` instruction is allowed.

This instruction can only be used in the main task `T_ROB1` or, if in a *MultiMove* system, in Motion tasks.

Basic examples

The following example illustrates the instruction `TriggRampAO`:

See also [More examples on page 963](#).

Example 1

```
VAR triggdata ramp_up;
...
TriggRampAO ramp_up, 0 \Start, 0.1, aolaser1, 8, 15;
MoveL p1, v200, z10, gun1;
TriggL p2, v200, ramp_up, z10, gun1;
```

The analog signal `aolaser1` will start ramping up its logical value from current value to the new value 8, when the TCP of the tool `gun1` is 0.1 s before the center of the corner path at `p1`. The whole ramp-up will be done while the robot moves 15 mm.

Example 2

```
VAR triggdata ramp_down;
...
TriggRampAO ramp_down, 15, 0.1, aolaser1, 2, 10;
MoveL p3, v200, z10, gun1;
TriggL p4, v200, ramp_down, z10, gun1;
```

The analog signal `aolaser1` will start ramping down its logical value from current value to the new value 2, when the TCP of the tool `gun1` is 15 mm plus 0.1 s before the centre of the corner path at `p4`. The whole ramp-down will be done while the robot moves 10 mm.

Arguments

```
TriggRampAO TriggData Distance [\Start] | [\Next] EquipLag AOutput
             SetValue RampLength [\Time] [\Inhib] [\InhibSetValue] [\Mode]
```

Continues on next page

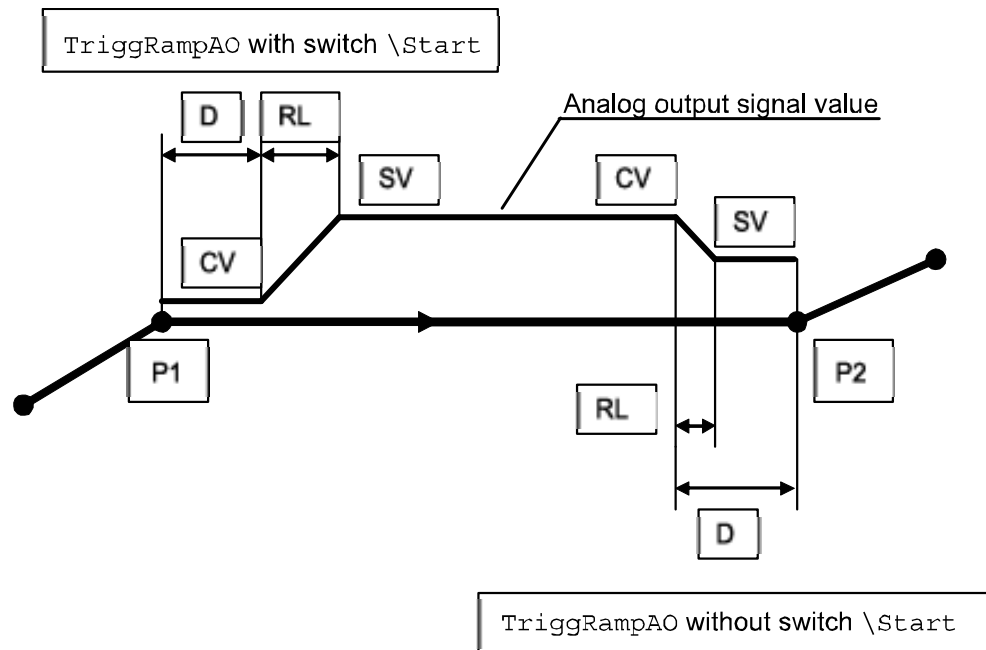

xx0600003433

D	Parameter Distance
RL	Parameter RampLength
CV	Current analog signal Value
SV	Parameter SetValue for the analog signal value
P1	ToPoint for preceding move instruction
P2	ToPoint for actual TrigL/C/J instruction

TriggData

Data type: triggdata

Variable for storing the triggdata returned from this instruction. These triggdata are then used in the subsequent TriggL, TriggC, or TriggJ instructions.

Distance

Data type: num

Defines the distance from the centre of the corner path where the ramp of the analog output shall start.

Specified as the distance in mm (positive value) from the end point (ToPoint) of the movement path (applicable if the argument \Start is not set).

See [Program execution on page 961](#) for further details.

[\Start]

Data type: switch

Used when the distance for the argument Distance starts at the movement start point instead of the end point.

[\Next]

Data type: switch

Continues on next page

1 Instructions

1.320 TriggRampAO - Define a fixed position ramp AO event on the path

RobotWare Base

Continued

Used when the distance for the argument `Distance` is forward towards the next programmed point. If the `Distance` is longer than the distance to the next fine point, the event will be executed at the fine point.

EquipLag

Equipment Lag

Data type: num

Specify the lag for the external equipment in s.

For compensation of external equipment lag, use positive argument value. Positive argument value means that the start of the ramping of the AO signal is done by the robot system at a specified time before the TCP physically reaches the specified distance point in relation to the movement start or end point.

Negative argument value means that starting the ramping of the AO signal is done by the robot system at a specified time after that the TCP has physically passed the specified distance point in relation to the movement start or end point.

The figure shows use of argument `EquipLag`.

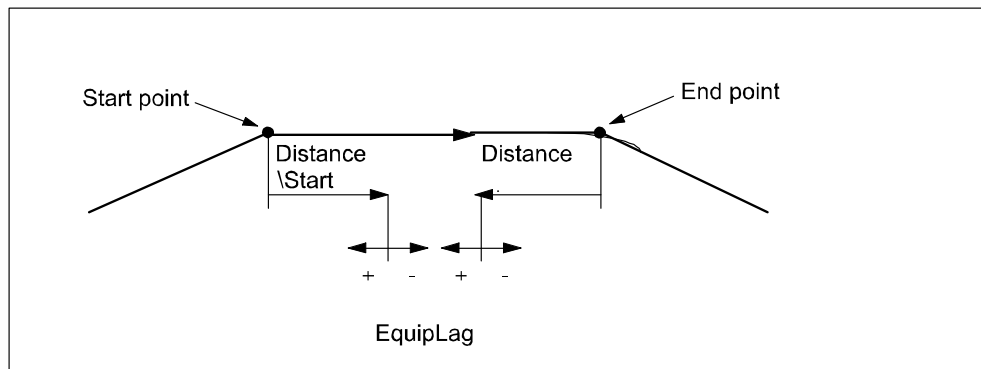

xx0500002262

AOutput

Analog Output

Data type: signalao

The name of the analog output signal.

SetValue

Data type: num

The value to which the analog output signal should be ramped up or down to (must be within the allowed logical range value for the signal). The ramping is started with the current value of the analog output signal.

RampLength

Data type: num

The ramping length in mm along the TCP movement path.

[\Time]

Data type: switch

Continues on next page

1.320 TriggRampAO - Define a fixed position ramp AO event on the path

RobotWare Base

Continued

If used, then the `RampLength` specifies the ramp time in s instead of ramping length.

Must be used, if subsequent `TriggL`, `TriggC`, or `TriggJ` specifies that the total movement should be done on time (argument `\T`) instead of speed.

[`\Inhib`]

Inhibit

Data type: `bool`

The name of a persistent variable flag for inhibiting the setting of the signal at runtime.

If this optional argument is used and the actual value of the specified flag is `TRUE` at the position-time for start ramping the I/O signal then the specified signal (`AOutput`) will be set to 0.

[`\InhibSetValue`]

InhibitSetValue

Data type: `bool`, `num` or `dnum`

The name of a persistent variable of the data type `bool`, `num` or `dnum` or any alias of those three base data types.

This optional argument can only be used together with optional argument `Inhib`.

If this optional argument is used and the value of the persistent variable flag used in optional argument `Inhib` is `TRUE` at the position-time for setting the signal, the value of the persistent variable used in optional argument `InhibSetValue` is read and the value is used for setting of the `AOutput` signal.

If using a boolean persistent variable, the value `TRUE` is translated to value 1, and `FALSE` is translated to value 0.

[`\Mode`]

Data type: `triggmode`

Is used to specify different action modes when defining triggers.

Program execution

When running the instruction `TriggRampAO`, the trigger condition is stored in the specified variable for the argument `TriggData`.

Afterwards, when one of the instructions `TriggL`, `TriggC` or `TriggJ` is executed, the following are applicable with regard to the definitions in `TriggRampAO`:

The table describes the distance specified in the argument `Distance`:

Linear movement	The straight line distance
Circular movement	The circle arc length
Non-linear movement	The approximate arc length along the path (to obtain adequate accuracy, the distance should not exceed one half of the arc length).

Continues on next page

1 Instructions

1.320 TriggRampAO - Define a fixed position ramp AO event on the path

RobotWare Base

Continued

The figure shows ramping of AO in a corner path.

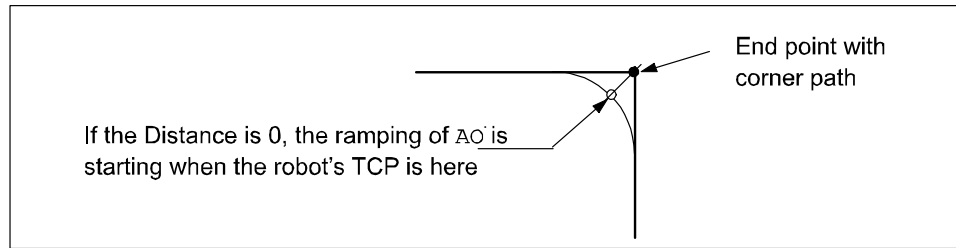

xx0600003439

Program execution characteristics of TriggRampAO connected to any TriggL/C/J:

- The ramping of the AO is started when the robot reaches the specified `Distance` point on the robot path (with compensation for the specified `EquipLag`)
- The ramping function will be performed during a time period calculated from specified `RampLength` and the programmed TCP speed. The calculation takes into consideration `VelSet`, manual speed override, and max. 250 mm/s in MAN mode but not any other speed limitations.
- Updating of the AO signal value from start (current read) value to specified `SetValue` will be done each 10 ms resulting in a staircase form. If the calculated ramp time or specified ramp time is greater than 0.5 s then the ramping frequency will slow down:
 - ≤ 0.5 s gives max. 50 step each 10 ms
 - ≤ 1 s gives max. 50 steps each 20 ms
 - ≤ 1.5 s gives max. 50 steps each 30 ms and so on

The TriggRampAO action is also done in FWD step but not in BWD step mode.

At any type of stop (ProgStop, Emergency Stop ...) if the ramping function is active for the occasion:

- if ramping up, the AO is set to an old value momentarily.
- if ramping down, the AO is set to the new `SetValue` momentarily.

Error handling

The following recoverable errors are generated and can be handled in an error handler. The system variable `ERRNO` will be set to:

Name	Cause of error
<code>ERR_AO_LIM</code>	The programmed <code>SetValue</code> argument for the specified analog output signal <code>AOutput</code> is out of limit.
<code>ERR_NO_ALIASIO_DEF</code>	The signal variable is a variable declared in RAPID and it has not been connected to an I/O signal defined in the I/O configuration with instruction <code>AliasIO</code> .

Continues on next page

More examples

More examples of how to use the instruction `TriggRampAO` are illustrated below.

Example 1

```
VAR triggdata ramp_up;
VAR triggdata ramp_down;
...
TriggRampAO ramp_up, 0 \Start, 0.1, aolaser1, 8, 15;
TriggRampAO ramp_down, 15, 0.1, aolaser1, 2, 10;
MoveL p1, v200, z10, gun1;
TriggL p2, v200, ramp_up, \T2:=ramp_down, z10, gun1;
```

In this example both the ramp-up and ramp-down of the AO is done in the same `TriggL` instruction on the same movement path. It works without any interference of the AO settings if the movement path is long enough.

The analog signal `aolaser1` will start ramping up its logical value from the current value to the new value 8 when the TCP of the tool `gun1` is 0.1 s before the center of the corner path at `p1`. The whole ramp-up will be done while the robot moves 15 mm.

The analog signal `aolaser1` will start ramping down its logical value from the current value 8 to the new value 2 when the TCP of the tool `gun1` is 15 mm plus 0.1 s before the centre of the corner path at `p2`. The whole ramp-up will be done while the robot moves 10 mm.

Limitations

The analog output signal value will not be compensated for lower TCP-speed in corner path or during other acceleration or deceleration phases (the AO is not TCP speed proportional).

Only the start point of the AO ramping will be done at the specified position on the path. The ramping up or down will be done with “dead calculation”, with high accuracy:

- At constant speed the deviation for the end of the AO ramping compared with the specified will be low.
- During acceleration or deceleration phases, such as near stop points, the deviation will be higher.
- Recommendation: use corner paths before ramp up and after ramp down.

If use of two or several `TriggRampAO` on the same analog output signal and connected to the same `TriggL/C/J` instruction and both or several `RampLength` are located on the same part of the robot path then the AO settings will interact with each other.

The position (+/- time) related ramp AO event will start when the previous `ToPoint` is passed if the specified `Distance` from the actual `ToPoint` is not within the length of movement for the current `TriggL/C/J` instruction. The position (+/- time) related ramp AO event will start when the actual `ToPoint` is passed if the specified `Distance` from the previous `ToPoint` is not within the length of movement for the current `TriggL/C/J` instruction (with argument `\Start`).

Continues on next page

1 Instructions

1.320 TriggRampAO - Define a fixed position ramp AO event on the path

RobotWare Base

Continued

No support for restart of the ramping AO function after any type of stop (ProgStop, Emergency Stop ...).

At Power Fail Restart the TriggL/C/J instruction is started from the beginning of the current Power Fail position.

TriggRampAO cannot be executed in an UNDO handler or RAPID routine connected to any of the following special system events: PowerOn, Stop, QStop, Restart, Reset or Step.

Syntax

```
TriggRampAO
  [ TriggData ':= ' ] < variable (VAR) of triggdata > ','
  [ Distance ':= ' ] < expression (IN) of num >
  [ '\ ' Start ] | [ '\ ' Next ] ','
  [ EquipLag ':= ' ] < expression (IN) of num > ','
  [ AOutput ':= ' ] < variable (VAR) of signalao > ','
  [ SetValue ':= ' ] < expression (IN) of num > ','
  [ RampLength ':= ' ] < expression (IN) of num > ','
  [ '\ ' Time ]
  [ '\ ' Inhib ':= ' < persistent (PERS) of bool > ]
  [ '\ ' InhibSetValue ':= ' < persistent (PERS) of anytype > ]
  [ '\ ' Mode ':= ' < expression (IN) of triggmode > ] ';'

```

Related information

For information about	See
Use of triggers	TriggL - Linear robot movements with events on page 935 TriggC - Circular robot movement with events on page 891 TriggJ - Axis-wise robot movements with events on page 927
Definition of other triggs	TriggEquip - Define a fixed position and time I/O event on the path on page 910
Storage of triggdata	triggdata - Positioning events, trigg on page 1785 triggmode - Trigg action mode on page 1791
Set of analog output signal	SetAO - Changes the value of an analog output signal on page 694 signalxx - Digital and analog signals on page 1747
Configuration of event preset time	Technical reference manual - System parameters

1.321 TriggSpeed - Defines TCP speed proportional analog output with fixed position-time scale event

RobotWare Base

1.321 TriggSpeed - Defines TCP speed proportional analog output with fixed position-time scale event

Usage

`TriggSpeed` is used to define conditions and actions for control of an analog output signal with output value proportional to the actual TCP speed. The beginning, scaling, and ending of the analog output can be specified at a fixed position-time along the robot's movement path. It is possible to use time compensation for the lag in the external equipment for the beginning, scaling, and ending of the analog output and also for speed dips of the robot.

The data defined is used in one or more subsequent `TriggL`, `TriggC`, or `TriggJ` instructions.

This instruction can only be used in the main task `T_ROB1`, if in a MultiMove System, in Motion tasks.

Basic examples

The following example illustrates the instruction `TriggSpeed`:

See also [More examples on page 971](#).

Example 1

```
VAR triggdata glueflow;
TriggSpeed glueflow, 0, 0.05, glue_ao, 0.8\DipLag:=0.04
  \ErrDO:=glue_err;
TriggL p1, v500, glueflow, z50, gun1;
TriggSpeed glueflow, 10, 0.05, glue_ao, 1;
TriggL p2, v500, glueflow, z10, gun1;
TriggSpeed glueflow, 0, 0.05, glue_ao, 0;
TriggL p3, v500, glueflow, z50, gun1;
```

The figure below illustrates an example of `TriggSpeed` sequence

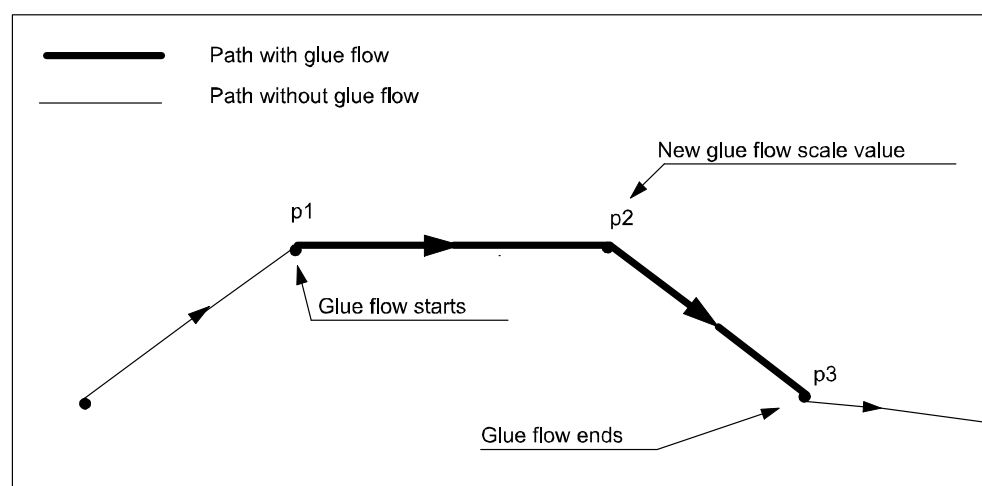

xx0500002329

The glue flow (analog output `glue_ao`) with scale value 0.8 starts when TCP is 0.05 s before point `p1`, new glue flow scale value 1 when TCP is 10 mm plus 0.05

Continues on next page

1 Instructions

1.321 TriggSpeed - Defines TCP speed proportional analog output with fixed position-time scale event
RobotWare Base
Continued

s before point `p2`, and the glue flow ends (scale value 0) when TCP is 0.05 s before point `p3`.

Any speed dip by the robot is time compensated in such a way that the analog output signal `glue_ao` is affected 0.04 s before the TCP speed dip occurs.

If overflow of the calculated logical analog output value in `glue_ao` then the digital output signal `glue_err` is set. If there is no more overflow then `glue_err` is reset.

Arguments

```
TriggSpeed TriggData Distance [\Start] | [\Next] ScaleLag AOp
          ScaleValue [\DipLag] [\ErrDO] [\Inhib] [\InhibSetValue]
          [\Mode]
```

TriggData

Data type: `triggdata`

Variable for storing the `triggdata` returned from this instruction. These `triggdata` are then used in the subsequent `TriggL`, `TriggC`, or `TriggJ` instructions.

Distance

Data type: `num`

Defines the position on the path for change of the analog output value.

Specified as the distance in mm (positive value) from the end point of the movement path (applicable if the argument `\Start` is not set).

See [Program execution on page 969](#) for further details.

[`\Start`]

Data type: `switch`

Used when the distance for the argument `Distance` starts at the movement start point instead of the end point.

[`\Next`]

Data type: `switch`

Used when the distance for the argument `Distance` is forward towards the next programmed point. If the `Distance` is longer than the distance to the next fine point, the event will be executed at the fine point.

ScaleLag

Data type: `num`

Specify the lag as time in s (positive value) in the external equipment for change of the analog output value (starting, scaling, and ending).

For compensation of external equipment lag, this argument value means that the analog output signal is set by the robot at a specified time before the TCP physically reaches the specified distance in relation to the movement's start or end point.

The argument can also be used to extend the analog output beyond the end point. Set the time in seconds that the robot shall keep the analog output. Set the time with a negative sign. The limit is -0.10 seconds.

Continues on next page

1.321 TriggSpeed - Defines TCP speed proportional analog output with fixed position-time scale event

RobotWare Base

Continued

The figure below illustrates the use of argument `ScaleLag`

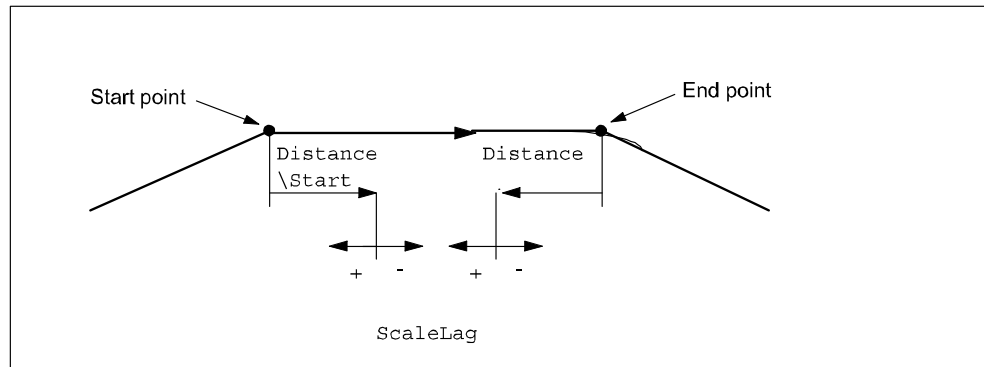

xx0500002330

AOp

Analog Output**Data type:** `signalao`

The name of the analog output signal.

ScaleValue

Data type: `num`

The scale value for the analog output signal.

The physical output value for the analog signal is calculated by the robot:

- Logical output value = Scale value * Actual TCP speed in mm/s.
- Physical output value = According definition in configuration for actual analog output signal with above Logical output value as input.

[`\DipLag`]**Data type:** `num`

Specify the lag as time in s (positive value) for the external equipment when changing of the analog output value because of robot speed dips.

For compensation of external equipment lag, this argument value means that the analog output signal is set by the robot at a specified time before the TCP speed dip occurs.

**Note**

This argument can only be used by the robot for the first `TriggSpeed` (in combination with one of `TriggL`, `TriggC`, or `TriggJ`) in a sequence of several `TriggSpeed` instructions. The first specified argument value is valid for all the following `TriggSpeed` in the sequence.

[`\ErrDO`]**Error Digital Output****Data type:** `signaldo`

The name of the digital output signal for reporting analog value overflow.

Continues on next page

1 Instructions

1.321 TriggSpeed - Defines TCP speed proportional analog output with fixed position-time scale event
RobotWare Base
Continued

If during movement the calculation of the logical analog output value for signal in argument `AOp` results in overflow because of overspeed then this signal is set and the physical analog output value is reduced to the maximum value. If there is no more overflow then the signal is reset.



Note

This argument can only be used by the robot for the 1st `TriggSpeed` (in combination with one of `TriggL`, `TriggC`, or `TriggJ`) in a sequence of several `TriggSpeed` instructions. The 1st given argument value is valid for all the following `TriggSpeed` in the sequence.

[`\Inhib`]

Inhibit

Data type: `bool`

The name of a persistent variable flag for inhibiting the setting of the analog signal at runtime.

If this optional argument is used and the actual value of the specified flag is `TRUE` at the time for setting the analog signal then the specified signal `AOp` will be set to 0 instead of a calculated value.



Note

This argument can only be used by the robot for the 1st `TriggSpeed` (in combination with one of `TriggL`, `TriggC`, or `TriggJ`) in a sequence of several `TriggSpeed` instructions. The 1st given argument value is valid for all the following `TriggSpeed` in the sequence.

[`\InhibSetValue`]

InhibitSetValue

Data type: `bool`, `num` or `dnum`

The name of a persistent variable of the data type `bool`, `num` or `dnum` or any alias of those three base data types.

This optional argument can only be used together with optional argument `Inhib`.

If this optional argument is used and the value of the persistent variable flag used in optional argument `Inhib` is `TRUE` at the position-time for setting the signal, the value of the persistent variable used in optional argument `InhibSetValue` is read and the value is used for setting of the `AOp` signal.

Continues on next page

1.321 TriggSpeed - Defines TCP speed proportional analog output with fixed position-time scale event

RobotWare Base

Continued

If using a boolean persistent variable, the value TRUE is translated to value 1, and FALSE is translated to value 0.



Note

This argument can only be used by the robot for the 1st TriggSpeed (in combination with one of TriggL, TriggC, or TriggJ) in a sequence of several TriggSpeed instructions. The 1st given argument value is valid for all the following TriggSpeed in the sequence.

[\Mode]

Data type: triggmode

Is used to specify different action modes when defining triggers.



Note

This argument can only be used by the robot for the 1st TriggSpeed (in combination with one of TriggL, TriggC, or TriggJ) in a sequence of several TriggSpeed instructions. The 1st given argument value is valid for all the following TriggSpeed in the sequence.

Program execution

When running the instruction TriggSpeed the trigger condition is stored in the specified variable for the argument TriggData.

Afterwards, when one of the instructions TriggL, TriggC, or TriggJ is executed then the following are applicable with regard to the definitions in TriggSpeed:

For the distance specified in the argument Distance, see the table below:

Linear movement	The straight line distance
Circular movement	The circle arc length
Non-linear movement	The approximate arc length along the path (to obtain adequate accuracy, the distance should not exceed one half of the arc length).

The figure below illustrates the fixed position-time scale value event on a corner path.

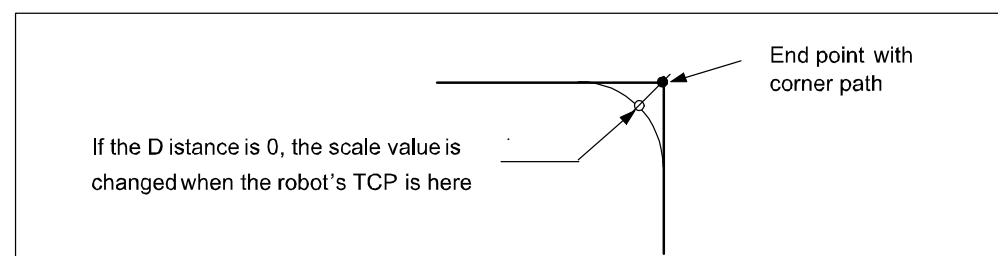

xx0500002331

The position-time related scale value event will be generated when the start point (end point) is passed if the specified distance from the end point (start point) is not within the length of the movement of the current instruction (TriggL, TriggC, or TriggJ).

Continues on next page

1 Instructions

1.321 TriggSpeed - Defines TCP speed proportional analog output with fixed position-time scale event RobotWare Base Continued

The 1:st `TriggSpeed` used by one of `TriggL`, `TriggC`, or `TriggJ` instruction will internally in the system create a process with the same name as the analog output signal. The same process will be used by all succeeding `TriggL`, `TriggC`, or `TriggJ` which refers to same signal name and setup by a `TriggSpeed` instruction. The process will immediately set the analog output to 0, in the event of a program emergency stop. In the event of a program stop, the analog output signal will stay TCP-speed proportional until the robot stands still. The process keeps “alive” and ready for a restart. When the robot restarts, the signal is TCP-speed proportional directly from the start.

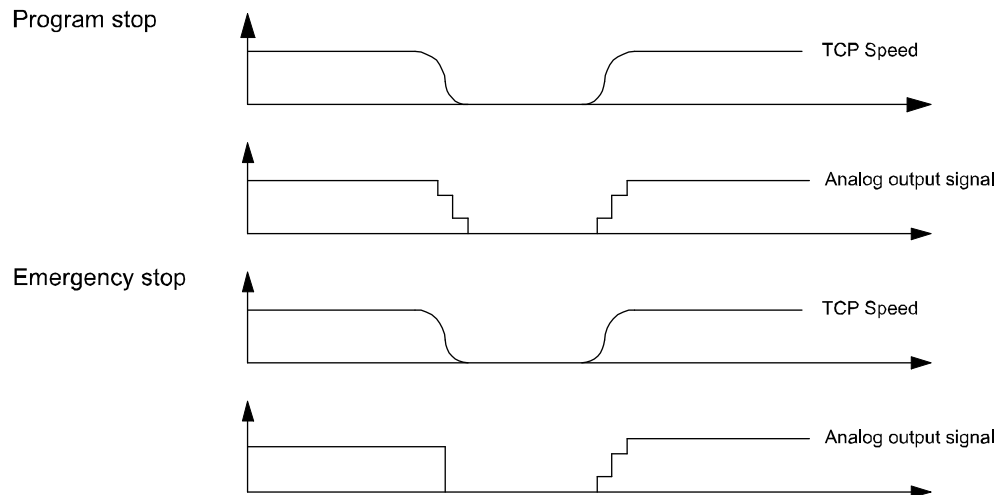

xx0500002332

The process will “die” after handling a scale event with value 0 if no succeeding `TriggL`, `TriggC`, or `TriggJ` is in the queue at the time.

Error handling

The following recoverable errors are generated and can be handled in an error handler. The system variable `ERRNO` will be set to:

Name	Cause of error
<code>ERR_NO_ALIASIO_DEF</code>	The signal variable is a variable declared in RAPID. It has not been connected to an I/O signal defined in the I/O configuration with instruction <code>AliasIO</code> .

Given two consecutive movement orders with `TriggL/TriggSpeed` instructions. A negative value in parameter `ScaleLag` makes it possible to move the scale event from the first movement order to the beginning of the second movement order. If

Continues on next page

1.321 TriggSpeed - Defines TCP speed proportional analog output with fixed position-time scale event

*RobotWare Base**Continued*

the second movement order scales at the beginning then there is no control if the two scales interfere.



xx0500002334

More examples

More examples of the instruction `TriggSpeed` are illustrated below.

Example 1

```
VAR triggdata flow;
TriggSpeed flow, 10 \Start, 0.05, flowsignal, 0.5 \DipLag:=0.03;
MoveJ p1, v1000, z50, tool1;
TriggL p2, v500, flow, z50, tool1;
```

The analog output signal `flowsignal` is set to a logical value = $(0.5 * \text{actual TCP speed in mm/s})$ 0.05 s before the TCP passes a point located 10 mm after the start point `p`. The output value is adjusted to be proportional to the actual TCP speed during the movement to `p2`.

...

```
TriggL p3, v500, flow, z10, tool1;
```

The robot moves from `p2` to `p3` with the analog output value proportional to the actual TCP speed. The analog output value will be decreased at time 0.03 s before the robot reduces the TCP speed during the passage of the corner path `z10`.

Example 2

```
VAR triggdata glueflow;
VAR triggdata glueflowend;
TriggSpeed glueflow, 0, 0.05, glue_ao, 1;
TriggSpeed glueflowend, 25 \Next, 0, glue_ao, 0;
TriggL p1, v500, glueflow, z50, gun1;
TriggL p2, v500, glueflow, z50, gun1;
TriggL p3, v500, glueflowend, z50, gun1;
MoveL p4, v500, z50, gun1;
```

Continues on next page

1 Instructions

1.321 TriggSpeed - Defines TCP speed proportional analog output with fixed position-time scale event
RobotWare Base
Continued

The figure below illustrates an example of TriggSpeed sequence and use of \Next argument

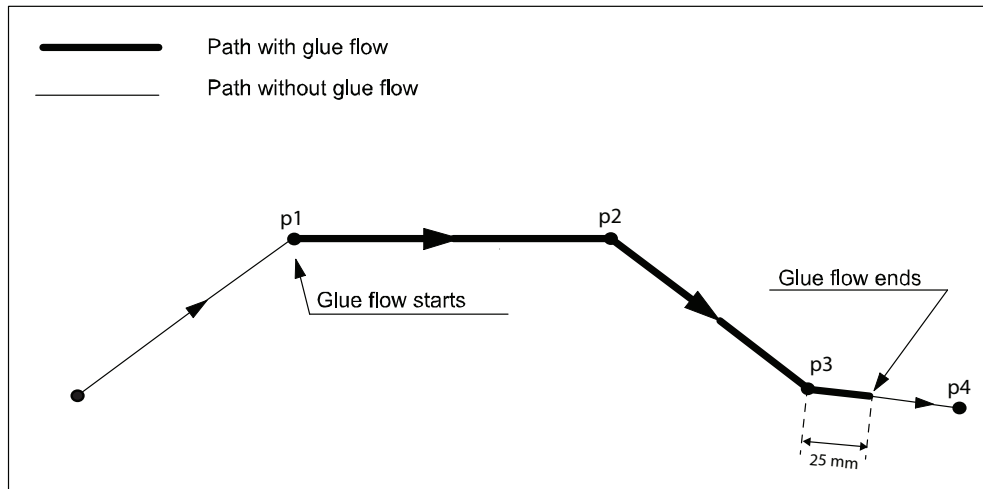

xx1800000010

The glue flow (analog output `glue_ao`) with scale value 0.8 starts when TCP is 0.05 s before point p1. The glue flow ends (scale value 0) when TCP is 25 mm after point p3.

Related system parameters

The system parameter *Event Preset Time* is used to delay the robot to make it possible to activate/control the external equipment before the robot runs through the position.

The table below illustrates the recommendation for setup of system parameter *Event Preset Time*, where typical Servo Lag is 0.040 s..

ScaleLag	DipLag	Required Event Preset Time to avoid runtime execution error	Recommended Event Preset Time to obtain best accuracy
ScaleLag > DipLag	Always	DipLag, if DipLag > ServoLag	ScaleLag in s plus 0.090 s
ScaleLag < DipLag	DipLag < Servo Lag	- " -	0.090 s
- " -	DipLag > Servo Lag	- " -	DipLag in s plus 0.030 s

Limitations

The limitations for the instruction TriggSpeed are illustrated below.

Accuracy of position-time related scale value event

Typical absolute accuracy values for scale value events ± 5 ms.

Typical repeat accuracy values for scale value events ± 2 ms.

Accuracy of TCP speed dips adaptation (deceleration - acceleration phases)

Typical absolute accuracy values for TCP speed dips adaptation ± 5 ms.

Continues on next page

1.321 TriggSpeed - Defines TCP speed proportional analog output with fixed position-time scale event

RobotWare Base

Continued

Typical repeat accuracy values for TCP speed dips adaptation ± 2 ms (the value depends of the configured *Path resolution*).

Negative ScaleLag

If a negative value on parameter `ScaleLag` is used to move the zero scaling over to the next movement order then the analog output signal will not be reset if a program stop occurs. An emergency stop will always reset the analog signal.

The analog signal is no longer TCP-speed proportional after the end point on the movement order.

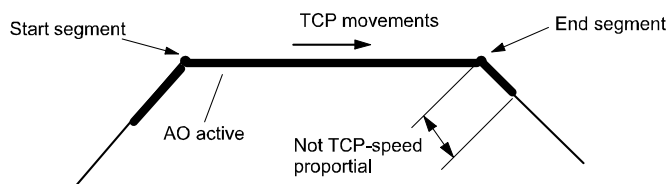

xx0500002333

`TriggSpeed` cannot be executed in an UNDO handler or RAPID routine connected to any of the following special system events: **PowerOn**, **Stop**, **QStop**, **Restart**, **Reset** or **Step**.

Syntax

```
TriggSpeed
[ TriggData ::= ] < variable (VAR) of triggdata> ','
[ Distance ::= ] < expression (IN) of num>
[ '\ Start ] | [ '\ Next ] ','
[ ScaleLag ::= ] < expression (IN) of num> ','
[ AOp ::= ] < variable (VAR) of signalao> ','
[ ScaleValue ::= ] < expression (IN) of num>
[ '\ DipLag ::= ] < expression (IN) of num> ]
[ '\ ErrDO ::= ] < variable (VAR) of signaldo> ]
[ '\ Inhib ::= ] < persistent (PERS) of bool > ]
[ '\ InhibSetValue ::= ] < persistent (PERS) of anytype> ]
[ '\ Mode ::= ] < expression (IN) of triggmode> ] ';'

```

Related information

For information about	See
Use of triggers	TriggL - Linear robot movements with events on page 935 TriggC - Circular robot movement with events on page 891 TriggJ - Axis-wise robot movements with events on page 927
Definition of other triggs	TriggIO - Define a fixed position or time I/O event near a stop point on page 921 TriggInt - Defines a position related interrupt on page 916 TriggEquip - Define a fixed position and time I/O event on the path on page 910

Continues on next page

1 Instructions

1.321 TriggSpeed - Defines TCP speed proportional analog output with fixed position-time scale event
RobotWare Base

Continued

For information about	See
Storage of triggdata	triggdata - Positioning events, trigg on page 1785 triggmode - Trigg action mode on page 1791
Configuration of Event preset time	<i>Technical reference manual - System parameters</i>
<i>Advanced RAPID</i>	<i>Application manual - Controller software IRC5</i>

1.322 TriggStopProc - Generate restart data for trigg signals at stop

Usage

The instruction `TriggStopProc` creates an internal supervision process in the system for zero setting of specified process signals and the generation of restart data in a specified persistent variable at every program stop (`STOP`) or emergency stop (`QSTOP`) in the system.

`TriggStopProc` and the data type `restartdata` are intended to be used for restart after program stop (`STOP`) or emergency stop (`QSTOP`) of own process instructions defined in `RAPID` (`NOSTEPIN` routines).

It is possible in a user defined `RESTART` event routine to analyze the current restart data, step backwards on the path with instruction `StepBwdPath`, and activate suitable process signals before the movement restarts.

This instruction can only be used in the main task `T_ROB1` or, if in a *MultiMove* system, in any motion tasks.

Note for *MultiMove* system that only one `TriggStopProc` support process with the specified shadow signal name (argument `ShadowDO`) can be active in the system at the same time. It means that `TriggStopProc` supervises program stop or emergency stop in the program task where it was last executed.

Arguments

```
TriggStopProc RestartRef [\DO] [\G01] [\G02] [\G03] [\G04] ShadowDO
```

RestartRef

Restart Reference

Data type: `restartdata`

The persistent variable in which restart data will be available after every stop of program execution.

[\DO1]

Digital Output 1

Data type: `signaldo`

The signal variable for a digital process signal to be set to zero and supervised in restart data when program execution is stopped.

[\G01]

Group Output 1

Data type: `signalgo`

The signal variable for a digital group process signal to be set to zero and supervised in restart data when program execution is stopped.

[\G02]

Group Output 2

Data type: `signalgo`

The signal variable for a digital group process signal to be set to zero and supervised in restart data when program execution is stopped.

Continues on next page

1 Instructions

1.322 TriggStopProc - Generate restart data for trigg signals at stop

RobotWare Base

Continued

[\GO3]

Group Output 3

Data type: signalgo

The signal variable for a digital group process signal to be set to zero and supervised in restart data when program execution is stopped.

[\GO4]

Group Output 4

Data type: signalgo

The signal variable for a digital group process signal to be set to zero and supervised in restart data when program execution is stopped.

At least one of the optional parameters D01, GO1 ... GO4 must be used.

ShadowDO

Shadow Digital Output

Data type: signaldo

The signal variable for the digital signal, which must mirror whether or not the process is active along the robot path.

This signal will not be set to zero by the process TriggStopProc at STOP or QSTOP, but its values will be mirrored in restartdata.

Program execution

Setup and execution of TriggStopProc

TriggStopProc must be called from both:

- the START event routine or in the unit part of the program (set PP to main, kill the internal process for TriggStopProc)
- the POWERON event routine (power off, kill the internal process for TriggStopProc)

The internal name of the process for TriggStopProc is the same as the signal name in the argument ShadowDO. If TriggStopProc, with the same signal name in argument ShadowDO, is executed twice from the same or another program task then only the last executed TriggStopProc will be active.

Execution of TriggStopProc only starts the supervision of I/O signals at STOP and QSTOP.

Program stop STOP

The process TriggStopProc comprises the following steps:

- 1 Wait until the robot stands still on the path.
- 2 Store the current value (prevalue according to restartdata) of all used process signals. Zero sets all used process signals except ShadowDO.
- 3 Do the following during the next time slot, about 500 ms, if some process signals change their value during this time:
 - Store the current value again (postvalue according to restartdata)
 - Set that signal to zero except ShadowDO

Continues on next page

1.322 TriggStopProc - Generate restart data for trigg signals at stop

RobotWare Base

Continued

- Count the number of value transitions (flanks) of the signal `ShadowDO`
- 4 Update the specified persistent variable with restart data.

Emergency stop (`QSTOP`)

The process `TriggStopProc` comprises the following steps:

- 1 Do the next step as soon as possible.
- 2 Store the current value (prevalue according to `restartdata`) of all used process signals. Set to zero all used process signals except `ShadowDO`.
- 3 Do the following during the next time slot, about 500 ms, if some process signal changes its value during this time:
 - Store its current value again (postvalue according to `restartdata`)
 - Set to zero that signal except `ShadowDO`
 - Count the number of value transitions (flanks) of the signal `ShadowDO`
- 4 Update the specified persistent variable with restart data.

Critical area for process restart

Both the robot servo and the external equipment have some lags. All the instructions in the `Trigg` family are designed so that all signals will be set at suitable places on the robot path, independently of different lags in external equipment, to obtain process results that are as good as possible. Because of this, the settings of I/O signals can be delayed between 0-80ms internally in the system after the robot stands still at program stop (`STOP`) or after registration of an emergency stop (`QSTOP`). Because of this disadvantage for the restart functionality, both the prevalue, postvalue, and the shadow flanks are introduced in restart data.

If this critical timeslot of 0-80ms coincides with the following application process cases then it is difficult to perform a good process restart:

- At the start of the application process
- At the end of the application process
- During a short application process
- During a short interrupt in the application process

Continues on next page

1 Instructions

1.322 TriggStopProc - Generate restart data for trigg signals at stop

RobotWare Base

Continued

The figure below illustrates process phases at STOP or QSTOP within critical time slot 0-80ms

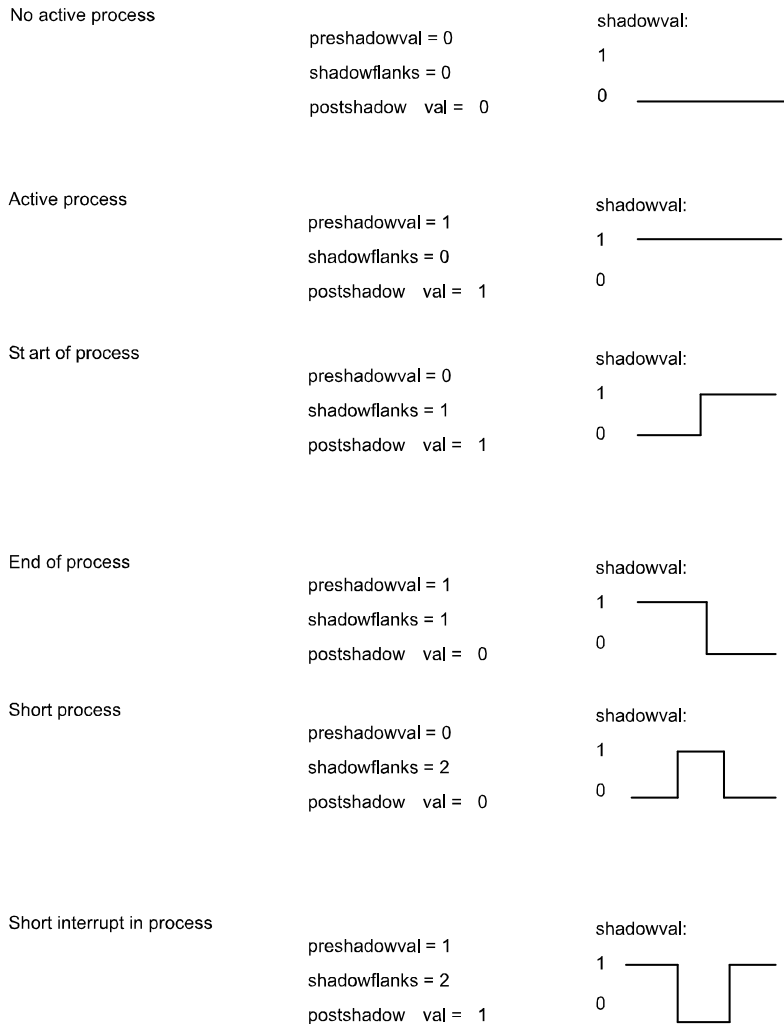

xx0500002326

Performing a restart

A restart of process instructions (NOSTEPIN routines) along the robot path must be done in a RESTART event routine.

The RESTART event routine can consist of the following steps:

	Action
1.	After QSTOP the regain to path is done at program start.
2.	Analyze the restart data from the latest STOP or QSTOP.

Continues on next page

	Action
3.	Determine the strategy for process restart from the result of the analysis such as: <ul style="list-style-type: none"> • Process active, do process restart • Process inactive, do not process restart • Do suitable actions depending on type of process application: <ul style="list-style-type: none"> - Start of process - End of process - Short process - Short interrupt in process
4.	Step backwards on the path.
5.	Continue the program results in movement restart.

If waiting in any STOP or QSTOP event routine until the TriggStopProc process is ready with e.g. `WaitUntil (myproc.restartstop=TRUE), \MaxTime:=2;`, the user must always reset the flag in the RESTART event routine with e.g. `myproc.restartstop:=FALSE`. After that the restart is ready.

Error handling

The following recoverable errors are generated and can be handled in an error handler. The system variable `ERRNO` will be set to:

Name	Cause of error
<code>ERR_NO_ALIASIO_DEF</code>	The signal variable is a variable declared in RAPID. It has not been connected to an I/O signal defined in the I/O configuration with instruction <code>AliasIO</code> .
<code>ERR_NORUNUNIT</code>	There is no contact with the I/O device.

Limitations

No support for restart of process instructions after a power failure.

TriggStopProc cannot be executed in an UNDO handler or RAPID routine connected to any of the following special system events: PowerOn, Stop, QStop, Restart, Reset or Step.

Syntax

```
TriggStopProc
[ RestartRef ::= ] < persistent (PERS) of restartdata>
[ '\ DO1 ::= ' < variable (VAR) of signaldo>
[ '\ GO1 ::= ' < variable (VAR) of signalgo> ]
[ '\ GO2 ::= ' < variable (VAR) of signalgo> ]
[ '\ GO3 ::= ' < variable (VAR) of signalgo> ]
[ '\ GO4 ::= ' < variable (VAR) of signalgo> ] ', '
[ ShadowDO ::= ] < variable (VAR) of signaldo> ';
```

Related information

For information about	See
Process instructions	TriggL - Linear robot movements with events on page 935 TriggC - Circular robot movement with events on page 891

Continues on next page

1 Instructions

1.322 TriggStopProc - Generate restart data for trigg signals at stop

RobotWare Base

Continued

For information about	See
Restart data	restartdata - Restart data for trigg signals on page 1725
Step backward on path	StepBwdPath - Move backwards one step on path on page 804
<i>Advanced RAPID</i>	<i>Application manual - Controller software IRC5</i>

1.323 TryInt - Test if data object is a valid integer

Usage

`TryInt` is used to test if a given data object is a valid integer.

Basic examples

The following examples illustrate the instruction `TryInt`:

Example 1

```
VAR num myint := 4;
...
TryInt myint;
```

The value of `myint` will be evaluated and since 4 is a valid integer, the program execution continues.

Example 2

```
VAR dnum mydnum := 20000000;
...
TryInt mydnum;
```

The value of `mydnum` will be evaluated and since 20000000 is a valid `dnum` integer, the program execution continues.

Example 3

```
VAR num myint := 5.2;
...
TryInt myint;
...
ERROR
  IF ERRNO = ERR_INT_NOTVAL THEN
    myint := Round(myint);
    RETRY;
  ENDIF
```

The value of `myint` will be evaluated and since 5.2 is not a valid integer, an error will be raised. In the error handler, `myint` will be rounded to 5 and the instruction `TryInt` is executed one more time.

Arguments

`TryInt DataObj | DataObj2`

`DataObj`

Data Object

Data type: num

The data object to test if it is a valid integer.

`DataObj2`

Data Object 2

Data type: dnum

The data object to test if it is a valid integer.

Continues on next page

1 Instructions

1.323 TryInt - Test if data object is a valid integer

RobotWare Base

Continued

Program execution

The given data object is tested:

- If it is a valid integer, the execution continues with the next instruction.
 - If it is not a valid integer, the execution continues in the error handler in an actual procedure.
-

Error handling

The following recoverable errors are generated and can be handled in an error handler. The system variable `ERRNO` will be set to:

Name	Cause of error
ERR_INT_NOTVAL	DataObj contains a decimal value.
ERR_INT_MAXVAL	<ul style="list-style-type: none">• The value of DataObj is larger or smaller than the integer value range of data type num.• The value of DataObj2 is larger or smaller than the integer value range of data type dnum.

Note that a value of 3.0 is evaluated as an integer, since .0 can be ignored.

Syntax

```
TryInt
  [ DataObj ':= ' ] < expression (IN) of num>
  | [ DataObj2 ':= ' ] < expression (IN) of dnum>' ;'
```

Related information

For information about	See
Data type num	num - Numeric values on page 1698

1.324 TRYNEXT - Jumps over an instruction which has caused an error

Usage

The TRYNEXT instruction is used to resume execution after an error, starting with the instruction following the instruction that caused the error.

Basic examples

The following example illustrates the instruction TryNext:

Example 1

```

reg2 := reg3/reg4;
...
ERROR
  IF ERRNO = ERR_DIVZERO THEN
    reg2:=0;
    TRYNEXT;
  ENDIF

```

An attempt is made to divide `reg3` by `reg4`. If `reg4` is equal to 0 (division by zero) then a jump is made to the error handler where `reg2` is assigned to 0. The TRYNEXT instruction is then used to continue with the next instruction.

Program execution

Program execution continues with the instruction subsequent to the instruction that caused the error.

Limitations

The instruction can only exist in a routine's error handler.

Syntax

```
TRYNEXT ' ; '
```

Related information

For information about	See
Error handlers	<i>Technical reference manual - RAPID Overview</i>

1 Instructions

1.325 TuneReset - Resetting servo tuning

RobotWare Base

1.325 TuneReset - Resetting servo tuning

Usage

`TuneReset` is used to reset the dynamic behavior of all robot axes and external mechanical units to their normal values.

This instruction can only be used in the main task `T_ROB1` or, if in a *MultiMove* system, in Motion tasks.

Basic examples

The following example illustrates the instruction `TuneReset`:

Example 1

```
TuneReset ;
```

Resetting tuning values for all axes to 100%.

Program execution

The tuning values for all axes are reset to 100%.

The default servo tuning values for all axes are automatically set by executing instruction `TuneReset`

- at a **Restart**.
- when a new program is loaded.
- when starting program execution from the beginning.

Syntax

```
TuneReset ' ; '
```

Related information

For information about	See
Tuning servos	TuneServo - Tuning servos on page 985

1.326 TuneServo - Tuning servos

Usage

TuneServo is used to tune the dynamic behavior of separate axes on the robot.

For most applications it is not necessary to use TuneServo, but for some applications, TuneServo is needed to obtain the desired accuracy. The use of TuneServo can in many cases be replaced by selecting a predefined *Motion Process Mode*, see *Technical reference manual - System parameters*, or by modifying a predefined *Motion Process Mode*.

For external axes TuneServo can be used for load adaptation.

Avoid doing TuneServo commands at the same time that the robot is moving. It can result in momentary high torque causing error indication and stops.

This instruction can only be used in the main task T_ROB1 or, if in a *MultiMove* system, in Motion tasks.



Note

To obtain optimal tuning it is essential that the correct load data is used. Check this before using TuneServo.



WARNING

Incorrect use of the TuneServo can cause oscillating movements or torques that can damage the robot. You must bear this in mind and be careful when using the TuneServo.

Description

Reduce overshoots and vibrations - TUNE_DF

TUNE_DF can be used for adjusting the predicted mechanical resonance frequency of a particular axis. A tune value of 95% reduces the resonance frequency by 5%. The most common use of TUNE_DF is to compensate for a foundation of inadequate stiffness, i.e. a flexible foundation. In this case, the tune value for axis 1 and 2 is lowered, typically to a value between 80% and 99%.

Use of TUNE_DF for axis 3 - 6 is rare and is normally not recommended. An exception is tuning of axis 4 - 6 for compensating the resonance frequency of an extended flexible payload.

Correctly adjusted, not too high and not too low, TUNE_DF reduces overshoots and vibrations. Be careful when adjusting TUNE_DF, since a too high or too low tune

Continues on next page

1 Instructions

1.326 TuneServo - Tuning servos

RobotWare Base

Continued

value can impair the movement considerably. One example of is shown in the figure below. In this case, a tune value of 100% gives the best result.

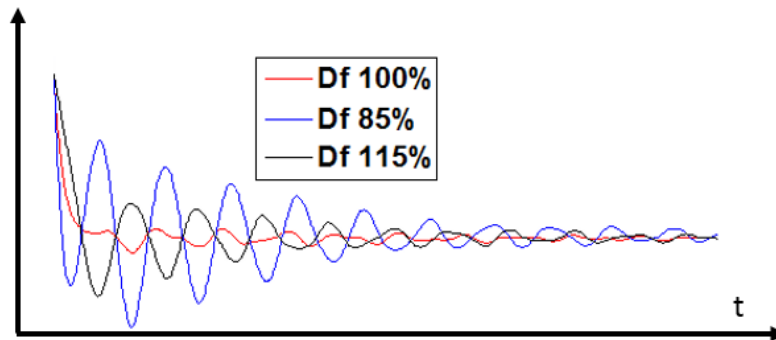

xx1400001280

The tune value can be automatically optimized by using TuneMaster, which is recommended.

For manual tuning, an example RAPID code snippet for tuning axis 1 is as follows:

```
MoveAbsJ [[0,0,0,0,0,0],[9E+09,9E+09,9E+09,9E+09,9E+09,9E+09]],  
v200, fine, myTool;  
FOR DF FROM 80 TO 100 STEP 5 DO  
  TuneServo ROB_1,1,DF\Type:=TUNE_DF;  
  MoveAbsJ [[2,0,0,0,0,0],[9E+09,9E+09,9E+09,9E+09,9E+09,9E+09]],  
vmax, fine, myTool;  
  WaitTime 1;  
  MoveAbsJ [[0,0,0,0,0,0],[9E+09,9E+09,9E+09,9E+09,9E+09,9E+09]],  
vmax, fine, myTool;  
  WaitTime 1;  
ENDFOR  
TuneReset;
```

Here, the tune value is changed in 5% steps, 2% steps could also be used. Note that the movement should be short, 2 degrees is a typical value. The robot should be positioned in a typical work area position. The tune value that minimizes overshoots and vibrations, by visual inspection, should be chosen.

Overshoots and vibrations can also be reduced by lowering the tune value for TUNE_DH or by reducing acceleration by using AccSet. In many cases, this is the best solution. However, if a problem can be solved by TUNE_DF, the cycle time is unaffected and the use of TUNE_DF is thus the best solution.

For robots where *Mounting Stiffness Factor* is available, see *Motion Process Mode* in *Technical reference manual - System parameters*, the use of *Mounting Stiffness Factor* for compensating a flexible foundation, replaces the use of TUNE_DF.

Reduce overshoots and vibrations - TUNE_DH

TUNE_DH can be used for increasing the smoothness of the robot path by adjusting the effective bandwidth of the system. The tune value can only be lowered and values above 100% will not affect the movements. A tune value less than 100% decreases the bandwidth and increases the smoothness, thereby reducing overshoots and vibrations.

Continues on next page

TUNE_DH only increases cycle time in fine points, whereas acceleration reductions increases cycle time all along the robot path. Therefore, using TUNE_DH can be a very cycle time efficient way to reduce vibrations and overshoots compared to lowering the acceleration by using the AccSet instruction. At high speed, larger corner zones than programmed will be noticeable when using TUNE_DH. Thus, use of TUNE_DH reduces path errors caused by vibrations but increases path errors at high speed by taking shortcuts in corner zones. The shortcuts will increase with decreased tune value and increased speed. If these shortcuts are not acceptable, AccSet is recommended instead of TUNE_DH.

The figure below shows the effect of a decreased tune value and that an undesired vibration can be removed with a proper tune value. For smaller tune values, the shortcut in the corner zone becomes noticeable.

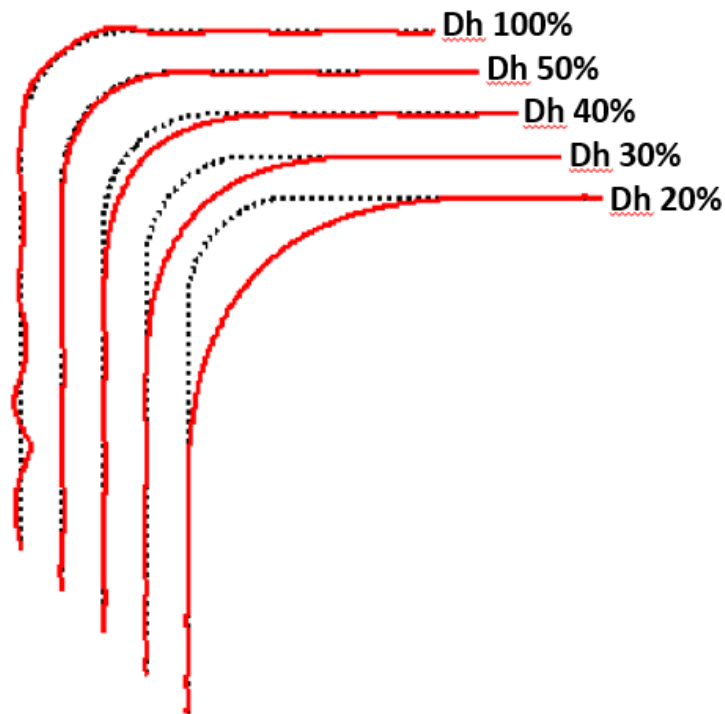

xx1400001281

It is sufficient to execute the instruction TuneServo with the argument \Type:=TUNE_DH for one axis. All axes in the same mechanical unit will automatically get the same tune value.

Examples:

- Cutting with TCP speeds up to 300 mm/s. A tune value of 50% reduces undesired vibrations.
This is sometimes combined with AccSet, e.g. AccSet 50,100;.
- Material handling at high speed. A tune value of 15% reduces undesired vibrations.

Continues on next page

1 Instructions

1.326 TuneServo - Tuning servos

RobotWare Base

Continued



CAUTION

Never change the tune value when the robot is moving and be careful when using small tune values (less than 30%) since the robot will take shortcuts in corner zones.

Only for ABB internal use - TUNE_DK, TUNE_DL, TUNE_DG, TUNE_DI



WARNING

Only for ABB internal use. Do not use these tune types. Incorrect use can cause oscillating movements or torques that can damage the robot.

Tuning external axes - TUNE_KP, TUNE_KV, TUNE_TI

These tune types affect position control gain (kp), speed control gain (kv), and speed control integration time (ti) for external axes. These are used for adapting external axes to different load inertias. Basic tuning of external axes can also be simplified by using these tune types.

Tuning robot axes - TUNE_KP, TUNE_KV, TUNE_TI

These parameters can be used for changing the behavior of the servo controller. TUNE_KP affects the equivalent gain of the position controller, TUNE_KV affects the equivalent gain of the speed controller, and TUNE_TI affects the integral action of the controller.

Increasing the tune value for TUNE_KV increases the servo stiffness of the robot and can be useful in contact applications since the total stiffness of the robot system depends on both the servo stiffness and the mechanical stiffness. An increased tune value for TUNE_KV also reduces the path errors at low speed and can be useful in cutting and welding applications where the speed is below 100 mm/s. Typical tune values are 150% - 200%. A tune value which is too high causes motor vibrations and must be avoided. Always be careful and be observant for increased motor noise level when adjusting TUNE_KV and do not use higher tune values than needed for fulfilling the application requirement. Too high tune value can also increase vibrations due to mechanical resonances.

An increased tune value for TUNE_KP and a decreased tune value for TUNE_TI increases the servo stiffness and reduces low speed path errors in the low frequency region. Typical tune values for TUNE_KP are 150% - 300%, and for TUNE_TI 20% - 50%. In most cases, TUNE_KV is the most important parameter and TUNE_KP and TUNE_TI do not need adjustment. Too high tune value for TUNE_KP or too low tune value for TUNE_TI can also increase vibrations due to mechanical resonances.

Example:

- Robot in deburring application need higher servo stiffness to reduce path errors. TUNE_KV 175%, TUNE_KP 250%, and TUNE_TI 30%.

This is often combined with AccSet, e.g. AccSet 30,100i.

Continues on next page

Friction compensation - TUNE_FRIC_LEV, TUNE_FRIC_RAMP

These tune types can be used to reduce robot path errors caused by friction and backlash at low speeds (10 - 200 mm/s). These path errors appear when a robot axis changes direction of movement. Activate friction compensation for an axis by setting the system parameter Motion/Control Parameters/Friction FFW On to Yes. The friction model is a constant level with opposite sign of the axis speed direction. *Friction FFW Level (Nm)* is the absolute friction level at (low) speeds and is greater than *Friction FFW Ramp (rad/s)*. See the figure below, which shows a friction model.

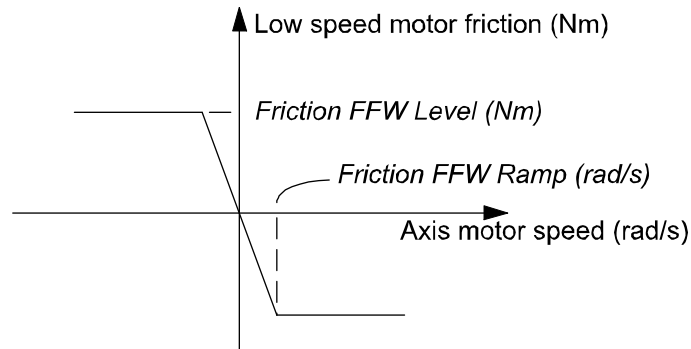

xx0500002188

TUNE_FRIC_LEV overrides the value of the system parameter *Friction FFW Level*. Tuning *Friction FFW Level* (using TUNE_FRIC_LEV) for each robot axis can improve the robot's path accuracy considerably in the speed range 20-100 mm/s. For larger robots, the effect will be minimal as other sources of tracking errors dominate these robots.

TUNE_FRIC_RAMP overrides the value of the system parameter *Friction FFW Ramp*. In most cases there is no need to tune the *Friction FFW Ramp*. The default setting will be appropriate.

Tune one axis at a time. Change the tuning value in small steps and find the level that minimizes the robot path error at positions on the path where this specific axis changes direction of movement. Repeat the same procedure for the next axis and so on.

The final tuning values can be transferred to the system parameters. Example:

- Friction FFW Level = 1. Final tune value (TUNE_FRIC_LEV) = 150%.
- Set Friction FFW Level = 1.5 and tune value = 100% (default value) which is equivalent.

Basic examples

The following example illustrates the instruction TuneServo:

Example 1

```
TuneServo MHA160R1, 1, 110 \Type:= TUNE_KP;
```

Activating of tuning type TUNE_KP with the tuning value 110% on axis 1 in the mechanical unit MHA160R1.

Arguments

```
TuneServo MecUnit Axis TuneValue [\Type]
```

Continues on next page

1 Instructions

1.326 TuneServo - Tuning servos

RobotWare Base

Continued

MecUnit

Mechanical Unit

Data type: mecunit

The name of the mechanical unit.

Axis

Data type: num

The number of the current axis for the mechanical unit (1 - 6).

TuneValue

Data type: num

Tuning value in percent (1 - 500). 100% is the normal value.

[\Type]

Data type: tunetype

Type of servo tuning. Available types are TUNE_DF, TUNE_KP, TUNE_KV, TUNE_TI, TUNE_FRIC_LEV, TUNE_FRIC_RAMP, TUNE_DG, TUNE_DH, TUNE_DI. **Type** TUNE_DK **and** TUNE_DL **only for ABB internal use.**

This argument can be omitted when using tuning type TUNE_DF.

Program execution

The specified tuning type and tuning value are activated for the specified axis. This value is applicable for all movements until a new value is programmed for the current axis, or until the tuning types and values for all axes are reset using the instruction TuneReset.

The default servo tuning values for all axes are automatically set by executing instruction TuneReset

- at a **Restart**.
- when a new program is loaded.
- when starting program execution from the beginning.

Limitations

Any active servo tuning are always set to default values at power fail.

This limitation can be handled in the user program at restart after power failure.

Syntax

```
TuneServo
  [MecUnit ':=' ] < variable (VAR) of mecunit> ', '
  [Axis ':=' ] < expression (IN) of num> ', '
  [TuneValue ':=' ] < expression (IN) of num>
  ['\ ' Type ':=' <expression (IN) of tunetype>] ';' ;'
```

Related information

For information about	See
Other motion settings	<i>Technical reference manual - RAPID Overview</i>

Continues on next page

For information about	See
Types of servo tuning	tunetype - Servo tune type on page 1799
Reset of all servo tunings	TuneReset - Resetting servo tuning on page 984
MotionProcessModeSet - Set motion process mode.	MotionProcessModeSet - Set motion process mode on page 390
Tuning of external axes	<i>Application manual - Additional axes and standalone controller</i>
Friction compensation	<i>Technical reference manual - System parameters</i>

1 Instructions

1.327 UIMsgBox - User Message Dialog Box type basic *RobotWare Base*

1.327 UIMsgBox - User Message Dialog Box type basic

Usage

UIMsgBox (*User Interaction Message Box*) is used to communicate with the user of the robot system on available user device, such as the FlexPendant. A message is written to the operator, who answers by selecting a button. The user selection is then transferred back to the program.

Basic examples

The following examples illustrate the instruction UIMsgBox:

See also [More examples on page 998](#).

Example 1

```
UIMsgBox "Continue the program ?";
```

The message "Continue the program ?" is displayed. The program proceeds when the user presses the default button OK.

Example 2

```
VAR btnres answer;  
...  
UIMsgBox  
  \Header:="UIMsgBox Header",  
  "Message Line 1"  
  \MsgLine2:="Message Line 2"  
  \MsgLine3:="Message Line 3"  
  \MsgLine4:="Message Line 4"  
  \MsgLine5:="Message Line 5"  
  \Buttons:=btnOKCancel  
  \Icon:=iconInfo  
  \Result:=answer;  
IF answer = resOK my_proc;
```

Continues on next page

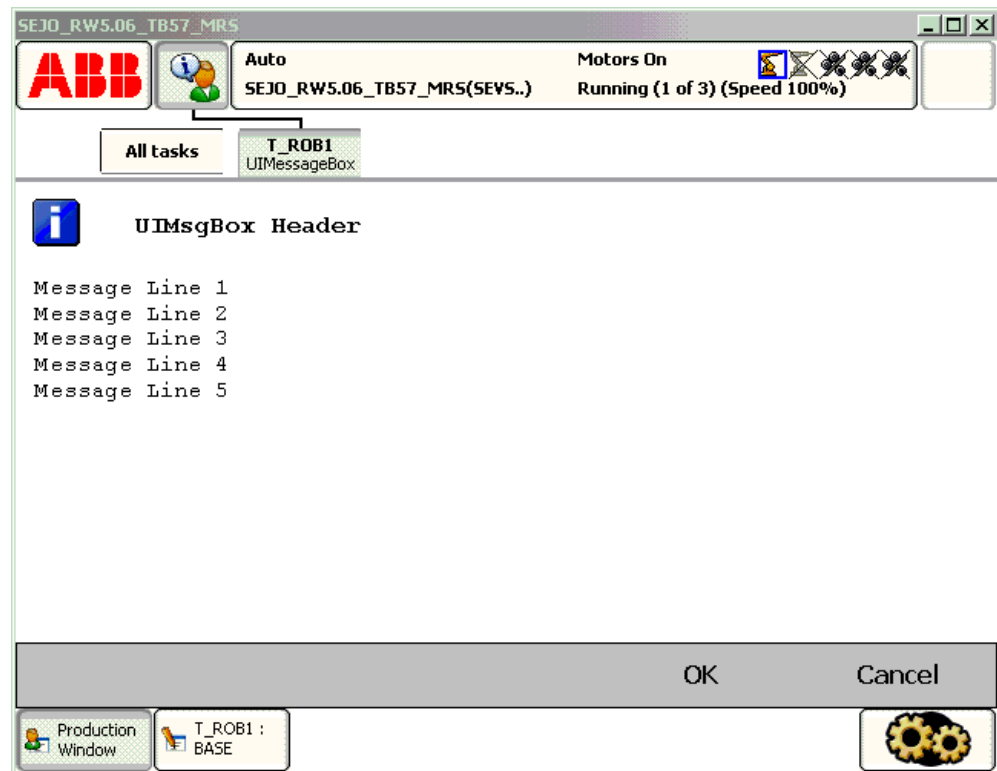

xx0500002432

Above message box with icon, header, message line 1 to 5, and push buttons is written on the FlexPendant display. Program execution waits until OK or Cancel is pressed. In other words, `answer` will be assigned 1 (OK) or 5 (Cancel) depending on which of the buttons is pressed. If answer is OK then `my_proc` will be called.

Note that Message Line 1 ... Message Line 5 are displayed on separate lines 1 to 5 (the switch `\Wrap` is not used).

Example 3

```
UIMsgBox \Header:= "Critical error", "Move the program pointer to
continue" \Buttons:=btnNone \Icon:=iconInfo;
```

This example will result in a dialog that will stay open until the operator moves the program pointer.

Arguments

```
UIMsgBox [\Header] MsgLine1 [MsgLine2] [MsgLine3] [MsgLine4] [MsgLine5]
[Wrap] [Buttons] [Icon] [Image] [Result] [MaxTime] [DIBreak] [DIPassive]
[DOBreak] [DOPassive] [\PersBoolBreak] [\PersBoolPassive] [\BreakFlag]
[UIActiveSignal]
```

[\Header]

Data type: `string`

Header text to be written at the top of the message box. Max. 40 characters.

MsgLine1

Message Line 1

Data type: `string`

Continues on next page

1 Instructions

1.327 UIMsgBox - User Message Dialog Box type basic

RobotWare Base

Continued

Text line 1 to be written on the display. Max. 55 characters.

[\MsgLine2]

Message Line 2

Data type: `string`

Additional text line 2 to be written on the display. Max. 55 characters.

[\MsgLine3]

Message Line 3

Data type: `string`

Additional text line 3 to be written on the display. Max. 55 characters.

[\MsgLine4]

Message Line 4

Data type: `string`

Additional text line 4 to be written on the display. Max. 55 characters.

[\MsgLine5]

Message Line 5

Data type: `string`

Additional text line 5 to be written on the display. Max. 55 characters.

[\Wrap]

Data type: `switch`

If selected, all the strings `MsgLine1 ... MsgLine5` will be concatenated to one string with a single space between each individual string and spread out on as few lines as possible.

Default, each message string `MsgLine1 ... MsgLine5` will be on separate lines on the display.

[\Buttons]

Data type: `buttondata`

Defines the push buttons to be displayed. Only one of the predefined buttons combination of type `buttondata` can be used. See [Predefined data on page 997](#).

Default, the system displays the OK button. (`\Buttons:=btnOK`).

[\Icon]

Data type: `icondata`

Defines the icon to be displayed. Only one of the predefined icons of type `icondata` can be used. See [Predefined data on page 997](#).

Default no icon.

[\Image]

Data type: `string`

The name of the image that should be used. To launch your own images, the images have to be placed in the `HOME :` directory in the active system or directly in the active system.

Continues on next page

The recommendation is to place the files in the `HOME:` directory so that they are saved if a Backup and Restore is done.

A Restart is required and then the FlexPendant will load the images.

The RobotWare option *FlexPendant Interface* is required.

The image can have the width of 185 pixels and the height of 300 pixels. If the image is bigger, only 185x300 pixels of the image are shown, starting at the top left of the image.

No exact value can be specified on the file size for an image or the number of images that can be loaded to the FlexPendant. It depends on the size of other files loaded to the FlexPendant. The program execution will continue if an image is used that has not been loaded to the FlexPendant.

[`\Result`]

Data type: `btnres`

The variable for which, depending on which button is pressed, the numeric value 0..7 is returned. Only one of the predefined constants of type `btnres` can be used to test the user selection. See [Predefined data on page 997](#).

If any type of system break such as `\MaxTime`, `\DIBreak`, or `\DOBreak` or if `\Buttons:=btnNone`, `resUnkwn` equal to 0 is returned.

[`\MaxTime`]

Data type: `num`

The maximum amount of time in seconds that program execution waits. If no button is selected within this time then the program continues to execute in the error handler unless the `BreakFlag` is used (see below). The constant `ERR_TP_MAXTIME` can be used to test whether or not the maximum time has elapsed.

[`\DIBreak`]

Digital Input Break

Data type: `signaldi`

The digital input signal that may interrupt the operator dialog. If no button is selected when the signal is set to 1 (or is already 1), the program continues to execute in the error handler, unless the `BreakFlag` is used (see below). The constant `ERR_TP_DIBREAK` can be used to test whether or not this has occurred.

[`\DIPassive`]

Digital Input Passive

Data type: `switch`

This switch overrides the default behavior when using `DIBreak` optional argument. Instead of reacting when signal is set to 1 (or already 1), the instruction should continue in the error handler (if no `BreakFlag` is used) when the signal `DIBreak` is set to 0 (or already is 0). The constant `ERR_TP_DIBREAK` can be used to test whether or not this has occurred.

[`\DOBreak`]

Digital Output Break

Continues on next page

1 Instructions

1.327 UIMsgBox - User Message Dialog Box type basic

RobotWare Base

Continued

Data type: `signaldo`

The digital output signal that may interrupt the operator dialog. If no button is selected when the signal is set to 1 (or is already 1) then the program continues to execute in the error handler unless the `BreakFlag` is used (see below). The constant `ERR_TP_DOBREAK` can be used to test whether or not this has occurred.

`[\DOPassive]`

Digital Output Passive

Data type: `switch`

This switch overrides the default behavior when using `DOBreak` optional argument. Instead of reacting when signal is set to 1 (or already 1), the instruction should continue in the error handler (if no `BreakFlag` is used) when the signal `DOBreak` is set to 0 (or already is 0). The constant `ERR_TP_DOBREAK` can be used to test whether or not this has occurred.

`[\PersBoolBreak]`

Persistent Boolean Break

Data type: `bool`

The persistent boolean that may interrupt the operator dialog. If no button is selected when the persistent boolean is set to `TRUE` (or is already `TRUE`) then the program continues to execute in the error handler unless the `BreakFlag` is used (see below). The constant `ERR_TP_PERSBOOLBREAK` can be used to test whether or not this has occurred.

`[\PersBoolPassive]`

Persistent Boolean Passive

Data type: `switch`

This switch overrides the default behavior when using `PersBoolBreak` optional argument. Instead of reacting when persistent boolean is set to `TRUE` (or already `TRUE`), the instruction should continue in the error handler (if no `BreakFlag` is used) when the persistent boolean `PersBoolBreak` is set to `FALSE` (or already is `FALSE`). The constant `ERR_TP_PERSBOOLBREAK` can be used to test whether or not this has occurred.

`[\BreakFlag]`

Data type: `errnum`

A variable that will hold the error code if `MaxTime`, `DIBreak`, `DOBreak`, or `PersBoolBreak` is used. If this optional variable is omitted then the error handler will be executed. The constants `ERR_TP_MAXTIME`, `ERR_TP_DIBREAK`, `ERR_TP_DOBREAK`, and `ERR_TP_PERSBOOLBREAK` can be used to select the reason.

`[\UIActiveSignal]`

Data type: `signaldo`

The digital output signal used in optional argument `UIActiveSignal` is set to 1 when the message box is activated on the FlexPendant. When the user selection has been done and the execution continue, the signal is set to 0 again.

Continues on next page

No supervision of stop or restart exist. The signal is set to 0 when the instruction is ready, or when PP is moved.

Program execution

The message box with icon, header, message lines, image, and buttons are displayed according to the programmed arguments. Program execution waits until the user selects one button or the message box is interrupted by time-out or signal action. The user selection and interrupt reason are transferred back to the program.

New message box on trap level takes the focus from the message box on the basic level.

Predefined data

icondata

The following constants of the data type `icondata` are predefined in the system:

Value	Constant	Icon
0	<code>iconNone</code>	No icon
1	<code>iconInfo</code>	Information icon
2	<code>iconWarning</code>	Warning icon
3	<code>iconError</code>	Error icon
4	<code>iconQuestion</code>	Question icon

buttondata

The following constants of the data type `buttondata` are predefined in the system.

Value	Constants	Button displayed
-1	<code>btnNone</code>	No button
0	<code>btnOK</code>	OK
1	<code>btnAbtrRtryIgn</code>	Abort, Retry and Ignore
2	<code>btnOKCancel</code>	OK and Cancel
3	<code>btnRetryCancel</code>	Retry and Cancel
4	<code>btnYesNo</code>	Yes and No
5	<code>btnYesNoCancel</code>	Yes, No and Cancel

It is possible to display user defined push buttons with the functions `UIMessageBox` and `UIListView`.

btnres

The following constants of the data type `btnres` are predefined in the system.

Value	Constants	Button answer
0	<code>resUnkwn</code>	Unknown result
1	<code>resOK</code>	OK
2	<code>resAbort</code>	Abort
3	<code>resRetry</code>	Retry

Continues on next page

1 Instructions

1.327 UIMsgBox - User Message Dialog Box type basic

RobotWare Base

Continued

Value	Constants	Button answer
4	resIgnore	Ignore
5	resCancel	Cancel
6	resYes	Yes
7	resNo	No

It is possible to work with user defined push buttons that answer with the functions `UIMessageBox` and `UIListView`.

Error handling

The following recoverable errors are generated and can be handled in an error handler. The system variable `ERRNO` will be set to:

Name	Cause of error
<code>ERR_NO_ALIASIO_DEF</code>	The signal variable is a variable declared in RAPID. It has not been connected to an I/O signal defined in the I/O configuration with instruction <code>AliasIO</code> .
<code>ERR_TP_NO_CLIENT</code>	There is no client, e.g. a FlexPendant, to take care of the instruction.
<code>ERR_UI_BUTTONS</code>	The argument <code>Buttons</code> of type <code>buttondata</code> has a not allowed value.
<code>ERR_UI_ICON</code>	The argument <code>Icon</code> of type <code>icondata</code> has a not allowed value.

If parameter `\BreakFlag` is not used then these situations can then be dealt with by the error handler:

- If there is a time-out (parameter `\MaxTime`) before an input from the operator then the system variable `ERRNO` is set to `ERR_TP_MAXTIME` and the execution continues in the error handler.
- If digital input is set (parameter `\DIBreak`) before an input from the operator then the system variable `ERRNO` is set to `ERR_TP_DIBREAK` and the execution continues in the error handler.
- If a digital output is set (parameter `\DOBreak`) before an input from the operator then the system variable `ERRNO` is set to `ERR_TP_DOBREAK` and the execution continues in the error handler.
- If a persistent boolean is set (parameter `\PersBoolBreak`) before an input from the operator then the system variable `ERRNO` is set to `ERR_TP_PERSBOOLBREAK` and the execution continues in the error handler.

More examples

More examples of how to use the instruction `UIMsgBox` are illustrated below.

Example 1

```
VAR errnum err_var;
...
UIMsgBox \Header:= "Example 1", "Waiting for a break condition..."
        \Buttons:=btnNone \Icon:=iconInfo \MaxTime:=60 \DIBreak:=di5
        \BreakFlag:=err_var;
```

Continues on next page

```

TEST err_var
CASE ERR_TP_MAXTIME:
    ! Time out break, max time 60 seconds has elapsed
CASE ERR_TP_DIBREAK:
    ! Input signal break, signal di5 has been set to 1
DEFAULT:
    ! Not such case defined
ENDTEST

```

The message box is displayed until a break condition has become true. The operator cannot answer or remove the message box because `btnNone` is set for the argument `\Buttons`. The message box is removed when `di5` is set to 1 or at time out (after 60 seconds).

Example 2

```

VAR errnum err_var;
...
UIMsgBox \Header:= "Example 2", "Waiting for a break condition..."
        \Buttons:=btnNone \Icon:=iconInfo \MaxTime:=60 \DIBreak:=di5
        \DIPassive \BreakFlag:=err_var;

TEST err_var
CASE ERR_TP_MAXTIME:
    ! Time out break, max time 60 seconds has elapsed
CASE ERR_TP_DIBREAK:
    ! Input signal break, signal di5 has been set to 0
DEFAULT:
    ! Not such case defined
ENDTEST

```

The message box is displayed until a break condition has become true. The operator can not answer or remove the message box because `btnNone` is set for the argument `\Buttons`. The message box is removed when `di5` is set to 0 or at time out (after 60 seconds).

Limitations

Avoid using too small values for the time-out parameter `\MaxTime` when `UIMsgBox` is frequently executed, like in a loop. It can result in an unpredictable behavior of the system performance, like slow response of the FlexPendant.

Syntax

```

UIMsgBox
    ['\Header':=' <expression (IN) of string>',']
    [MsgLine1:=''] <expression (IN) of string>
    ['\MsgLine2':='<expression (IN) of string>']
    ['\MsgLine3':='<expression (IN) of string>']
    ['\MsgLine4':='<expression (IN) of string>']
    ['\MsgLine5':='<expression (IN) of string>']
    ['\Wrap]
    ['\Buttons':=' <expression (IN) of buttondata>]
    ['\Icon':=' <expression (IN) of icondata>]

```

Continues on next page

1 Instructions

1.327 UIMsgBox - User Message Dialog Box type basic

RobotWare Base

Continued

```
['\'Image\' := <expression (IN) of string>]
['\'Result\' := < var or pers (INOUT) of btnres>]
['\'MaxTime\' := <expression (IN) of num>]
['\'DIBreak\' := <variable (VAR) of signaldi>]
['\'DIPassive]
['\'DOBreak\' := <variable (VAR) of signaldo>]
['\'DOPassive]
['\'PersBoolBreak \' := <persistent (PERS) of bool>]
['\'PersBoolPassive]
['\'BreakFlag\' := <var or pers (INOUT) of errnum>]
['\'UIActiveSignal \' := <variable (VAR) of signaldo>] ';'
```

Related information

For information about	See
Icon display data	icondata - Icon display data on page 1671
Push button data	buttondata - Push button data on page 1604
Push button result data	btnres - Push button result data on page 1601
User Interaction Message Box type advanced	UIMessageBox - User Message Box type advanced on page 1567
User Interaction Number Entry	UINumEntry - User Number Entry on page 1576
User Interaction Number Tune	UINumTune - User Number Tune on page 1583
User Interaction Alpha Entry	UIAlphaEntry - User Alpha Entry on page 1536
User Interaction List View	UIListView - User List View on page 1558
System connected to FlexPendant and so on.	UIClientExist - Exist User Client on page 1543
FlexPendant interface	Product specification - Controller IRC5
Clean up the Operator window	TPErase - Erases text printed on the FlexPendant on page 865

1.328 UIMsgWrite - User message dialog box type non-waiting

Usage

`UIMsgWrite` (*User Interaction Message Write*) is used to communicate with the user of the robot system on an available user device, such as the FlexPendant. A message is written to the operator.

Basic examples

The following examples illustrate the instruction `UIMsgWrite`.

Example 1

```
VAR string myHeader := "Signal error!";

UIMsgWrite myHeader, "Set signal di1 high please!" \Icon:=iconInfo;
WaitDI di1, 1;
UIMsgWriteAbort;
```

The message "*Set signal di1 high please!*" is displayed. The program proceeds and the message is removed when the signal `di1` is set.

Example 2

```
VAR string myHeader := "Signal Error!";
VAR string myMsgArray{5}:= ["Set", "signal", "di1", "high",
    "please!"];
UIMsgWrite myHeader, myMsgArray, \Icon:=iconInfo
    \Image:="MyImage.jpg";
WaitDI di1, 1;
UIMsgWriteAbort;
```

The message including header, five lines of message, icon, and image is displayed. The program proceeds and the message is removed when the signal `di1` is set. Note that message line 1 to message line 5 are displayed on separate lines 1 to 5 (the switch `\Wrap` is not used).

Arguments

```
UIMsgWrite Header Message | MsgArray [\Wrap] [\Icon] [\Image]
[\PersBool] | [\PersBoolName] [\AbortValue] [\UIActiveSignal]
```

Header

Data type: string

Header text to be written at the top of the message box. Maximum 40 characters.

Message

Data type: string

One text line to be written on the display. Maximum 50 characters.

MsgArray

(*Message Array*)

Data type: string

Continues on next page

1 Instructions

1.328 UIMsgWrite - User message dialog box type non-waiting

RobotWare Base

Continued

Several text lines from an array to be written on the display. Only one of the parameters `Message` or `MsgArray` can be used at the same time.

Maximum layout space is 5 lines with 50 characters each.

[`\Wrap`]

Data type: `switch`

If selected, all the lines in `MsgArray` will be concatenated to one string with a single space between each individual string and spread out on as few lines as possible.

Default, each line in `MsgArray` will be on separate lines on the display.

[`\Icon`]

Data type: `icondata`

Defines the icon to be displayed. Only one of the predefined icons of type `icondata` can be used, see [Predefined data on page 1003](#).

Default no icon.

[`\Image`]

Data type: `string`

The name of the image that should be used. To launch your own images, the images have to be placed in the `HOME:` directory in the active system or directly in the active system.

The recommendation is to place the files in the `HOME:` directory so that they are saved if a backup and restore is done.

A restart is required and then the FlexPendant will load the images.

A demand on the system is that the RobotWare option *FlexPendant Interface* is used.

The image that will be shown can have the width of 185 pixels and the height of 300 pixels. If the image is larger, then only 185 * 300 pixels of the image will be shown starting at the top left of the image.

No exact value can be specified on the size that an image can have or the amount of images that can be loaded to the FlexPendant. It depends on the size of other files loaded to the FlexPendant. The program execution will just continue if an image is used that has not been loaded to the FlexPendant.

[`\PersBool`]

(Persistent Bool)

Data type: `bool`

The message will be displayed as long as the specified `bool` is `FALSE`. If the parameter `AbortValue` is used, the message will be displayed as long as the specified `bool` differs in value from `AbortValue`.

Only an entire PERS bool or TASK PERS bool variable can be used.

[`\PersBoolName`]

(Persistent Bool Name)

Data type: `string`

Continues on next page

The message will be displayed as long as the specified `bool` is `FALSE`. If the parameter `AbortValue` is used, the message will be displayed as long as the specified `bool` differs in value from `AbortValue`.

Only an entire PERS `bool` or TASK PERS `bool` variable name can be used.

If using the `\PersBoolName` argument, it is possible to use a PERS `bool` variable declared in another task in the `UIMsgWrite` instruction.

`[\AbortValue]`

Data type: `bool`

Only valid if `PersBool` is present. The expected value for `PersBool`. The message will be displayed until `PersBool` equals `AbortValue`.

`[\UIActiveSignal]`

Data type: `signaldo`

The digital output signal used in optional argument `UIActiveSignal` is set to 1 when the message box is activated on the FlexPendant. The signal is set to 0 when the message box is removed with instruction `UIMsgWriteAbort` or when the `PersBool` expression is fulfilled.

No supervision of stop or restart exist. The signal is set to 0 when PP is moved.

Program execution

The message with icon, header, message lines, image, and unfulfilled expressions are displayed according to the programmed arguments. The message is displayed until the message is aborted by `UIMsgWriteAbort`, or the expression used in `PersBool` or `PersBoolName` arguments is fulfilled.

- A new message on basic level will replace an older message.
- A new message on trap level will replace an older message on basic level, and stay active when returning to basic level.
- A new message in a service routine will always be aborted when returning to basic level. Any active message on basic level will then be reactivated.
- A new user message generated by the following instructions and functions will replace a message generated by `UIMsgWrite`:

`TPReadFK`, `TPReadDnum`, `TPReadNum`, `UIMsgBox`, `UIMessageBox`, `UIDnumEntry`, `UIDnumTune`, `UINumEntry`, `UINumTune`, `UIAlphaEntry`, `UIListView`. A message box from one of the waiting instructions `WaitAI`, `WaitAO`, `WaitGI`, `WaitGO`, `WaitDI`, `WaitDO`, `WaitUntil` will also replace a message generated by `UIMsgWrite`.

Predefined data

The following constants of the data type `icondata` are predefined in the system:

Value	Constant	Icon
0	<code>iconNone</code>	No icon
1	<code>iconInfo</code>	Information icon
2	<code>iconWarning</code>	Warning icon

Continues on next page

1 Instructions

1.328 UIMsgWrite - User message dialog box type non-waiting

RobotWare Base

Continued

Value	Constant	Icon
3	iconError	Error icon
4	iconQuestion	Question icon

Error handling

The following recoverable errors are generated and can be handled in an error handler. The system variable `ERRNO` will be set to:

Name	Cause of error
ERR_NO_ALIASIO_DEF	The signal variable is a variable declared in RAPID. It has not been connected to an I/O signal defined in the I/O configuration with instruction <code>AliasIO</code> .
ERR_NORUNUNIT	There is no contact with the I/O device.
ERR_SIG_NOT_VALID	The I/O signal cannot be accessed. The reasons can be that the I/O device is not running or an error in the configuration (only valid for ICI field bus).
ERR_SYM_ACCESS	The data object used in [<code>\PersBoolName</code>] is non-existent.

Syntax

```
UIMsgWrite
  [Header ':='] <expression (IN) of string> ', '
  [Message ':='] <expression (IN) of string>
  | [MsgArray ':='] <array {*} (IN) of string>
  ['\ ' Wrap]
  ['\ ' Icon ':='] <expression (IN) of icondata>]
  ['\ ' Image ':='] <expression (IN) of string>]
  ['\ ' PersBool ':='] <pers (IN) of bool>]
  | ['\ ' PersBoolName ':='] <pers (IN) of string>]
  ['\ ' AbortValue ':='] <var or pers (IN) of bool>]
  ['\ ' UIActiveSignal ':='] <variable (VAR) of signaldo>] ';'

```

Related information

For information about	See
Icon display data	icondata - Icon display data on page 1671
Abort user message dialog	UIMsgWriteAbort - Abort user message dialog box type non-waiting on page 1005
System connected to FlexPendant and so on.	UIClientExist - Exist User Client on page 1543
FlexPendant interface	Product specification - Controller IRC5
Cyclic bool	Application manual - Controller software IRC5

1.329 UIMsgWriteAbort - Abort user message dialog box type non-waiting

Usage

`UIMsgWriteAbort` is used to abort an active message that has previously been launched by an `UIMsgWrite` instruction.

Basic examples

The following example illustrates the instruction `UIMsgWriteAbort`.

Example 1

```
VAR string myHeader := "Signal error!";

UIMsgWrite myHeader, "Set signal di1 high please!", iconInfo;
WaitDI di1, 1;
UIMsgWriteAbort;
```

The message "*Set signal di1 high please!*" is displayed. The program proceeds and the message is removed when the signal `di1` is set.

Syntax

```
UIMsgWriteAbort ';' ;'
```

Related information

For information about	See
Icon display data	icondata - Icon display data on page 1671
Write user message dialog	UIMsgWrite - User message dialog box type non-waiting on page 1001
System connected to FlexPendant and so on.	UIClientExist - Exist User Client on page 1543
FlexPendant interface	Product specification - Controller IRC5
Cyclic bool	Application manual - Controller software IRC5

1 Instructions

1.330 UIShow - User Interface show

RobotWare Base

1.330 UIShow - User Interface show

Usage

UIShow (*User Interface Show*) is used to communicate with the user of the robot system on the available User Device such as the FlexPendant. With UIShow both individually written applications and standard applications can be launched from a RAPID program.

Basic examples

The following examples illustrate the instruction UIShow:

Example 1 and example 2 only works if the files TpsViewMyAppl.dll and TpsViewMyAppl.gtpu.dll is present in the HOME: directory, and a Restart has been performed.

Example 1

```
CONST string Name:="TpsViewMyAppl.gtpu.dll";
CONST string Type:="ABB.Robotics.SDK.Views.TpsViewMyAppl";
CONST string Cmd1:="Init data string passed to the view";
CONST string Cmd2:="New init data string passed to the view";
PERS uishownum myinstance:=0;
VAR num mystatus:=0;
...
! Launch one view of my application MyAppl
UIShow Name, Type \InitCmd:=Cmd1 \InstanceID:=myinstance
      \Status:=mystatus;
! Update the view with new init command
UIShow Name, Type \InitCmd:=Cmd2 \InstanceID:=myinstance
      \Status:=mystatus;
```

The code above will launch the view TpsViewMyAppl with init command Cmd1, and then update the view with Cmd2.

Example 2

```
CONST string Name:="TpsViewMyAppl.gtpu.dll";
CONST string Type:="ABB.Robotics.SDK.Views.TpsViewMyAppl";
CONST string Cmd1:="Init data string passed to the view";
CONST string Cmd2:="New init data string passed to the view";
PERS uishownum myinstance:=0;
VAR num mystatus:=0;
...
! Launch one view of my application MyAppl
UIShow Name, Type \InitCmd:=Cmd1 \Status:=mystatus;
! Launch another view of the application MyAppl
UIShow Name, Type \InitCmd:=Cmd2 \InstanceID:=myinstance
      \Status:=mystatus;
```

The code above will launch the view TpsViewMyAppl with init command Cmd1. Then it launches another view with init command Cmd2.

Example 3

```
CONST string Name:="tpsviewbackupandrestore.dll";
CONST string Type:="ABB.Robotics.Tps.Views.TpsViewBackupAndRestore";
```

Continues on next page

```
VAR num mystatus:=0;
...
UIShow Name, Type \Status:=mystatus;
```

Launch standard application Backup and Restore.

Example 4

```
CONST string Name:="TpsViewPanel.gtpu.dll";
CONST string Type:="ABB.Robotics.SDK.Views.MainScreen";
PERS uishownum myinstance:=0;
VAR num mystatus:=0;
...
UIShow Name, Type \InstanceID:=myinstance \Status:=mystatus;
```

Launch an application created with ScreenMaker.

Arguments

```
UIShow AssemblyName TypeName [\InitCmd] [\InstanceId] [\Status]
[\NoCloseBtn]
```

AssemblyName

Data type: string

The name of the assembly that contains the view.

TypeName

Data type: string

This is the name of the view (the type to create). This is the fully qualified name of the type, i.e. its namespace is included.

[\InitCmd]

Init Command

Data type: string

A init data string passed to the view.

[\InstanceId]

Data type: uishownum

A parameter that represents a token used to identify a view. If a view is shown after the call to `UIShow` then a value that identifies the view is passed back. This token can then be used in other calls to `UIShow` to activate an already running view. If the value identifies an existing (running) view then the view will be activated. If it does not exist then a new instance will be created. This means that this parameter can be used to determine if a new instance will be launched or not. If its value identifies an already started view then this view will be activated regardless of the values of all other parameters. A recommendation is to use an unique `InstanceId` variable for each new application that is going to be launched with the `UIShow` instruction.

The parameter must be a persistent variable and the reason for this is that this variable should keep its value, even if the program pointer is moved to main. If executing the same `UIShow` as earlier and using the same variable then the same view will be activated if it is still open. If the view has been closed then a new view will be launched.

Continues on next page

1 Instructions

1.330 UIShow - User Interface show

RobotWare Base

Continued

`[\Status]`

Data type: num

`Status` indicates if the operation was successful or not. Note that if this option is used then the RAPID execution will be waiting until the instruction is completed, i.e. the view is launched.

This optional parameter is primary used for debugging purpose. (See *Error handling*)

Status	Description
0	OK
-1	No space left on the FlexPendant for the new view. Maximum 6 views can be open at the same time on the FlexPendant.
-2	Assembly could not be found, does not exist
-3	File was found, but could not be loaded
-4	Assembly exist, but no new instance could be created
-5	The typename is invalid for this assembly
-6	InstanceID does not match assembly to load

`[\NoCloseBtn]`

No Close Button

Data type: switch

`NoCloseBtn` disables the close button of the view.

Program execution

The `UIShow` instruction is used to launch individual applications on the FlexPendant. To launch individual applications, the assemblies have to be placed in the `HOME :` directory in the active system, or directly in the active system, or in an additional option. The recommendation is to place the files in the `HOME :` directory so that they are saved if a Backup and Restore is done. A Restart is required and then the FlexPendant loads the new assemblies.

A demand on the system is that the RobotWare option *FlexPendant Interface* is used.

It is also possible to launch standard applications such as Backup and Restore. Then there is no demand to have the RobotWare option *FlexPendant Interface*.

If using the argument `\Status` then the program execution will wait until the application is launched. If errors in the application are not handled then it is only the result of the launch that is supervised. Without the `\Status` parameter, the FlexPendant is ordered to launch the application but there is no check to determine if it is possible to launch it or not.

Error handling

The following recoverable errors are generated and can be handled in an error handler. The system variable `ERRNO` will be set to:

Name	Cause of error
<code>ERR_TP_NO_CLIENT</code>	There is no client, e.g. a FlexPendant, to take care of the instruction.

Continues on next page

If parameter `\Status` is used then these situations can then be dealt with by the error handler:

- If there is no space left on the FlexPendant for the assembly then the system variable `ERRNO` is set to `ERR_UISHOW_FULL` and the execution continues in the error handler. The FlexPendant can have 6 views open at the same time.
- If something else goes wrong when trying to launch a view then the system variable `ERRNO` is set to `ERR_UISHOW_FATAL`, and the execution continues in the error handler.

Limitations

When using `UIShow` instruction to launch individual applications then it is a demand that the system is equipped with the option *FlexPendant Interface*.

Applications that have been launched with the `UIShow` instruction do not survive power fail situations. `POWER ON` event routine can be used to setup the application again.

Syntax

```
UIShow
  [AssemblyName ':=' ] < expression (IN) of string > ','
  [TypeName ':=' ] < expression (IN) of string > ','
  [ '\InitCmd' :=' < expression (IN) of string > ]
  [ '\InstanceId :=' < persistent (PERS) of uishownum > ]
  [ '\Status :=' < variable (VAR) of num > ]
  [ '\NoCloseBtn ]';'
```

Related information

For information about	See
FlexPendant interface	<i>Product specification - Controller IRC5</i>
Building individual applications for the FlexPendant	http://developercenter.robotstudio.com/
uishownum	<i>uishownum - Instance ID for UIShow on page 1800</i>
Clean up the operator window	<i>TPERase - Erases text printed on the FlexPendant on page 865</i>

1 Instructions

1.331 UnLoad - Unload a program module during execution

RobotWare Base

1.331 UnLoad - Unload a program module during execution

Usage

UnLoad is used to unload a program module from the program memory during execution.

The program module must have previously been loaded into the program memory using the instructions `Load` or `StartLoad - WaitLoad`.

Basic examples

The following example illustrates the instruction `UnLoad`:

See also [More examples on page 1011](#) below.

Example 1

```
UnLoad diskhome \File:="PART_A.MOD";
```

UnLoad the program module `PART_A.MOD` from the program memory that was previously loaded into the program memory with `Load`. (See instruction `Load`). `diskhome` is a predefined string constant "HOME:".

Arguments

```
UnLoad [\ErrIfChanged] | [\Save] FilePath [\File]
```

`[\ErrIfChanged]`

Data type: `switch`

If this argument is used, and the module has been changed since it was loaded into the system, then the instruction will generate the error recovery code `ERR_NOTSAVED`.

`[\Save]`

Data type: `switch`

If this argument is used then the program module is saved before the unloading starts. The program module will be saved at the original place specified in the `Load` or `StartLoad` instruction.

`FilePath`

Data type: `string`

The file path and the file name to the file that will be unloaded from the program memory. The file path and the file name must be the same as in the previously executed `Load` or `StartLoad` instruction. The file name shall be excluded when the argument `\File` is used.

`[\File]`

Data type: `string`

When the file name is excluded in the argument `FilePath`, then it must be defined with this argument. The file name must be the same as in the previously executed `Load` or `StartLoad` instruction.

Continues on next page

Program execution

To be able to execute an `UnLoad` instruction in the program, a `Load` or `StartLoad` - `WaitLoad` instruction with the same file path and name must have been executed earlier in the program.

The program execution waits for the program module to finish unloading before the execution proceeds with the next instruction.

After that the program module is unloaded, and the rest of the program modules will be linked.

For more information see the instructions `Load` or `StartLoad-Waitload`.

**Note**

Be aware of that `Load`, `UnLoad`, and `WaitLoad` can affect both the motion execution and other RAPID execution and shall therefore be called with caution.

Error handling

The following recoverable errors are generated and can be handled in an error handler. The system variable `ERRNO` will be set to:

Name	Cause of error
<code>ERR_NOTSAVED</code>	The argument <code>\ErrIfChanged</code> is used and the module has been changed.
<code>ERR_UNLOAD</code>	The file in the <code>UnLoad</code> instruction cannot be unloaded because of ongoing execution within the module or wrong path (module not loaded with <code>Load</code> or <code>StartLoad</code>).

More examples

More examples of how to use the instruction `UnLoad` are illustrated below.

Example 1

```
UnLoad "HOME:/DOORDIR/DOOR1.MOD" ;
```

`UnLoad` the program module `DOOR1.MOD` from the program memory that was previously loaded into the program memory.

Example 2

```
UnLoad "HOME:" \File:="DOORDIR/DOOR1.MOD" ;
```

Same as in example 1 above but another syntax.

Example 3

```
Unload \Save, "HOME:" \File:="DOORDIR/DOOR1.MOD" ;
```

Same as in examples 1 and 2 above but saves the program module before unloading.

Limitations

It is not allowed to unload a program module that is executing (program pointer in the module).

Trap routines, system I/O events, and other program tasks cannot execute during the unloading.

Continues on next page

1 Instructions

1.331 UnLoad - Unload a program module during execution

RobotWare Base

Continued

Avoid ongoing robot movements during the unloading.

Program stop during execution of UnLoad instruction can result in guard stop with motors off and error message "20025 Stop order timeout" on the FlexPendant.

Syntax

```
UnLoad
  ['\ErrIfChanged ',''] | ['\Save ','']
  [FilePath:=']<expression (IN) of string>
  ['\File:=' <expression (IN) of string>'];'
```

Related information

For information about	See
Check program references	CheckProgRef - Check program references on page 130
Load a program module	Load - Load a program module during execution on page 342 StartLoad - Load a program module during execution on page 787 WaitLoad - Connect the loaded module to the task on page 1061

1.332 UnpackRawBytes - Unpack data from rawbytes data

Usage

`UnpackRawBytes` is used to unpack the contents of a container of type `rawbytes` to variables of type `byte`, `num`, `dnum` or `string`.

Basic examples

The following example illustrates the instruction `UnpackRawBytes`.

Example 1

```

VAR iODEV io_device;
VAR rawbytes raw_data_out;
VAR rawbytes raw_data_in;
VAR num integer;
VAR dnum bigInt;
VAR num float;
VAR string string1;
VAR byte byte1;
VAR byte data1;

! Data packed in raw_data_out according to the protocol
...
Open "chan1:", io_device\Bin;
WriteRawBytes io_device, raw_data_out;
ReadRawBytes io_device, raw_data_in\Time := 1;
Close io_device;

```

According to the protocol that is known to the programmer, the message is sent to device "chan1:". Then the answer is read from the device.

The answer contains, for an example, the following:

byte number:	contents:
1-4	integer 5
5-8	float 234.6
9-25	string "This is real fun!". This is a ISO 8859-1 (Latin-1) string, with single-byte characters.
26	hex value '4D'
27	ASCII code 122, that is, z
28-36	integer 4294967295
37-40	integer 4294967295

```

UnpackRawBytes raw_data_in, 1, integer \IntX := DINT;

```

The contents of `integer` will be 5.

```

UnpackRawBytes raw_data_in, 5, float \Float4;

```

The contents of `float` will be 234.6 decimal.

```

UnpackRawBytes raw_data_in, 9, string1 \ASCII:=17;

```

The contents of `string1` will be "This is real fun!".

```

UnpackRawBytes raw_data_in, 26, byte1 \Hex1;

```

Continues on next page

1 Instructions

1.332 UnpackRawBytes - Unpack data from rawbytes data

RobotWare Base

Continued

The contents of `byte1` will be '4D' hexadecimal.

```
UnpackRawBytes raw_data_in, 27, data1 \ASCII:=1;
```

The contents of `data1` will be 122, the ASCII code for "z".

```
UnpackRawBytes raw_data_in, 28, bigInt \IntX := LINT;
```

The contents of `bigInt` will be 4294967295.

```
UnpackRawBytes raw_data_in, 37, bigInt \IntX := UDINT;
```

The contents of `bigInt` will be 4294967295.

Arguments

```
UnpackRawBytes RawData [ \Network ] StartIndex Value [ \Hex1 ] | [ \IntX ] | [ \Float4 ] | [ \ASCII ]
```

See [Combining the arguments on page 1015](#).

RawData

Data type: rawbytes

Variable container to unpack data from.

[\Network]

Data type: switch

Indicates that integer and float shall be unpacked from big-endian (network order) represented in `RawData`. ProfiBus and InterBus use big-endian.

Without this switch, integer and float will be unpacked in little-endian (not network order) representation from `RawData`. DeviceNet uses little-endian.

Only relevant together with optional parameter `\IntX` - UINT, UDINT, , ULINT, INT, DINT, LINT, and `\Float4`.

StartIndex

Data type: num

`StartIndex`, between 1 and 1024, indicates where to start unpacking data from `RawData`.

Value

Data type: anytype

Variable containing the data that was unpacked from `RawData`.

Allowed data types are: byte, num, dnum or string. Array cannot be used.

[\Hex1]

Data type: switch

The data to be unpacked and placed in `Value` has hexadecimal format in 1 byte and will be converted to decimal format in a byte variable.

[\IntX]

Data type: inttypes

The data to be unpacked has the format according to the specified constant of data type `inttypes`. The data will be converted to a num or a dnum variable containing an integer and stored in `Value`.

See [Predefined data on page 1015](#).

Continues on next page

[\Float4]

Data type: switch

The data to be unpacked and placed in Value has float, 4 bytes, format, and it will be converted to a num variable containing a float.

[\ASCII]

Data type: num

The data to be unpacked and placed in Value has byte or string format.

If Value is of type byte then the data will be interpreted as ASCII code and converted to byte format (1 character).

If Value is of type string then the data will be stored as string (1...80 characters). String data is not NULL terminated in data of type rawbytes.

Combining the arguments

One of the arguments \Hex1, \IntX, \Float4, or \ASCII must be used.

The following combinations are allowed:

Data type of value:	Allowed optional parameters:
num ⁱ	\IntX
dnum ⁱⁱ	\IntX
num	\Float4
string	\ASCII (1-80 characters)
byte	\Hex1 \ASCII

ⁱ Must be an integer within the value range of selected symbolic constant USINT, UINT, UDINT, SINT, INT or DINT.

ⁱⁱ Must be an integer within the value range of selected symbolic constant USINT, UINT, UDINT, ULINT, SINT, INT, DINT or LINT.

Program execution

During program execution data is unpacked from the container of type rawbytes into a variable of type anytype.

At power fail restart, any open file or I/O device in the system will be closed and the I/O descriptor in the variable of type iODEV will be reset.

Predefined data

The following symbolic constants of the data type inttypes are predefined and can be used to specify the integer in parameter \IntX.

Symbolic constant	Constant value	Integer format	Integer value range
USINT	1	Unsigned 1 byte integer	0 ... 255
UINT	2	Unsigned 2 byte integer	0 ... 65 535
UDINT	4	Unsigned 4 byte integer	0 ... 8 388 608 ⁱ 0 ... 4 294 967 295 ⁱⁱ
ULINT	8	Unsigned 8 byte integer	0 ... 4 503 599 627 370 496 ⁱⁱⁱ
SINT	- 1	Signed 1 byte integer	- 128... 127

Continues on next page

1 Instructions

1.332 UnpackRawBytes - Unpack data from rawbytes data

RobotWare Base

Continued

Symbolic constant	Constant value	Integer format	Integer value range
INT	- 2	Signed 2 byte integer	- 32 768 ... 32 767
DINT	- 4	Signed 4 byte integer	- 8 388 607 ... 8 388 608 ⁱ -2 147 483 648 ... 2 147 483 647 ^{iv}
LINT	- 8	Signed 8 byte integer	- 4 503 599 627 370 496... 4 503 599 627 370 496 ⁱⁱⁱ

- ⁱ Limitation in RAPID for storage of integer in data type `num`.
- ⁱⁱ Range when using a `dnum` variable and inttype `UDINT`.
- ⁱⁱⁱ Limitation in RAPID for storage of integer in data type `dnum`.
- ^{iv} Range when using a `dnum` variable and inttype `DINT`.

Syntax

```
UnpackRawBytes
  [RawData ':=' ] <variable (VAR) of rawbytes>
  ['\ ' Network] ', '
  [StartIndex ':=' ] <expression (IN) of num> ', '
  [Value ':=' ] <variable (VAR) of anytype>
  ['\ ' Hex1 ]
  [['\ ' IntX' :=' <expression (IN) of inttypes> ]
  [['\ ' Float4 ]
  [['\ ' ASCII' :=' <expression (IN) of num> ]';'
```

Related information

For information about	See
rawbytes data	rawbytes - Raw data on page 1721
Get the length of rawbytes data	RawBytesLen - Get the length of rawbytes data on page 1422
Clear the contents of rawbytes data	ClearRawBytes - Clear the contents of rawbytes data on page 145
Copy the contents of rawbytes data	CopyRawBytes - Copy the contents of rawbytes data on page 169
Pack DeviceNet header into rawbytes data	PackDNHeader - Pack DeviceNet Header into rawbytes data on page 505
Pack data into rawbytes data	PackRawBytes - Pack data into rawbytes data on page 508
Write rawbytes data	WriteRawBytes - Write rawbytes data on page 1108
Read rawbytes data	ReadRawBytes - Read rawbytes data on page 593
Bit/Byte Functions	Technical reference manual - RAPID Overview
String functions	Technical reference manual - RAPID Overview
File and I/O device handling	Application manual - Controller software IRC5

1.333 VelSet - Changes the programmed velocity

Usage

`VelSet` is used to increase or decrease the programmed velocity of all subsequent movement instructions. This instruction is also used to limit the maximum TCP velocity.

This instruction can only be used in the main task `T_ROB1` or, if in a *MultiMove* system, in Motion tasks.

Basic examples

The following example illustrates the instruction `VelSet`:

See also [More examples on page 1018](#).

Example 1

```
VelSet 50, 800;
```

All the programmed velocities are decreased to 50% of the value in the instruction. The TCP velocity is not permitted to exceed 800 mm/s.

Arguments

```
VelSet Override Max
```

Override

Data type: num

Desired velocity as a percentage of programmed velocity. 100% corresponds to the programmed velocity.

Max

Data type: num

Maximum TCP velocity in mm/s.

Program execution

The programmed velocity applies for the next executed movement instruction until a new `VelSet` instruction is executed.

The argument `Override` affects:

- All velocity components (TCP, orientation, rotating, and linear external axes) in `speeddata`.
- The programmed velocity override in the positioning instruction (the argument `\v`).
- Timed movements.

The argument `Override` does not affect:

- The welding speed in `welldata`.
- The heating and filling speed in `seamdata`.

The argument `Max` only limits the velocity of the TCP if it is lower than the programmed velocity.

Continues on next page

1 Instructions

1.333 VelSet - Changes the programmed velocity

RobotWare Base

Continued

The default values for `Override` and `Max` are 100% and `vmax.v_tcp` mm/s respectively. These values are automatically set

- when using the restart mode **Reset RAPID**
- when loading a new program or a new module
- when starting program execution from the beginning
- when moving the program pointer to `main`
- when moving the program pointer to a routine
- when moving the program pointer in such a way that the execution order is lost.



Note

The maximum TCP speed for the used robot type can be changed in the *Motion* configuration system parameters, type *Motion Planner* and attribute *Linear Max Speed*. The RAPID function `MaxRobSpeed` returns the same value.

More examples

More examples of how to use the instruction `VelSet` are illustrated below.

Example 1

```
VelSet 50, 800;
MoveL p1, v1000, z10, tool1;
MoveL p2, v2000, z10, tool1;
MoveL p3, v1000\T:=5, z10, tool1;
```

The speed is 500 mm/s to point `p1` and 800 mm/s to `p2`. It takes 10 seconds to move from `p2` to `p3`.

Limitations

The maximum speed is not taken into consideration when the time is specified in the movement instruction.

Syntax

```
VelSet
  [ Override ':=' ] < expression (IN) of num > ', '
  [ Max ':=' ] < expression (IN) of num > ';' ;
```

Related information

For information about	See
Reduction of acceleration	AccSet - Reduces the acceleration on page 25
Max. TCP speed for this robot	MaxRobSpeed - Maximum robot speed on page 1363
Motion settings data	motsetdata - Motion settings data on page 1692
Definition of velocity	speeddata - Speed data on page 1751
Positioning instructions	Technical reference manual - RAPID Overview

1.334 WaitAI - Waits until an analog input signal value is set

Usage

WaitAI (*Wait Analog Input*) is used to wait until an analog input signal value is set.

Basic examples

The following examples illustrate the instruction WaitAI:

Example 1

```
WaitAI a11, \GT, 5;
```

Program execution only continues after the a11 analog input has value greater than 5.

Example 2

```
WaitAI a11, \LT, 5;
```

Program execution only continues after the a11 analog input has value less than 5.

Arguments

```
WaitAI Signal [\LT] | [\GT] Value [\MaxTime] [\ValueAtTimeout]
[\Visualize] [\Header] [\Message] | [\MsgArray] [\Wrap]
[\Icon] [\Image] [\VisualizeTime] [\UIActiveSignal]
[\ErrorNumber] [\TimeOutSignal] [\TimeOutGOSignal]
[\TimeOutGOValue]
```

Signal

Data type: signalai

The name of the analog input signal.

[\LT]

Less Than

Data type: switch

If using this parameter, the WaitAI instruction waits until the analog signal value is less than the value in Value.

[\GT]

Greater Than

Data type: switch

If using this parameter the WaitAI instruction waits until the analog signal value is greater than the value in Value.

Value

Data type: num

The desired value of the signal.

[\MaxTime]

Maximum Time

Data type: num

Continues on next page

1 Instructions

1.334 WaitAI - Waits until an analog input signal value is set

RobotWare Base

Continued

The maximum period of waiting time permitted, expressed in seconds. If this time runs out before the condition is met, the error handler will be called, if there is one, with the error code `ERR_WAIT_MAXTIME`. If there is no error handler, the execution will be stopped.

`[\ValueAtTimeout]`

Data type: `num`

If the instruction time-out, the current signal value will be stored in this variable. The variable will only be set if the system variable `ERRNO` is set to `ERR_WAIT_MAXTIME`.

`[\Visualize]`

Data type: `switch`

If selected, the visualization is activated. The visualization consists of a message box with the condition that is not fulfilled, icon, header, message lines, and image is displayed according to the programmed arguments.

`[\Header]`

Data type: `string`

Header text to be written at the top of the message box. Maximum 40 characters. If no `\Header` argument is used a default message will be displayed.

`[\Message]`

Data type: `string`

One text line to be written on the display. Maximum 50 characters.

`[\MsgArray]`

(Message Array)

Data type: `string`

Several text lines from an array to be written on the display. Only one of the parameters `\Message` or `\MsgArray` can be used at the same time.

Maximum layout space is 5 lines with 50 characters each.

`[\Wrap]`

Data type: `switch`

If selected, all the specified strings in the argument `\MsgArray` will be concatenated to one string with a single space between each individual string and spread out on as few lines as possible.

Default, each string in the argument `\MsgArray` will be on separate lines on the display.

`[\Icon]`

Data type: `icondata`

Defines the icon to be displayed. Only one of the predefined icons of type `icondata` can be used. See [Predefined data on page 1671](#).

Default, no icon.

Continues on next page

[\Image]

Data type: string

The name of the image that should be used. To launch your own images, the images have to be placed in the *HOME:* directory in the active system or directly in the active system.

The recommendation is to place the files in the *HOME:* directory so that they are saved if a backup and restore is done.

A restart is required and then the FlexPendant will load the images.

A demand on the system is that the RobotWare option *FlexPendant Interface* is used.

The image that will be shown can have the width of 185 pixels and the height of 300 pixels. If the image is larger, then only 185 * 300 pixels of the image will be shown starting at the top left of the image.

No exact value can be specified on the size that an image can have or the amount of images that can be loaded to the FlexPendant. It depends on the size of other files loaded to the FlexPendant. The program execution will just continue if an image is used that has not been loaded to the FlexPendant.

[\VisualizeTime]

Data type: num

The waiting time before the message box should appear on the FlexPendant. If using the arguments `\VisualizeTime` and `\MaxTime`, the time used in argument `\MaxTime` needs to be bigger than the time used in argument `\VisualizeTime`.

The default time for the visualization if not using the argument `\VisualizeTime` is 5 s. Minimum value 1 s. Maximum value no limit. Resolution 0.001 s.

[\UIActiveSignal]

Data type: signaldo

The digital output signal used in optional argument `UIActiveSignal` is set to 1 when the visualization message box is activated on the FlexPendant. When the message box is removed (when the condition is met), the signal is set to 0 again.

No supervision of stop or restart exist. The signal is set to 0 when the instruction is ready, or when PP is moved.

[\ErrorNumber]

Error number

Data type: errnum

A variable (before used it is set to 0 by the system) that will hold the error constant if the instruction ends before the signal has the desired value.

If this optional variable is omitted then the error handler will be executed. The constants `ERR_GO_LIM`, `ERR_NO_ALIASIO_DEF`, `ERR_NORUNUNIT`, `ERR_SIG_NOT_VALID`, and `ERR_WAIT_MAXTIME` can be used to select the reason.

[\TimeOutSignal]

Data type: signaldo

Continues on next page

1 Instructions

1.334 WaitAI - Waits until an analog input signal value is set

RobotWare Base

Continued

If `TimeOutSignal` is used, the signal is set to 0 when entering the `Wait` instruction. It is set to 1 if the instruction times out after waiting. The signal is also set to 0 when the program pointer is moved out from the `Wait` instruction.

This argument can only be used if the argument `MaxTime` is used.

[`\TimeOutGOSignal`]

Data type: `signalgo`

If `TimeOutGOSignal` is used, the signal is set to 0 when entering the `Wait` instruction. It is set to the value used in the argument `TimeOutGOValue` if the instruction times out after waiting. The signal is also set to 0 when the program pointer is moved out from the `Wait` instruction.

The optional arguments `TimeOutGOSignal` and `TimeOutGOValue` must be used together.

This argument can only be used if the argument `MaxTime` is used.

[`\TimeOutGOValue`]

Data type: `dnum`

The argument `TimeOutGOValue` holds the value that the signal in argument `TimeOutGOSignal` will be set to, if the instruction times out after waiting.

The optional arguments `TimeOutGOSignal` and `TimeOutGOValue` must be used together.

This argument can only be used if the argument `MaxTime` is used.

Program execution

If the value of the signal is correct when the instruction is executed, the program simply continues with the following instruction.

If the signal value is incorrect, the robot enters a waiting state and the program continues when the signal changes to the correct value. The change is detected with an interrupt, which gives a fast response (not polled).

When the robot is waiting, the time is supervised. By default, the robot can wait forever, but the maximal waiting time can be specified with the optional argument `\MaxTime`. If this maximum time is exceeded, an error is raised.

If program execution is stopped, and later restarted, the instruction evaluates the current value of the signal. Any change during program stop is rejected.

In manual mode, after waiting more than 3 s, an alert box will pop up asking if the instruction should be simulated. It is possible to configure the alert to not appear, by setting the system parameter `SimulateMenu` to `NO`, see *Technical reference manual - System parameters*, topic *Controller*, type *General RAPID*.

If the switch `\Visualize` is used, a message box is displayed on the FlexPendant according to the programmed arguments. If no `\Header` argument is used a default header text will be displayed. When the execution of the `WaitAI` instruction is ready, the message box will be removed from the FlexPendant.

New message box on trap level takes the focus from the message box on the basic level.

Continues on next page

Error handling

The following recoverable errors are generated and can be handled in an error handler. The system variable `ERRNO` will be set to:

Name	Cause of error
<code>ERR_AO_LIM</code>	The programmed <code>Value</code> argument for the specified analog input signal <code>Signal</code> is outside limits.
<code>ERR_GO_LIM</code>	The programmed <code>TimeOutGOValue</code> argument for the specified digital group output signal <code>TimeOutGOSignal</code> is out of limit.
<code>ERR_NO_ALIASIO_DEF</code>	The signal variable is a variable declared in RAPID. It has not been connected to an I/O signal defined in the I/O configuration with instruction <code>AliasIO</code> .
<code>ERR_NORUNUNIT</code>	There is no contact with the I/O device.
<code>ERR_SIG_NOT_VALID</code>	The I/O signal cannot be accessed. The reasons can be that the I/O device is not running or an error in the configuration (only valid for ICI field bus).
<code>ERR_WAIT_MAXTIME</code>	There is a time-out (parameter <code>\MaxTime</code>) before the signal changes to the right value.

More examples

More examples of the instruction `WaitAI` are illustrated below.

Example 1

```
VAR num myvalattimeout:=0;
WaitAI ail, \LT, 5 \MaxTime:=4 \ValueAtTimeout:=myvalattimeout;
ERROR
  IF ERRNO=ERR_WAIT_MAXTIME THEN
    TPWrite "Value of ail at timeout:" + ValToStr(myvalattimeout);
    TRYNEXT;
  ELSE
    ! No error recovery handling
  ENDIF
```

Program execution continues only if `ail` is less than 5, or when timing out. If timing out, the value of the signal `ail` at timeout can be logged without another read of signal.

Example 2

```
WaitAI ail \GT, 5 \Visualize \Header:="Waiting for signal"
  \MsgArray:=["Movement will not start until", "the condition
  below is TRUE"] \Icon:=iconError;
MoveL p40, v500, z20, L10tip;
..
```

Continues on next page

1 Instructions

1.334 WaitAI - Waits until an analog input signal value is set

RobotWare Base

Continued

If the condition is not met then the header and message specified in the optional arguments `\Header` and `\MsgArray` will be written on the display of the FlexPendant together with the condition that is not met.

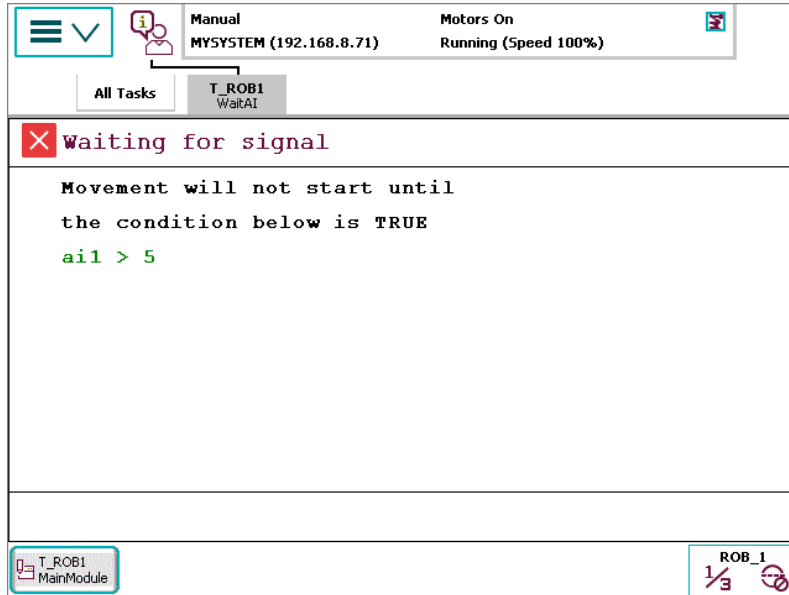

xx1600000150

Syntax

```
WaitAI
[ Signal ':= ' ] <variable (VAR) of signalai> ', '
[ '\ LT ] | [ '\ GT ] ', '
[ Value ':= ' ] <expression (IN) of num>
[ '\ MaxTime ' := <expression (IN) of num> ]
[ '\ ValueAtTimeout ' := <variable (VAR) of num> ]
[ '\ Visualize ]
[ '\ Header ' := <expression (IN) of string> ]
[ '\ Message ' := <expression (IN) of string> ]
| [ '\ MsgArray ' := <array {*} (IN) of string> ]
[ '\ Wrap ]
[ '\ Icon ' := <expression (IN) of icondata> ]
[ '\ Image ' := <expression (IN) of string> ]
[ '\ VisualizeTime ' := <expression (IN) of num> ]
[ '\ UIActiveSignal ' := <variable (VAR) of signaldo> ]
[ '\ ErrorNumber ' := <variable or persistent (INOUT) of errnum> ]
[ '\ TimeOutSignal ' := <variable (VAR) of signaldo> ]
[ '\ TimeOutGOSignal ' := <variable (VAR) of signalgo> ]
[ '\ TimeOutGOValue ' := <expression (IN) of dnum> ]';'
```

Related information

For information about	See
Waiting until a condition is satisfied	WaitUntil - Waits until a condition is met on page 1079

Continues on next page

1.334 WaitAI - Waits until an analog input signal value is set

RobotWare Base

Continued

For information about	See
Waiting for a specified period of time	WaitTime - <i>Waits a given amount of time on page 1077</i>
Waiting until an analog output is set/reset	WaitAO - <i>Waits until an analog output signal value is set on page 1026</i>

1 Instructions

1.335 WaitAO - Waits until an analog output signal value is set
RobotWare Base

1.335 WaitAO - Waits until an analog output signal value is set

Usage

WaitAO (*Wait Analog Output*) is used to wait until an analog output signal value is set.

Basic examples

The following examples illustrate the instruction WaitAO:

Example 1

```
WaitAO ao1, \GT, 5;
```

Program execution only continues after the ao1 analog output has value greater than 5.

Example 2

```
WaitAO ao1, \LT, 5;
```

Program execution only continues after the ao1 analog output has value less than 5.

Arguments

```
WaitAO Signal [\LT] | [\GT] Value [\MaxTime] [\ValueAtTimeout]  
[\Visualize] [\Header] [\Message] | [\MsgArray] [\Wrap]  
[\Icon] [\Image] [\VisualizeTime] [\UIActiveSignal]  
[\ErrorNumber] [\TimeOutSignal] [\TimeOutGOSignal]  
[\TimeOutGOValue]
```

Signal

Data type: signalao

The name of the analog output signal.

[\LT]

Less Than

Data type: switch

If using this parameter, the WaitAO instruction waits until the analog signal value is less than the value in Value.

[\GT]

Greater Than

Data type: switch

If using this parameter, the WaitAO instruction waits until the analog signal value is greater than the value in Value.

Value

Data type: num

The desired value of the signal.

[\MaxTime]

Maximum Time

Data type: num

Continues on next page

The maximum period of waiting time permitted, expressed in seconds. If this time runs out before the condition is met, the error handler will be called, if there is one, with the error code `ERR_WAIT_MAXTIME`. If there is no error handler, the execution will be stopped.

`[\ValueAtTimeout]`

Data type: `num`

If the instruction time-out, the current signal value will be stored in this variable. The variable will only be set if the system variable `ERRNO` is set to `ERR_WAIT_MAXTIME`.

`[\Visualize]`

Data type: `switch`

If selected, the visualization is activated. The visualization consists of a message box with the condition that is not fulfilled, icon, header, message lines, and image is displayed according to the programmed arguments.

`[\Header]`

Data type: `string`

Header text to be written at the top of the message box. Maximum 40 characters. If no `\Header` argument is used a default message will be displayed.

`[\Message]`

Data type: `string`

One text line to be written on the display. Maximum 50 characters.

`[\MsgArray]`

(Message Array)

Data type: `string`

Several text lines from an array to be written on the display. Only one of the parameters `\Message` or `\MsgArray` can be used at the same time.

Maximum layout space is 5 lines with 50 characters each.

`[\Wrap]`

Data type: `switch`

If selected, all the specified strings in the argument `\MsgArray` will be concatenated to one string with a single space between each individual string and spread out on as few lines as possible.

Default, each string in the argument `\MsgArray` will be on separate lines on the display.

`[\Icon]`

Data type: `icondata`

Defines the icon to be displayed. Only one of the predefined icons of type `icondata` can be used. See [Predefined data on page 1671](#).

Default, no icon.

Continues on next page

1 Instructions

1.335 WaitAO - Waits until an analog output signal value is set

RobotWare Base

Continued

[\Image]

Data type: string

The name of the image that should be used. To launch your own images, the images have to be placed in the *HOME:* directory in the active system or directly in the active system.

The recommendation is to place the files in the *HOME:* directory so that they are saved if a backup and restore is done.

A restart is required and then the FlexPendant will load the images.

A demand on the system is that the RobotWare option *FlexPendant Interface* is used.

The image that will be shown can have the width of 185 pixels and the height of 300 pixels. If the image is larger, then only 185 * 300 pixels of the image will be shown starting at the top left of the image.

No exact value can be specified on the size that an image can have or the amount of images that can be loaded to the FlexPendant. It depends on the size of other files loaded to the FlexPendant. The program execution will just continue if an image is used that has not been loaded to the FlexPendant.

[\VisualizeTime]

Data type: num

The waiting time before the message box should appear on the FlexPendant. If using the arguments `\VisualizeTime` and `\MaxTime`, the time used in argument `\MaxTime` needs to be bigger than the time used in argument `\VisualizeTime`.

The default time for the visualization if not using the argument `\VisualizeTime` is 5 s. Minimum value 1 s. Maximum value no limit. Resolution 0.001 s.

[\UIActiveSignal]

Data type: signaldo

The digital output signal used in optional argument `UIActiveSignal` is set to 1 when the visualization message box is activated on the FlexPendant. When the message box is removed (when the condition is met), the signal is set to 0 again.

No supervision of stop or restart exist. The signal is set to 0 when the instruction is ready, or when PP is moved.

[\ErrorNumber]

Error number

Data type: errnum

A variable (before used it is set to 0 by the system) that will hold the error constant if the instruction ends before the signal has the desired value.

If this optional variable is omitted then the error handler will be executed. The constants `ERR_GO_LIM`, `ERR_NO_ALIASIO_DEF`, `ERR_NORUNUNIT`, `ERR_SIG_NOT_VALID`, and `ERR_WAIT_MAXTIME` can be used to select the reason.

[\TimeOutSignal]

Data type: signaldo

Continues on next page

1.335 WaitAO - Waits until an analog output signal value is set

RobotWare Base

Continued

If `TimeOutSignal` is used, the signal is set to 0 when entering the `Wait` instruction. It is set to 1 if the instruction times out after waiting. The signal is also set to 0 when the program pointer is moved out from the `Wait` instruction.

This argument can only be used if the argument `MaxTime` is used.

[`\TimeOutGOSignal`]

Data type: `signalgo`

If `TimeOutGOSignal` is used, the signal is set to 0 when entering the `Wait` instruction. It is set to the value used in the argument `TimeOutGOValue` if the instruction times out after waiting. The signal is also set to 0 when the program pointer is moved out from the `Wait` instruction.

The optional arguments `TimeOutGOSignal` and `TimeOutGOValue` must be used together.

This argument can only be used if the argument `MaxTime` is used.

[`\TimeOutGOValue`]

Data type: `dnum`

The argument `TimeOutGOValue` holds the value that the signal in argument `TimeOutGOSignal` will be set to, if the instruction times out after waiting.

The optional arguments `TimeOutGOSignal` and `TimeOutGOValue` must be used together.

This argument can only be used if the argument `MaxTime` is used.

Program execution

If the value of the signal is correct when the instruction is executed, the program simply continues with the following instruction.

If the signal value is incorrect, the robot enters a waiting state and the program continues when the signal changes to the correct value. The change is detected with an interrupt, which gives a fast response (not polled).

When the robot is waiting, the time is supervised. By default, the robot can wait forever, but the maximal waiting time can be specified with the optional argument `\MaxTime`. If this maximum time is exceeded, an error is raised.

If program execution is stopped, and later restarted, the instruction evaluates the current value of the signal. Any change during program stop is rejected.

In manual mode, after waiting more than 3 s, an alert box will pop up asking if the instruction should be simulated. It is possible to configure the alert to not appear, by setting the system parameter *SimulateMenu* to NO, see *Technical reference manual - System parameters*, topic *Controller*, type *General RAPID*.

If the switch `\Visualize` is used, a message box is displayed on the FlexPendant according to the programmed arguments. If no `\Header` argument is used a default header text will be displayed. When the execution of the `WaitAO` instruction is ready, the message box will be removed from the FlexPendant.

New message box on trap level takes the focus from the message box on the basic level.

Continues on next page

1 Instructions

1.335 WaitAO - Waits until an analog output signal value is set

RobotWare Base

Continued

Error handling

The following recoverable errors are generated and can be handled in an error handler. The system variable `ERRNO` will be set to:

Name	Cause of error
<code>ERR_AO_LIM</code>	The programmed <code>Value</code> argument for the specified analog output signal <code>Signal</code> is outside limits.
<code>ERR_GO_LIM</code>	The programmed <code>TimeOutGOValue</code> argument for the specified digital group output signal <code>TimeOutGOSignal</code> is out of limit.
<code>ERR_NO_ALIASIO_DEF</code>	The signal variable is a variable declared in RAPID. It has not been connected to an I/O signal defined in the I/O configuration with instruction <code>AliasIO</code> .
<code>ERR_NORUNUNIT</code>	There is no contact with the I/O device.
<code>ERR_SIG_NOT_VALID</code>	The I/O signal cannot be accessed. The reasons can be that the I/O device is not running or an error in the configuration (only valid for ICI field bus).
<code>ERR_WAIT_MAXTIME</code>	There is a time-out (parameter <code>\MaxTime</code>) before the signal changes to the right value.

More examples

More examples of the instruction `WaitAO` are illustrated below.

Example 1

```
VAR num myvalattimeout:=0;
WaitAO aol, \LT, 5 \MaxTime:=4 \ValueAtTimeout:=myvalattimeout;
ERROR
  IF ERRNO=ERR_WAIT_MAXTIME THEN
    TPWrite "Value of aol at timeout:" + ValToStr(myvalattimeout);
    TRYNEXT;
  ELSE
    ! No error recovery handling
  ENDIF
```

Program execution continues only if `aol` is less than 5, or when timing out. If timing out, the value of the signal `aol` at timeout can be logged without another read of signal.

Example 2

```
WaitAO aol \GT, 5 \Visualize \Header:="Waiting for signal"
  \MsgArray:=["Movement will not start until", "the condition
  below is TRUE"] \Icon:=iconError;
MoveL p40, v500, z20, L10tip;
..
```

Continues on next page

If the condition is not met then the header and message specified in the optional arguments `\Header` and `\MsgArray` will be written on the display of the FlexPendant together with the condition that is not met.

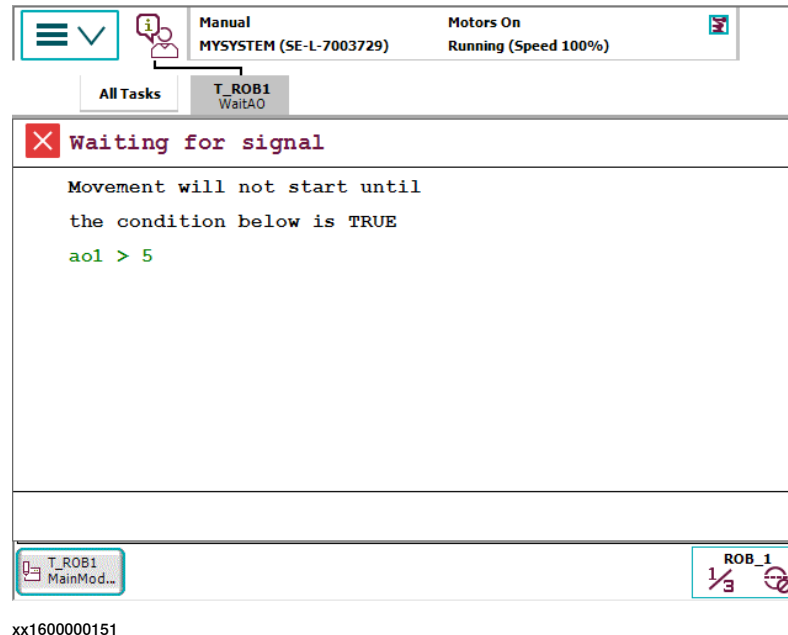

xx1600000151

Syntax

```

WaitAO
[ Signal ':= ' ] <variable (VAR) of signalao> ', '
[ '\ LT ] | [ '\ GT ] ', '
[ Value ':= ' ] <expression (IN) of num>
[ '\ MaxTime ' := <expression (IN) of num> ]
[ '\ ValueAtTimeout ' := <variable (VAR) of num> ]
[ '\ Visualize ]
[ '\ Header ' := <expression (IN) of string> ]
[ '\ Message ' := <expression (IN) of string> ]
| [ '\ MsgArray ' := <array { * } (IN) of string> ]
[ '\ Wrap ]
[ '\ Icon ' := <expression (IN) of icondata> ]
[ '\ Image ' := <expression (IN) of string> ]
[ '\ VisualizeTime ' := <expression (IN) of num> ]
[ '\ UIActiveSignal ' := <variable (VAR) of signaldo> ]
[ '\ ErrorNumber ' := <variable or persistent (INOUT) of errnum> ]
[ '\ TimeOutSignal '=' <variable (VAR) of signaldo> ]
[ '\ TimeOutGOSignal '=' <variable (VAR) of signalgo> ]
[ '\ TimeOutGOValue '=' <expression (IN) of dnum> ] ; '
    
```

Related information

For information about	See
Waiting until a condition is satisfied	WaitUntil - Waits until a condition is met on page 1079

Continues on next page

1 Instructions

1.335 WaitAO - Waits until an analog output signal value is set

RobotWare Base

Continued

For information about	See
Waiting for a specified period of time	WaitTime - Waits a given amount of time on page 1077
Waiting until an analog input is set/reset	WaitAI - Waits until an analog input signal value is set on page 1019

1.336 WaitDI - Waits until a digital input signal is set

Usage

WaitDI (*Wait Digital Input*) is used to wait until a digital input is set.

Basic examples

The following examples illustrate the instruction WaitDI:

Example 1

```
WaitDI di4, 1;
```

Program execution continues only after the di4 input has been set.

Example 2

```
WaitDI grip_status, 0;
```

Program execution continues only after the grip_status input has been reset.

Example 3

```
WaitDI di1, 1, \Visualize \Header:="Waiting for signal"
  \MsgArray:=["Movement will not start until", "the condition
  below is TRUE"] \Icon:=iconError;
MoveL p40, v500, z20, L10tip;
..
```

If the condition is not met then the header and message specified in the optional arguments \Header and \MsgArray will be written on the display of the FlexPendant together with the condition that is not met.

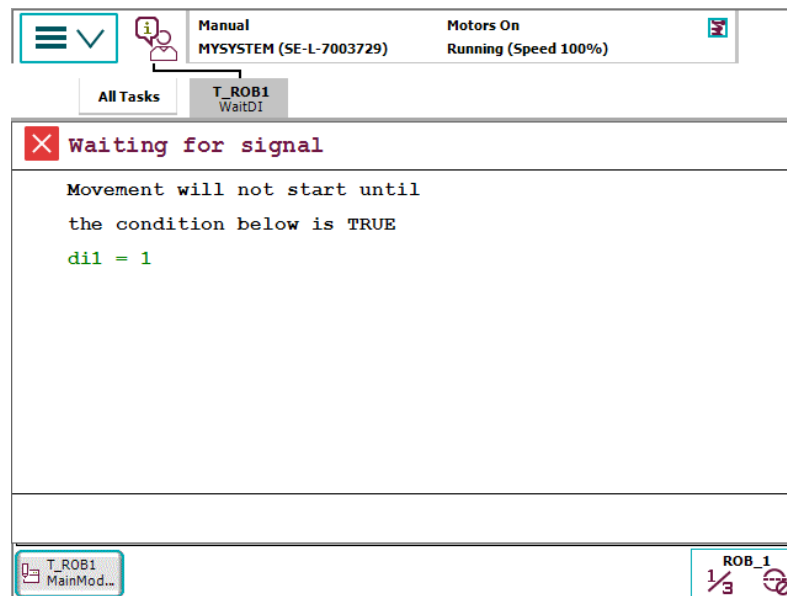

xx1600000148

Arguments

```
WaitDI Signal Value [\MaxTime] [\TimeFlag] [\Visualize] [\Header]
[\Message] | [\MsgArray] [\Wrap] [\Icon] [\Image]
[\VisualizeTime] [\UIActiveSignal] [\ErrorNumber]
[\TimeOutSignal] [\TimeOutGOSignal] [\TimeOutGOValue]
```

Continues on next page

1 Instructions

1.336 WaitDI - Waits until a digital input signal is set

RobotWare Base

Continued

Signal

Data type: `signalDI`

The name of the signal.

Value

Data type: `dionum`

The desired value of the signal.

[`\MaxTime`]

Maximum Time

Data type: `num`

The maximum period of waiting time permitted, expressed in seconds. If this time runs out before the condition is met and the `TimeFlag` argument or `ErrorNumber` argument is not used then the error handler can be called with the error code `ERR_WAIT_MAXTIME`. If there is no error handler then the execution will be stopped.

[`\TimeFlag`]

Timeout Flag

Data type: `bool`

The output parameter that contains the value `TRUE` if the maximum permitted waiting time runs out before the condition is met. If this parameter is included in the instruction then it is not considered to be an error if the maximum time runs out. This argument is ignored if the `MaxTime` argument is not included in the instruction.



Note

If both `TimeFlag` and `ErrorNumber` are used, then the `TimeFlag` is ignored. The boolean variable is not set if the instruction times out.

[`\Visualize`]

Data type: `switch`

If selected, the visualization is activated. The visualization consists of a message box with the condition that is not fulfilled, icon, header, message lines, and image is displayed according to the programmed arguments.

[`\Header`]

Data type: `string`

Header text to be written at the top of the message box. Maximum 40 characters. If no `\Header` argument is used a default message will be displayed.

[`\Message`]

Data type: `string`

One text line to be written on the display. Maximum 50 characters.

[`\MsgArray`]

(Message Array)

Data type: `string`

Continues on next page

Several text lines from an array to be written on the display. Only one of the parameters `\Message` or `\MsgArray` can be used at the same time.

Maximum layout space is 5 lines with 50 characters each.

[`\Wrap`]

Data type: `switch`

If selected, all the specified strings in the argument `\MsgArray` will be concatenated to one string with a single space between each individual string and spread out on as few lines as possible.

Default, each string in the argument `\MsgArray` will be on separate lines on the display.

[`\Icon`]

Data type: `icondata`

Defines the icon to be displayed. Only one of the predefined icons of type `icondata` can be used. See [Predefined data on page 1671](#).

Default, no icon.

[`\Image`]

Data type: `string`

The name of the image that should be used. To launch your own images, the images have to be placed in the *HOME:* directory in the active system or directly in the active system.

The recommendation is to place the files in the *HOME:* directory so that they are saved if a backup and restore is done.

A restart is required and then the FlexPendant will load the images.

A demand on the system is that the RobotWare option *FlexPendant Interface* is used.

The image that will be shown can have the width of 185 pixels and the height of 300 pixels. If the image is larger, then only 185 * 300 pixels of the image will be shown starting at the top left of the image.

No exact value can be specified on the size that an image can have or the amount of images that can be loaded to the FlexPendant. It depends on the size of other files loaded to the FlexPendant. The program execution will just continue if an image is used that has not been loaded to the FlexPendant.

[`\VisualizeTime`]

Data type: `num`

The waiting time before the message box should appear on the FlexPendant. If using the arguments `\VisualizeTime` and `\MaxTime`, the time used in argument `\MaxTime` needs to be bigger than the time used in argument `\VisualizeTime`.

The default time for the visualization if not using the argument `\VisualizeTime` is 5 s. Minimum value 1 s. Maximum value no limit. Resolution 0.001 s.

[`\UIActiveSignal`]

Data type: `signaldo`

Continues on next page

1 Instructions

1.336 WaitDI - Waits until a digital input signal is set

RobotWare Base

Continued

The digital output signal used in optional argument `UIActiveSignal` is set to 1 when the visualization message box is activated on the FlexPendant. When the message box is removed (when the condition is met), the signal is set to 0 again.

No supervision of stop or restart exist. The signal is set to 0 when the instruction is ready, or when PP is moved.

[`\ErrorNumber`]

Error number

Data type: `errnum`

A variable (before used it is set to 0 by the system) that will hold the error constant if the instruction ends before the signal has the desired value.

If this optional variable is omitted then the error handler will be executed. The constants `ERR_GO_LIM`, `ERR_NO_ALIASIO_DEF`, `ERR_NORUNUNIT`, `ERR_SIG_NOT_VALID`, and `ERR_WAIT_MAXTIME` can be used to select the reason.

[`\TimeOutSignal`]

Data type: `signaldo`

If `TimeOutSignal` is used, the signal is set to 0 when entering the `Wait` instruction. It is set to 1 if the instruction times out after waiting. The signal is also set to 0 when the program pointer is moved out from the `Wait` instruction.

This argument can only be used if the argument `MaxTime` is used.

[`\TimeOutGOSignal`]

Data type: `signalgo`

If `TimeOutGOSignal` is used, the signal is set to 0 when entering the `Wait` instruction. It is set to the value used in the argument `TimeOutGOValue` if the instruction times out after waiting. The signal is also set to 0 when the program pointer is moved out from the `Wait` instruction.

The optional arguments `TimeOutGOSignal` and `TimeOutGOValue` must be used together.

This argument can only be used if the argument `MaxTime` is used.

[`\TimeOutGOValue`]

Data type: `dnum`

The argument `TimeOutGOValue` holds the value that the signal in argument `TimeOutGOSignal` will be set to, if the instruction times out after waiting.

The optional arguments `TimeOutGOSignal` and `TimeOutGOValue` must be used together.

This argument can only be used if the argument `MaxTime` is used.

Program execution

If the value of the signal is correct, when the instruction is executed, then the program simply continues with the following instruction.

If the signal value is not correct then the robot enters a waiting state and when the signal changes to the correct value, the program continues. The change is detected with an interrupt, which gives a fast response (not polled).

Continues on next page

When the robot is waiting, the time is supervised. By default, the robot can wait forever, but the maximal waiting time can be specified with the optional argument `\MaxTime`. If this maximum time is exceeded, an error is raised.

If program execution is stopped, and later restarted, the instruction evaluates the current value of the signal. Any change during program stop is rejected.

In manual mode, after waiting more than 3 s, an alert box will pop up asking if the instruction should be simulated. It is possible to configure the alert to not appear, by setting the system parameter *SimulateMenu* to NO, see *Technical reference manual - System parameters*, topic *Controller*, type *General RAPID*.

If the switch `\Visualize` is used, a message box is displayed on the FlexPendant according to the programmed arguments. If no `\Header` argument is used a default header text will be displayed. When the execution of the `WaitDI` instruction is ready, the message box will be removed from the FlexPendant.

New message box on trap level takes the focus from the message box on the basic level.

Error handling

The following recoverable errors are generated and can be handled in an error handler. The system variable `ERRNO` will be set to:

Name	Cause of error
<code>ERR_GO_LIM</code>	The programmed <code>TimeOutGOValue</code> argument for the specified digital group output signal <code>TimeOutGOSignal</code> is out of limit.
<code>ERR_NO_ALIASIO_DEF</code>	The signal variable is a variable declared in RAPID. It has not been connected to an I/O signal defined in the I/O configuration with instruction <code>AliasIO</code> .
<code>ERR_NORUNUNIT</code>	There is no contact with the I/O device.
<code>ERR_SIG_NOT_VALID</code>	The I/O signal cannot be accessed. The reasons can be that the I/O device is not running or an error in the configuration (only valid for ICI field bus).
<code>ERR_WAIT_MAXTIME</code>	There is a time-out (parameter <code>\MaxTime</code>) before the signal changes to the right value.

Syntax

```

WaitDI
  [ Signal ':' '=' ] <variable (VAR) of signaldi> ' , '
  [ Value ':' '=' ] <expression (IN) of dionum>
  [ '\MaxTime' ':' '=' <expression (IN) of num> ]
  [ '\TimeFlag' ':' '=' <variable (VAR) of bool> ]
  [ '\ Visualize ]
  [ '\ Header ':' '=' <expression (IN) of string> ] ]
  [ '\ Message ':' '=' <expression (IN) of string> ]
  | [ '\ MsgArray ':' '=' <array {*} (IN) of string> ]
  [ '\ Wrap ]
  [ '\ Icon ':' '=' <expression (IN) of icondata> ]
  [ '\ Image ':' '=' <expression (IN) of string> ]
  [ '\ VisualizeTime ':' '=' <expression (IN) of num> ]
  [ '\ UIActiveSignal ':' '=' <variable (VAR) of signaldo> ]

```

Continues on next page

1 Instructions

1.336 WaitDI - Waits until a digital input signal is set

RobotWare Base

Continued

```
['\' ErrorNumber ':=' <variable or persistent (INOUT) of errnum>]  
['\' TimeOutSignal '=' <variable (VAR) of signaldo>]  
['\' TimeOutGOSignal '=' <variable (VAR) of signalgo>]  
['\' TimeOutGOValue '=' <expression (IN) of dnum>'];'
```

Related information

For information about	See
Waiting until a condition is satisfied	WaitUntil - Waits until a condition is met on page 1079
Waiting for a specified period of time	WaitTime - Waits a given amount of time on page 1077

1.337 WaitDO - Waits until a digital output signal is set

Usage

WaitDO (*Wait Digital Output*) is used to wait until a digital output is set.

Basic examples

The following examples illustrate the instruction WaitDO:

Example 1

```
WaitDO do4, 1;
```

Program execution continues only after the do4 output has been set.

Example 2

```
WaitDO grip_status, 0;
```

Program execution continues only after the grip_status output has been reset.

Example 3

```
WaitDO do1, 1, \Visualize \Header:="Waiting for signal"
  \MsgArray:=["Movement will not start until", "the condition
  below is TRUE"] \Icon:=iconError;
MoveL p40, v500, z20, L10tip;
..
```

If the condition is not met then the header and message specified in the optional arguments \Header and \MsgArray will be written on the display of the FlexPendant together with the condition that is not met.

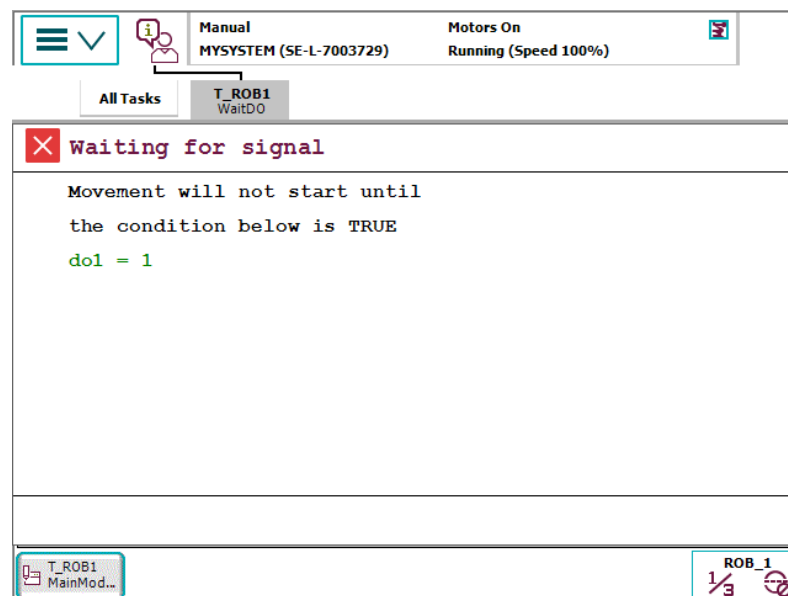

xx1600000149

Arguments

```
WaitDO Signal Value [\MaxTime] [\TimeFlag] [\Visualize] [\Header]
[\Message] | [\MsgArray] [\Wrap] [\Icon] [\Image]
[\VisualizeTime] [\UIActiveSignal] [\ErrorNumber]
[\TimeOutSignal] [\TimeOutGOSignal] [\TimeOutGOValue]
```

Continues on next page

1 Instructions

1.337 WaitDO - Waits until a digital output signal is set

RobotWare Base

Continued

Signal

Data type: `signaldo`

The name of the signal.

Value

Data type: `dionum`

The desired value of the signal.

[`\MaxTime`]

Maximum Time

Data type: `num`

The maximum period of waiting time permitted, expressed in seconds. If this time runs out before the condition is met and the `TimeFlag` argument or `ErrorNumber` argument is not used then the error handler can be called with the error code `ERR_WAIT_MAXTIME`. If there is no error handler then the execution will be stopped.

[`\TimeFlag`]

Timeout Flag

Data type: `bool`

The output parameter that contains the value `TRUE` if the maximum permitted waiting time runs out before the condition is met. If this parameter is included in the instruction then it is not considered to be an error if the maximum time runs out. This argument is ignored if the `MaxTime` argument is not included in the instruction.



Note

If both `TimeFlag` and `ErrorNumber` are used, then the `TimeFlag` is ignored. The boolean variable is not set if the instruction times out.

[`\Visualize`]

Data type: `switch`

If selected, the visualization is activated. The visualization consists of a message box with the condition that is not fulfilled, icon, header, message lines, and image is displayed according to the programmed arguments.

[`\Header`]

Data type: `string`

Header text to be written at the top of the message box. Maximum 40 characters. If no `\Header` argument is used a default message will be displayed.

[`\Message`]

Data type: `string`

One text line to be written on the display. Maximum 50 characters.

[`\MsgArray`]

(Message Array)

Data type: `string`

Continues on next page

Several text lines from an array to be written on the display. Only one of the parameters `\Message` or `\MsgArray` can be used at the same time.

Maximum layout space is 5 lines with 50 characters each.

[`\Wrap`]

Data type: `switch`

If selected, all the specified strings in the argument `\MsgArray` will be concatenated to one string with a single space between each individual string and spread out on as few lines as possible.

Default, each string in the argument `\MsgArray` will be on separate lines on the display.

[`\Icon`]

Data type: `icondata`

Defines the icon to be displayed. Only one of the predefined icons of type `icondata` can be used. See [Predefined data on page 1671](#).

Default, no icon.

[`\Image`]

Data type: `string`

The name of the image that should be used. To launch your own images, the images have to be placed in the *HOME:* directory in the active system or directly in the active system.

The recommendation is to place the files in the *HOME:* directory so that they are saved if a backup and restore is done.

A restart is required and then the FlexPendant will load the images.

A demand on the system is that the RobotWare option *FlexPendant Interface* is used.

The image that will be shown can have the width of 185 pixels and the height of 300 pixels. If the image is larger, then only 185 * 300 pixels of the image will be shown starting at the top left of the image.

No exact value can be specified on the size that an image can have or the amount of images that can be loaded to the FlexPendant. It depends on the size of other files loaded to the FlexPendant. The program execution will just continue if an image is used that has not been loaded to the FlexPendant.

[`\VisualizeTime`]

Data type: `num`

The waiting time before the message box should appear on the FlexPendant. If using the arguments `\VisualizeTime` and `\MaxTime`, the time used in argument `\MaxTime` needs to be bigger than the time used in argument `\VisualizeTime`.

The default time for the visualization if not using the argument `\VisualizeTime` is 5 s. Minimum value 1 s. Maximum value no limit. Resolution 0.001 s.

[`\UIActiveSignal`]

Data type: `signaldo`

Continues on next page

1 Instructions

1.337 WaitDO - Waits until a digital output signal is set

RobotWare Base

Continued

The digital output signal used in optional argument `UIActiveSignal` is set to 1 when the visualization message box is activated on the FlexPendant. When the message box is removed (when the condition is met), the signal is set to 0 again.

No supervision of stop or restart exist. The signal is set to 0 when the instruction is ready, or when PP is moved.

[`\ErrorNumber`]

Error number

Data type: `errnum`

A variable (before used it is set to 0 by the system) that will hold the error constant if the instruction ends before the signal has the desired value.

If this optional variable is omitted then the error handler will be executed. The constants `ERR_GO_LIM`, `ERR_NO_ALIASIO_DEF`, `ERR_NORUNUNIT`, `ERR_SIG_NOT_VALID`, and `ERR_WAIT_MAXTIME` can be used to select the reason.

[`\TimeOutSignal`]

Data type: `signaldo`

If `TimeOutSignal` is used, the signal is set to 0 when entering the `Wait` instruction. It is set to 1 if the instruction times out after waiting. The signal is also set to 0 when the program pointer is moved out from the `Wait` instruction.

This argument can only be used if the argument `MaxTime` is used.

[`\TimeOutGOSignal`]

Data type: `signalgo`

If `TimeOutGOSignal` is used, the signal is set to 0 when entering the `Wait` instruction. It is set to the value used in the argument `TimeOutGOValue` if the instruction times out after waiting. The signal is also set to 0 when the program pointer is moved out from the `Wait` instruction.

The optional arguments `TimeOutGOSignal` and `TimeOutGOValue` must be used together.

This argument can only be used if the argument `MaxTime` is used.

[`\TimeOutGOValue`]

Data type: `dnum`

The argument `TimeOutGOValue` holds the value that the signal in argument `TimeOutGOSignal` will be set to, if the instruction times out after waiting.

The optional arguments `TimeOutGOSignal` and `TimeOutGOValue` must be used together.

This argument can only be used if the argument `MaxTime` is used.

Program execution

If the value of the output signal is correct, when the instruction is executed, then the program simply continues with the following instruction.

If the value of the output signal is not correct then the robot enters a waiting state. When the signal changes to the correct value then the program continues. The change is detected with an interrupt, which gives a fast response (not polled).

Continues on next page

When the robot is waiting, the time is supervised. By default, the robot can wait forever, but the maximal waiting time can be specified with the optional argument `\MaxTime`. If this maximum time is exceeded, an error is raised.

If program execution is stopped, and later restarted, the instruction evaluates the current value of the signal. Any change during program stop is rejected.

In manual mode, after waiting more than 3 s, an alert box will pop up asking if the instruction should be simulated. It is possible to configure the alert to not appear, by setting the system parameter *SimulateMenu* to NO, see *Technical reference manual - System parameters*, topic *Controller*, type *General RAPID*.

If the switch `\Visualize` is used, a message box is displayed on the FlexPendant according to the programmed arguments. If no `\Header` argument is used a default header text will be displayed. When the execution of the `WaitDO` instruction is ready, the message box will be removed from the FlexPendant.

New message box on trap level takes the focus from the message box on the basic level.

Error handling

The following recoverable errors are generated and can be handled in an error handler. The system variable `ERRNO` will be set to:

Name	Cause of error
<code>ERR_GO_LIM</code>	The programmed <code>TimeOutGOValue</code> argument for the specified digital group output signal <code>TimeOutGOSignal</code> is out of limit.
<code>ERR_NO_ALIASIO_DEF</code>	The signal variable is a variable declared in RAPID. It has not been connected to an I/O signal defined in the I/O configuration with instruction <code>AliasIO</code> .
<code>ERR_NORUNUNIT</code>	There is no contact with the I/O device.
<code>ERR_SIG_NOT_VALID</code>	The I/O signal cannot be accessed. The reasons can be that the I/O device is not running or an error in the configuration (only valid for ICI field bus).
<code>ERR_WAIT_MAXTIME</code>	There is a time-out (parameter <code>\MaxTime</code>) before the signal changes to the right value.

Syntax

```

WaitDO
  [ Signal '[:=' ] <variable (VAR) of signaldo>', '
  [ Value '[:=' ] <expression (IN) of dionum>
  [ '\MaxTime' '[:=' <expression (IN) of num> ]
  [ '\TimeFlag' '[:=' <variable (VAR) of bool> ]
  [ '\ Visualize ]
  [ '\ Header '[:=' <expression (IN) of string> ] ]
  [ '\ Message '[:=' <expression (IN) of string> ]
  | [ '\ MsgArray '[:=' <array {*} (IN) of string> ]
  [ '\ Wrap ]
  [ '\ Icon '[:=' <expression (IN) of icondata> ]
  [ '\ Image '[:=' <expression (IN) of string> ]
  [ '\ VisualizeTime '[:=' <expression (IN) of num> ]
  [ '\ UIActiveSignal '[:=' <variable (VAR) of signaldo> ]

```

Continues on next page

1 Instructions

1.337 WaitDO - Waits until a digital output signal is set

RobotWare Base

Continued

```
['\' ErrorNumber ':=' <variable or persistent (INOUT) of errnum>]  
['\' TimeOutSignal '=' <variable (VAR) of signaldo>]  
['\' TimeOutGOSignal '=' <variable (VAR) of signalgo>]  
['\' TimeOutGOValue '=' <expression (IN) of dnum>'];'
```

Related information

For information about	See
Waiting until a condition is satisfied	WaitUntil - Waits until a condition is met on page 1079
Waiting for a specified period of time	WaitTime - Waits a given amount of time on page 1077
Waiting until an input is set/reset	WaitDI - Waits until a digital input signal is set on page 1033

1.338 WaitGI - Waits until a group of digital input signals are set

Usage

WaitGI (*Wait Group digital Input*) is used to wait until a group of digital input signals are set to specified values.

Basic examples

The following example illustrates the instruction WaitGI:

See also [More examples on page 1049](#).

Example 1

```
WaitGI gi4, 5;
```

Program execution continues only after the gi4 input has the value 5.

Example 2

```
WaitGI grip_status, 0;
```

Program execution continues only after the grip_status input has been reset.

Arguments

```
WaitGI Signal [\NOTEQ] | [\LT] | [\GT] Value | Dvalue [\MaxTime]
[\ValueAtTimeout] | [\DvalueAtTimeout] [\Visualize] [\Header]
[\Message] | [\MsgArray] [\Wrap] [\Icon] [\Image]
[\VisualizeTime] [\UIActiveSignal] [\ErrorNumber]
[\TimeOutSignal] [\TimeOutGOSignal] [\TimeOutGOValue]
```

Signal

Data type: signalgi

The name of the digital group input signal.

[\NOTEQ]

NOT Equal

Data type: switch

If using this parameter, the WaitGI instruction waits until the digital group signal value divides from the value in Value.

[\LT]

Less Than

Data type: switch

If using this parameter, the WaitGI instruction waits until the digital group signal value is less than the value in Value.

[\GT]

Greater Than

Data type: switch

If using this parameter, the WaitGI instruction waits until the digital group signal value is greater than the value in Value.

Continues on next page

1 Instructions

1.338 WaitGI - Waits until a group of digital input signals are set

RobotWare Base

Continued

Value

Data type: num

The desired value of the signal. Must be an integer value within the working range of the used digital group input signal. The permitted value is dependent on the number of signals in the group. Max value that can be used in the Value argument is 8388608, and that is the value a 23 bit digital signal can have as maximum value.

Dvalue

Data type: dnum

The desired value of the signal. Must be an integer value within the working range of the used digital group input signal. The permitted value is dependent on the number of signals in the group. The maximal amount of signal bits a digital group signal can have is 32. With a dnum variable it is possible to cover the value range 0-4294967295, which is the value range a 32 bits digital signal can have.

[\MaxTime]

Maximum Time

Data type: num

The maximum period of waiting time permitted, expressed in seconds. If this time runs out before the condition is met, the error handler will be called (if there is one) with the error code ERR_WAIT_MAXTIME. If there is no error handler, the execution will be stopped.

[\ValueAtTimeout]

Data type: num

If the instruction time-out, the current signal value will be stored in this variable. The variable will only be set if the system variable ERRNO is set to ERR_WAIT_MAXTIME. If the Dvalue argument is used, use argument DvalueAtTimeout to store current value on signal (reason: limitation of maximum integer value for num).

Signal values between 0 and 8388608 are always stored as an exact integer.

[\DvalueAtTimeout]

Data type: dnum

If the instruction time-out, the current signal value will be stored in this variable. The variable will only be set if the system variable ERRNO is set to ERR_WAIT_MAXTIME.

Signal values between 0 and 4294967295 are always stored as an exact integer.

[\Visualize]

Data type: switch

If selected, the visualization is activated. The visualization consists of a message box with the condition that is not fulfilled, icon, header, message lines, and image is displayed according to the programmed arguments.

[\Header]

Data type: string

Continues on next page

Header text to be written at the top of the message box. Maximum 40 characters. If no `\Header` argument is used a default message will be displayed.

[`\Message`]

Data type: `string`

One text line to be written on the display. Maximum 50 characters.

[`\MsgArray`]

(Message Array)

Data type: `string`

Several text lines from an array to be written on the display. Only one of the parameters `\Message` or `\MsgArray` can be used at the same time.

Maximum layout space is 5 lines with 50 characters each.

[`\Wrap`]

Data type: `switch`

If selected, all the specified strings in the argument `\MsgArray` will be concatenated to one string with a single space between each individual string and spread out on as few lines as possible.

Default, each string in the argument `\MsgArray` will be on separate lines on the display.

[`\Icon`]

Data type: `icondata`

Defines the icon to be displayed. Only one of the predefined icons of type `icondata` can be used. See [Predefined data on page 1671](#).

Default, no icon.

[`\Image`]

Data type: `string`

The name of the image that should be used. To launch your own images, the images have to be placed in the *HOME:* directory in the active system or directly in the active system.

The recommendation is to place the files in the *HOME:* directory so that they are saved if a backup and restore is done.

A restart is required and then the FlexPendant will load the images.

A demand on the system is that the RobotWare option *FlexPendant Interface* is used.

The image that will be shown can have the width of 185 pixels and the height of 300 pixels. If the image is larger, then only 185 * 300 pixels of the image will be shown starting at the top left of the image.

No exact value can be specified on the size that an image can have or the amount of images that can be loaded to the FlexPendant. It depends on the size of other files loaded to the FlexPendant. The program execution will just continue if an image is used that has not been loaded to the FlexPendant.

Continues on next page

1 Instructions

1.338 WaitGI - Waits until a group of digital input signals are set

RobotWare Base

Continued

[`\VisualizeTime`]

Data type: num

The waiting time before the message box should appear on the FlexPendant. If using the arguments `\VisualizeTime` and `\MaxTime`, the time used in argument `\MaxTime` needs to be bigger than the time used in argument `\VisualizeTime`.

The default time for the visualization if not using the argument `\VisualizeTime` is 5 s. Minimum value 1 s. Maximum value no limit. Resolution 0.001 s.

[`\UIActiveSignal`]

Data type: signaldo

The digital output signal used in optional argument `UIActiveSignal` is set to 1 when the visualization message box is activated on the FlexPendant. When the message box is removed (when the condition is met), the signal is set to 0 again.

No supervision of stop or restart exist. The signal is set to 0 when the instruction is ready, or when PP is moved.

[`\ErrorNumber`]

Error number

Data type: errnum

A variable (before used it is set to 0 by the system) that will hold the error constant if the instruction ends before the signal has the desired value.

If this optional variable is omitted then the error handler will be executed. The constants `ERR_GO_LIM`, `ERR_NO_ALIASIO_DEF`, `ERR_NORUNUNIT`, `ERR_SIG_NOT_VALID`, and `ERR_WAIT_MAXTIME` can be used to select the reason.

[`\TimeOutSignal`]

Data type: signaldo

If `TimeOutSignal` is used, the signal is set to 0 when entering the `Wait` instruction. It is set to 1 if the instruction times out after waiting. The signal is also set to 0 when the program pointer is moved out from the `Wait` instruction.

This argument can only be used if the argument `MaxTime` is used.

[`\TimeOutGOSignal`]

Data type: signalgo

If `TimeOutGOSignal` is used, the signal is set to 0 when entering the `Wait` instruction. It is set to the value used in the argument `TimeOutGOValue` if the instruction times out after waiting. The signal is also set to 0 when the program pointer is moved out from the `Wait` instruction.

The optional arguments `TimeOutGOSignal` and `TimeOutGOValue` must be used together.

This argument can only be used if the argument `MaxTime` is used.

[`\TimeOutGOValue`]

Data type: dnum

The argument `TimeOutGOValue` holds the value that the signal in argument `TimeOutGOSignal` will be set to, if the instruction times out after waiting.

Continues on next page

1.338 WaitGI - Waits until a group of digital input signals are set

*RobotWare Base**Continued*

The optional arguments `TimeOutGOSignal` and `TimeOutGOValue` must be used together.

This argument can only be used if the argument `MaxTime` is used.

Program execution

If the value of the signal is correct when the instruction is executed, the program simply continues with the following instruction.

If the signal value is not correct, the robot enters a waiting state and the program continues when the signal changes to the correct value. The change is detected with an interrupt, which gives a fast response (not polled).

When the robot is waiting, the time is supervised. By default, the robot can wait forever, but the maximal waiting time can be specified with the optional argument `\MaxTime`. If this maximum time is exceeded, an error is raised.

If program execution is stopped, and later restarted, the instruction evaluates the current value of the signal. Any change during program stop is rejected.

In manual mode, after waiting more than 3 s, an alert box will pop up asking if the instruction should be simulated. It is possible to configure the alert to not appear, by setting the system parameter *SimulateMenu* to NO, see *Technical reference manual - System parameters*, topic *Controller*, type *General RAPID*.

If the switch `\Visualize` is used, a message box is displayed on the FlexPendant according to the programmed arguments. If no `\Header` argument is used a default header text will be displayed. When the execution of the `WaitGI` instruction is ready, the message box will be removed from the FlexPendant.

New message box on trap level takes the focus from the message box on the basic level.

Error handling

The following recoverable errors are generated and can be handled in an error handler. The system variable `ERRNO` will be set to:

Name	Cause of error
<code>ERR_GO_LIM</code>	The programmed group signal value argument for a digital group output signal is out of limit.
<code>ERR_NO_ALIASIO_DEF</code>	The signal variable is a variable declared in RAPID. It has not been connected to an I/O signal defined in the I/O configuration with instruction <code>AliasIO</code> .
<code>ERR_NORUNUNIT</code>	There is no contact with the I/O device.
<code>ERR_SIG_NOT_VALID</code>	The I/O signal cannot be accessed. The reasons can be that the I/O device is not running or an error in the configuration (only valid for ICI field bus).
<code>ERR_WAIT_MAXTIME</code>	There is a time-out (parameter <code>\MaxTime</code>) before the signal changes to the right value.

More examples

More examples of the instruction `WaitGI` are illustrated below.

Example 1

```
WaitGI gil,\NOTEQ,0;
```

Continues on next page

1 Instructions

1.338 WaitGI - Waits until a group of digital input signals are set

RobotWare Base

Continued

Program execution only continues after the `gil` differs from the value 0.

Example 2

```
WaitGI gil,\LT,1;
```

Program execution only continues after the `gil` is less than 1.

Example 3

```
WaitGI gil,\GT,0;
```

Program execution continues only after the `gil` is greater than 0.

Example 4

```
VAR num myvalattimeout:=0;
WaitGI gil, 5 \MaxTime:=4 \ValueAtTimeout:=myvalattimeout;
ERROR
  IF ERRNO=ERR_WAIT_MAXTIME THEN
    TPWrite "Value of gil at timeout:" + ValToStr(myvalattimeout);
    TRYNEXT;
  ELSE
    ! No error recovery handling
  ENDIF
```

Program execution continues only if `gil` is equal to 5, or when timing out. If timing out, the value of the signal `gil` at timeout can be logged without another read of signal.

Example 5

```
WaitGI gil, 4, \Visualize \Header:="Waiting for signal"
  \MsgArray:["Movement will not start until", "the condition
  below is TRUE"] \Icon:=iconError;
MoveL p40, v500, z20, L10tip;
..
```

Continues on next page

If the condition is not met then the header and message specified in the optional arguments `\Header` and `\MsgArray` will be written on the display of the FlexPendant together with the condition that is not met.

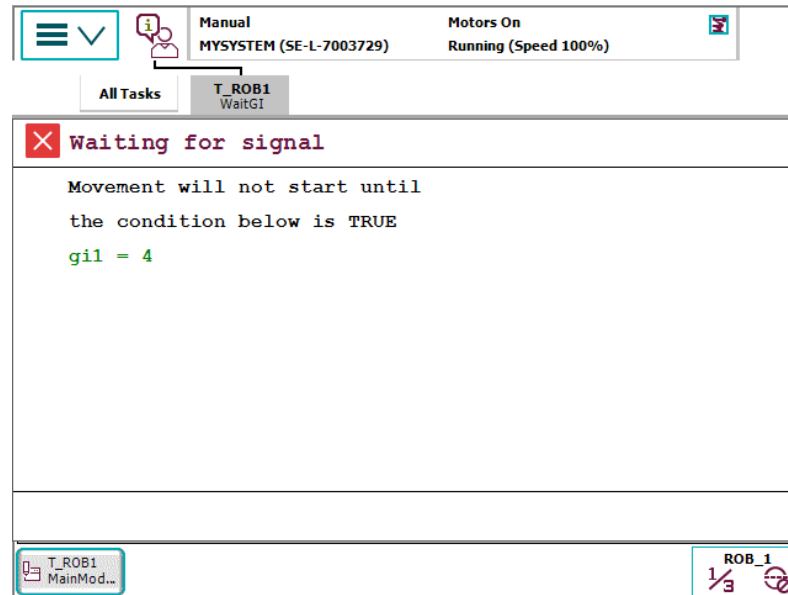

xx1600000152

Syntax

WaitGI

```
[ Signal ':' ] <variable (VAR) of signalgi> ','
[ '\ NOTEQ ] | [ '\ LT ] | [ '\ GT ] ','
[ Value ':' ] <expression (IN) of num>
| [ Dvalue ':' ] <expression (IN) of dnum>
[ '\ MaxTime ':' ] <expression (IN) of num>
[ '\ ValueAtTimeout ':' ] <variable (VAR) of num> ]
| [ '\ DvalueAtTimeout ':' ] <variable (VAR) of dnum> ]
[ '\ Visualize ]
[ '\ Header ':' ] <expression (IN) of string>]
[ '\ Message ':' ] <expression (IN) of string>]
| [ '\ MsgArray ':' ] <array {*} (IN) of string>]
[ '\ Wrap ]
[ '\ Icon ':' ] <expression (IN) of icondata>]
[ '\ Image ':' ] <expression (IN) of string>]
[ '\ VisualizeTime ':' ] <expression (IN) of num>]
[ '\ UIActiveSignal ':' ] <variable (VAR) of signaldo>]
[ '\ ErrorNumber ':' ] <variable or persistent (INOUT) of errnum>]
[ '\ TimeOutSignal '=' ] <variable (VAR) of signaldo>]
[ '\ TimeOutGOSignal '=' ] <variable (VAR) of signalgo>]
[ '\ TimeOutGOValue '=' ] <expression (IN) of dnum>]';'
```

Related information

For information about	See
Waiting until a condition is satisfied	WaitUntil - Waits until a condition is met on page 1079

Continues on next page

1 Instructions

1.338 WaitGI - Waits until a group of digital input signals are set

RobotWare Base

Continued

For information about	See
Waiting for a specified period of time	WaitTime - Waits a given amount of time on page 1077
Waiting until a group of digital output signals are set/reset	WaitGO - Waits until a group of digital output signals are set on page 1053

1.339 WaitGO - Waits until a group of digital output signals are set

Usage

WaitGO (*Wait Group digital Output*) is used to wait until a group of digital output signals are set to a specified value.

Basic examples

The following examples illustrate the instruction WaitGO:

See also [More examples on page 1057](#).

Example 1

```
WaitGO go4, 5;
```

Program execution only continues after the go4 output has value 5.

Example 2

```
WaitGO grip_status, 0;
```

Program execution only continues after the grip_status output has been reset.

Arguments

```
WaitGO Signal [\NOTEQ] | [\LT] | [\GT] Value | Dvalue [\MaxTime]
[\ValueAtTimeout] | [\DvalueAtTimeout] [\Visualize] [\Header]
[\Message] | [\MsgArray] [\Wrap] [\Icon] [\Image]
[\VisualizeTime] [\UIActiveSignal] [\ErrorNumber]
[\TimeOutSignal] [\TimeOutGOSignal] [\TimeOutGOValue]
```

Signal

Data type: signalgo

The name of the digital group output signal.

[\NOTEQ]

NOT Equal

Data type: switch

If using this parameter, the WaitGO instruction waits until the digital group signal value divides from the value in Value.

[\LT]

Less Than

Data type: switch

If using this parameter, the WaitGO instruction waits until the digital group signal value is less than the value in Value.

[\GT]

Greater Than

Data type: switch

If using this parameter, the WaitGO instruction waits until the digital group signal value is greater than the value in Value.

Continues on next page

1 Instructions

1.339 WaitGO - Waits until a group of digital output signals are set

RobotWare Base

Continued

Value

Data type: num

The desired value of the signal. Must be an integer value within the working range of the used digital group output signal. The permitted value is dependent on the number of signals in the group. Max value that can be used in the Value argument is 8388608, and that is the value a 23 bit digital signal can have as maximum value.

Dvalue

Data type: dnum

The desired value of the signal. Must be an integer value within the working range of the used digital group output signal. The permitted value is dependent on the number of signals in the group. The maximal amount of signal bits a digital group signal can have is 32. With a dnum variable it is possible to cover the value range 0-4294967295, which is the value range a 32 bits digital signal can have.

[\MaxTime]

Maximum Time

Data type: num

The maximum period of waiting time permitted, expressed in seconds. If this time runs out before the condition is met, the error handler will be called, if there is one, with the error code ERR_WAIT_MAXTIME. If there is no error handler, the execution will be stopped.

[\ValueAtTimeout]

Data type: num

If the instruction time-out, the current signal value will be stored in this variable. The variable will only be set if the system variable ERRNO is set to ERR_WAIT_MAXTIME. If the Dvalue argument is used, use argument DvalueAtTimeout to store current value on signal (reason: limitation of maximum integer value for num).

Signal values between 0 and 8388608 are always stored as an exact integer.

[\DvalueAtTimeout]

Data type: dnum

If the instruction time-out, the current signal value will be stored in this variable. The variable will only be set if the system variable ERRNO is set to ERR_WAIT_MAXTIME.

Signal values between 0 and 4294967295 are always stored as an exact integer.

[\Visualize]

Data type: switch

If selected, the visualization is activated. The visualization consists of a message box with the condition that is not fulfilled, icon, header, message lines, and image is displayed according to the programmed arguments.

[\Header]

Data type: string

Continues on next page

Header text to be written at the top of the message box. Maximum 40 characters. If no `\Header` argument is used a default message will be displayed.

[`\Message`]

Data type: `string`

One text line to be written on the display. Maximum 50 characters.

[`\MsgArray`]

(Message Array)

Data type: `string`

Several text lines from an array to be written on the display. Only one of the parameters `\Message` or `\MsgArray` can be used at the same time.

Maximum layout space is 5 lines with 50 characters each.

[`\Wrap`]

Data type: `switch`

If selected, all the specified strings in the argument `\MsgArray` will be concatenated to one string with a single space between each individual string and spread out on as few lines as possible.

Default, each string in the argument `\MsgArray` will be on separate lines on the display.

[`\Icon`]

Data type: `icondata`

Defines the icon to be displayed. Only one of the predefined icons of type `icondata` can be used. See [Predefined data on page 1671](#).

Default, no icon.

[`\Image`]

Data type: `string`

The name of the image that should be used. To launch your own images, the images have to be placed in the *HOME:* directory in the active system or directly in the active system.

The recommendation is to place the files in the *HOME:* directory so that they are saved if a backup and restore is done.

A restart is required and then the FlexPendant will load the images.

A demand on the system is that the RobotWare option *FlexPendant Interface* is used.

The image that will be shown can have the width of 185 pixels and the height of 300 pixels. If the image is larger, then only 185 * 300 pixels of the image will be shown starting at the top left of the image.

No exact value can be specified on the size that an image can have or the amount of images that can be loaded to the FlexPendant. It depends on the size of other files loaded to the FlexPendant. The program execution will just continue if an image is used that has not been loaded to the FlexPendant.

Continues on next page

1 Instructions

1.339 WaitGO - Waits until a group of digital output signals are set

RobotWare Base

Continued

[`\VisualizeTime`]

Data type: num

The waiting time before the message box should appear on the FlexPendant. If using the arguments `\VisualizeTime` and `\MaxTime`, the time used in argument `\MaxTime` needs to be bigger than the time used in argument `\VisualizeTime`.

The default time for the visualization if not using the argument `\VisualizeTime` is 5 s. Minimum value 1 s. Maximum value no limit. Resolution 0.001 s.

[`\UIActiveSignal`]

Data type: signaldo

The digital output signal used in optional argument `UIActiveSignal` is set to 1 when the visualization message box is activated on the FlexPendant. When the message box is removed (when the condition is met), the signal is set to 0 again.

No supervision of stop or restart exist. The signal is set to 0 when the instruction is ready, or when PP is moved.

[`\ErrorNumber`]

Error number

Data type: errnum

A variable (before used it is set to 0 by the system) that will hold the error constant if the instruction ends before the signal has the desired value.

If this optional variable is omitted then the error handler will be executed. The constants `ERR_GO_LIM`, `ERR_NO_ALIASIO_DEF`, `ERR_NORUNUNIT`, `ERR_SIG_NOT_VALID`, and `ERR_WAIT_MAXTIME` can be used to select the reason.

[`\TimeOutSignal`]

Data type: signaldo

If `TimeOutSignal` is used, the signal is set to 0 when entering the `Wait` instruction. It is set to 1 if the instruction times out after waiting. The signal is also set to 0 when the program pointer is moved out from the `Wait` instruction.

This argument can only be used if the argument `MaxTime` is used.

[`\TimeOutGOSignal`]

Data type: signalgo

If `TimeOutGOSignal` is used, the signal is set to 0 when entering the `Wait` instruction. It is set to the value used in the argument `TimeOutGOValue` if the instruction times out after waiting. The signal is also set to 0 when the program pointer is moved out from the `Wait` instruction.

The optional arguments `TimeOutGOSignal` and `TimeOutGOValue` must be used together.

This argument can only be used if the argument `MaxTime` is used.

[`\TimeOutGOValue`]

Data type: dnum

The argument `TimeOutGOValue` holds the value that the signal in argument `TimeOutGOSignal` will be set to, if the instruction times out after waiting.

Continues on next page

1.339 WaitGO - Waits until a group of digital output signals are set

RobotWare Base

Continued

The optional arguments `TimeOutGOSignal` and `TimeOutGOValue` must be used together.

This argument can only be used if the argument `MaxTime` is used.

Program execution

If the value of the signal is correct when the instruction is executed, the program simply continues with the following instruction.

If the signal value is incorrect, the robot enters a waiting state and the program continues when the signal changes to the correct value. The change is detected with an interrupt, which gives a fast response (not polled).

When the robot is waiting, the time is supervised. By default, the robot can wait forever, but the maximal waiting time can be specified with the optional argument `\MaxTime`. If this maximum time is exceeded, an error is raised.

If program execution is stopped, and later restarted, the instruction evaluates the current value of the signal. Any change during program stop is rejected.

In manual mode, after waiting more than 3 s, an alert box will pop up asking if the instruction should be simulated. It is possible to configure the alert to not appear, by setting the system parameter `SimulateMenu` to NO, see *Technical reference manual - System parameters*, topic *Controller*, type *General RAPID*.

If the switch `\Visualize` is used, a message box is displayed on the FlexPendant according to the programmed arguments. If no `\Header` argument is used a default header text will be displayed. When the execution of the `WaitGO` instruction is ready, the message box will be removed from the FlexPendant.

New message box on trap level takes the focus from the message box on the basic level.

Error handling

The following recoverable errors are generated and can be handled in an error handler. The system variable `ERRNO` will be set to:

Name	Cause of error
<code>ERR_GO_LIM</code>	The programmed group signal value argument for a digital group output signal is out of limit.
<code>ERR_NO_ALIASIO_DEF</code>	The signal variable is a variable declared in RAPID. It has not been connected to an I/O signal defined in the I/O configuration with instruction <code>AliasIO</code> .
<code>ERR_NORUNUNIT</code>	There is no contact with the I/O device.
<code>ERR_SIG_NOT_VALID</code>	The I/O signal cannot be accessed. The reasons can be that the I/O device is not running or an error in the configuration (only valid for ICI field bus).
<code>ERR_WAIT_MAXTIME</code>	There is a time-out (parameter <code>\MaxTime</code>) before the signal changes to the right value.

More examples

More examples of the instruction `WaitGO` are illustrated below.

Example 1

```
WaitGO gol,\NOTEQ,0;
```

Continues on next page

1 Instructions

1.339 WaitGO - Waits until a group of digital output signals are set

RobotWare Base

Continued

Program execution only continues after the `go1` differs from the value 0.

Example 2

```
WaitGO go1,\LT,1;
```

Program execution only continues after the `go1` is less than 1.

Example 3

```
WaitGO go1,\GT,0;
```

Program execution only continues after the `go1` is greater than 0.

Example 4

```
VAR num myvalattimeout:=0;
WaitGO go1, 5 \MaxTime:=4 \ValueAtTimeout:=myvalattimeout;
ERROR
  IF ERRNO=ERR_WAIT_MAXTIME THEN
    TPWrite "Value of go1 at timeout:" + ValToStr(myvalattimeout);
    TRYNEXT;
  ELSE
    ! No error recovery handling
  ENDIF
```

Program execution continues only if `go1` is equal to 5, or when timing out. If timing out, the value of the signal `go1` at timeout can be logged without another read of signal.

Example 5

```
WaitGO go1, 4, \Visualize \Header:="Waiting for signal"
  \MsgArray:["Movement will not start until", "the condition
  below is TRUE"] \Icon:=iconError;
MoveL p40, v500, z20, L10tip;
..
```

Continues on next page

1.339 WaitGO - Waits until a group of digital output signals are set

RobotWare Base

Continued

If the condition is not met then the header and message specified in the optional arguments `\Header` and `\MsgArray` will be written on the display of the FlexPendant together with the condition that is not met.

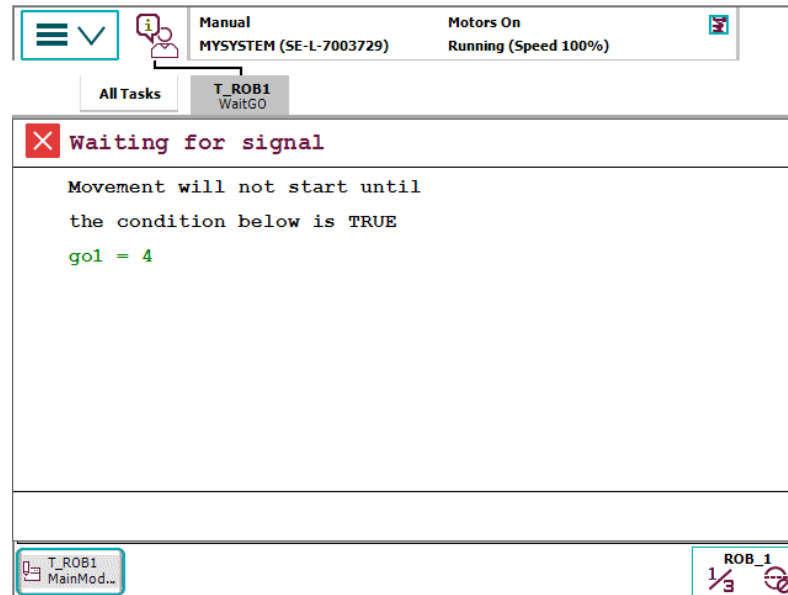

xx1600000153

Syntax

```

WaitGO
[ Signal ':' '=' ] <variable (VAR) of signalgo> ','
[ '\ ' NOTEQ ] | [ '\ ' LT ] | [ '\ ' GT ] ','
[ Value ':' '=' ] <expression (IN) of num>
| [ Dvalue ':' '=' ] <expression (IN) of dnum>
[ '\ ' MaxTime ':' '=' <expression (IN) of num> ]
[ '\ ' ValueAtTimeout ':' '=' <variable (VAR) of num> ]
| [ '\ ' DvalueAtTimeout ':' '=' <variable (VAR) of dnum> ]
[ '\ ' Visualize ]
[ '\ ' Header ':' '=' <expression (IN) of string> ]
[ '\ ' Message ':' '=' <expression (IN) of string> ]
| [ '\ ' MsgArray ':' '=' <array {*} (IN) of string> ]
[ '\ ' Wrap ]
[ '\ ' Icon ':' '=' <expression (IN) of icondata> ]
[ '\ ' Image ':' '=' <expression (IN) of string> ]
[ '\ ' VisualizeTime ':' '=' <expression (IN) of num> ]
[ '\ ' UIActiveSignal ':' '=' <variable (VAR) of signaldo> ]
[ '\ ' ErrorNumber ':' '=' <variable or persistent (INOUT) of errnum> ]
[ '\ ' TimeOutSignal '=' <variable (VAR) of signaldo> ]
[ '\ ' TimeOutGOSignal '=' <variable (VAR) of signalgo> ]
[ '\ ' TimeOutGOValue '=' <expression (IN) of dnum> ]';'

```

Related information

For information about	See
Waiting until a condition is satisfied	WaitUntil - Waits until a condition is met on page 1079

Continues on next page

1 Instructions

1.339 WaitGO - Waits until a group of digital output signals are set

RobotWare Base

Continued

For information about	See
Waiting for a specified period of time	WaitTime - Waits a given amount of time on page 1077
Waiting until a group of digital input signals are set/reset	WaitGI - Waits until a group of digital input signals are set on page 1045

1.340 WaitLoad - Connect the loaded module to the task

Usage

WaitLoad is used to connect with the module that is loaded with the instruction StartLoad to the program task.

The loaded program module will be added to the modules already existing in the program memory.

A module that is loaded with StartLoad must be connected to the program task with the instruction WaitLoad before any of its symbols or routines can be used.

WaitLoad can also unload a program module if the optional switches are used. This will minimize the number of links (1 instead of 2).

WaitLoad can also check for any unsolved references if the optional switch \CheckRef is used.

Basic examples

The following example illustrates the instruction WaitLoad:

See also [More examples on page 1063](#).

Example 1

```
VAR loadsession load1;
...
StartLoad "HOME:/PART_A.MOD", load1;
MoveL p10, v1000, z50, tool1 \WObj:=wobj1;
MoveL p20, v1000, z50, tool1 \WObj:=wobj1;
MoveL p30, v1000, z50, tool1 \WObj:=wobj1;
MoveL p40, v1000, z50, tool1 \WObj:=wobj1;
WaitLoad load1;
%"routine_x"%;
Unload "HOME:/PART_A.MOD";
```

Load the program module PART_A.MOD from HOME: into the program memory. In parallel, move the robot. Then connect the new program module to the program task and call the routine routine_x in the module PART_A.

Arguments

```
WaitLoad [\UnloadPath] [\UnloadFile] LoadNo [\CheckRef]
```

[\UnloadPath]

Data type: string

The file path and the file name to the file that will be unloaded from the program memory. The file name should be excluded when the argument \UnloadFile is used.

[\UnloadFile]

Data type: string

When the file name is excluded in the argument \UnloadPath, then it must be defined with this argument.

Continues on next page

1 Instructions

1.340 WaitLoad - Connect the loaded module to the task

RobotWare Base

Continued

LoadNo

Data type: loadsession

This is a reference to the load session, created by the instruction StartLoad that is needed to connect the loaded program module to the program task.

[\CheckRef]

Data type: switch

Check after loading of the module for unsolved references in the program task. If not used no check for unsolved references are done.

Program execution

The instruction WaitLoad will first wait for the loading to be completed, if it is not already done, and then the module will be linked and initialized. The initiation of the loaded module sets all variables at module level to their initial values.

Unresolved references will always be accepted for the loading operations StartLoad - WaitLoad if parameter \CheckRef is not used, but it will be a run time error on execution of an unresolved reference.

The system starts with the unloading operation, if specified. If the unloading of the module fails, then no new module will be loaded.

If any error from the loading operation, including unresolved references if use of switch \CheckRef, the loaded module will not be available any more in the program memory.

To obtain a good program structure, that is easy to understand and maintain, all loading and unloading of program modules should be done from the main module, which is always present in the program memory during execution.

For loading a program that contains a main procedure to a main program (with another main procedure), see instruction Load.



Note

Be aware of that Load, UnLoad, and WaitLoad can affect both the motion execution and other RAPID execution and shall therefore be called with caution.

Error handling

The following recoverable errors are generated and can be handled in an error handler. The system variable ERRNO will be set to:

Name	Cause of error
ERR_FILNOTFND	The file specified in the StartLoad instruction cannot be found.
ERR_IOERROR	Some type of problem to read the file to load.
ERR_UNKPROC	Argument LoadNo refers to an unknown load session.
ERR_PRGMEMFULL	The module cannot be loaded because the program memory is full.
ERR_LOADED	The program module is already loaded into the program memory.

Continues on next page

1.340 WaitLoad - Connect the loaded module to the task

RobotWare Base

Continued

Name	Cause of error
ERR_SYNTAX	The loaded module contains syntax errors.
ERR_LINKREF	The loaded module result in fatal link errors. <ul style="list-style-type: none"> The loaded module result in fatal link errors. WaitLoad is used with the switch \CheckRef to check for any reference error and the program memory contains unresolved references.

The following errors can only occur when the argument \UnloadPath is used in the instruction WaitLoad:

Name	Cause of error
ERR_UNLOAD	<ul style="list-style-type: none"> The module specified in the argument \UnloadPath cannot be unloaded because of ongoing execution within the module The module specified in the argument \UnloadPath cannot be unloaded because the program module is not loaded with Load or StartLoad-WaitLoad from the RAPID program.

If some of these error occurs, the actual module will be unloaded and will not be available in the ERROR handler.

More examples

More examples of the instruction WaitLoad are illustrated below.

Example 1

```
StartLoad "HOME:/DOORDIR/DOOR2.MOD", load1;
...
WaitLoad \UnloadPath:="HOME:/DOORDIR/DOOR1.MOD", load1;
```

Load the program module DOOR2.MOD from HOME: in the directory DOORDIR into the program memory and connect the new module to the task. The program module DOOR1.MOD will be unloaded from the program memory.

Example 2

```
StartLoad "HOME:" \File:="DOORDIR/DOOR2.MOD", load1;
! The robot can do some other work
WaitLoad \UnloadPath:="HOME:" \File:="DOORDIR/DOOR1.MOD", load1;
```

It is the same as the instructions below but the robot can do some other work during the loading time and also do it faster (only one link instead of the two links below).

```
Load "HOME:" \File:="DOORDIR/DOOR2.MOD";
Unload "HOME:" \File:="DOORDIR/DOOR1.MOD";
```



Note

RETRY cannot be used for error recovery for any errors from WaitLoad.

Limitations

It is not possible to change the current value of some PERS variable by loading the same module with a new init value for the actual PERS variable.

Continues on next page

1 Instructions

1.340 WaitLoad - Connect the loaded module to the task

RobotWare Base

Continued

Example:

- File `my_module.mod` with declaration `PERS num my_pers:=1;` is loaded in the system.
- The file `my_module.mod` is edited on disk with new persistent value eg. `PERS num my_pers:=3;`
- The code below is executed.
- After loading the `my_module.mod` again, the value of `my_pers` is still 1 instead of 3.

```
StartLoad \Dynamic, "HOME:/my_module.mod", load1;  
...  
WaitLoad \UnloadPath:="HOME:/my_module.mod", load1;
```

This limitation is a consequence of `PERS` variable characteristic. The current value of the `PERS` variable will not be changed by the new loaded `PERS` init value if the `PERS` variable is in any use at the loading time.

The above problems will not occur if the following code is executed instead:

```
Unload "HOME:/my_module.mod";  
StartLoad \Dynamic, "HOME:/my_module.mod", load1;  
...  
WaitLoad load1;
```

Another option is to use a `CONST` for the init value and do the following assignment in the beginning of the execution in the new module: `my_pers := my_const;`

Syntax

WaitLoad

```
[ '\ UnloadPath ':= ' <expression (IN) of string> ', ' ]  
[ '\ UnloadFile ':= ' <expression (IN) of string> ', ' ]  
[ LoadNo ':= ' ] <variable (VAR) of loadsession>  
[ '\ CheckRef ] ';' ]
```

Related information

For information about	See
Load a program module during execution	StartLoad - Load a program module during execution on page 787
Load session	loadsession - Program load session on page 1689
Load a program module	Load - Load a program module during execution on page 342
Unload a program module	Unload - Unload a program module during execution on page 1010
Cancel loading of a program module	CancelLoad - Cancel loading of a module on page 78
Check program references	CheckProgRef - Check program references on page 130
Procedure call with Late binding	Technical reference manual - RAPID Overview

1.341 WaitRob - Wait until stop point or zero speed

Usage

WaitRob (*Wait Robot*) waits until the robot and external axes have reached stop point or have zero speed.

Basic examples

The following example illustrates the instruction WaitRob:

See also [More examples on page 1065](#).

Example 1

```
WaitRob \InPos;
```

Program execution waits until the robot and external axes have reached stop point.

Arguments

```
WaitRob [\InPos] | [\ZeroSpeed]
```

[\InPos]

In Position

Data type: switch

If this argument is used then the robot and external axes must have reached the stop point (ToPoint of current move instruction) before the execution can continue.

This is not supported for conveyor tracking.

[\ZeroSpeed]

Zero Speed

Data type: switch

If this argument is used then the robot and external axes must have zero speed before the execution can continue.

If none of the arguments \InPos or \ZeroSpeed is entered, an error message will be displayed.

More examples

More examples of how to use the instruction WaitRob are illustrated below.

Example 1

```
PROC stop_event()
  WaitRob \ZeroSpeed;
  SetDO rob_moving, 0;
ENDPROC
```

The example shows an event routine that executes at program stop. The digital out signal rob_moving is 1 as long as the robot is moving and is set to 0 when the robot and external axes has stopped moving after a program stop.

Syntax

```
WaitRob
  [ '\ ' InPos ] | [ '\ ' ZeroSpeed ] ';' ;
```

Continues on next page

1 Instructions

1.341 WaitRob - Wait until stop point or zero speed

RobotWare Base

Continued

Related information

For information about	See
Motion in general	<i>Technical reference manual - RAPID Overview, section Motion and I/O principles</i>
Other positioning instructions	<i>Technical reference manual - RAPID Overview, section RAPID summary - Motion</i>
Definition of stop point data	stoppointdata - Stop point data on page 1755

1.342 WaitSensor - Wait for connection on sensor

Usage

WaitSensor connects to an object in the start window on the sensor mechanical unit.

Basic examples

Basic examples of the instruction WaitSensor are illustrated below.

See also [More examples on page 1068](#).

Example 1

```
WaitSensor Ssyncl;
```

The program connects to the first object in the object queue that is within the start window on the sensor. If there is no object in the start window then execution stops and waits for an object.

Arguments

```
WaitSensor MechUnit [\RelDist][\PredTime][\MaxTime][\TimeFlag]
```

MechUnit

Mechanical Unit

Data type: mecunit

The moving mechanical unit to which the robot position in the instruction is related.

[\RelDist]

Relative Distance

Data type: num

Waits for an object to enter the start window and go beyond the distance specified by the argument. If the work object is already connected, then execution stops until the object passes the given distance. If the object has already gone past the relative distance then execution continues.

[\PredTime]

Prediction Time

Data type: num

Waits for an object to enter the start window and go beyond the distance specified by the argument. If the work object is already connected, then execution stops until the object passes the given distance. If the object has already gone past the prediction time then execution continues.

[\MaxTime]

Maximum Time

Data type: num

The maximum period of waiting time permitted, expressed in seconds. If this time runs out before the sensor connection or \RelDist reached, the error handler will be called, if there is one, with the error code ERR_WAIT_MAXTIME. If there is no error handler, the execution will be stopped.

Continues on next page

1 Instructions

1.342 WaitSensor - Wait for connection on sensor

Machine Synchronization

Continued

[\TimeFlag]

Timeout Flag

Data type: bool

The output parameter that contains the value `TRUE` if the maximum permitted waiting time runs out before the sensor connection or `\RelDist` reached. If this parameter is included in the instruction, it is not considered to be an error if the max. time runs out.

This argument is ignored if the `MaxTime` argument is not included in the instruction.

Program execution

If there is no object in the start window then program execution stops. If an object is present, then the object is connected to the sensor and execution continues.

If a second `WaitSensor` instruction is issued while connected then an error is returned unless the `\RelDist` optional argument is used.

Error handling

If following errors occurs during execution of the `WaitSensor` instruction, the system variable `ERRNO` will be set. These errors can then be handled in the error handler.

Name	Cause of error
<code>ERR_CNV_NOT_ACT</code>	The sensor is not activated.
<code>ERR_CNV_CONNECT</code>	The <code>WaitSensor</code> instruction is already connected.
<code>ERR_CNV_DROPPED</code>	The object that the instruction <code>WaitSensor</code> was waiting for has been dropped by another task.
<code>ERR_WAIT_MAXTIME</code>	The object did not come in time and there is no <code>TimeFlag</code> .
<code>ERR_CNV_OBJ_LOST</code>	The object has passed the <code>StartwindowWidth</code> without being connected.

More examples

More examples of the instruction are illustrated below.

Example 1

```
WaitSensor Ssync1\RelDist:=500.0;
```

If not connected, then wait for the object to enter the start window and then wait for the object to pass the 500 mm point on the sensor.

If already connected to the object, then wait for the object to pass 500 mm.

Example 2

```
WaitSensor Ssync1\RelDist:=0.0;
```

If not connected, then wait for an object in the start window.

If already connected, then continue execution as the object has already gone past 0.0 mm.

Example 3

```
WaitSensor Ssync1;  
WaitSensor Ssync1\RelDist:=0.0;
```

Continues on next page

The first `WaitSensor` connects to the object in the start window. The second `WaitSensor` will return immediately if the object is still connected, but will wait for the next object if the previous object had moved past the maximum distance or was dropped.

Example 4

```
WaitSensor Ssync1\RelDist:=0.5\PredTime:=0.1;
```

The `WaitSensor` will return immediately if the object has passed 0.5 meter but otherwise will wait for an object will reach $=RelDist - C1speed * PredTime$. The goal here is to anticipate delays before starting a new move instruction.

Example 5

```
WaitSensor Ssync1\RelDist:=0.5\MaxTime:=0.1\TimeFlag:=flag1;
```

The `WaitSensor` will return immediately if the object has passed 0.5 meter but otherwise will wait 0.1 sec for an object. If no object passes 0.5 meter during this 0.1 sec the instruction will return with `flag1 = TRUE`.

Limitations

It requires 50 ms to connect to the first object in the start window. Once connected, a second `WaitSensor` with `\RelDist` optional argument will take only normal RAPID instruction execution time.

Syntax

```
WaitSensor
[ MechUnit ':' ] < variable (VAR) of mecunit >
[ '\ RelDist ':' ] < expression (IN) of num > ]
[ '\ PredTime ':' ] < expression (IN) of num > ]
[ '\ MaxTime ':' ] < expression (IN) of num > ]
[ '\ TimeFlag ':' ] < variable (VAR) of bool > ] ';'

```

Related information

For information about	See
Drop object on sensor	DropSensor - Drop object on sensor on page 188
Sync to sensor	SyncToSensor - Sync to sensor on page 854
Sync to sensor	SyncToSensor - Sync to sensor on page 854
Machine Synchronization	Application manual - Controller software IRC5

1 Instructions

1.343 WaitSyncTask - Wait at synchronization point for other program tasks

Multitasking

1.343 WaitSyncTask - Wait at synchronization point for other program tasks

Usage

`WaitSyncTask` is used to synchronize several program tasks at a special point in each program. Each program task waits until all program tasks have reach the named synchronization point.



Note

The instruction `WaitSyncTask` only synchronizes the program execution. To synchronize both the program execution and the robot movements, then the `Move` instruction before the `WaitSyncTask` must be a stop-point in all involved program tasks. It is also possible to synchronize both the program execution and the robot movements by using `WaitSyncTask \Inpos ...` in all involved program tasks.



WARNING

To reach safe synchronization functionality, the meeting point (parameter `SyncID`) must have an unique name in each program task. The name must also be the same for the program tasks that should meet in the meeting point.

Basic examples

The following examples illustrate the instruction `WaitSyncTask`:

See also [More examples on page 1072](#).

Example 1

Program example in task T_ROB1

```
PERS tasks task_list{2} := [ ["T_ROB1"], ["T_ROB2"] ];
VAR syncident sync1;

...
WaitSyncTask sync1, task_list;
...
```

Example 2

Program example in task T_ROB2

```
PERS tasks task_list{2} := [ ["T_ROB1"], ["T_ROB2"] ];
VAR syncident sync1;

...
WaitSyncTask sync1, task_list;
...
```

The program task, that first reaches `WaitSyncTask` with identity `sync1`, waits until the other program task reaches its `WaitSyncTask` with the same identity `sync1`. Then both program tasks `T_ROB1` and `T_ROB2` continue their execution.

Continues on next page

1.343 WaitSyncTask - Wait at synchronization point for other program tasks

Multitasking

Continued

Arguments

WaitSyncTask [`\InPos`] SyncID TaskList [`\TimeOut`]

[`\InPos`]

In Position

Data type: `switch`

If this argument is used then the robot and external axes must have come to a standstill before this program task starts waiting for other program tasks to reach its meeting point specified in the `WaitSyncTask` instruction.

SyncID

Synchronization identity

Data type: `syncident`

Variable that specifies the name of the synchronization (meeting) point. Data type `syncident` is a non-value type only used as an identifier for naming the synchronization point.

The variable must be defined and have an equal name in all cooperated program tasks. It is recommended to always define the variable global in each program task (`VAR syncident ...`).

TaskList

Data type: `tasks`

Persistent variable, that in a task list (array) specifies the name (`string`) of the program tasks, that should meet in the synchronization point with its name according to the argument `SyncID`.

The persistent variable must be defined and have an equal name and equal contents in all cooperated program tasks. It is recommended to always define the variable global in the system (`PERS tasks ...`).

[`\TimeOut`]

Data type: `num`

The max. time for waiting for the other program tasks to reach the synchronization point. Time-out in seconds (resolution 0.001s). If this argument is not specified then the program task will wait for ever.

If this time runs out before all program tasks have reached the synchronization point then the error handler will be called, if there is one, with the error code `ERR_WAITSYNCTASK`. If there is no error handler then the execution will be stopped.

Program execution

The actual program task will wait at `WaitSyncTask` until the other program tasks in the `TaskList` have reached the same `SyncID` point. At that time the respective program task will continue to execute its next instruction.

`WaitSyncTask` can be programmed between move instructions with corner zone in between. Depending on the timing balance between the program tasks at execution time, the system can:

- at best timing, keep all corner zones.

Continues on next page

1 Instructions

1.343 WaitSyncTask - Wait at synchronization point for other program tasks

Multitasking

Continued

- at worst timing, only keep the corner zone for the program task that reaches the `WaitSyncTask` last. For the other program tasks it will result in stop points.

It is possible to exclude program tasks for testing purposes from FlexPendant - Task Selection Panel.

The following principles can be used:

- Principle 1) Exclude the program task cycle-permanent from Task Selection Panel before starting from main (after set of `PP` to main) - This disconnection will be valid during the whole program cycle.
- Principle 2) Exclude the program task temporarily from the Task Selection Panel between some `WaitSyncTask` instructions in the program cycle - The system will only run the other connected tasks but will, with error message, force the user to connect the excluded program tasks before passing co-operated `WaitSyncTask`.
- Principle 3) If running according principle 2, it is possible to exclude some program task's permanent cycle from Task Selection Panel for further running according to principle 1 by executing the service routine `SkipTaskExec`.

Note that the Task Selection Panel is locked when running the system in synchronized movements.

Error handling

The following recoverable errors are generated and can be handled in an error handler. The system variable `ERRNO` will be set to:

Name	Cause of error
<code>ERR_WAITSYNCTASK</code>	A time-out occurs because <code>WaitSyncTask</code> not ready.

More examples

More examples of the instruction `WaitSyncTask` are illustrated below.

Example 1

Program example in task `T_ROB1`

```
PERS tasks task_list{2} := [ ["T_ROB1"], ["T_ROB2"] ];
VAR syncident sync1;

...
WaitSyncTask \InPos, sync1, task_list \TimeOut := 60;
...
ERROR
  IF ERRNO = ERR_WAITSYNCTASK THEN
    RETRY;
  ENDIF
```

The program task `T_ROB1` waits in instruction `WaitSyncTask` until its mechanical units are in position and after that it waits for the program task `T_ROB2` to reach its synchronization point with the same identity. After waiting for 60 s, the error handler is called with `ERRNO` equal to `ERR_WAITSYNCTASK`. Then the instruction `WaitSyncTask` is called again for an additional 60 s.

Continues on next page

1.343 WaitSyncTask - Wait at synchronization point for other program tasks

Multitasking

Continued

Limitation

If this instruction is preceded by a move instruction then that move instruction must be programmed with a stop point (zonedata *fine*), not a fly-by point. Otherwise restart after power failure will not be possible.

WaitSyncTask \InPos cannot be executed in a RAPID routine connected to any of the following special system events: PowerOn, Stop, QStop,Restart, or Step.

Syntax

```
WaitSyncTask
  [ '\ ' InPos ', ' ]
  [ SyncID ' := ' ] < variable (VAR) of syncident > ', '
  [ TaskList ' := ' ] < persistent array { * } (PERS) of tasks >
  [ '\ ' TimeOut ' := ' < expression (IN) of num > ] ' ; '
```

Related information

For information about	See
Specify cooperated program tasks	tasks - RAPID program tasks on page 1772
Identity for synchronization point	syncident - Identity for synchronization point on page 1768

1 Instructions

1.344 WaitTestAndSet - Wait until variable becomes FALSE, then set *RobotWare Base*

1.344 WaitTestAndSet - Wait until variable becomes FALSE, then set

Usage

`WaitTestAndSet` instruction waits for a specified `bool` persistent variable value to become `FALSE`. When the variable value becomes `FALSE`, the instruction will set value to `TRUE` and continue the execution. The persistent variable can be used as a binary semaphore for synchronization and mutual exclusion.

This instruction has the same underlying functionality as the `TestAndSet` function, but the `WaitTestAndSet` is waiting as long as the `bool` is `FALSE` while the `TestAndSet` instruction terminates immediately.

It is not recommended to use `WaitTestAndSet` instruction in a trap routine, UNDO handler, or event routines.

Examples of resources that can need protection from access at the same time:

- Use of some RAPID routines with function problems when executed in parallel.
- Use of the FlexPendant - Operator Log.

Basic examples

The following example illustrates the instruction `WaitTestAndSet`:

See also [More examples on page 1075](#).

Example 1

MAIN program task:

```
PERS bool tproutine_inuse := FALSE;
...
WaitTestAndSet tproutine_inuse;
TPWrite "First line from MAIN";
TPWrite "Second line from MAIN";
TPWrite "Third line from MAIN";
tproutine_inuse := FALSE;
```

BACK1 program task:

```
PERS bool tproutine_inuse := FALSE;
...
WaitTestAndSet tproutine_inuse;
TPWrite "First line from BACK1";
TPWrite "Second line from BACK1";
TPWrite "Third line from BACK1";
tproutine_inuse := FALSE;
```

To avoid mixing up the lines in the Operator Log (one from `MAIN` and one from `BACK1`) the use of the `WaitTestAndSet` function guarantees that all three lines from each task are not separated.

If program task `MAIN` takes the semaphore `WaitTestAndSet(tproutine_inuse)` first then program task `BACK1` must wait until the program task `MAIN` has left the semaphore.

Continues on next page

1.344 WaitTestAndSet - Wait until variable becomes FALSE, then set RobotWare Base Continued

Arguments

WaitTestAndSet Object

Object

Data type: bool

User defined data object to be used as semaphore. The data object must be a persistent variable PERS. If WaitTestAndSet are used between different program tasks then the object must be a global PERS.

Program execution

This instruction will in one indivisible step check and set the user defined persistent variable like code example below:

- if it has the value FALSE, set it to TRUE
- if it has the value TRUE, wait until it become FALSE and then set it to TRUE

```
IF Object = FALSE THEN
  Object := TRUE;
ELSE
  ! Wait until it become FALSE
  WaitUntil Object = FALSE;
  Object := TRUE;
ENDIF
```

After that the instruction is ready. To avoid problems, because persistent variables keep their value if program pointer PP is moved to main, always set the semaphore object to FALSE in the START event routine.

More examples

More examples of the instruction WaitTestAndSet are illustrated below.

Example 1

```
PERS bool semPers:= FALSE;
...
PROC doit(...)
  WaitTestAndSet semPers;
  ...
  semPers := FALSE;
ENDPROC
```



Note

If program execution is stopped in the routine `doit` and the program pointer is moved to `main` then the variable `semPers` will not be reset. To avoid this, reset the variable `semPers` to FALSE in the START event routine.

Syntax

```
WaitTestAndSet
[ Object '[:=' ] < persistent (PERS) of bool> ';
```

Continues on next page

1 Instructions

1.344 WaitTestAndSet - Wait until variable becomes FALSE, then set

RobotWare Base

Continued

Related information

For information about	See
Test variable and set if unset (type polled with WaitTime)	TestAndSet - Test variable and set if unset on page 1514

1.345 WaitTime - Waits a given amount of time

Usage

`WaitTime` is used to wait a given amount of time. This instruction can also be used to wait until the robot and external axes have come to a standstill.

Basic examples

The following example illustrates the instruction `WaitTime`:

See also [More examples on page 1077](#) below.

Example 1

```
WaitTime 0.5;
```

Program execution waits 0.5 seconds.

Arguments

```
WaitTime [\InPos] Time
```

[`\InPos`]

In Position

Data type: `switch`

If this argument is used then the robot and external axes must have come to a standstill before the waiting time starts to be counted. This argument can only be used if the task controls mechanical units.

Time

Data type: `num`

The time, expressed in seconds, that program execution is to wait. Min. value 0 s. Max. value no limit. Resolution 0.001 s.

Program execution

Program execution temporarily stops for the given amount of time. Interrupt handling and other similar functions, nevertheless, are still active.

In manual mode, after waiting more than 3 s, an alert box will pop up asking if the instruction should be simulated. It is possible to configure the alert to not appear, by setting the system parameter *SimulateMenu* to NO, see *Technical reference manual - System parameters*, topic *Controller*, type *General RAPID*.

More examples

More examples of how to use the instruction `WaitTime` are illustrated below.

Example 1

```
WaitTime \InPos,0;
```

Program execution waits until the robot and the external axes have come to a standstill.

Limitations

The argument `\InPos` cannot be used together with *SoftServo*.

Continues on next page

1 Instructions

1.345 WaitTime - Waits a given amount of time

RobotWare Base

Continued

If this instruction is preceded by a `Move` instruction then that `Move` instruction must be programmed with a stop point (zonedata fine), not a fly-by point. Otherwise it will not be possible to restart after a power failure.

`WaitTime \Inpos` cannot be executed in a RAPID routine connected to any of the following special system events: `PowerOn`, `Stop`, `QStop`, `Restart`, or `Step`.

Syntax

```
WaitTime
  ['\ ' InPos ',']
  [ Time ' := ' ] <expression (IN) of num> ';' ;'
```

Related information

For information about	See
Waiting until a condition is met	WaitUntil - Waits until a condition is met on page 1079
Waiting until an I/O is set/reset	WaitDI - Waits until a digital input signal is set on page 1033

1.346 WaitUntil - Waits until a condition is met

Usage

WaitUntil is used to wait until a logical condition is met; for example, it can wait until one or several inputs have been set.

Basic examples

The following example illustrates the instruction WaitUntil:

See also [More examples on page 1083](#).

Example 1

```
WaitUntil di4 = 1;
```

Program execution continues only after the di4 input has been set.

Arguments

```
WaitUntil [\InPos] Cond [\MaxTime] [\TimeFlag] [\PollRate]
[\Visualize] [\Header] [\Message] | [\MsgArray] [\Wrap]
[\Icon] [\Image] [\VisualizeTime] [\UIActiveSignal]
[\ErrorNumber] [\TimeOutSignal] [\TimeOutGOSignal]
[\TimeOutGOValue]
```

[\InPos]

In Position

Data type: switch

If this argument is used then the robot and external axes must have reached the stop point (ToPoint of current move instruction) before the execution can continue. This argument can only be used if the task controls mechanical units.

Cond

Data type: bool

The logical expression that is to be waited for.

[\MaxTime]

Data type: num

The maximum period of waiting time permitted, expressed in seconds. If this time runs out before the condition is set then the error handler will be called, if there is one, with the error code ERR_WAIT_MAXTIME. If there is no error handler then the execution will be stopped.

[\TimeFlag]

Timeout Flag

Data type: bool

The output parameter that contains the value TRUE if the maximum permitted waiting time runs out before the condition is met. If this parameter is included in the instruction then it is not considered to be an error if the max. time runs out. This argument is ignored if the MaxTime argument is not included in the instruction.

Continues on next page

1 Instructions

1.346 WaitUntil - Waits until a condition is met

RobotWare Base

Continued

[\PollRate]

Polling Rate

Data type: num

The polling rate in seconds for checking if the condition in argument `Cond` is `TRUE`. This means that `WaitUntil` first check the condition at once, and if not `TRUE`, then after the specified time until `TRUE`. Min. polling rate value 0.004 s. If this argument is not used then the default polling rate is set to 0.1 s.

[\Visualize]

Data type: switch

If selected, the visualization is activated. The visualization consists of a message box with the logical condition that is not fulfilled, icon, header, message lines, and image is displayed according to the programmed arguments.

[\Header]

Data type: string

Header text to be written at the top of the message box. Maximum 40 characters. If no `\Header` argument is used a default message will be displayed.

[\Message]

Data type: string

One text line to be written on the display. Maximum 50 characters.

[\MsgArray]

(Message Array)

Data type: string

Several text lines from an array to be written on the display. Only one of the parameters `\Message` or `\MsgArray` can be used at the same time.

Maximum layout space is 5 lines with 50 characters each.

[\Wrap]

Data type: switch

If selected, all the specified strings in the argument `\MsgArray` will be concatenated to one string with a single space between each individual string and spread out on as few lines as possible.

Default, each string in the argument `\MsgArray` will be on separate lines on the display.

[\Icon]

Data type: icondata

Defines the icon to be displayed. Only one of the predefined icons of type `icondata` can be used. See [Predefined data on page 1671](#).

Default, no icon.

[\Image]

Data type: string

Continues on next page

The name of the image that should be used. To launch your own images, the images have to be placed in the *HOME:* directory in the active system or directly in the active system.

The recommendation is to place the files in the *HOME:* directory so that they are saved if a backup and restore is done.

A restart is required and then the FlexPendant will load the images.

A demand on the system is that the RobotWare option *FlexPendant Interface* is used.

The image that will be shown can have the width of 185 pixels and the height of 300 pixels. If the image is larger, then only 185 * 300 pixels of the image will be shown starting at the top left of the image.

No exact value can be specified on the size that an image can have or the amount of images that can be loaded to the FlexPendant. It depends on the size of other files loaded to the FlexPendant. The program execution will just continue if an image is used that has not been loaded to the FlexPendant.

[`\VisualizeTime`]

Data type: num

The waiting time before the message box should appear on the FlexPendant. If using the arguments `\VisualizeTime` and `\MaxTime`, the time used in argument `\MaxTime` needs to be bigger than the time used in argument `\VisualizeTime`.

The default time for the visualization if not using the argument `\VisualizeTime` is 5 s. Minimum value 1 s. Maximum value no limit. Resolution 0.001 s.

[`\UIActiveSignal`]

Data type: signaldo

The digital output signal used in optional argument `UIActiveSignal` is set to 1 when the visualization message box is activated on the FlexPendant. When the message box is removed (when the condition is met), the signal is set to 0 again.

No supervision of stop or restart exist. The signal is set to 0 when the instruction is ready, or when PP is moved.

[`\ErrorNumber`]

Error number

Data type: errnum

A variable (before used it is set to 0 by the system) that will hold the error constant if the instruction ends before the signal has the desired value.

Continues on next page

1 Instructions

1.346 WaitUntil - Waits until a condition is met

RobotWare Base

Continued

If this optional variable is omitted then the error handler will be executed. The constants `ERR_GO_LIM`, `ERR_NO_ALIASIO_DEF`, `ERR_NORUNUNIT`, `ERR_SIG_NOT_VALID`, and `ERR_WAIT_MAXTIME` can be used to select the reason.



Note

If using signals in the `Cond` argument and you get any error when reading signal values, these errors must be handled in an error handler. It can not be handled with use of the `ErrorNumber` optional argument. The reason for this is that the condition is evaluated before entering the actual `WaitUntil` instruction.

`[\TimeOutSignal]`

Data type: `signaldo`

If `TimeOutSignal` is used, the signal is set to 0 when entering the `Wait` instruction. It is set to 1 if the instruction times out after waiting. The signal is also set to 0 when the program pointer is moved out from the `Wait` instruction.

This argument can only be used if the argument `MaxTime` is used.

`[\TimeOutGOSignal]`

Data type: `signalgo`

If `TimeOutGOSignal` is used, the signal is set to 0 when entering the `Wait` instruction. It is set to the value used in the argument `TimeOutGOValue` if the instruction times out after waiting. The signal is also set to 0 when the program pointer is moved out from the `Wait` instruction.

The optional arguments `TimeOutGOSignal` and `TimeOutGOValue` must be used together.

This argument can only be used if the argument `MaxTime` is used.

`[\TimeOutGOValue]`

Data type: `dnum`

The argument `TimeOutGOValue` holds the value that the signal in argument `TimeOutGOSignal` will be set to, if the instruction times out after waiting.

The optional arguments `TimeOutGOSignal` and `TimeOutGOValue` must be used together.

This argument can only be used if the argument `MaxTime` is used.

Program execution

If the programmed condition is not met on execution of a `WaitUntil` instruction then condition is checked again every 100 ms (or according value specified in argument `Pollrate`).

When the robot is waiting, the time is supervised. By default, the robot can wait forever, but the maximal waiting time can be specified with the optional argument `\MaxTime`. If this maximum time is exceeded, an error is raised.

In manual mode, after waiting more than 3 s, an alert box will pop up asking if the instruction should be simulated. It is possible to configure the alert to not appear,

Continues on next page

by setting the system parameter *SimulateMenu* to NO, see *Technical reference manual - System parameters*, topic *Controller*, type *General RAPID*.

If the switch `\Visualize` is used, a message box is displayed on the FlexPendant according to the programmed arguments. If no `\Header` argument is used a default header text will be displayed. When the execution of the `WaitUntil` instruction is ready, the message box will be removed from the FlexPendant.

New message box on trap level takes the focus from the message box on the basic level.

Error handling

The following recoverable errors are generated and can be handled in an error handler. The system variable `ERRNO` will be set to:

Name	Cause of error
<code>ERR_GO_LIM</code>	The programmed <code>TimeOutGOValue</code> argument for the specified digital group output signal <code>TimeOutGOSignal</code> is out of limit.
<code>ERR_NO_ALIASIO_DEF</code>	The signal variable is a variable declared in RAPID. It has not been connected to an I/O signal defined in the I/O configuration with instruction <code>AliasIO</code> .
<code>ERR_NORUNUNIT</code>	There is no contact with the I/O device.
<code>ERR_SIG_NOT_VALID</code>	The I/O signal cannot be accessed. The reasons can be that the I/O device is not running or an error in the configuration (only valid for ICI field bus).
<code>ERR_WAIT_MAXTIME</code>	There is a time-out (parameter <code>\MaxTime</code>) before the condition has changed to the right value.

More examples

More examples of how to use the instruction `WaitUntil` are illustrated below.

Example 1

```
VAR bool timeout;
WaitUntil start_input = 1 AND grip_status = 1 \MaxTime := 60
      \TimeFlag := timeout;
IF timeout THEN
  TPWrite "No start order received within expected time";
ELSE
  start_next_cycle;
ENDIF
```

If the two input conditions are not met within 60 seconds then an error message will be written on the display of the FlexPendant.

Example 2

```
WaitUntil \Inpos, di4 = 1;
```

Program execution waits until the robot has come to a standstill and the `di4` input has been set.

Example 3

```
WaitUntil di4 = 1 \MaxTime:=5.5;
..
```

Continues on next page

1 Instructions

1.346 WaitUntil - Waits until a condition is met

RobotWare Base

Continued

```
ERROR
  ERROR
    IF ERRNO = ERR_WAIT_MAXTIME THEN
      RAISE;
    ELSE
      Stop;
    ENDIF
```

Program execution waits until the di4 input has been set. If the I/O device has been disabled, or the waiting time expires, the execution continues in the error handler.

Example 4

```
WaitUntil di1 = 1 AND di2 = 1 \MaxTime := 60 \Visualize;
..
ERROR
  IF ERRNO = ERR_WAIT_MAXTIME THEN
    RAISE;
  ELSE
    Stop;
  ENDIF
```

If the two input conditions are not met within 5 seconds then a message will be written on the display of the FlexPendant. If the conditions is not met within 60 seconds the execution continues in the error handler.

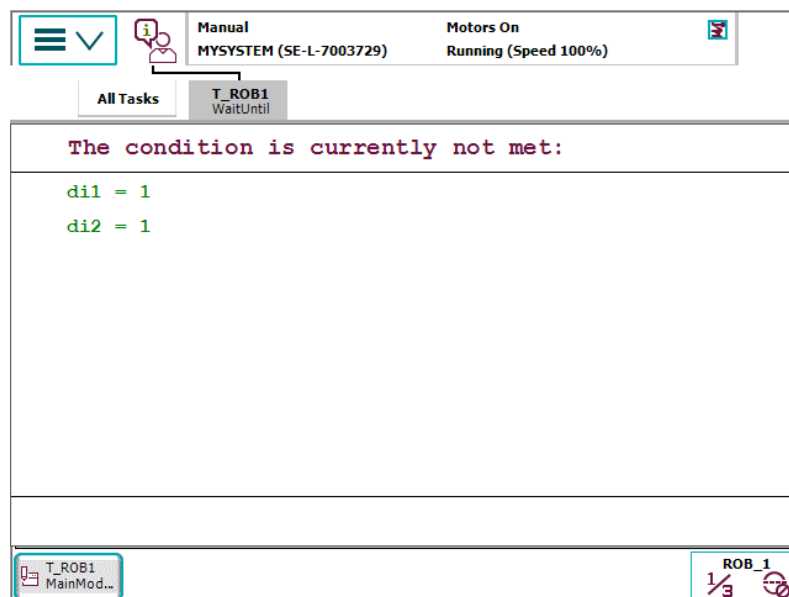

xx160000146

Example 5

```
WaitUntil di1 = 1 AND di2 = 1 \Visualize \Header:="Waiting for
  signals" \MsgArray:=["Movement will not start until",
    "conditions below are TRUE"] \Icon:=iconError;
MoveL p40, v500, z20, L10tip;
..
```

Continues on next page

If the two input conditions are not met then the header and message specified in the optional arguments `\Header` and `\MsgArray` will be written on the display of the FlexPendant together with the conditions that are not met.

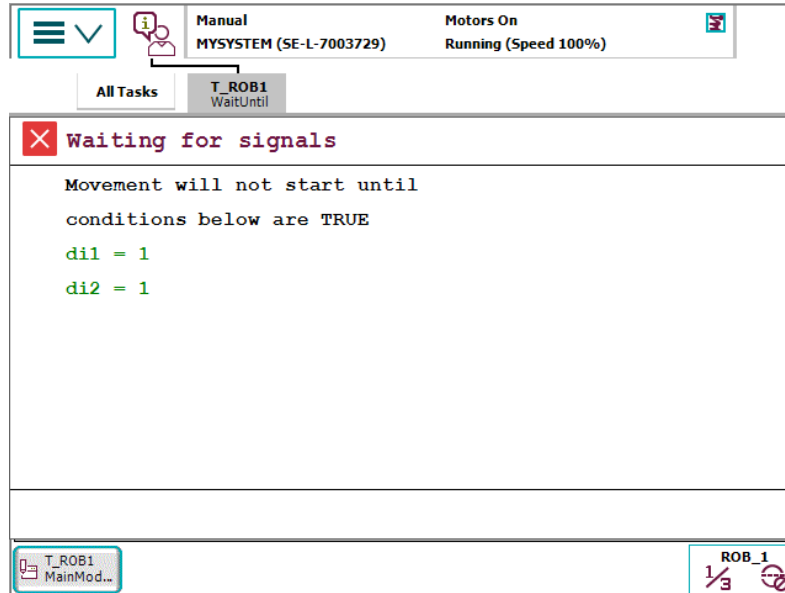

xx160000147

Example 6

```
VAR num reqValue:=1;
Waituntil diSignal = 1 OR diSignal = reqValue\Visualize;
```

If a variable is used in the condition with `\Visualize`, the variable, and not its value, will be displayed if the input conditions are not met.

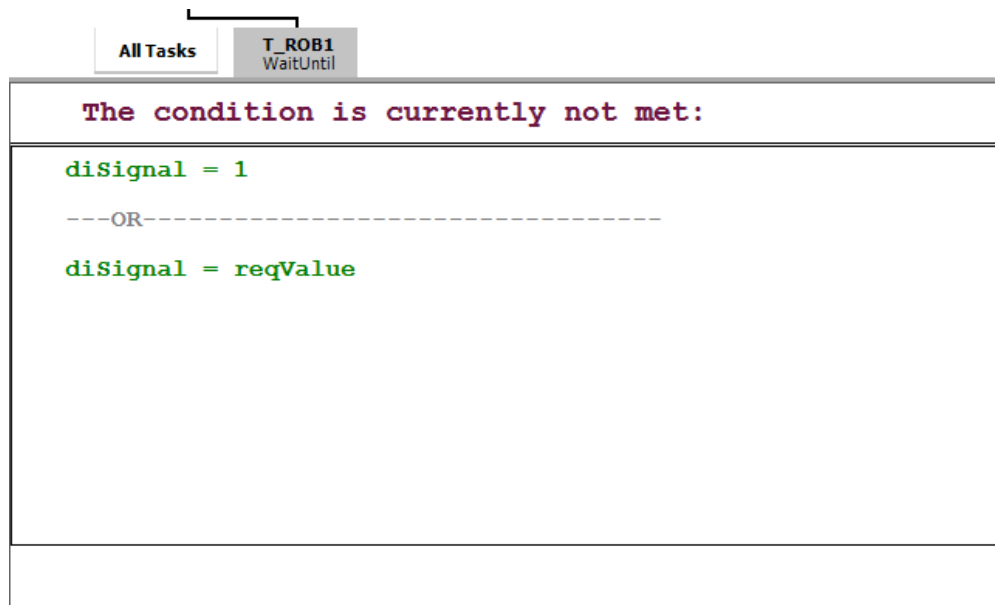

xx210000553

Limitation

The argument `\Inpos` cannot be used together with *SoftServo*.

Continues on next page

1 Instructions

1.346 WaitUntil - Waits until a condition is met

RobotWare Base

Continued

If this instruction is preceded by a `Move` instruction then that `Move` instruction must be programmed with a stop point (zonedata fine), not a fly-by point. Otherwise it will not be possible to restart after a power failure.

`WaitUntil \Inpos` cannot be executed in a RAPID routine connected to any of the following special system events: `PowerOn`, `Stop`, `QStop`, `Restart`, or `Step`.

`WaitUntil \Inpos` cannot be used together with `StopMove` to detect if the movement has been stopped. The `WaitUntil` instruction can be hanging forever in that case. It does not detect that the movement has stopped, it detects that the robot and external axes has reached the last programmed `ToPoint` (`MoveX`, `SearchX`, `TriggX`).

Syntax

```
WaitUntil
  ['\ ' InPos ',']
  [Cond ':' '=' ] <expression (IN) of bool>
  ['\ ' MaxTime ':' '=' <expression (IN) of num>]
  ['\ ' TimeFlag ':' '=' <variable (VAR) of bool>]
  ['\ ' PollRate ':' '=' <expression (IN) of num>]
  ['\ ' Visualize]
  ['\ ' Header ':' '=' <expression (IN) of string>]]
  ['\ ' Message ':' '=' <expression (IN) of string>]
  | ['\ ' MsgArray ':' '=' <array {*} (IN) of string>]
  ['\ ' Wrap]
  ['\ ' Icon ':' '=' <expression (IN) of icondata>]
  ['\ ' Image ':' '=' <expression (IN) of string>]
  ['\ ' VisualizeTime ':' '=' <expression (IN) of num>]
  ['\ ' UIActiveSignal ':' '=' <variable (VAR) of signaldo>]
  ['\ ' ErrorNumber ':' '=' <variable or persistent (INOUT) of errnum>]
  ['\ ' TimeOutSignal '=' <variable (VAR) of signaldo>]
  ['\ ' TimeOutGOSignal '=' <variable (VAR) of signalgo>]
  ['\ ' TimeOutGOValue '=' <expression (IN) of dnum>'];'
```

Related information

For information about	See
Waiting until an input is set/reset	WaitDI - Waits until a digital input signal is set on page 1033
Waiting a given amount of time	WaitTime - Waits a given amount of time on page 1077
Expressions	Technical reference manual - RAPID Overview

1.347 WaitWObj - Wait for work object on conveyor

Usage

WaitWObj (*Wait Work Object*) connects to a work object in the start window on the conveyor mechanical unit.

Basic examples

The following example illustrates the instruction WaitWObj:

See also [More examples on page 1088](#).

Example 1

```
WaitWObj wobj_on_cnv1;
```

The program connects to the first object in the object queue that is within the start window on the conveyor. If there is no object in the start window then execution waits for an object.

Arguments

```
WaitWObj WObj [ \RelDist ][\MaxTime][\TimeFlag]
```

WObj

Work Object

Data type: wobjdata

The moving work object (coordinate system) to which the robot position in the instruction is related. The mechanical unit conveyor is to be specified by the `ufmec` in the work object.

[\RelDist]

Relative Distance

Data type: num

Waits for an object to enter the start window and go beyond the distance specified by the argument. If the work object is already connected then execution waits until the object passes the given distance. If the object has already gone past the `\RelDist` then execution continues.

[\MaxTime]

Maximum Time

Data type: num

The maximum period of waiting time permitted, expressed in seconds. If this time runs out before the object connection or `\Reldist` reached then the error handler will be called, if there is one, with the error code `ERR_WAIT_MAXTIME`. If there is no error handler then the execution will be stopped.

[\TimeFlag]

Timeout Flag

Data type: bool

The output parameter that contains the value `TRUE` if the maximum permitted waiting time runs out before the object connection or `\Reldist` is reached. If this

Continues on next page

1 Instructions

1.347 WaitWObj - Wait for work object on conveyor

Conveyor Tracking

Continued

parameter is included in the instruction then it is not considered to be an error if the max. time runs out. This argument is ignored if the `MaxTime` argument is not included in the instruction.

Program execution

If there is no object in the start window then program execution waits. If an object is present then the work object is connected to the conveyor and execution continues.

If a second `WaitWObj` instruction is issued while connected then an error is returned unless the `\RelDist` optional argument is used.

Error handling

If the following errors occur during execution of the `WaitWObj` instruction then the system variable `ERRNO` will be set. These errors can then be handled in the error handler.

Name	Cause of error
<code>ERR_CNV_NOT_ACT</code>	The conveyor is not activated.
<code>ERR_CNV_CONNECT</code>	The <code>WaitWObj</code> instruction is already connected.
<code>ERR_CNV_DROPPED</code>	The object that the instruction <code>WaitWObj</code> was waiting for has been dropped by another task.
<code>ERR_WAIT_MAXTIME</code>	The object did not come in time and there is no <code>Timeflag</code> .
<code>ERR_CNV_OBJ_LOST</code>	The object has passed the <code>StartwindowWidth</code> without being connected.

More examples

More examples of the instruction `WaitWObj` are illustrated below.

Example 1

```
WaitWObj wobj_on_cnv1\RelDist:=500.0;
```

If not connected then wait for the object to enter the start window and then wait for the object to pass the 500 mm point on the conveyor.

If already connected to the object then wait for the object to pass 500 mm.

If not connected then wait for an object in the start window.

Example 2

```
WaitWObj wobj_on_cnv1\RelDist:=0.0;
```

If already connected then continue execution as the object has already gone past 0.0 mm.

Example 3

```
WaitWObj wobj_on_cnv1;  
WaitWObj wobj_on_cnv1\RelDist:=0.0;
```

The first `WaitWObj` connects to the object in the start window. The second `WaitWObj` will return immediately if the object is still connected. But it will wait for the next object if the previous object had moved past the maximum distance or was dropped.

Continues on next page

1.347 WaitWObj - Wait for work object on conveyor

Conveyor Tracking

Continued

Example 4

```
WaitWObj wobj_on_cnv1\RelDist:=500.0\MaxTime:=0.1 \Timeflag:=flag1;
```

The WaitWObj will return immediately if the object has passed 500 mm but otherwise will wait 0.1 sec for an object. If no object passes 500 mm during this 0.1 sec the instruction will return with flag1 =TRUE.

Limitations

It requires 50 ms to connect to the first object in the start window. Once connected, a second WaitWObj with \RelDist optional argument will take only normal RAPID instruction execution time.

Syntax

```
WaitWObj
[ WObj ':=' ] < persistent (PERS) of wobjdata> ';'
[ '\ ' RelDist ':=' < expression (IN) of num > ]
[ '\ ' MaxTime ':=' <expression (IN) of num>]
[ '\ ' TimeFlag ':=' <variable (VAR) of bool>] ';'

```

Related information

For information about	See
Drop workobject on conveyor	DropWObj - Drop work object on conveyor on page 189
Conveyor tracking	<i>Application manual - Conveyor tracking</i>

1 Instructions

1.348 WarmStart - Restart the controller

RobotWare Base

1.348 WarmStart - Restart the controller

Usage

`WarmStart` is used to restart the controller.

The system parameters can be changed from RAPID with the instruction `WriteCfgData`. You must restart the controller in order for a change to have effect on some of the system parameters. The restart can be done with this instruction `WarmStart`.

Basic examples

The following example illustrates the instruction `WarmStart`:

Example 1

```
WriteCfgData "/MOC/MOTOR_CALIB/rob1_1", "cal_offset", offset1;  
WarmStart;
```

Writes the value of the `num` variable `offset1` as calibration offset for axis 1 on `rob1` and generates a restart of the controller.

Program execution

`Warmstart` takes effect at once and the program pointer is set to the next instruction.

Syntax

```
WarmStart ';' ;
```

Related information

For information about	See
Write attribute of a system parameter	WriteCfgData - Writes attribute of a system parameter on page 1104
Configuration	<i>Technical reference manual - System parameters</i>
<i>Advanced RAPID</i>	<i>Product specification - Controller software IRC5</i>

1.349 WHILE - Repeats as long as ...

Usage

WHILE is used when a number of instructions are to be repeated as long as a given condition expression evaluates to a **TRUE** value.



Tip

If it is possible to determine the number of repetitions then the **FOR** instruction can be used.

Basic examples

The following example illustrates the instruction **WHILE**:

Example 1

```
WHILE reg1 < reg2 DO
  ...
  reg1 := reg1 + 1;
ENDWHILE
```

Repeats the instructions in the **WHILE**-block as long as `reg1 < reg2`.

Arguments

```
WHILE Condition DO ... ENDWHILE
```

Condition

Data type: `bool`

The condition that must be evaluated to a **TRUE** value for the instructions in the **WHILE**-block to be executed.

Program execution

- 1 The condition expression is evaluated. If the expression evaluates to a **TRUE** value then the instructions in the **WHILE**-block are executed.
- 2 The condition expression is then evaluated again, and if the result of this evaluation is **TRUE** then the instructions in the **WHILE**-block are executed again.
- 3 This process continues until the result of the expression evaluation becomes **FALSE**.
- 4 If a **Break** is executed in the **WHILE** loop, the loop is interrupted and the execution continues after the **WHILE** loop.
- 5 If a **Continue** is executed in the **WHILE** loop, the rest of the statements in the loop are disregarded, and the execution continues in the beginning of the **WHILE** loop.

The iteration is then terminated and the program execution continues from the instruction after the **WHILE**-block.

Continues on next page

1 Instructions

1.349 WHILE - Repeats as long as ...

RobotWare Base

Continued

If the result of the expression evaluation is `FALSE` at the very outset then the instructions in the `WHILE`-block are not executed at all, and the program control transfers immediately to the instruction that follows after the `WHILE`-block.

Syntax

```
WHILE <conditional expression> DO
  <statement list>
ENDWHILE
```

Related information

For information about	See
Expressions	<i>Technical reference manual - RAPID Overview, section Basic characteristics - Expressions</i>
Repeats a given number of times	FOR - Repeats a given number of times on page 220

1.350 WorldAccLim - Control acceleration in world coordinate system

Usage

`WorldAccLim` (*World Acceleration Limitation*) is used to limit the acceleration/deceleration of the tool (and payload) in the world coordinate system. The limitation will be achieved all together in the gravity center point of the actual tool, actual payload (if present), and the mounting flange of the robot. This instruction can only be used in the main task `T_ROB1` or, if in a *MultiMove* system, in Motion tasks.

Basic examples

The following examples illustrate the instruction `WorldAccLim`:

Example 1

```
WorldAccLim \On := 3.5;
```

Acceleration/deceleration is limited to 3.5 m/s².

Example 2

```
WorldAccLim \Off;
```

The acceleration/deceleration is reset to maximum (default).

Arguments

```
WorldAccLim [\On] | [\Off]
```

`[\On]`

Data type: num

The absolute value of the acceleration/deceleration limitation in m/s².

`[\Off]`

Data type: switch

No limit. Maximum acceleration (default).

Program execution

The acceleration limitations applies for the next executed robot movement instruction and is valid until a new `WorldAccLim` instruction is executed.

The maximum acceleration (`WorldAccLim \Off`) is automatically set

- when using the restart mode **Reset RAPID**
- when loading a new program or a new module
- when starting program execution from the beginning
- when moving the program pointer to `main`
- when moving the program pointer to a routine
- when moving the program pointer in such a way that the execution order is lost.

Continues on next page

1 Instructions

1.350 WorldAccLim - Control acceleration in world coordinate system

RobotWare Base

Continued

It is recommended to use just one type of limitation of the acceleration. If a combination of instructions `WorldAccLim`, `AccSet`, and `PathAccLim` are done then the system reduces the acceleration/deceleration in the following order:

- according `WorldAccLim`
- according `AccSet`
- according `PathAccLim`

Error handling

The following recoverable errors are generated and can be handled in an error handler. The system variable `ERRNO` will be set to:

Name	Cause of error
<code>ERR_ACC_TOO_LOW</code>	The argument <code>On</code> is set to a value that is too low.

Limitations

The minimum acceleration allowed is 0.1 m/s^2 .

The following robot models are not supported and cannot use the `WorldAccLim` instruction:

- IRB 340, IRB 360, IRB 540, IRB 1400, IRB 1410

Syntax

```
WorldAccLim  
[ '\ On ' := ' <expression (IN) of num> ' | [ '\ Off ' ] ';' ]
```

Related information

For information about	See
Positioning instructions	Technical reference manual - RAPID Overview
Motion settings data	motsetdata - Motion settings data on page 1692
Reduction of acceleration	AccSet - Reduces the acceleration on page 25
Limitation of acceleration along the path	PathAccLim - Reduce TCP acceleration along the path on page 512

1.351 Write - Writes to a character-based file or I/O device

Usage

`Write` is used to write to a character-based file or I/O device. The value of certain data can be written as well as text.

Basic examples

The following examples illustrate the instruction `Write`:

Example 1

```
Write logfile, "Execution started";
```

The text `Execution started` is written to the file with reference name `logfile`.

Example 2

```
VAR num reg1:=5;
```

```
...
```

```
Write logfile, "No of produced parts="\Num:=reg1;
```

The text `No of produced parts=5`, is written to the file with the reference name `logfile`.

Arguments

```
Write IODevice String [\Num] | [\Bool] | [\Pos] | [\Orient] |  
[\Dnum] [\NoNewLine]
```

IODevice

Data type: `iodev`

The name (reference) of the current file or I/O device.

String

Data type: `string`

The text to be written.

[\Num]

Numeric

Data type: `num`

The data whose numeric values are to be written after the text string.

[\Bool]

Boolean

Data type: `bool`

The data whose logical values are to be written after the text string.

[\Pos]

Position

Data type: `pos`

The data whose position is to be written after the text string.

[\Orient]

Orientation

Continues on next page

1 Instructions

1.351 Write - Writes to a character-based file or I/O device

RobotWare Base

Continued

Data type: orient

The data whose orientation is to be written after the text string.

[\Dnum]

Numeric

Data type: dnum

The data whose numeric values are to be written after the text string.

[\NoNewLine]

Data type: switch

Omits the line-feed character that normally indicates the end of the text, i.e. next write instruction will continue on the same line.

Program execution

The text string is written to a specified file or I/O device. A line-feed character (LF) is also written, but can be omitted if the argument \NoNewLine is used.

If one of the arguments \Num, \Bool, \Pos, or \Orient is used then its value is first converted to a text string before being added to the first string. The conversion from value to text string takes place as follows:

Argument	Value	Text string
\Num	23	"23"
\Num	1.141367	"1.14137"
\Bool	TRUE	"TRUE"
\Pos	[1817.3,905.17,879.11]	"[1817.3,905.17,879.11]"
\Orient	[0.96593,0,0.25882,0]	"[0.96593,0,0.25882,0]"
\Dnum	4294967295	"4294967295"

The value is converted to a string with standard RAPID format. This means in principle 6 significant digits. If the decimal part is less than 0.000005 or greater than 0.999995, the number is rounded to an integer.

At power fail restart, any open file or I/O device in the system will be closed and the I/O descriptor in the variable of type iODEV will be reset.

Error handling

The following recoverable errors are generated and can be handled in an error handler. The system variable ERRNO will be set to:

Name	Cause of error
ERR_FILEACC	An error occurs during writing.

Limitations

The arguments \Num, \Dnum, \Bool, \Pos, and \Orient are mutually exclusive and thus cannot be used simultaneously in the same instruction.

This instruction can only be used for files or I/O devices that have been opened for writing.

Continues on next page

Syntax

```

Write
  [ IODevice '[:]=' <variable (VAR) of iodev> ', '
  [ String '[:]=' <expression (IN) of string>
  [ '\ Num '[:]=' <expression (IN) of num> ]
  | ['\ Bool '[:]=' <expression (IN) of bool> ]
  | ['\ Pos '[:]=' <expression (IN) of pos> ]
  | ['\ Orient '[:]=' <expression (IN) of orient> ]
  | ['\ Dnum '[:]=' <expression (IN) of dnum> ]
  [ '\ NoNewLine ] ';'

```

Related information

For information about	See
Opening a file or I/O device	<i>Technical reference manual - RAPID Overview</i>
File and I/O device handling	<i>Application manual - Controller software IRC5</i>

1 Instructions

1.352 WriteAnyBin - Writes data to a binary file or I/O device

RobotWare Base

1.352 WriteAnyBin - Writes data to a binary file or I/O device

Usage

`WriteAnyBin` (*Write Any Binary*) is used to write any type of data to a binary file or I/O device.

Basic examples

The following example illustrates the instruction `WriteAnyBin`:

Example 1

```
VAR iodev file1;  
VAR orient quat1 := [1, 0, 0, 0];  
...  
Open "HOME:" \File:= "FILE1.DOC", file1 \Bin;  
WriteAnyBin file1, quat1;
```

The orient data `quat1` is written to the channel referred to by `channell`.

Arguments

`WriteAnyBin` IODevice Data

IODevice

Data type: `iodev`

The name (reference) of the binary file or I/O device for the writing operation.

Data

Data type: `anytype`

Data to be written.

Program execution

As many bytes as required for the specified data are written to the specified binary file or I/O device.

At power fail restart, any open file or I/O device in the system will be closed and the I/O descriptor in the variable of type `iodev` will be reset.

Error handling

The following recoverable errors are generated and can be handled in an error handler. The system variable `ERRNO` will be set to:

Name	Cause of error
<code>ERR_FILEACC</code>	An error occurs during writing.

Limitations

This instruction can only be used for files or I/O devices that have been opened for binary writing.

The data to be written by this instruction `WriteAnyBin` must be value data type such as `num`, `bool`, or `string`. Record, record component, array, or array element of these value data types can also be used. Entire data or partial data with semi-value or non-value data types cannot be used.

Continues on next page

1.352 WriteAnyBin - Writes data to a binary file or I/O device

RobotWare Base

Continued

Because WriteAnyBin-ReadAnyBin is designed to only send internal controller data between robot controllers, no data protocol is released and the data cannot be interpreted on any PC.

**Note**

Control software development can break the compatibility, and therefore it might not be possible to use WriteAnyBin-ReadAnyBin between different software versions of RobotWare.

Syntax

```
WriteAnyBin
  [ IODevice ':='] <variable (VAR) of iodev> ','
  [ Data ':='] <expression (IN) of anytype> ';'

```

Related information

For information about	See
Opening of I/O devices or files	<i>Technical reference manual - RAPID Overview</i>
Read data from a binary I/O device or file	ReadAnyBin - Read data from a binary I/O device or file on page 582
File and I/O device handling	<i>Application manual - Controller software IRC5</i>

1 Instructions

1.353 WriteBin - Writes to a binary I/O device
RobotWare Base

1.353 WriteBin - Writes to a binary I/O device

Usage

`WriteBin` is used to write a number of bytes to a binary I/O device.

Basic examples

The following example illustrates the instruction `WriteBin`:

Example 1

```
WriteBin channel2, text_buffer, 10;
```

10 characters from the `text_buffer` list are written to the channel referred to by `channel2`.

Arguments

```
WriteBin IODevice Buffer NChar
```

IODevice

Data type: `iodev`
Name (reference) of the current I/O device.

Buffer

Data type: array of `num`
The list (array) containing the numbers (characters) to be written.

NChar

Number of Characters
Data type: `num`
The number of characters to be written from the `Buffer`.

Program execution

The specified number of numbers (characters) in the list is written to the I/O device. At power fail restart, any open file or I/O device in the system will be closed and the I/O descriptor in the variable of type `iodev` will be reset.

Error handling

The following recoverable errors are generated and can be handled in an error handler. The system variable `ERRNO` will be set to:

Name	Cause of error
<code>ERR_FILEACC</code>	An error occurs during writing.

Limitations

This instruction can only be used for I/O devices that have been opened for binary writing.

Syntax

```
WriteBin  
[ IODevice '[:=' ] <variable (VAR) of iodev> ','
```

Continues on next page

```
[ Buffer ':='] <array {*} (IN) of num> ','  
[ NChar ':='] <expression (IN) of num> ';' 
```

Related information

For information about	See
Opening, etc. of I/O devices	<i>Technical reference manual - RAPID Overview</i>
Convert a string to a byte data	StrToByte - Converts a string to a byte data on page 1500
Byte data	byte - Integer values 0-255 on page 1606
File and I/O device handling	<i>Application manual - Controller software IRC5</i>

1 Instructions

1.354 WriteBlock - Write block of data to device

Sensor Interface

1.354 WriteBlock - Write block of data to device

Usage

`WriteBlock` is used to write a block of data to a device connected to the serial sensor interface. The data is fetched from a file.

The sensor interface communicates with sensors over serial channels using the RTP1 transport protocol.

This is an example of a sensor channel configuration.

```
COM_PHY_CHANNEL:
  Name "COM1:"
  Connector "COM1"
  Baudrate 19200
COM_TRP:
  Name "sen1:"
  Type "RTP1"
  PhyChannel "COM1"
```

Basic examples

The following example illustrates the instruction `WriteBlock`:

Example 1

```
CONST string SensorPar := "flp1:senpar.cfg";
CONST num ParBlock:= 1;

! Connect to the sensor device "sen1:" (defined in sio.cfg).
SenDevice "sen1:";

! Write sensor parameters from flp1:senpar.cfg
! to sensor datablock 1.

WriteBlock "sen1:", ParBlock, SensorPar;
```

Arguments

```
WriteBlock device BlockNo FileName [ \TaskName ]
```

device

Data type: string

The I/O device name configured in `sio.cfg` for the sensor used.

BlockNo

Data type: num

The argument `BlockNo` is used to select the data block in the sensor block to be written.

FileName

Data type: string

The argument `FileName` is used to select a file from which data is written to the data block in the sensor selected by the `BlockNo` argument.

Continues on next page

[\TaskName]

Data type: string

The argument `TaskName` makes it possible to access devices in other RAPID tasks.

Error handling

The following recoverable errors are generated and can be handled in an error handler. The system variable `ERRNO` will be set to:

Error constant (ERRNO value)	Description
SEN_NO_MEAS	Measurement failure
SEN_NOREADY	Sensor unable to handle command
SEN_GENERRO	General sensor error
SEN_BUSY	Sensor bus
SEN_UNKNOWN	Unknown sensor
SEN_EXALARM	External sensor error
SEN_CAALARM	Internal sensor error
SEN_TEMP	Sensor temperature error
SEN_VALUE	Illegal communication value
SEN_CAMCHECK	Sensor check failure
SEN_TIMEOUT	Communication error

Syntax

```
WriteBlock
  [ device ':= ' ] < expression (IN) of string > ', '
  [ BlockNo ':= ' ] < expression (IN) of num > ', '
  [ FileName ':= ' ] < expression (IN) of string > ', '
  [ '\ ' TaskName ':= ' < expression (IN) of string > ] ';'

```

Related information

For information about	See
Connect to a sensor device	SenDevice - connect to a sensor device on page 688
Write a sensor variable	WriteVar - Write variable on page 1112
Read a sensor data block	ReadBlock - read a block of data from device on page 584
Configuration of sensor communication	<i>Technical reference manual - System parameters</i>

1 Instructions

1.355 WriteCfgData - Writes attribute of a system parameter

RobotWare Base

1.355 WriteCfgData - Writes attribute of a system parameter

Usage

`WriteCfgData` is used to write one attribute of a system parameter (configuration data).

Besides writing named parameters, it is also possible to search and update unnamed parameters

Basic examples

The following examples illustrate the instruction `WriteCfgData`. Both of these examples show how to write named parameter data.

Example 1

```
VAR num offset1 := 1.2;
...
WriteCfgData "/MOC/MOTOR_CALIB/rob1_1", "cal_offset", offset1;
```

Written in the `num` variable `offset1`, the calibration offset for axis 1 on `rob_1`.

Example 2

```
VAR string io_device := "my_device";
...
WriteCfgData "/EIO/EIO_SIGNAL/process_error", "Device", io_device;
```

Written in the `string` variable `io_device`, the name of the I/O device where the signal `process_error` is defined.

Arguments

```
WriteCfgData InstancePath Attribute CfgData [\ListNo]
```

InstancePath

Data type: `string`

Specifies the path to the parameter to be accessed.

For named parameters, the format of this string is `/DOMAIN/TYPE/ParameterName`.

For unnamed parameters, the format of this string is

`/DOMAIN/TYPE/Attribute/AttributeValue`.

Attribute

Data type: `string`

The name of the attribute of the parameter to be written.

CfgData

Data type: `anytype`

The data object from which the new data to store is read. Depending on the attribute type, valid types are `bool`, `num`, `dnum`, or `string`.

[\ListNo]

Data type: `num`

Variable holding the instance number of the `Attribute + AttributeValue` to be found and updated.

Continues on next page

First occurrence of the `Attribute + AttributeValue` has instance number 0. If there are more instances to search for then the returned value in `\ListNo` will be incremented with 1. Otherwise if there are no more instance then the returned value will be -1. The predefined constant `END_OF_LIST` can be used for check if there are more instances to search for.

Program execution

The value of the attribute specified by the `Attribute` argument is set according to the value of the data object specified by the `CfgData` argument.

If using format `/DOMAIN/TYPE/ParameterName` in `InstancePath` then only named parameters can be accessed, i.e. parameters where the first attribute is name, Name, or NAME.

For unnamed parameters, use the optional parameter `\ListNo` to specify which instance to write the attribute value to. It is updated after each successful write to the next available instance to write to.

Error handling

The following recoverable errors are generated and can be handled in an error handler. The system variable `ERRNO` will be set to:

Name	Cause of error
<code>ERR_CFG_NOTFND</code>	It is not possible to find the data specified with "InstancePath + Attribute" in the configuration database.
<code>ERR_CFG_ILLLTYPE</code>	The data type for parameter <code>CfgData</code> is not equal to the real data type for the found data specified with "InstancePath + Attribute" in the configuration database.
<code>ERR_CFG_LIMIT</code>	The data for parameter <code>CfgData</code> is outside limits (max./min. value).
<code>ERR_CFG_INTERNAL</code>	Trying to write internally written protected data.
<code>ERR_CFG_OUTOFBOUNDS</code>	Variable in argument <code>\ListNo</code> has a value outside range of available instances (0 ... n) when executing the instruction.

More examples

More examples of the instruction `WriteCfgdata` are illustrated below. Both of these examples show how to write to unnamed parameters.

Example 1

```
VAR num read_index;
VAR num write_index;
VAR string read_str;
...
read_index:=0;
write_index:=0;
ReadCfgData "/EIO/EIO_CROSS/Act1/do_13", "Res", read_str,
  \ListNo:=read_index;
WriteCfgData "/EIO/EIO_CROSS/Act1/do_13", "Res", "my"+read_str,
  \ListNo:=write_index;
```

Continues on next page

1 Instructions

1.355 WriteCfgData - Writes attribute of a system parameter

RobotWare Base

Continued

Reads the resultant signal for the unnamed digital actor signal `do_13` and places the name in the string variable `read_str`. Then update the name to `di_13` with prefix "my".

In this example, domain EIO has the following cfg code:

EIO_CROSS:

```
-Name "Cross_di_1_do_2" -Res "di_1" -Act1 "do_2"  
-Name "Cross_di_2_do_2" -Res "di_2" -Act1 "do_2"  
-Name "Cross_di_13_do_13" -Res "di_13" -Act1 "do_13"
```

Example 2

```
VAR num read_index;  
VAR num write_index;  
VAR string read_str;  
...  
read_index:=0;  
write_index:=0;  
WHILE read_index <> END_OF_LIST DO  
  ReadCfgData "/EIO/EIO_SIGNAL/Device/USERIO", "Name", read_str,  
  \ListNo:=read_index;  
  IF read_index <> END_OF_LIST THEN  
    WriteCfgData "/EIO/EIO_SIGNAL/Device/USERIO", "Name",  
    "my"+read_str, \ListNo:=write_index;  
  ENDIF  
ENDWHILE
```

Read the names of all signals defined for the I/O device `USERIO`. Change the names on the signals to the read name with the prefix "my".

In this example, domain EIO has the following cfg code:

```
EIO_SIGNAL:  
-Name "USERDO1" -SignalType "DO" -Device "USERIO" -DeviceMap "0"  
-Name "USERDO2" -SignalType "DO" -Device "USERIO" -DeviceMap "1"  
-Name "USERDO3" -SignalType "DO" -Device "USERIO" -DeviceMap "2"
```

Limitations

The conversion from RAPID program units (mm, degree, second etc.) to system parameter units (m, radian, second etc.) for `CfgData` of data type `num` and `dnum` must be done by the user in the RAPID program.

For most system parameters, you must manually restart the controller or execute the instruction `WarmStart` in order for the change to have effect. System parameters that can be changed from RobotStudio or FlexPendant without a restart does not require a restart when changed from RAPID either.

If using format `/DOMAIN/TYPE/ParameterName` in `InstancePath` then only named parameters can be accessed, i.e. parameters where the first attribute is `name`, `Name`, or `NAME`.

RAPID strings are limited to 80 characters. In some cases, this can be in theory too small for the definition of `InstancePath`, `Attribute`, or `CfgData`.

Continues on next page

Predefined data

The predefined constant `END_OF_LIST` with value -1 can be used to stop writing when no more instances can be found.

Syntax

```
WriteCfgData
  [ InstancePath ':' ] < expression (IN) of string > ','
  [ Attribute ':' ] < expression (IN) of string > ','
  [ CfgData ':' ] < expression (IN) of anytype >
  [ '\ ' ListNo ':' < variable (VAR) of num > ] ';'

```

Related information

For information about	See
Definition of string	string - Strings on page 1761
Read attribute of a system parameter	ReadCfgData - Reads attribute of a system parameter on page 586
Get robot name in current task	RobName - Get the TCP robot name on page 1447
Configuration	<i>Technical reference manual - System parameters</i>
Restart of the system	WarmStart - Restart the controller on page 1090
<i>Advanced RAPID</i>	<i>Product specification - Controller software IRC5</i>

1 Instructions

1.356 WriteRawBytes - Write rawbytes data

RobotWare Base

1.356 WriteRawBytes - Write rawbytes data

Usage

`WriteRawBytes` is used to write data of type `rawbytes` to a device opened with `Open\Bin`.

Basic examples

The following example illustrates the instruction `WriteRawBytes`:

Example 1

```
VAR iODEV io_device;
VAR rawbytes raw_data_out;
VAR rawbytes raw_data_in;
VAR num float := 0.2;
VAR string answer;

ClearRawBytes raw_data_out;
PackDNHeader "10", "20 1D 24 01 30 64", raw_data_out;
PackRawBytes float, raw_data_out, (RawBytesLen(raw_data_out)+1)
    \Float4;

Open "/FCI1:/dsqc328_1", io_device \Bin;
WriteRawBytes io_device, raw_data_out;
ReadRawBytes io_device, raw_data_in \Time:=1;
Close io_device;
UnpackRawBytes raw_data_in, 1, answer \ASCII:=10;
```

In this example `raw_data_out` is cleared and then packed with DeviceNet header and a float with value 0.2.

A device, `"/FCI1:/dsqc328_1"`, is opened and the current valid data in `raw_data_out` is written to the device. Then the program waits for at most 1 second to read from the device, which is stored in the `raw_data_in`.

After having closed the device `"/FCI1:/dsqc328_1"`, then the read data is unpacked as a string of 10 characters and stored in `answer`.

Arguments

```
WriteRawBytes IODevice RawData [\NoOfBytes]
```

`IODevice`

Data type: `iODEV`

`IODevice` is the identifier of the device to which `RawData` shall be written.

`RawData`

Data type: `rawbytes`

`RawData` is the data container to be written to `IODevice`.

`[\NoOfBytes]`

Data type: `num`

Continues on next page

`\NoOfBytes` tells how many bytes of `RawData` should be written to `IODevice`, starting at index 1.

If `\NoOfBytes` is not present then the current length of valid bytes in the variable `RawData` is written to device `IODevice`.

Program execution

During program execution, data is written to the device indicated by `IODevice`.

If using `WriteRawBytes` for field bus commands, such as `DeviceNet`, then the field bus always sends an answer. The answer must be handle in RAPID with the `ReadRawBytes` instruction.

The current length of valid bytes in the `RawData` variable is not changed.

At power fail restart, any open file or I/O device in the system will be closed and the I/O descriptor in the variable of type `iodev` will be reset.

Error handling

The following recoverable errors are generated and can be handled in an error handler. The system variable `ERRNO` will be set to:

Name	Cause of error
<code>ERR_FILEACC</code>	An error occurs during writing.

Syntax

```
WriteRawBytes
  [ IODevice ':= ' ] < variable (VAR) of iodev> ', '
  [ RawData ':= ' ] < variable (VAR) of rawbytes>
  [ '\ ' NoOfBytes ':= ' < expression (IN) of num> ] ';' ;'
```

Related information

For information about	See
rawbytes data	rawbytes - Raw data on page 1721
Get the length of rawbytes data	RawBytesLen - Get the length of rawbytes data on page 1422
Clear the contents of rawbytes data	ClearRawBytes - Clear the contents of rawbytes data on page 145
Copy the contents of rawbytes data	CopyRawBytes - Copy the contents of rawbytes data on page 169
Pack DeviceNet header into rawbytes data	PackDNHeader - Pack DeviceNet Header into rawbytes data on page 505
Pack data into rawbytes data	PackRawBytes - Pack data into rawbytes data on page 508
Read rawbytes data	ReadRawBytes - Read rawbytes data on page 593
Unpack data from rawbytes data	UnpackRawBytes - Unpack data from rawbytes data on page 1013
File and I/O device handling	Application manual - Controller software IRC5

1 Instructions

1.357 WriteStrBin - Writes a string to a binary I/O device

RobotWare Base

1.357 WriteStrBin - Writes a string to a binary I/O device

Usage

`WriteStrBin` (*Write String Binary*) is used to write a string to a binary I/O device or binary file.

Basic examples

The following example illustrates the instruction `WriteStrBin`:

Example 1

```
WriteStrBin channel2, "Hello World\0A";
```

The string "Hello World\0A" is written to the channel referred to by `channel2`. The string is in this case ended with new line \0A. All characters and hexadecimal values written with `WriteStrBin` will be unchanged by the system.

Arguments

```
WriteStrBin IODevice Str
```

IODevice

Data type: `iodev`

Name (reference) of the current I/O device.

Str

String

Data type: `string`

The text to be written.

Program execution

The text string is written to the specified I/O device or file.

At power fail restart, any open file or I/O device in the system will be closed and the I/O descriptor in the variable of type `iodev` will be reset.

Error handling

The following recoverable errors are generated and can be handled in an error handler. The system variable `ERRNO` will be set to:

Name	Cause of error
<code>ERR_FILEACC</code>	An error occurs during writing.

Limitations

This instruction can only be used for I/O devices or files that have been opened for binary reading and writing.

Syntax

```
WriteStrBin  
  [ IODevice '[:]=' ] <variable (VAR) of iodev> ', '  
  [ Str '[:]=' ] <expression (IN) of string> ';'
```

Continues on next page

Related information

For information about	See
Opening, etc. of I/O devices	<i>Technical reference manual - RAPID Overview</i>
Read binary sting	ReadStrBin - Reads a string from a binary I/O device or file on page 1438
File and I/O device handling	<i>Application manual - Controller software IRC5</i>

1 Instructions

1.358 WriteVar - Write variable

Sensor Interface

1.358 WriteVar - Write variable

Usage

`WriteVar` is used to write a variable to a device connected to the sensor interface. The sensor interface communicates with sensors via I/O devices.

Configuration example

This is an example of a sensor channel configuration.

These parameters belong to the type *Transmission Protocol* in the topic *Communication*.

Name	Type	Remote Address	Remote Port
sen1:	SOCKDEV	192.168.125.101	6344

Basic examples

The following example illustrates the instruction `WriteVar`:

Example 1

```
! Define variable numbers
CONST num SensorOn := 6;
CONST num XCoord := 8;
CONST num YCoord := 9;
CONST num ZCoord := 10;
VAR pos SensorPos;

! Connect to the sensor device" sen1:" (defined in sio.cfg).
SenDevice "sen1:";

! Request start of sensor measurements
WriteVar "sen1:", SensorOn, 1;

! Read a cartesian position from the sensor.
SensorPos.x := ReadVar "sen1:", XCoord;
SensorPos.y := ReadVar "sen1:", YCoord;
SensorPos.z := ReadVar "sen1:", ZCoord;

! Stop sensor
WriteVar "sen1:", SensorOn, 0;
```

Arguments

```
WriteVar device VarNo VarData [ \TaskName ]
```

device

Data type: string

The I/O device name configured in `sio.cfg` for the sensor used.

VarNo

Data type: num

The argument `VarNo` is used to select the sensor variable.

Continues on next page

VarData

Data type: num

The argument `VarData` defines the data which is to be written to the variable selected by the `VarNo` argument.

[\TaskName]

Data type: string

The argument `TaskName` makes it possible to access devices in other RAPID tasks.

Error handling

The following recoverable errors are generated and can be handled in an error handler. The system variable `ERRNO` will be set to:

Error constant (ERRNO value)	Description
SEN_NO_MEAS	Measurement failure
SEN_NOREADY	Sensor unable to handle command
SEN_GENERRO	General sensor error
SEN_BUSY	Sensor bus
SEN_UNKNOWN	Unknown sensor
SEN_EXALARM	External sensor error
SEN_CAALARM	Internal sensor error
SEN_TEMP	Sensor temperature error
SEN_VALUE	Illegal communication value
SEN_CAMCHECK	Sensor check failure
SEN_TIMEOUT	Communication error

Syntax

```
WriteVar
  [device ':='] <expression (IN) of string> ', '
  [VarNo ':='] <expression (IN) of num> ', '
  [VarData ':='] <expression (IN) of num> ', '
  ['\' TaskName ':='] <expression (IN) of string> ' ;'
```

Related information

For information about	See
Connect to a sensor device	SenDevice - connect to a sensor device on page 688
Read a sensor variable	ReadVar - Read variable from a device on page 1440
Write a sensor data block	WriteBlock - Write block of data to device on page 1102
Read a sensor data block	ReadBlock - read a block of data from device on page 584
Configuration of sensor communication	<i>Technical reference manual - System parameters</i>

1 Instructions

1.359 WriteVarArr - Write multiple variables to a sensor device

Sensor Interface

1.359 WriteVarArr - Write multiple variables to a sensor device

Usage

`WriteVarArr` is used to write up to six variables to a sensor device at the same time.

The sensor must be configured and communicating via the RobotWare option *Sensor Interface*.

Basic examples

The following example illustrates the instruction `WriteVarArr`:

Example 1

```
! Define variable numbers
CONST num jointno := 16;
CONST num unit := 19;
VAR sensorvardata writeData{3};

! Connect to the sensor device "sen1:" (defined in sio.cfg).
SenDevice "sen1:";

! Setup two variables to write
writeData{1}:=[jointno, 0, false, 1, 5];
writeData{2}:=[unit, 0, false, 1, 1];
! A varNumber of -1 will be ignored
writeData{3}:=[-1, 0, false, 1, 1];

WriteVarArr "sen1:", writeData;
```

The example shows a write request of the variables `jointno` and `unit`.

Arguments

```
WriteVarArr Device, Data, [\taskName]
```

Device

Data type: `string`

The I/O device name configured in `sio.cfg` for the sensor used.

Data

Data type: `sensorvardata`

An array variable that refers to a data definition of the variables to be written.

[\TaskName]

Data type: `string`

The argument `TaskName` makes it possible to access devices in other RAPID tasks.

Continues on next page

Error handling

The following recoverable errors are generated and can be handled in an error handler. The system variable `ERRNO` will be set to:

Name	Cause of error
SEN_NO_MEAS	Measurement failure
SEN_NOREADY	Sensor unable to handle command
SEN_GENERRO	General sensor error
SEN_BUSY	Sensor busy
SEN_UNKNOWN	Unknown sensor
SEN_EXALARM	External sensor error
SEN_CAALARM	Internal sensor error
SEN_TEMP	Sensor temperature error
SEN_VALUE	Illegal communication value
SEN_CAMCHECK	Sensor check failure
SEN_TIMEOUT	Communication error

Syntax

```
WriteVarArr
  [Device ':=' ] <expression(IN) of string> ', '
  [Data ':=' ] < array variable {*} (INOUT) of sensorvardata > ', '
  ['\ ' TaskName ':=' <expression (IN) of string> ] ';'

```

Related information

For information about	See
Connect to a sensor device	SenDevice - connect to a sensor device on page 688
Read multiple variables from a device	ReadVarArr - Read multiple variables from a sensor device on page 596
Write a sensor variable	WriteVar - Write variable on page 1112
Read a sensor variable	ReadVar - Read variable from a device on page 1440
Write a sensor data block	WriteBlock - Write block of data to device on page 1102
Read a sensor data block	ReadBlock - read a block of data from device on page 584
Multiple variable setup data for sensor interface	sensorvardata - Multiple variable setup data for sensor interface on page 1741
Configuration of sensor communication	<i>Technical reference manual - System parameters</i>

1 Instructions

1.360 WZBoxDef - Define a box-shaped world zone *World Zones*

1.360 WZBoxDef - Define a box-shaped world zone

Usage

`WZBoxDef` (*World Zone Box Definition*) is used to define a world zone that has the shape of a straight box with all its sides parallel to the axes of the World Coordinate System.

Basic examples

The following example illustrates the instruction `WZBoxDef`:

Example 1

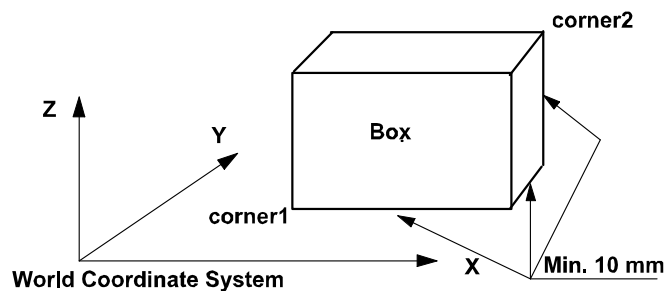

xx0500002205

```
VAR shapedata volume;  
CONST pos corner1:=[200,100,100];  
CONST pos corner2:=[600,400,400];  
...  
WZBoxDef \Inside, volume, corner1, corner2;
```

Define a straight box with coordinates parallel to the axes of the world coordinate system and defined by the opposite corners `corner1` and `corner2`.

Arguments

`WZBoxDef` [`\Inside`] | [`\Outside`] `Shape` `LowPoint` `HighPoint`

[`\Inside`]

Data type: `switch`

Define the volume inside the box.

[`\Outside`]

Data type: `switch`

Define the volume outside the box (inverse volume).

One of the arguments `\Inside` or `\Outside` must be specified.

`Shape`

Data type: `shapedata`

Variable for storage of the defined volume (private data for the system).

`LowPoint`

Data type: `pos`

Continues on next page

Position (x,y,z) in mm defining one lower corner of the box.

HighPoint

Data type: pos

Position (x,y,z) in mm defining the corner diagonally opposite to the previous one.

Program execution

The definition of the box is stored in the variable of type `shapedata` (argument `Shape`), for future use in `WZLimSup` or `WZDOSet` instructions.

Limitations

The `LowPoint` and `HighPoint` positions must be valid for opposite corners (with different x, y, and z coordinate values).

If the robot is used to point out the `LowPoint` or `HighPoint` then work object `wobj0` must be active (use of component `trans` in `robtarget` e.g. `p1.trans` as argument).

Syntax

```
WZBoxDef
  [ ['\ ' Inside] | ['\ ' Outside] ', ' ]
  [ LowPoint ' := ' ] <expression (IN) of pos> ', '
  [ Shape ' := ' ] <variable (VAR) of shapedata> ', '
  [ HighPoint ' := ' ] <expression (IN) of pos> ';'
```

Related information

For information about	See
World Zones	<i>Technical reference manual - RAPID Overview</i>
World zone shape	shapedata - World zone shape data on page 1743
Define sphere-shaped world zone	WZSphDef - Define a sphere-shaped world zone on page 1141
Define cylinder-shaped world zone	WZCylDef - Define a cylinder-shaped world zone on page 1118
Define a world zone for home joints	WZHomeJointDef - Define a world zone for home joints on page 1131
Define a world zone for limit joints	WZLimJointDef - Define a world zone for limitation in joints on page 1134
Activate world zone limit supervision	WZLimSup - Activate world zone limit supervision on page 1138
Activate world zone digital output set	WZDOSet - Activate world zone to set digital output on page 1123

1 Instructions

1.361 WZCylDef - Define a cylinder-shaped world zone

World Zones

1.361 WZCylDef - Define a cylinder-shaped world zone

Usage

`WZCylDef` (*World Zone Cylinder Definition*) is used to define a world zone that has the shape of a cylinder with the cylinder axis parallel to the z-axis of the World Coordinate System.

Basic examples

The following example illustrates the instruction `WZCylDef`:

Example 1

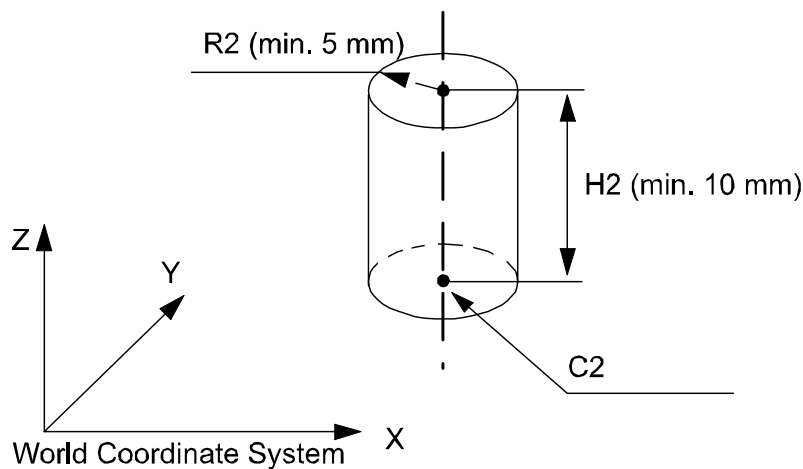

xx0500002206

```
VAR shapedata volume;  
CONST pos C2:=[300,200,200];  
CONST num R2:=100;  
CONST num H2:=200;  
...  
WZCylDef \Inside, volume, C2, R2, H2;
```

Define a cylinder with the center of the bottom circle in `C2`, radius `R2`, and height `H2`.

Arguments

`WZCylDef` [`\Inside`] | [`\Outside`] Shape CentrePoint Radius Height

[`\Inside`]

Data type: switch

Define the volume inside the cylinder.

[`\Outside`]

Data type: switch

Define the volume outside the cylinder (inverse volume).

One of the arguments `\Inside` or `\Outside` must be specified.

Continues on next page

Shape

Data type: `shapedata`

Variable for storage of the defined volume (private data for the system).

CentrePoint

Data type: `pos`

Position (x,y,z) in mm defining the center of one circular end of the cylinder.

Radius

Data type: `num`

The radius of the cylinder in mm.

Height

Data type: `num`

The height of the cylinder in mm. If it is positive (+z direction), the `CentrePoint` argument is the center of the lower end of the cylinder (as in the above example). If it is negative (-z direction) then the `CentrePoint` argument is the center of the upper end of the cylinder.

Program execution

The definition of the cylinder is stored in the variable of type `shapedata` (argument `Shape`) for future use in `WZLimSup` or `WZDOSet` instructions.

Limitations

If the robot is used to point out the `CentrePoint` then the work object `wobj0` must be active (use of component `trans` in `robtarget` e.g. `pl.trans` as argument).

Syntax

```
WZCylDef
  [ '\ ' Inside] | [ '\ ' Outside] ', '
  [ Shape ' := ' ] <variable (VAR) of shapedata> ', '
  [ CentrePoint ' := ' ] <expression (IN) of pos> ', '
  [ Radius ' := ' ] <expression (IN) of num> ', '
  [ Height ' := ' ] <expression (IN) of num> ';'
```

Related information

For information about	See
World Zones	<i>Technical reference manual - RAPID Overview</i>
World zone shape	shapedata - World zone shape data on page 1743
Define box-shaped world zone	WZBoxDef - Define a box-shaped world zone on page 1116
Define sphere-shaped world zone	WZSphDef - Define a sphere-shaped world zone on page 1141
Define a world zone for home joints	WZHomeJointDef - Define a world zone for home joints on page 1131
Define a world zone for limit joints	WZLimJointDef - Define a world zone for limitation in joints on page 1134

Continues on next page

1 Instructions

1.361 WZCylDef - Define a cylinder-shaped world zone

World Zones

Continued

For information about	See
Activate world zone limit supervision	WZLimSup - Activate world zone limit supervision on page 1138
Activate world zone digital output set	WZDOSet - Activate world zone to set digital output on page 1123

1.362 WZDisable - Deactivate temporary world zone supervision

Usage

WZDisable (*World Zone Disable*) is used to deactivate the supervision of a temporary world zone previously defined either to stop the movement or to set an output.

Basic examples

The following example illustrates the instruction WZDisable:

Example 1

```
VAR wztemporary wzzone;
...
PROC...
  WZLimSup \Temp, wzzone, volume;
  MoveL p_pick, v500, z40, tool1;
  WZDisable wzzone;
  MoveL p_place, v200, z30, tool1;
ENDPROC
```

When moving to `p_pick`, the position of the robot's TCP is checked so that it will not go inside the specified volume `wzzone`. This supervision is not performed when going to `p_place`.

Arguments

WZDisable WorldZone

WorldZone

Data type: `wztemporary`

Variable or persistent variable of type `wztemporary`, which contains the identity of the world zone to be deactivated.

Program execution

The temporary world zone is deactivated. This means that the supervision of the robot's TCP, relative to the corresponding volume, is temporarily stopped. It can be re-activated via the `WZEnable` instruction.

Limitations

Only a temporary world zone can be deactivated. A stationary world zone is always active.

Syntax

```
WZDisable
  [ WorldZone := ] <variable or persistent (INOUT) of wztemporary>
  ;
```

Related information

For information about	See
World Zones	<i>Technical reference manual - RAPID Overview</i>

Continues on next page

1 Instructions

1.362 WZDisable - Deactivate temporary world zone supervision

World Zones

Continued

For information about	See
World zone shape	shapedata - World zone shape data on page 1743
Temporary world zone data	wztemporary - Temporary world zone data on page 1809
Activate world zone limit supervision	WZLimSup - Activate world zone limit supervision on page 1138
Activate world zone set digital output	WZDOSet - Activate world zone to set digital output on page 1123
Activate world zone	WZEnable - Activate temporary world zone supervision on page 1127
Erase world zone	WZFree - Erase temporary world zone supervision on page 1129

1.363 WZDOSet - Activate world zone to set digital output

Usage

WZDOSet (*World Zone Digital Output Set*) is used to define the action and to activate a world zone for supervision of the robot movements.

After this instruction is executed, when the robot's TCP or the robot/external axes (zone in joints) is inside the defined world zone or is approaching close to it, a digital output signal is set to the specified value.

Basic examples

The following example illustrates the instruction WZDOSet:

See also [More examples on page 1125](#).

Example 1

```
VAR wztemporary service;

PROC zone_output()
  VAR shapedata volume;
  CONST pos p_service:=[500,500,700];
  ...
  WZSphDef \Inside, volume, p_service, 50;
  WZDOSet \Temp, service \Inside, volume, do_service, 1;
ENDPROC
```

Definition of temporary world zone *service* in the application program that sets the signal *do_service* when the robot's TCP is inside the defined sphere during program execution or when jogging.

Arguments

```
WZDOSet [\Temp] | [\Stat] WorldZone [\Inside] | [\Before] Shape
Signal SetValue
```

[\Temp]

Temporary

Data type: switch

The world zone to define is a temporary world zone.

[\Stat]

Stationary

Data type: switch

The world zone to define is a stationary world zone.

One of the arguments `\Temp` or `\Stat` must be specified.

WorldZone

Data type: wztemporary or wzstationary

Variable or persistent variable, that will be updated with the identity (numeric value) of the world zone.

Continues on next page

1 Instructions

1.363 WZDOSet - Activate world zone to set digital output

World Zones

Continued

If using the switch `\Temp`, the data type must be `wztemporary`. If using the switch `\Stat`, the data type must be `wzstationary`.

`[\Inside]`

Data type: `switch`

The digital output signal will be set when the robot's TCP or specified axes are inside the defined volume.

`[\Before]`

Data type: `switch`

The digital output signal will be set before the robot's TCP or specified axes reaches the defined volume (as soon as possible before the volume).

One of the arguments `\Inside` or `\Before` must be specified.

`Shape`

Data type: `shapedata`

The variable that defines the volume of the world zone.

`Signal`

Data type: `signaldo`

The name of the digital output signal that will be changed.

If a stationary worldzone is used then the signal must have the correct *internal* access level. The access level is set in the signal definition in the I/O system parameters. These concepts are further described in *Technical reference manual - System parameters*, see the types *Signal* and *Access Level*. The access level must be protected for access from the user (RAPID, FlexPendant), so the predefined internal access level can be used, or a custom access level can be defined by the user.

`SetValue`

Data type: `dionum`

Desired value of the signal (0 or 1) when the robot's TCP is inside the volume or just before it enters the volume.

When outside or just outside the volume then the signal is set to the opposite value.

Program execution

The defined world zone is activated. From this moment the robot's TCP position (or robot/external joint position) is supervised, and the output will be set when the robot's TCP position (or robot/external joint position) is inside the volume (`\Inside`) or comes close to the border of the volume (`\Before`).

If using `WZHomeJointDef` or `WZLimJointDef` together with `WZDOSet` then the digital output signal is set only if all active axes with joint space supervision are before or inside the joint space.

Continues on next page

Error handling

The following recoverable errors are generated and can be handled in an error handler. The system variable `ERRNO` will be set to:

Name	Cause of error
ERR_NO_ALIASIO_DEF	The signal variable is a variable declared in RAPID. It has not been connected to an I/O signal defined in the I/O configuration with instruction <code>AliasIO</code> .
ERR_NORUNUNIT	There is no contact with the I/O device.
ERR_SIG_NOT_VALID	The I/O signal cannot be accessed. The reasons can be that the I/O device is not running or an error in the configuration (only valid for ICI field bus).

More examples

More examples of how to use the instruction `WZDOSet` are illustrated below.

Example 1

```

VAR wztemporary home;
VAR wztemporary service;
PERS wztemporary equip1:=[];

PROC main()
...
! Definition of all temporary world zones
zone_output;
...
! equip1 in robot work area
WZEnable equip1;
...
! equip1 out of robot work area
WZDisable equip1;
...
! No use for equip1 any more
WZFree equip1;
...
ENDPROC

PROC zone_output()
VAR shapedata volume;
CONST pos p_home:=[800,0,800];
CONST pos p_service:=[800,800,800];
CONST pos p_equip1:=[-800,-800,0];
...
WZSphDef \Inside, volume, p_home, 50;
WZDOSet \Temp, home \Inside, volume, do_home, 1;
WZSphDef \Inside, volume, p_service, 50;
WZDOSet \Temp, service \Inside, volume, do_service, 1;
WZCylDef \Inside, volume, p_equip1, 300, 1000;
WZLimSup \Temp, equip1, volume;
! equip1 not in robot work area
WZDisable equip1;

```

Continues on next page

1 Instructions

1.363 WZDOSet - Activate world zone to set digital output

World Zones

Continued

ENDPROC

Definition of temporary world zones `home` and `service` in the application program, that sets the signals `do_home` and `do_service`, when the robot is inside the sphere `home` or `service` respectively during program execution or when jogging.

Also, definition of a temporary world zone `equip1`, which is active only in the part of the robot program when `equip1` is inside the working area for the robot. At that time the robot stops before entering the `equip1` volume, both during program execution and manual jogging. `equip1` can be disabled or enabled from other program tasks by using the persistent variable `equip1` value.

Limitations

A world zone cannot be redefined by using the same variable in the argument `WorldZone`.

A stationary world zone cannot be deactivated, activated again, or erased in the RAPID program.

A temporary world zone can be deactivated (`WZDisable`), activated again (`WZEnable`), or erased (`WZFree`) in the RAPID program.

Syntax

```
WZDOSet
  [['\ ' Temp] | [['\ ' Stat] ',']
  [WorldZone ':=' ] <variable or persistent (INOUT) of wztemporary>
  [['\ ' Inside] | [['\ ' Before] ',']
  [Shape ':=' ] <variable (VAR) of shapedata> ', '
  [Signal ':=' ] <variable (VAR) of signaldo> ', '
  [SetValue ':=' ] <expression (IN) of dionum> ';'
```

Related information

For information about	See
World Zones	<i>Technical reference manual - RAPID Overview</i>
World zone shape	shapedata - World zone shape data on page 1743
Temporary world zone	wztemporary - Temporary world zone data on page 1809
Stationary world zone	wzstationary - Stationary world zone data on page 1807
Define straight box-shaped world zone	WZBoxDef - Define a box-shaped world zone on page 1116
Define sphere-shaped world zone	WZSphDef - Define a sphere-shaped world zone on page 1141
Define cylinder-shaped world zone	WZCylDef - Define a cylinder-shaped world zone on page 1118
Define a world zone for home joints	WZHomeJointDef - Define a world zone for home joints on page 1131
Activate world zone limit supervision	WZLimSup - Activate world zone limit supervision on page 1138
Signal access level	<i>Technical reference manual - System parameters</i>

1.364 WZEnable - Activate temporary world zone supervision

Usage

WZEnable (*World Zone Enable*) is used to re-activate the supervision of a temporary world zone, previously defined either to stop the movement or to set an output.

Basic examples

The following example illustrates the instruction WZEnable:

Example 1

```
VAR wztemporary wzone;
...
PROC ...
  WZLimSup \Temp, wzone, volume;
  MoveL p_pick, v500, z40, tool1;
  WZDisable wzone;
  MoveL p_place, v200, z30, tool1;
  WZEnable wzone;
  MoveL p_home, v200, z30, tool1;
ENDPROC
```

When moving to `p_pick`, the position of the robot's TCP is checked so that it will not go inside the specified volume `wzone`. This supervision is not performed when going to `p_place` but is reactivated before going to `p_home`.

Arguments

WZEnable WorldZone

WorldZone

Data type: `wztemporary`

Variable or persistent variable of the type `wztemporary`, which contains the identity of the world zone to be activated.

Program execution

The temporary world zone is re-activated. Please note that a world zone is automatically activated when it is created. It need only be re-activated when it has previously been deactivated by `WZDisable`.

Limitations

Only a temporary world zone can be deactivated and reactivated. A stationary world zone is always active.

Syntax

```
WZEnable
  [ WorldZone := ] <variable or persistent (INOUT) of wztemporary>
  ;
```

Continues on next page

1 Instructions

1.364 WZEnable - Activate temporary world zone supervision

World Zones

Continued

Related information

For information about	See
World Zones	<i>Technical reference manual - RAPID Overview</i>
World zone shape	shapedata - World zone shape data on page 1743
Temporary world zone data	wztemporary - Temporary world zone data on page 1809
Activate world zone limit supervision	WZLimSup - Activate world zone limit supervision on page 1138
Activate world zone set digital output	WZDSet - Activate world zone to set digital output on page 1123
Deactivate world zone	WZDisable - Deactivate temporary world zone supervision on page 1121
Erase world zone	WZFree - Erase temporary world zone supervision on page 1129

1.365 WZFree - Erase temporary world zone supervision

Usage

WZFree (*World Zone Free*) is used to erase the definition of a temporary world zone, previously defined either to stop the movement or to set an output.

Basic examples

The following example illustrates the instruction WZFree:

Example 1

```
VAR wztemporary wzzone;
...
PROC ...
  WZLimSup \Temp, wzzone, volume;
  MoveL p_pick, v500, z40, tool1;
  WZDisable wzzone;
  MoveL p_place, v200, z30, tool1;
  WZEnable wzzone;
  MoveL p_home, v200, z30, tool1;
  WZFree wzzone;
ENDPROC
```

When moving to p_pick, the position of the robot's TCP is checked so that it will not go inside a specified volume wzzone. This supervision is not performed when going to p_place but is reactivated before going to p_home. When this position is reached then the world zone definition is erased.

Arguments

WZFree WorldZone

WorldZone

Data type: wztemporary

Variable or persistent variable of the type wztemporary, which contains the identity of the world zone to be erased.

Program execution

The temporary world zone is first deactivated and then its definition is erased. Once erased, a temporary world zone cannot be re-activated or deactivated.

Limitations

Only a temporary world zone can be deactivated, reactivated, or erased. A stationary world zone is always active.

Syntax

```
WZFree
  [ WorldZone ':='] <variable or persistent (INOUT) of wztemporary>
  ;'
```

Continues on next page

1 Instructions

1.365 WZFree - Erase temporary world zone supervision

World Zones

Continued

Related information

For information about	See
World Zones	<i>Technical reference manual - RAPID Overview</i>
World zone shape	shapedata - World zone shape data on page 1743
Temporary world zone data	wztemporary - Temporary world zone data on page 1809
Activate world zone limit supervision	WZLimSup - Activate world zone limit supervision on page 1138
Activate world zone set digital output	WZDOSet - Activate world zone to set digital output on page 1123
Deactivate world zone	WZDisable - Deactivate temporary world zone supervision on page 1121
Activate world zone	WZEnable - Activate temporary world zone supervision on page 1127

1.366 WZHomeJointDef - Define a world zone for home joints

Usage

WZHomeJointDef (*World Zone Home Joint Definition*) is used to define a world zone in joints coordinates for both the robot and external axes to be used as a HOME or SERVICE position.

Basic examples

The following example illustrates the instruction WZHomeJointDef:

Example 1

```
VAR wzstationary home;
...
PROC power_on()
  VAR shapedata joint_space;
  CONST jointtarget home_pos := [ [ 0, 0, 0, 0, 0, -45], [ 0, 9E9,
    9E9, 9E9, 9E9, 9E9] ];
  CONST jointtarget delta_pos := [ [ 2, 2, 2, 2, 2, 2], [ 5, 9E9,
    9E9, 9E9, 9E9, 9E9] ];
  ...
  WZHomeJointDef \Inside, joint_space, home_pos, delta_pos;
  WZDOSet \Stat, home \Inside, joint_space, do_home, 1;
ENDPROC
```

Definition and activation of stationary world zone home, that sets the signal do_home to 1, when all robot axes and the external axis extax.eax_a are at the joint position home_pos (within +/- delta_pos for each axis) during program execution and jogging. The variable joint_space of data type shapedata are used to transfer data from the instruction WZHomeJointDef to the instruction WZDOSet.

Arguments

```
WZHomeJointDef [\Inside] | [\Outside] Shape MiddleJointVal
DeltaJointVal
```

[\Inside]

Data type: switch

Define the joint space inside the MiddleJointVal +/- DeltaJointVal.

[\Outside]

Data type: switch

Define the joint space outside the MiddleJointVal +/- DeltaJointVal (inverse joint space).

Shape

Data type: shapedata

Variable for storage of the defined joint space (private data for the system).

MiddleJointVal

Data type: jointtarget

Continues on next page

1 Instructions

1.366 WZHomeJointDef - Define a world zone for home joints

World Zones

Continued

The position in joint coordinates for the center of the joint space to define. Specifies for each robot axis and external axis (degrees for rotational axes and mm for linear axes). Specifies in absolute joints (not in offset coordinate system

`EOffsSet-EOffsOn` for external axes). Value `9E9` for some axis means that the axis should not be supervised. Non-active external axis also gives `9E9` at programming time.

`DeltaJointVal`

Data type: `jointtarget`

The +/- delta position in joint coordinates from the center of the joint space. The value must be greater than 0 for all axes to supervise.

The following figure shows the definition of joint space for rotational axis.

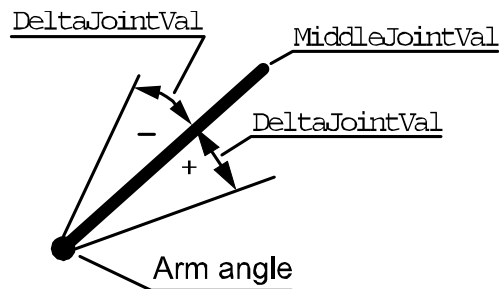

xx0500002208

The following figure shows the definition of joint space for linear axis.

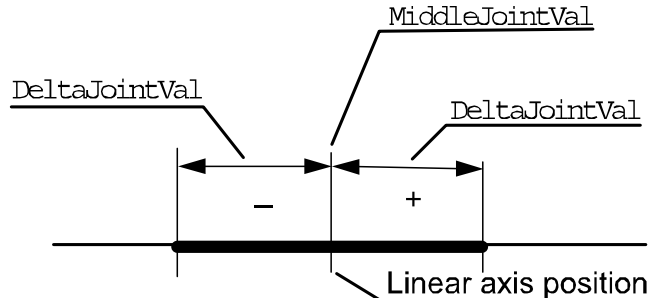

xx0500002209

Program execution

The definition of the joint space is stored in the variable of type `shapedata` (argument `Shape`) for future use in `WZLimSup` or `WZDOSet` instructions.

If use of `WZHomeJointDef` together with `WZDOSet` then the digital output signal is set but only if all active axes with joint space supervision are before or inside the joint space.

If use of `WZHomeJointDef` with outside joint space (argument `\Outside`) together with `WZLimSup` then the robot is stopped as soon as one active axes with joint space supervision reach the joint space.

If use of `WZHomeJointDef` with inside joint space (argument `\Inside`) together with `WZLimSup` then the robot is stopped as soon as the last active axes with joint space supervision reach the joint space. That means that one or several axes, but not all active and supervised axes, can be inside the joint space at the same time.

Continues on next page

At execution of the instruction `ActUnit` or `DeactUnit` for activation or deactivation of mechanical units, the supervision status for HOME position or work area limitation will be updated.

Limitations



xx010000002

Only active mechanical units and their active axes at activation time of the world zone (with instruction `WZDOSet` respectively `WZLimSup`), are included in the supervision of the HOME position respectively to the limitation of the working area. Besides that, the mechanical unit and its axes must still be active at the program movement or jogging to be supervised.

For example, if one axis with supervision is outside its HOME joint position but is deactivated then it does not prevent the digital output signal for the HOME joint position to be set if all other active axes with joint space supervision are inside the HOME joint position. At activation of that axis again it will be included in the supervision and the robot system will then be outside the HOME joint position and the digital output will be reset.

Syntax

```
WZHomeJointDef
[ ['\ ' Inside] | ['\ ' Outside] ', ' ]
[ Shape ' := ' ] <variable (VAR) of shapedata> ', '
[ MiddleJointVal ' := ' ] <expression (IN) of jointtarget> ', '
[ DeltaJointVal ' := ' ] <expression (IN) of jointtarget> ';'
```

Related information

For information about	See
World Zones	<i>Technical reference manual - RAPID Overview</i>
World zone shape	shapedata - World zone shape data on page 1743
Define box-shaped world zone	WZBoxDef - Define a box-shaped world zone on page 1116
Define cylinder-shaped world zone	WZCylDef - Define a cylinder-shaped world zone on page 1118
Define sphere-shaped world zone	WZSphDef - Define a sphere-shaped world zone on page 1141
Define a world zone for limit joints	WZLimJointDef - Define a world zone for limitation in joints on page 1134
Activate world zone limit supervision	WZLimSup - Activate world zone limit supervision on page 1138
Activate world zone digital output set	WZDOSet - Activate world zone to set digital output on page 1123

1 Instructions

1.367 WZLimJointDef - Define a world zone for limitation in joints

World Zones

1.367 WZLimJointDef - Define a world zone for limitation in joints

Usage

WZLimJointDef (*World Zone Limit Joint Definition*) is used to define a world zone in joints coordinates for both the robot and external axes, to be used for limitation of the working area.

With WZLimJointDef it is possible to limit the working area for each robot and external axes in the RAPID program, besides the limitation that can be done with system parameters *Motion - Arm - robx_y - Upper Joint Bound ... Lower Joint Bound*.

Basic examples

The following example illustrates the instruction WZLimJointDef:

Example 1

```
VAR wzstationary work_limit;
...
PROC power_on()
  VAR shapedata joint_space;
  CONST jointtarget low_pos:= [ [ -90, 9E9, 9E9, 9E9, 9E9, 9E9],
    [ -1000, 9E9, 9E9, 9E9, 9E9, 9E9]];
  CONST jointtarget high_pos := [ [ 90, 9E9, 9E9, 9E9,9E9, 9E9],
    [ 9E9, 9E9, 9E9, 9E9, 9E9, 9E9] ];
  ...
  WZLimJointDef \Outside, joint_space, low_pos, high_pos;
  WZLimSup \Stat, work_limit, joint_space;
ENDPROC
```

Definition and activation of stationary world zone `work_limit`, that limit the working area for robot axis 1 to -90 and +90 degrees and the external axis `extax.eax_a` to -1000 mm during program execution and jogging. The variable `joint_space` of data type `shapedata` are used to transfer data from the instruction WZLimJointDef to the instruction WZLimSup.

Arguments

WZLimJointDef [`\Inside`] | [`\Outside`] Shape LowJointVal HighJointVal

[`\Inside`]

Data type: switch

Define the joint space inside the LowJointVal ... HighJointVal.

[`\Outside`]

Data type: switch

Define the joint space outside the LowJointVal ... HighJointVal (inverse joint space).

Shape

Data type: shapedata

Variable for storage of the defined joint space (private data for the system).

Continues on next page

LowJointVal

Data type: jointtarget

The position in joint coordinates for the low limit of the joint space to define. Specifies for each robot axes and external axes (degrees for rotational axes and mm for linear axes). Specifies in absolute joints (not in offset coordinate system `EOffsSet` or `EOffsOn` for external axes). Value `9E9` for some axis means that the axis should not be supervised for low limit. Non-active external axis also gives `9E9` at programming time.

HighJointVal

Data type: jointtarget

The position in joint coordinates for the high limit of the joint space to define. Specifies for each robot axes and external axes (degrees for rotational axes and mm for linear axes). Specifies in absolute joints (not in offset coordinate system `EOffsSet` or `EOffsOn` for external axes). Value `9E9` for an axis means that the axis should not be supervised for high limit. Non-active external axis also gives `9E9` at programming time.

`HighJointVal` minus `LowJointVal` for each axis must be greater than 0 for all axes to supervise.

The figure below shows definition of joint space for rotating axis.

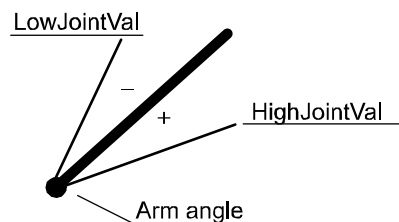

xx0500002281

The figure below shows definition of joint space for linear axis.



xx0100000002

Program execution

The definition of the joint space is stored in the variable of type `shapedata` (argument `Shape`) for future use in `WZLimSup` or `WZDOSet` instructions.

If using `WZLimJointDef` together with `WZDOSet` then the digital output signal is set, only if all active axes with joint space supervision are before or inside the joint space.

If using `WZLimJointDef` with outside joint space (argument `\Outside`) together with `WZLimSup` then the robot is stopped as soon as one active axes with joint space supervision reaches the joint space.

Continues on next page

1 Instructions

1.367 WZLimJointDef - Define a world zone for limitation in joints

World Zones

Continued

If using `WZLimJointDef` with inside joint space (argument `\Inside`) together with `WZLimSup` then the robot is stopped as soon as the last active axes with joint space supervision reaches the joint space. That means that one or several axes but not all active and supervised axes can be inside the joint space at the same time.

At execution of the instruction `ActUnit` or `DeactUnit` the supervision status will be updated.

Limitations



xx0100000002

WARNING!

Only active mechanical units and its active axes at activation time of the world zone (with instruction `WZDOSet` respective to `WZLimSup`), are included in the supervision of the HOME position respectively the limitation of the working area. Besides that, the mechanical unit and its axes must still be active at the program movement or jogging to be supervised.

For example, if one axis with supervision is outside its HOME joint position but is deactivated then it does not prevent the digital output signal for the HOME joint position to be set if all other active axes with joint space supervision are inside the HOME joint position. At activation of that axis again, it will be included in the supervision and the robot system will be outside the HOME joint position and the digital output will be reset.

Syntax

```
WZLimJointDef
[ ['\' Inside] | ['\' Outside] ',']
[ Shape ':='] <variable (VAR) of shapedata> ', '
[ LowJointVal ':='] <expression (IN) of jointtarget> ', '
[ HighJointVal ':='] <expression (IN) of jointtarget> ';'
```

Related information

For information about	See
World Zones	<i>Technical reference manual - RAPID Overview</i>
World zone shape	shapedata - World zone shape data on page 1743
Define box-shaped world zone	WZBoxDef - Define a box-shaped world zone on page 1116
Define cylinder-shaped world zone	WZCylDef - Define a cylinder-shaped world zone on page 1118
Define sphere-shaped world zone	WZSphDef - Define a sphere-shaped world zone on page 1141
Define a world zone for home joints	WZHomeJointDef - Define a world zone for home joints on page 1131
Activate world zone limit supervision	WZLimSup - Activate world zone limit supervision on page 1138

Continues on next page

1.367 WZLimJointDef - Define a world zone for limitation in joints

World Zones

Continued

For information about	See
Activate world zone digital output set	WZDOSet - Activate world zone to set digital output on page 1123

1 Instructions

1.368 WZLimSup - Activate world zone limit supervision

World Zones

1.368 WZLimSup - Activate world zone limit supervision

Usage

WZLimSup (*World Zone Limit Supervision*) is used to define the action and to activate a world zone for supervision of the working area of the robot or external axes.

After this instruction is executed, when the robot's TCP reaches the defined world zone or when the robot/external axes reaches the defined world zone in joints, then the movement is stopped both during program execution and when jogging.

Basic examples

The following example illustrates the instruction WZLimSup:

See also [More examples on page 1139](#).

Example 1

```
VAR wzstationary max_workarea;
...
PROC POWER_ON()
  VAR shapedata volume;
  ...
  WZBoxDef \Outside, volume, corner1, corner2;
  WZLimSup \Stat, max_workarea, volume;
ENDPROC
```

Definition and activation of stationary world zone `max_workarea`, with the shape of the area outside a box (temporarily stored in `volume`) and the action work-area supervision. The robot stops with an error message before entering the area outside the box.

Arguments

WZLimSup [`\Temp`] | [`\Stat`] WorldZone Shape

[`\Temp`]

Temporary

Data type: switch

The world zone to define is a temporary world zone.

[`\Stat`]

Stationary

Data type: switch

The world zone to define is a stationary world zone.

One of the arguments `\Temp` or `\Stat` must be specified.

WorldZone

Data type: `wztemporary` or `wzstationary`

Variable or persistent variable that will be updated with the identity (numeric value) of the world zone.

Continues on next page

If using switch `\Temp`, the data type must be `wztemporary`. If using switch `\Stat`, the data type must be `wzstationary`.

Shape

Data type: `shapedata`

The variable that defines the volume of the world zone.

Program execution

The defined world zone is activated. From this moment the robot's TCP position or the robot/external axes joint position are supervised. If it reaches the defined area then the movement is stopped.

If using `WZLimJointDef` or `WZHomeJointDef` with outside joint space (argument `\Outside`) together with `WZLimSup` then the robot is stopped as soon as one active axes with joint space supervision reaches the joint space.

If using `WZLimJointDef` or `WZHomeJointDef` with inside joint space (argument `\Inside`) together with `WZLimSup` then the robot is stopped as soon as the last active axes with joint space supervision reaches the joint space. That means that one or several axes but not all active and supervised axes can be inside the joint space at the same time.

At execution of the instruction `ActUnit` or `DeactUnit` the supervision status will be updated.

More examples

More examples of how to use the instruction `WZLimSup` are illustrated below.

Example 1

```
VAR wzstationary box1_invers;
VAR wzstationary box2;

PROC wzone_power_on()
  VAR shapedata volume;
  CONST pos box1_c1:=[500,-500,0];
  CONST pos box1_c2:=[-500,500,500];
  CONST pos box2_c1:=[500,-500,0];
  CONST pos box2_c2:=[200,-200,300];
  ...
  WZBoxDef \Outside, volume, box1_c1, box1_c2;
  WZLimSup \Stat, box1_invers, volume;
  WZBoxDef \Inside, volume, box2_c1, box2_c2;
  WZLimSup \Stat, box2, volume;
ENDPROC
```

Limitation of work area for the robot with the following stationary world zones:

- Outside working area when outside `box1_invers`
- Outside working area when inside `box2`

If this routine is connected to the system event `POWER ON` then these world zones will always be active in the system, both for program movements and manual jogging.

Continues on next page

1 Instructions

1.368 WZLimSup - Activate world zone limit supervision

World Zones

Continued

Limitations

A world zone cannot be redefined using the same variable in argument `WorldZone`.

A stationary world zone cannot be deactivated, activated again, or erased in the RAPID program.

A temporary world zone can be deactivated (`WZDisable`), activated again (`WZEnable`), or erased (`WZFree`) in the RAPID program.

Syntax

```
WZLimSup
[ ['\ ' Temp] | ['\Stat' ' ,']
[ WorldZone ':=' ] <variable or persistent (INOUT) of wztemporary>
  ,
[ Shape ':=' ] <variable (VAR) of shapedata> ';' ;
```

Related information

For information about	See
World Zones	<i>Technical reference manual - RAPID Overview</i>
World zone shape	shapedata - World zone shape data on page 1743
Temporary world zone	wztemporary - Temporary world zone data on page 1809
Stationary world zone	wzstationary - Stationary world zone data on page 1807
Define straight box-shaped world zone	WZBoxDef - Define a box-shaped world zone on page 1116
Define sphere-shaped world zone	WZSphDef - Define a sphere-shaped world zone on page 1141
Define cylinder-shaped world zone	WZCylDef - Define a cylinder-shaped world zone on page 1118
Define a world zone for home joints	WZHomeJointDef - Define a world zone for home joints on page 1131
Define a world zone for limit joints	WZLimJointDef - Define a world zone for limitation in joints on page 1134
Activate world zone digital output set	WZDOSet - Activate world zone to set digital output on page 1123

1.369 WZSphDef - Define a sphere-shaped world zone

Usage

WZSphDef (*World Zone Sphere Definition*) is used to define a world zone that has the shape of a sphere.

Basic examples

The following example illustrates the instruction WZSphDef:

Example 1

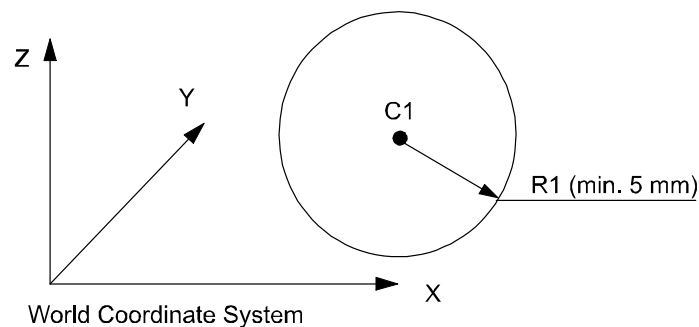

xx0500002207

```

VAR shapedata volume;
CONST pos C1:=[300,300,200];
CONST num R1:=200;
...
WZSphDef \Inside, volume, C1, R1;

```

Define a sphere named `volume` by its center `C1` and its radius `R1`.

Arguments

WZSphDef [`\Inside`] | [`\Outside`] Shape CentrePoint Radius

[`\Inside`]

Data type: `switch`

Define the volume inside the sphere.

[`\Outside`]

Data type: `switch`

Define the volume outside the sphere (inverse volume).

One of the arguments `\Inside` or `\Outside` must be specified.

Shape

Data type: `shapedata`

Variable for storage of the defined volume (private data for the system).

CentrePoint

Data type: `pos`

Continues on next page

1 Instructions

1.369 WZSphDef - Define a sphere-shaped world zone

World Zones

Continued

Position (x,y,z) in mm defining the center of the sphere.

Radius

Data type: num

The radius of the sphere in mm.

Program execution

The definition of the sphere is stored in the variable of type `shapedata` (argument `Shape`), for future use in `WZLimSup` or `WZDOSet` instructions.

Limitations

If the robot is used to point out the `CentrePoint` then the work object `wobj0` must be active (use of component `trans` in `robtarget` e.g. `p1.trans` as argument).

Syntax

```
WZSphDef
  [ ['\ ' Inside] | ['\ ' Outside] ', ' ]
  [ Shape ' := ' ] <variable (VAR) of shapedata> ', '
  [ CentrePoint ' := ' ] <expression (IN) of pos> ', '
  [ Radius ' := ' ] <expression (IN) of num> ';'
```

Related information

For information about	See
World Zones	<i>Technical reference manual - RAPID Overview</i>
World zone shape	shapedata - World zone shape data on page 1743
Define box-shaped world zone	WZBoxDef - Define a box-shaped world zone on page 1116
Define cylinder-shaped world zone	WZCylDef - Define a cylinder-shaped world zone on page 1118
Define a world zone for home joints	WZHomeJointDef - Define a world zone for home joints on page 1131
Define a world zone for limit joints	WZLimJointDef - Define a world zone for limitation in joints on page 1134
Activate world zone limit supervision	WZLimSup - Activate world zone limit supervision on page 1138
Activate world zone digital output set	WZDOSet - Activate world zone to set digital output on page 1123

2 Functions

2.1 Abs - Gets the absolute value

Usage

`Abs` is used to get the absolute value, that is, a positive value of numeric data.

Basic examples

The following example illustrates the function `Abs`.

See also [More examples on page 1143](#).

Example 1

```
reg1 := Abs(reg2);
```

`Reg1` is assigned the absolute value of `reg2`.

Return value

Data type: `num`

The absolute value, that is, a positive numeric value, for example:

Input value	Returned value
3	3
-3	3
-2.53	2.53

Arguments

`Abs (Value)`

Value

Data type: `num`

The input value.

More examples

More examples of the function `Abs` are illustrated below.

Example 1

```
TPReadNum no_of_parts, "How many parts should be produced? ";
no_of_parts := Abs(no_of_parts);
```

The operator is asked to input the number of parts to be produced. To ensure that the value is greater than zero, the value given by the operator is made positive.

Syntax

```
Abs '('
  [ Value ':= ' ] < expression (IN) of num > ')'
```

A function with a return value of the data type `num`.

Continues on next page

2 Functions

2.1 Abs - Gets the absolute value

RobotWare Base

Continued

Related information

For information about	See
Mathematical instructions and functions	<i>Technical reference manual - RAPID Overview</i>

2.2 AbsDnum - Gets the absolute value of a dnum

Usage

AbsDnum is used to get the absolute value, that is, a positive value of a dnum numeric value.

Basic examples

The following example illustrates the function AbsDnum.

See also [More examples on page 1145](#).

Example 1

```
VAR dnum value1;
VAR dnum value2:=-20000000;
value1 := AbsDnum(value2);
```

Value1 is assigned the absolute value of value2.

Return value

Data type: dnum

The absolute value, that is, a positive numeric value, for example:

Input value	Returned value
3	3
-3	-3
-2.53	2.53
-4503599627370496	4503599627370496

Arguments

AbsDnum (Value)

Value

Data type: dnum

The input value.

More examples

More examples of the function AbsDnum are illustrated below.

Example 1

```
TPReadDnum no_of_parts, "How many parts should be produced? ";
no_of_parts := AbsDnum(no_of_parts);
```

The operator is asked to input the number of parts to be produced. To ensure that the value is greater than zero, the value given by the operator is made positive.

Syntax

```
AbsDnum '('
  [ Value ':= ' ] < expression (IN) of dnum > ')'
```

A function with a return value of the data type dnum.

Continues on next page

2 Functions

2.2 AbsDnum - Gets the absolute value of a dnum

RobotWare Base

Continued

Related information

For information about	See
Mathematical instructions and functions	<i>Technical reference manual - RAPID Overview</i>

2.3 ACos - Calculates the arc cosine value

Usage

ACos (*Arc Cosine*) is used to calculate the arc cosine value on data types num..

Basic examples

The following example illustrates the function ACos.

Example 1

```
VAR num angle;
VAR num value;
...
...
angle := ACos(value);
angle will get the arc cosine value of value.
```

Return value

Data type: num

The arc cosine value, expressed in degrees, range [0, 180].

Arguments

ACos (Value)

Value

Data type: num

The argument value must be in range [-1, 1].

Limitations

The execution of the function ACos(x) will give an error if x is outside the range [-1, 1].

Syntax

```
ACos '('
  [Value ':='] <expression (IN) of num>')'
```

A function with a return value of the data type num.

Related information

For information about	See
Mathematical instructions and functions	<i>Technical reference manual - RAPID Overview</i>

2 Functions

2.4 ACosDnum - Calculates the arc cosine value

RobotWare Base

2.4 ACosDnum - Calculates the arc cosine value

Usage

ACosDnum (*Arc Cosine dnum*) is used to calculate the arc cosine value on data types dnum.

Basic examples

The following example illustrates the function ACosDnum.

Example 1

```
VAR dnum angle;  
VAR dnum value;  
...  
...  
angle := ACosDnum(value);  
angle will get the arc cosine value of value.
```

Return value

Data type: dnum

The arc cosine value, expressed in degrees, range [0, 180].

Arguments

ACosDnum (Value)

Value

Data type: dnum

The argument value must be in range [-1, 1].

Limitations

The execution of the function ACosDnum(x) will give an error if x is outside the range [-1, 1].

Syntax

```
ACosDnum '('  
    [Value ':='] <expression (IN) of dnum>')'
```

A function with a return value of the data type dnum.

Related information

For information about	See
Mathematical instructions and functions	<i>Technical reference manual - RAPID Overview</i>

2.5 AInput - Reads the value of an analog input signal

Usage

AInput is used to read the current value of an analog input signal.



Note

Note that the function AInput is a legacy function that no longer has to be used. See the examples for an alternative and recommended way of programming.

Basic examples

The following example illustrates the function AInput.

See also [More examples on page 1150](#).

Example 1

```
IF AInput(ai1) < 1.5 THEN ...
...
IF ai1 < 1.5 THEN ...
```

If the current value of the signal ai1 is less than 1.5, then ...

Return value

Data type: num

The current value of the signal.

The current value is scaled (in accordance with the system parameters) before it is read by the RAPID program. A diagram of how analog signal values are scaled is shown in the following figure:

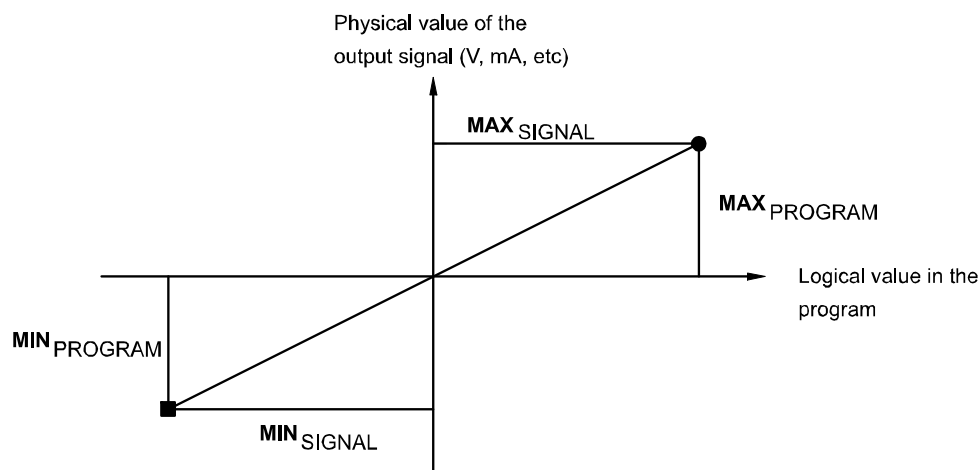

xx0500002408

Arguments

AInput (Signal)

Signal

Data type: signalai

Continues on next page

2 Functions

2.5 AInput - Reads the value of an analog input signal

RobotWare Base

Continued

The name of the analog input to be read.

More examples

More examples of how to use the function `AInput` are illustrated below.

Example 1

```
WHILE AInput(current) > 35 DO ...  
...  
WHILE current > 35 DO ...
```

As long as the current value of the signal `current` is greater than 35, execute ...

Example 2

```
deviation := 3 * AInput(sensor) + 10;  
...  
deviation := 3 * sensor + 10;
```

The deviation is calculated based on the value of the signal `sensor` and stored in the variable `deviation`.

Syntax

```
AInput '('  
  [ Signal ':= ' ] < variable (VAR) of signalai > ')'
```

A function with a return value of the data type `num`.

Related information

For information about	See
Input/Output instructions	<i>Technical reference manual - RAPID Overview, section RAPID Summary - Input and Output Signals</i>
Input/Output functionality in general	<i>Technical reference manual - RAPID Overview, section Motion and I/O Principles - I/O principles</i>
Configuration of I/O	<i>Technical reference manual - System parameters</i>

2.6 AND - Evaluates a logical value

Usage

AND is a function used to evaluate two conditional expressions (true/false).

Basic examples

The following examples illustrate the function AND.

Example 1

```

VAR num a;
VAR num b;
VAR bool c;
...
c := a>5 AND b=3;

```

The return value of `c` is **TRUE** if `a` is larger than 5 and `b` equals 3. Otherwise the return value is **FALSE**.

Example 2

```

VAR num mynum;
VAR string mystring;
VAR bool mybool;
VAR bool result;
...
result := mystring="Hello" AND mynum<15 OR mybool;

```

The return value of `result` is **TRUE** if both `mystring` is "Hello" and `mynum` is smaller than 15. Or if `mybool` is **TRUE**. Otherwise the return value is **FALSE**.

The **AND** statement is evaluated first, thereafter the **OR** statement. This is illustrated by the parentheses in the below row.

```

result := (mystring="Hello" AND mynum<15) OR mybool;

```

Return value

Data type: `bool`

The return value is **TRUE** if both conditional expressions are correct, otherwise the return value is **FALSE**.

Syntax

```

<expression of bool> AND <expression of bool>

```

A function with a return value of data type `bool`.

Related information

For information about	See
Logical bitwise AND - operation on <code>byte</code> data	BitAnd - Logical bitwise AND - operation on byte data on page 1164
Logical bitwise AND - operation on <code>dnum</code> data	BitAndDnum - Logical bitwise AND - operation on dnum data on page 1166
OR	OR - Evaluates a logical value on page 1384
XOR	XOR - Evaluates a logical value on page 1596

Continues on next page

2 Functions

2.6 AND - Evaluates a logical value

RobotWare Base

Continued

For information about	See
NOT	NOT - Inverts a logical value on page 1375
Expressions	<i>Technical reference manual - RAPID Overview</i>

2.7 AOutput - Reads the value of an analog output signal

Usage

AOutput is used to read the current value of an analog output signal.

Basic examples

The following example illustrates the function AOutput.

Example 1

```
IF AOutput(ao4) > 5 THEN ...
```

If the current value of the signal ao4 is greater than 5, then ...

Return value

Data type: num

The current value of the signal.

The current value is scaled (in accordance with the system parameters) before it is read by the RAPID program. A diagram of how analog signal values are scaled is shown in the following figure:

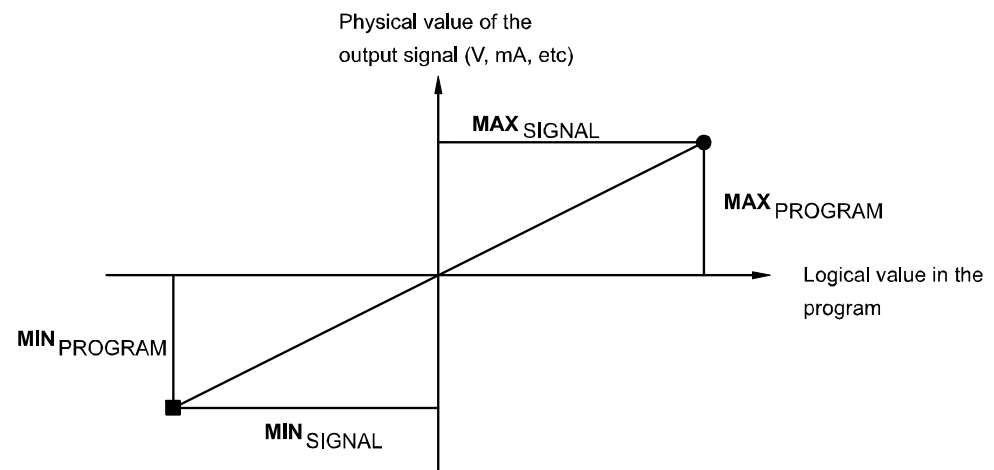

xx0500002408

Arguments

AOutput (Signal)

Signal

Data type: signalao

The name of the analog output to be read.

Continues on next page

2 Functions

2.7 AOutput - Reads the value of an analog output signal

RobotWare Base

Continued

Error handling

The following recoverable errors are generated and can be handled in an error handler. The system variable `ERRNO` will be set to:

Name	Cause of error
<code>ERR_NO_ALIASIO_DEF</code>	The signal variable is a variable declared in RAPID. It has not been connected to an I/O signal defined in the I/O configuration with instruction <code>AliasIO</code> .
<code>ERR_NORUNUNIT</code>	There is no contact with the I/O device.
<code>ERR_SIG_NOT_VALID</code>	The I/O signal cannot be accessed. The reasons can be that the I/O device is not running or an error in the configuration (only valid for ICI field bus).

Syntax

```
AOutput '('  
  [ Signal ':=' ] < variable (VAR) of signalao > ')'
```

A function with a return value of data type `num`.

Related information

For information about	See
Set an analog output signal	SetAO - Changes the value of an analog output signal on page 694
Input/Output instructions	<i>Technical reference manual - RAPID Overview, section RAPID Summary - Input and Output Signals</i>
Input/Output functionality in general	<i>Technical reference manual - RAPID Overview, section Motion and I/O Principles - I/O principles</i>
Configuration of I/O	<i>Technical reference manual - System parameters</i>

2.8 ArgName - Gets argument name

Usage

`ArgName` (*Argument Name*) is used to get the name of the original data object for the current argument or the current data.

Basic examples

The following example illustrates the function `ArgName`.

See also [More examples on page 1156](#).

Example 1

```
VAR num chales :=5;
...
procl chales;
PROC procl (num par1)
  VAR string name;
  ...
  name:=ArgName(par1);
  TPWrite "Argument name "+name+" with value "\Num:=par1;
ENDPROC
```

The variable `name` is assigned the string value "chales" and on FlexPendant the following string is written: "Argument name chales with value 5".

Return value

Data type: string

The original data object name.

Arguments

`ArgName` (Parameter [`\ErrorNumber`])

Parameter

Data type: anytype

The formal parameter identifier (for the routine in which `ArgName` is located) or the data identity.

All types of data with structure atomic, record, record component, array, or array element can be used.

ErrorNumber

Data type: errnum

A variable (before used it is set to 0 by the system) that will hold the error code when the argument is an expression value, argument is not present or argument is of type switch. If this optional variable is omitted then the error handler will be executed.

Program execution

The function returns the original data object name for an entire object of the type constant, variable, or persistent. The original data object can be global, local in the program module, or local in a routine (normal RAPID scope rules).

Continues on next page

2 Functions

2.8 ArgName - Gets argument name

RobotWare Base

Continued

If it is a part of a data object then the name of the whole data object is returned.

Error handling

The following recoverable errors are generated and can be handled in an error handler. The system variable `ERRNO` will be set to:

Name	Cause of error
ERR_ARGNAME	<ul style="list-style-type: none">• Argument is expression value• Argument is not present• Argument is of type switch

More examples

More examples of the function `ArgName` are illustrated below.

Convert from identifier to string

This function can also be used to convert from identifier to `string`, by specifying the identifier in the argument `Parameter` for any data object with global, local in module, or local in routine scope:

```
VAR num chales :=5;
...
proc1;

PROC proc1 ()
  VAR string name;
  ...
  name:=ArgName(chales);
  TPWrite "Global data object "+name+" has value "\Num:=chales;
ENDPROC
```

The variable `name` is assigned the string value "chales" and on FlexPendant the following string is written: "Global data object chales has value 5".

Routine call in several steps

Note that the function returns the original data object name:

```
VAR num chales :=5;
...
proc1 chales;
...
PROC proc1 (num parameter1)
  ...
  proc2 parameter1;
  ...
ENDPROC

PROC proc2 (num par1)
  VAR string name;
  ...
  name:=ArgName(par1);
  TPWrite "Original data object name "+name+" with value"
        \Num:=par1;
ENDPROC
```

Continues on next page

The variable `name` is assigned the string value "chales" and on FlexPendant the following string is written: "Original data object name chales with value 5".

Supress execution in error handler

```

PROC main()
  VAR string mystring:="DUMMY";
  procl mystring;
  procl "This is a test";
  ...
ENDPROC

PROC procl (string parl)
  VAR string name;
  VAR errnum myerrnum;

  name := ArgName(parl \ErrorNumber:=myerrnum);
  IF myerrnum=ERR_ARGNAME THEN
    TPWrite "The argument parl is an expression value";
    TPWrite "The name of the argument can not be evaluated";
  ELSE
    TPWrite "The name on the argument is "+name;
  ENDIF
ENDPROC

```

The variable `name` is assigned the string value "mystring" when the first call to `procl` is done. When the second call to `procl` is done, an empty string is assign to `name`. On the FlexPendant the following string is written: "The argument `parl` is an expression value" and "The name of the argument can not be evaluated".

Syntax

```

ArgName '('
  [ Parameter ':= ' ] < reference (REF) of anytype>
  ['\ ' ErrorNumber ':= ' <var or pers (INOUT) of errnum> ] ')'

```

A function with a return value of the data type `string`.

Related information

For information about	See
String functions	<i>Technical reference manual - RAPID Overview</i>
Definition of string	string - Strings on page 1761
String values	<i>Technical reference manual - RAPID Overview</i>
<i>Advanced RAPID</i>	<i>Advanced RAPID</i>

2 Functions

2.9 ASin - Calculates the arc sine value

RobotWare Base

2.9 ASin - Calculates the arc sine value

Usage

ASin (*Arc Sine*) is used to calculate the arc sine value on data types `num`.

Basic examples

The following example illustrates the function ASin

Example 1

```
VAR num angle;  
VAR num value;  
...  
...  
angle := ASin(value);  
angle will get the arc sine value of value
```

Return value

Data type: `num`

The arc sine value, expressed in degrees, range [-90, 90].

Arguments

ASin (Value)

Value

Data type: `num`

The argument value must be in range [-1, 1].

Limitations

The execution of the function ASin(x) will give an error if x is outside the range [1, -1].

Syntax

```
ASin '('  
    [Value ':='] <expression (IN) of num> ')'
```

A function with a return value of the data type `num`.

Related information

For information about	See
Mathematical instructions and functions	<i>Technical reference manual - RAPID Overview</i>

2.10 ASinDnum - Calculates the arc sine value

Usage

ASinDnum (*Arc Sine dnum*) is used to calculate the arc sine value on data types dnum.

Basic examples

The following example illustrates the function ASinDnum

Example 1

```
VAR dnum angle;
VAR dnum value;
...
...
angle := ASinDnum(value);
angle will get the arc sine value of value
```

Return value

Data type: dnum

The arc sine value, expressed in degrees, range [-90, 90].

Arguments

ASinDnum (Value)

Value

Data type: dnum

The argument value must be in range [-1, 1].

Limitations

The execution of the function ASinDnum(x) will give an error if x is outside the range [-1, 1].

Syntax

```
ASinDnum '('
  [Value ':='] <expression (IN) of dnum> ')'
```

A function with a return value of the data type dnum.

Related information

For information about	See
Mathematical instructions and functions	<i>Technical reference manual - RAPID Overview</i>

2 Functions

2.11 ATan - Calculates the arc tangent value

RobotWare Base

2.11 ATan - Calculates the arc tangent value

Usage

ATan (*Arc Tangent*) is used to calculate the arc tangent value on data types `num`.

Basic examples

The following example illustrates the function ATan.

Example 1

```
VAR num angle;  
VAR num value;  
...  
...  
angle := ATan(value);  
angle will get the arc tangent value of value.
```

Return value

Data type: `num`

The arc tangent value, expressed in degrees, range [-90, 90].

Arguments

ATan (Value)

Value

Data type: `num`

The argument value.

Syntax

```
ATan '('  
    [Value ':=' ] <expression (IN) of num> ')'
```

A function with a return value of the data type `num`.

Related information

For information about	See
Mathematical instructions and functions	<i>Technical reference manual - RAPID Overview</i>
Arc tangent with a return value in the range [-180, 180]	ATan2 - Calculates the arc tangent2 value on page 1162

2.12 ATanDnum - Calculates the arc tangent value

Usage

ATanDnum (*Arc Tangent dnum*) is used to calculate the arc tangent value on data types dnum.

Basic examples

The following example illustrates the function ATanDnum.

Example 1

```
VAR dnum angle;
VAR dnum value;
...
...
angle := ATanDnum(value);
angle will get the arc tangent value of value.
```

Return value

Data type: dnum

The arc tangent value, expressed in degrees, range [-90, 90].

Arguments

ATanDnum (Value)

Value

Data type: dnum

The argument value.

Syntax

```
ATanDnum '('
  [Value ':=' ] <expression (IN) of dnum> ')'
```

A function with a return value of the data type dnum.

Related information

For information about	See
Mathematical instructions and functions	<i>Technical reference manual - RAPID Overview</i>
Arc tangent with a return value in the range [-180, 180]	ATan2 - Calculates the arc tangent2 value on page 1162

2 Functions

2.13 ATan2 - Calculates the arc tangent2 value

RobotWare Base

2.13 ATan2 - Calculates the arc tangent2 value

Usage

ATan2 (*Arc Tangent2*) is used to calculate the arc tangent2 value on data types num.

Basic examples

The following example illustrates the function ATan2.

Example 1

```
VAR num angle;  
VAR num x_value;  
VAR num y_value;  
...  
...  
angle := ATan2(y_value, x_value);  
angle will get the arc tangent value of y_value/x_value.
```

Return value

Data type: num

The arc tangent value, expressed in degrees, range [-180, 180]. The value will be equal to ATan(y/x) but in the range of [-180, 180] since the function uses the sign of both arguments to determine the quadrant of the return value.

Arguments

ATan2 (Y X)

Y

Data type: num

The numerator argument value.

X

Data type: num

The denominator argument value.

Syntax

```
ATan2 '('  
  [Y ':=' ] <expression (IN) of num> ','  
  [X ':=' ] <expression (IN) of num> ')'
```

A function with a return value of the data type num.

Related information

For information about	See
Mathematical instructions and functions	<i>Technical reference manual - RAPID Overview</i>
Arc tangent with only one argument	ATan - Calculates the arc tangent value on page 1160

2.14 ATan2Dnum - Calculates the arc tangent2 value

Usage

ATan2Dnum (*Arc Tangent2 dnum*) is used to calculate the arc tangent2 value on data types dnum.

Basic examples

The following example illustrates the function ATan2Dnum.

Example 1

```

VAR dnum angle;
VAR dnum x_value;
VAR dnum y_value;
...
...
angle := ATan2Dnum(y_value, x_value);

```

angle will get the arc tangent value of y_value/x_value.

Return value

Data type: dnum

The arc tangent value, expressed in degrees, range [-180, 180]. The value will be equal to ATanDnum(y/x) but in the range of [-180, 180] since the function uses the sign of both arguments to determine the quadrant of the return value.

Arguments

ATan2Dnum (Y X)

Y

Data type: dnum

The numerator argument value.

X

Data type: dnum

The denominator argument value.

Syntax

```

ATan2Dnum '('
  [Y ':=' ] <expression (IN) of dnum> ','
  [X ':=' ] <expression (IN) of dnum> ')'

```

A function with a return value of the data type dnum.

Related information

For information about	See
Mathematical instructions and functions	<i>Technical reference manual - RAPID Overview</i>
Arc tangent with only one argument	ATan - Calculates the arc tangent value on page 1160

2 Functions

2.15 BitAnd - Logical bitwise AND - operation on byte data

RobotWare Base

2.15 BitAnd - Logical bitwise AND - operation on byte data

Usage

BitAnd is used to execute a logical bitwise AND - operation on data types byte.

Basic examples

The following example illustrates the function BitAnd.

Example 1

```
VAR byte data1 := 38;  
VAR byte data2 := 34;  
VAR byte data3;  
  
data3 := BitAnd(data1, data2);
```

The logical bitwise AND - operation (see following figure) is executed on the data1 and data2. The result is returned to data3 (integer representation).

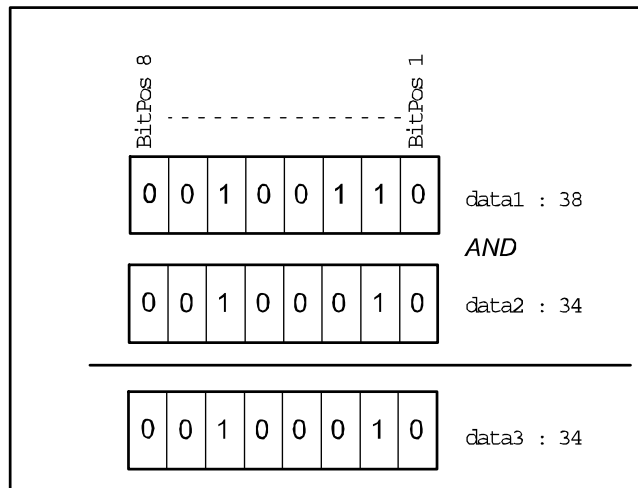

xx0500002454

Return value

Data type: byte

The result of the logical bitwise AND - operation in integer representation.

Arguments

BitAnd (BitData1 BitData2)

BitData1

Data type: byte

The bit data 1, in integer representation.

BitData2

Data type: byte

The bit data 2, in integer representation.

Continues on next page

Limitations

The range for a data type `byte` is 0 - 255.

Syntax

```
BitAnd '('
  [BitData1 ':=' ] <expression (IN) of byte> ','
  [BitData2 ':=' ] <expression (IN) of byte> ')'
```

A function with a return value of the data type `byte`.

Related information

For information about	See
Logical bitwise OR - operation on byte data	BitOr - Logical bitwise OR - operation on byte data on page 1180
Logical bitwise XOR - operation on byte data	BitXor - Logical bitwise XOR - operation on byte data on page 1188
Logical bitwise NEGATION - operation on byte data	BitNeg - Logical bitwise NEGATION - operation on byte data on page 1176
Other bit functions	<i>Technical reference manual - RAPID Overview</i>
<i>Advanced RAPID</i>	<i>Product specification - Controller software IRC5</i>

2 Functions

2.16 BitAndDnum - Logical bitwise AND - operation on dnum data

RobotWare Base

2.16 BitAndDnum - Logical bitwise AND - operation on dnum data

Usage

BitAndDnum is used to execute a logical bitwise AND - operation on data types dnum.

Basic examples

The following example illustrates the function BitAndDnum.

Example 1

```
VAR dnum data1 := 38;  
VAR dnum data2 := 35;  
VAR dnum data3;  
  
data3 := BitAndDnum(data1, data2);
```

The logical bitwise AND - operation (see figure below) will be executed on the data1 and data2. The result will be returned to data3 (integer representation).

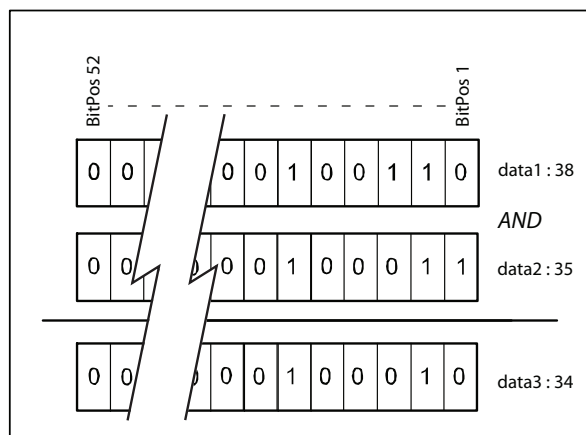

xx120000007

Return value

Data type: dnum

The result of the logical bitwise AND - operation in integer representation.

Arguments

```
BitAndDnum (Value1 Value2)
```

Value1

Data type: dnum

The first bit data value, in integer representation.

Value2

Data type: dnum

The second bit data value, in integer representation.

Continues on next page

Limitations

The range for a data type `dnum` is 0 - 4503599627370495.

Syntax

```
BitAndDnum '('
  [Value1 ':=' ] <expression (IN) of dnum> ','
  [Value2 ':=' ] <expression (IN) of dnum> ')'
```

A function with a return value of the data type `dnum`.

Related information

For information about	See
Logical bitwise AND - operation on <code>byte</code> data	BitAnd - Logical bitwise AND - operation on byte data on page 1164
Data type <code>dnum</code>	dnum - Double numeric values on page 1649
Logical bitwise OR - operation on <code>dnum</code> data	BitOrDnum - Logical bitwise OR - operation on dnum data on page 1182
Logical bitwise XOR - operation on <code>dnum</code> data	BitXOrDnum - Logical bitwise XOR - operation on dnum data on page 1190
Logical bitwise NEGATION - operation on <code>dnum</code> data	BitNegDnum - Logical bitwise NEGATION - operation on dnum data on page 1178
Other bit functions	<i>Technical reference manual - RAPID Overview</i>

2 Functions

2.17 BitCheck - Check if a specified bit in a byte data is set

RobotWare Base

2.17 BitCheck - Check if a specified bit in a byte data is set

Usage

BitCheck is used to check if a specified bit in a defined byte data is set to 1.

Basic examples

The following example illustrates the function BitCheck.

Example 1

```
CONST num parity_bit := 8;
VAR byte data1 := 130;

IF BitCheck(data1, parity_bit) = TRUE THEN
  ...
ELSE
  ...
ENDIF
```

Bit number 8 (parity_bit) in the variable data1 is checked, for example, if the specified bit is set to 1 in the variable data1 then this function will return to TRUE. Bit check of data type byte is illustrated in the following figure.

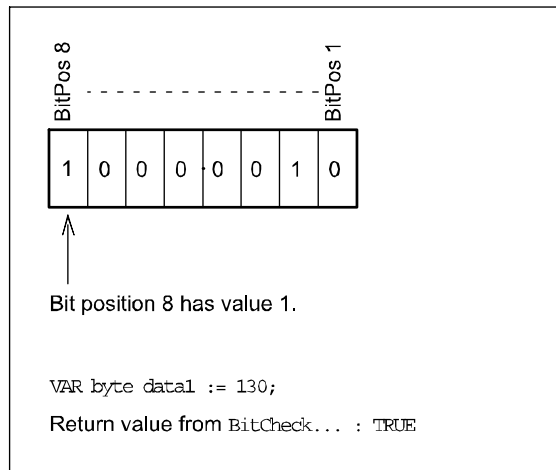

xx0500002442

Return value

Data type: bool

TRUE if the specified bit is set to 1, FALSE if the specified bit is set to 0.

Arguments

BitCheck (BitData BitPos)

BitData

Data type: byte

The bit data, in integer representation, to be checked.

Continues on next page

BitPos

Bit Position**Data type:** num

The bit position (1-8) in the BitData to be checked.

Limitations

The range for a data type byte is 0 - 255 decimal.

The bit position is valid from 1 - 8.

Syntax

```
BitCheck '('
  [BitData ':=' ] <expression (IN) of byte> ', '
  [BitPos ':=' ] <expression (IN) of num> ')'
```

A function with a return value of the data type bool.

Related information

For information about	See
Set a specified bit in a byte data	BitSet - Set a specified bit in a byte or dnum data on page 46
Clear a specified bit in a byte data	BitClear - Clear a specified bit in a byte or dnum data on page 43
Other bit functions	<i>Technical reference manual - RAPID Overview</i>
<i>Advanced RAPID</i>	<i>Product specification - Controller software IRC5</i>

2 Functions

2.18 BitCheckDnum - Check if a specified bit in a dnum data is set

RobotWare Base

2.18 BitCheckDnum - Check if a specified bit in a dnum data is set

Usage

`BitCheckDnum` is used to check if a specified bit in a defined `dnum` data is set to 1.

Basic examples

The following example illustrates the function `BitCheckDnum`.

Example 1

```
CONST num check_bit := 50;
VAR dnum data1 := 1688849860263956;

IF BitCheckDnum(data1, check_bit) = TRUE THEN
    ...
ELSE
    ...
ENDIF
```

Bit number 50 (`check_bit`) in the variable `data1` will be checked, for example, if the specified bit is 1 in the variable `data1` then this function will return to `TRUE`. Bit check of data type `dnum` is illustrated in the figure below.

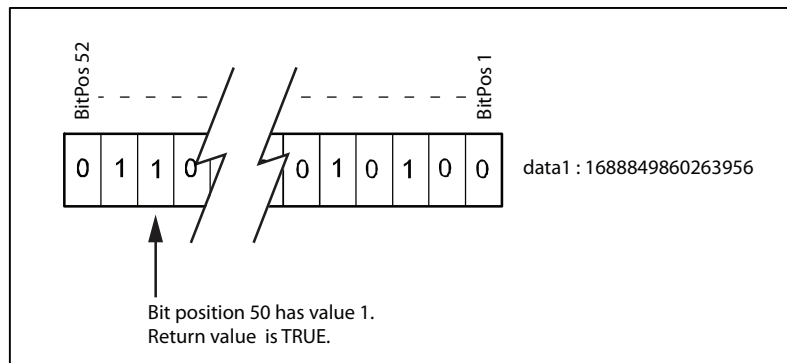

xx1200000016

Return value

Data type: `bool`

`TRUE` if the specified bit is set to 1, `FALSE` if the specified bit is set to 0.

Arguments

`BitCheckDnum (Value BitPos)`

Value

Data type: `dnum`

The bit data, in integer representation, to be checked.

BitPos

Bit Position

Data type: `num`

Continues on next page

2.18 BitCheckDnum - Check if a specified bit in a dnum data is set

RobotWare Base

Continued

The bit position (1-52) in `Value` to be checked.

Limitations

The range for a data type `dnum` is 0 - 4503599627370495 decimal.

The bit position is valid from 1 - 52.

Syntax

```
BitCheckDnum '('
  [Value ':=' ] <expression (IN) of dnum> ','
  [BitPos ':=' ] <expression (IN) of num> ')'

```

A function with a return value of the data type `bool`.

Related information

For information about	See
Check if a specified bit in a byte data is set	BitCheck - Check if a specified bit in a byte data is set on page 1168
Data type <code>dnum</code>	dnum - Double numeric values on page 1649
Set a specified bit in a byte or <code>dnum</code> data	BitSet - Set a specified bit in a byte or dnum data on page 46
Clear a specified bit in a byte or <code>dnum</code> data	BitClear - Clear a specified bit in a byte or dnum data on page 43
Other bit functions	Technical reference manual - RAPID Overview

2 Functions

2.19 BitLSh - Logical bitwise LEFT SHIFT - operation on byte

RobotWare Base

2.19 BitLSh - Logical bitwise LEFT SHIFT - operation on byte

Usage

BitLSh (*Bit Left Shift*) is used to execute a logical bitwise LEFT SHIFT-operation on data types byte.

Basic examples

The following example illustrates the function BitLSh.

Example 1

```
VAR num left_shift := 3;
VAR byte data1 := 38;
VAR byte data2;

data2 := BitLSh(data1, left_shift);
```

The logical bitwise LEFT SHIFT- operation will be executed on the data1 with 3 (left_shift) steps of left shift, and the result will be returned to data2 (integer representation).

The following figure shows logical bitwise LEFT SHIFT-operation.

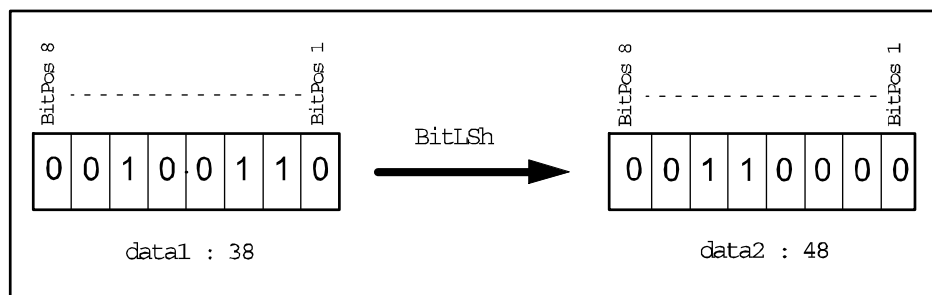

xx0500002457

Return value

Data type: byte

The result of the logical bitwise LEFT SHIFT-operation in integer representation.

The right bit cells will be filled up with 0-bits.

Arguments

BitLSh (BitData ShiftSteps)

BitData

Data type: byte

The bit data, in integer representation, to be shifted.

ShiftSteps

Data type: num

Number of the logical shifts (0 - 8) to be executed.

Use of 0 will return the value in the BitData argument.

Continues on next page

Limitations

The range for a data type `byte` is 0 - 255.

The `ShiftSteps` argument is valid from 1 - 8 according to one byte.

Syntax

```
BitLSh '('
  [BitData ':=' ] <expression (IN) of byte> ','
  [ShiftSteps ':=' ] <expression (IN) of num> ')'
```

A function with a return value of the data type `byte`.

Related information

For information about	See
Logical bitwise RIGHT SHIFT-operation on byte data	BitRSh - Logical bitwise RIGHT SHIFT - operation on byte on page 1184
Other bit functions	<i>Technical reference manual - RAPID Overview</i>
<i>Advanced RAPID</i>	<i>Product specification - Controller software IRC5</i>

2 Functions

2.20 BitLShDnum - Logical bitwise LEFT SHIFT - operation on dnum

RobotWare Base

2.20 BitLShDnum - Logical bitwise LEFT SHIFT - operation on dnum

Usage

`BitLShDnum` (*Bit Left Shift dnum*) is used to execute a logical bitwise LEFT SHIFT-operation on data types `dnum`.

Basic examples

The following example illustrates the function `BitLShDnum`.

See also [More examples on page 1175](#).

Example 1

```
VAR num left_shift := 2;
VAR dnum data1 := 2533274790395910;
VAR dnum data2;

data2 := BitLShDnum(data1, left_shift);
```

The logical bitwise LEFT SHIFT- operation will be executed on the `data1` with 2 (`left_shift`) steps of left shift, and the result will be returned to `data2` (integer representation).

The following figure shows logical bitwise LEFT SHIFT-operation.

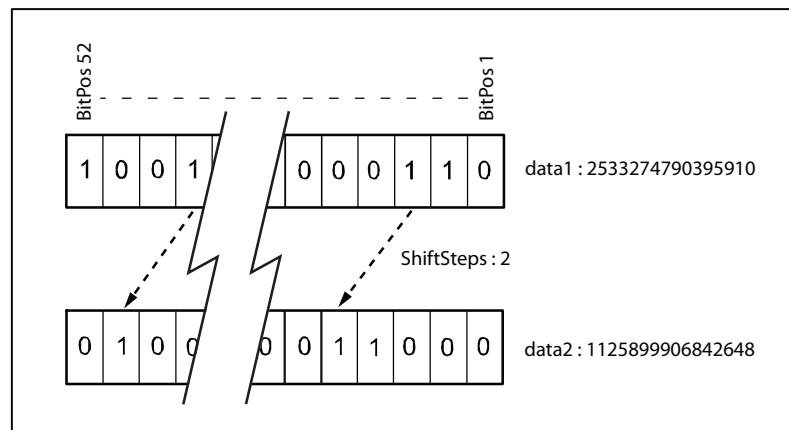

xx120000008

Return value

Data type: `dnum`

The result of the logical bitwise LEFT SHIFT-operation in integer representation.

The right bit cells will be filled up with 0-bits.

Arguments

`BitLShDnum` (Value ShiftSteps [`\Size`])

Value

Data type: `dnum`

The bit data, in integer representation, to be shifted.

Continues on next page

ShiftSteps

Data type: num

Number of the logical shifts (0 - 52) to be executed.

Use of 0 will return the value in the `Value` argument.

Size

Data type: num

The size (number of bits) that should be considered when doing the logical bitwise LEFT SHIFT-operation on argument `Value`. The size is valid from 1 - 52.

More examples

More examples of the function `BitLshDnum` are illustrated below.

Example 1

```
VAR dnum result;
VAR dnum data1:=221;
! Only consider the 8 lowest bits
result := BitLshDnum(data1, 4 \Size:=8);
TPWrite "" \Dnum:=result;
! Consider all 52 bits in the dnum datatype
result := BitLshDnum(data1, 4);
TPWrite "" \Dnum:=result;
```

The logical bitwise LEFT SHIFT- operation will be executed on the `data1`, and the result will be returned to `result` (integer representation). The first value to be written on the FlexPendant is 208. The second value to be written on the FlexPendant is 3536.

Limitations

The range for a data type `dnum` is 0 - 4503599627370495.

The `ShiftSteps` argument is valid from 1 - 52 since one `dnum` is 52 bits.

Syntax

```
BitLshDnum '('
  [Value ':=' ] <expression (IN) of dnum> ','
  [ShiftSteps ':=' ] <expression (IN) of num>
  ['\ ' Size ':=' ] < expression (IN) of num>
  ')'
```

A function with a return value of the data type `dnum`.

Related information

For information about	See
Logical bitwise LEFT SHIFT-operation on byte data	BitLSh - Logical bitwise LEFT SHIFT - operation on byte on page 1172
Data type <code>dnum</code>	dnum - Double numeric values on page 1649
Logical bitwise RIGHT SHIFT-operation on <code>dnum</code> data	BitRShDnum - Logical bitwise RIGHT SHIFT - operation on dnum on page 1186
Other bit functions	Technical reference manual - RAPID Overview

2 Functions

2.21 BitNeg - Logical bitwise NEGATION - operation on byte data

RobotWare Base

2.21 BitNeg - Logical bitwise NEGATION - operation on byte data

Usage

BitNeg (*Bit Negation*) is used to execute a logical bitwise NEGATION - operation (one's complement) on data types `byte`.

Basic examples

The following example illustrates the function BitNeg.

Example 1

```
VAR byte data1 := 38;  
VAR byte data2;  
  
data2 := BitNeg(data1);
```

The logical bitwise NEGATION - operation (see figure below) will be executed on the `data1`, and the result will be returned to `data2` (integer representation).

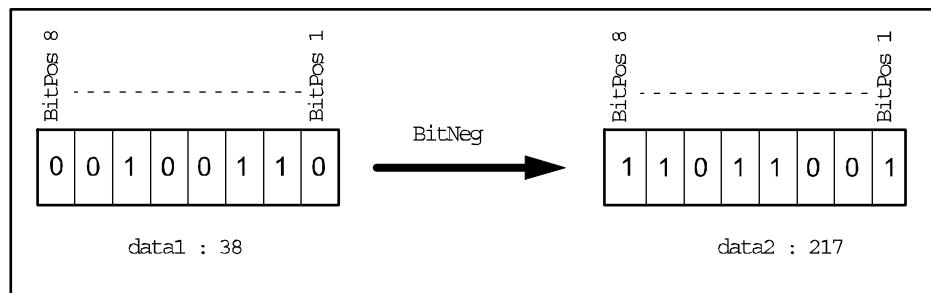

xx0500002456

Return value

Data type: `byte`

The result of the logical bitwise NEGATION - operation in integer representation.

Arguments

BitNeg (BitData)

BitData

Data type: `byte`

The byte data, in integer representation.

Limitations

The range for a data type `byte` is 0 - 255.

Syntax

```
BitNeg '('  
  [BitData ':='] <expression (IN) of byte>  
  ')'
```

A function with a return value of the data type `byte`.

Continues on next page

Related information

For information about	See
Logical bitwise AND - operation on byte data	BitAnd - Logical bitwise AND - operation on byte data on page 1164
Logical bitwise OR - operation on byte data	BitOr - Logical bitwise OR - operation on byte data on page 1180
Logical bitwise XOR - operation on byte data	BitXOr - Logical bitwise XOR - operation on byte data on page 1188
Other bit functions	<i>Technical reference manual - RAPID Overview</i>
<i>Advanced RAPID</i>	<i>Product specification - Controller software IRC5</i>

2 Functions

2.22 BitNegDnum - Logical bitwise NEGATION - operation on dnum data *RobotWare Base*

2.22 BitNegDnum - Logical bitwise NEGATION - operation on dnum data

Usage

`BitNegDnum` (*Bit Negation dnum*) is used to execute a logical bitwise NEGATION - operation (one's complement) on data types `dnum`.

Basic examples

The following example illustrates the function `BitNegDnum`.

See also [More examples on page 1179](#).

Example 1

```
VAR dnum data1 := 4;  
VAR dnum data2;  
  
data2 := BitNegDnum(data1);
```

The logical bitwise NEGATION - operation (see figure below) will be executed on the `data1`, and the result will be returned to `data2` (integer representation).

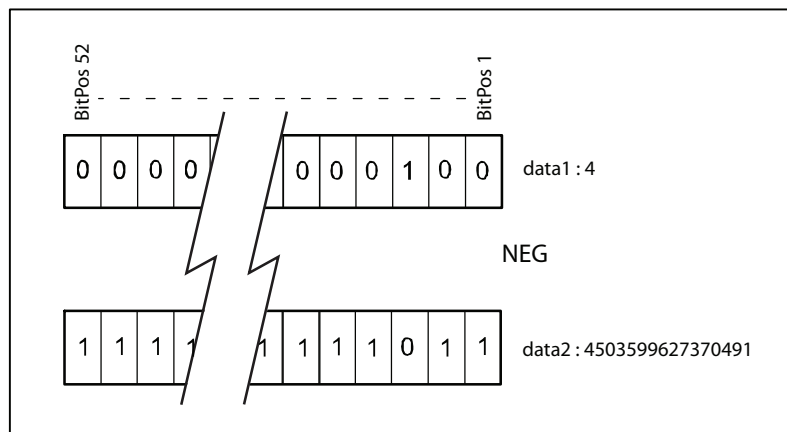

xx1200000012

Return value

Data type: `dnum`

The result of the logical bitwise NEGATION - operation in integer representation.

Arguments

```
BitNegDnum (Value [\Size])
```

Value

Data type: `dnum`

The `dnum` data, in integer representation.

Size

Data type: `num`

The size (number of bits) that should be considered when doing the logical bitwise NEGATION-operation on argument `Value`. The size is valid from 1 - 52.

Continues on next page

More examples

More examples of the function `BitNegDnum` are illustrated below.

Example 1

```
VAR dnum result;
VAR dnum data1:=38;
! Only consider the 16 lowest bits
result := BitNegDnum(data1 \Size:=16);
TPWrite "" \Dnum:=result;
! Consider all 52 bits in the dnum datatype
result := BitNegDnum(data1);
TPWrite "" \Dnum:=result;
```

The logical bitwise NEGATION - operation will be executed on the `data1`, and the result will be returned to `result` (integer representation). The first value to be written on the FlexPendant is 65497. The second value to be written on the FlexPendant is 4503599627370457.

Limitations

The range for a data type `dnum` is 0 - 4503599627370495.

Syntax

```
BitNegDnum '('
  [Value ':=' ] <expression (IN) of dnum>
  ['\Size ':=' < expression (IN) of num>]
  ')'
```

A function with a return value of the data type `dnum`.

Related information

For information about	See
Logical bitwise NEGATION - operation on byte data	BitNeg - Logical bitwise NEGATION - operation on byte data on page 1176
Data type <code>dnum</code>	dnum - Double numeric values on page 1649
Logical bitwise AND - operation on dnum data	BitAndDnum - Logical bitwise AND - operation on dnum data on page 1166
Logical bitwise OR - operation on dnum data	BitOrDnum - Logical bitwise OR - operation on dnum data on page 1182
Logical bitwise XOR - operation on dnum data	BitXOrDnum - Logical bitwise XOR - operation on dnum data on page 1190
Other bit functions	<i>Technical reference manual - RAPID Overview</i>

2 Functions

2.23 BitOr - Logical bitwise OR - operation on byte data

RobotWare Base

2.23 BitOr - Logical bitwise OR - operation on byte data

Usage

BitOr (*Bit inclusive Or*) is used to execute a logical bitwise OR-operation on data types byte.

Basic examples

The following example illustrates the function BitOr.

Example 1

```
VAR byte data1 := 39;  
VAR byte data2 := 162;  
VAR byte data3;  
  
data3 := BitOr(data1, data2);
```

The logical bitwise OR-operation will be executed on the data1 and data2, and the result will be returned to data3 (integer representation).

The following figure shows logical bitwise OR-operation.

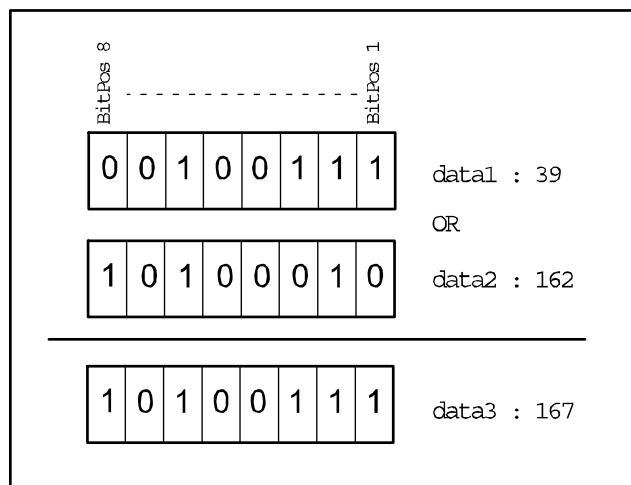

xx0500002458

Return value

Data type: byte

The result of the logical bitwise OR-operation in integer representation.

Arguments

```
BitOr (BitData1 BitData2)
```

BitData1

Data type: byte

The bit data 1, in integer representation.

BitData2

Data type: byte

Continues on next page

The bit data 2, in integer representation.

Limitations

The range for a data type `byte` is 0 - 255.

Syntax

```
BitOr '('
  [BitData1 ':='] <expression (IN) of byte> ','
  [BitData2 ':='] <expression (IN) of byte>
  ')'
```

A function with a return value of the data type `byte`.

Related information

For information about	See
Logical bitwise AND - operation on byte data	BitAnd - Logical bitwise AND - operation on byte data on page 1164
Logical bitwise XOR - operation on byte data	BitXOr - Logical bitwise XOR - operation on byte data on page 1188
Logical bitwise NEGATION - operation on byte data	BitNeg - Logical bitwise NEGATION - operation on byte data on page 1176
Other bit functions	<i>Technical reference manual - RAPID Overview</i>
<i>Advanced RAPID</i>	<i>Product specification - Controller software IRC5</i>

2 Functions

2.24 BitOrDnum - Logical bitwise OR - operation on dnum data

RobotWare Base

2.24 BitOrDnum - Logical bitwise OR - operation on dnum data

Usage

`BitOrDnum` (*Bit inclusive Or dnum*) is used to execute a logical bitwise OR-operation on data types `dnum`.

Basic examples

The following example illustrates the function `BitOrDnum`.

Example 1

```
VAR dnum data1 := 39;  
VAR dnum data2 := 162;  
VAR dnum data3;  
  
data3 := BitOrDnum(data1, data2);
```

The logical bitwise OR-operation will be executed on the `data1` and `data2`, and the result will be returned to `data3` (integer representation).

The following figure shows logical bitwise OR-operation.

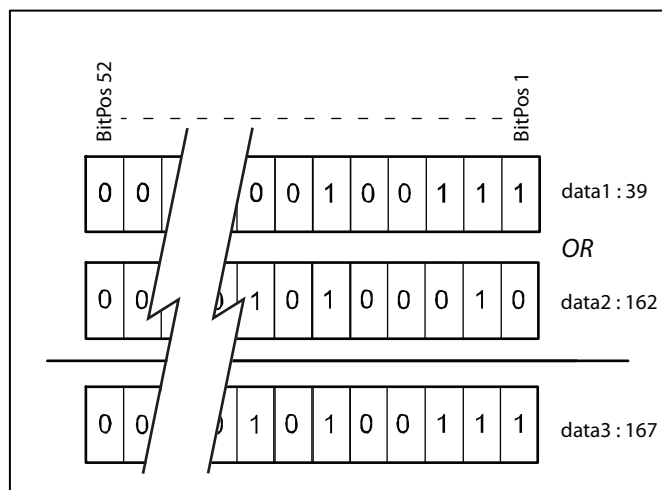

xx120000011

Return value

Data type: `dnum`

The result of the logical bitwise OR-operation in integer representation.

Arguments

`BitOrDnum` (`Value1` `Value2`)

`Value1`

Data type: `dnum`

The first bit data value, in integer representation.

`Value2`

Data type: `dnum`

The second bit data value, in integer representation.

Continues on next page

Limitations

The range for a data type `dnum` is 0 - 4503599627370495.

Syntax

```
BitOrDnum '('
  [Value1 ':='] <expression (IN) of dnum> ','
  [Value2 ':='] <expression (IN) of dnum>
  ')'
```

A function with a return value of the data type `dnum`.

Related information

For information about	See
Logical bitwise OR - operation on byte data	BitOr - Logical bitwise OR - operation on byte data on page 1180
Data type <code>dnum</code>	dnum - Double numeric values on page 1649
Logical bitwise AND - operation on <code>dnum</code> data	BitAndDnum - Logical bitwise AND - operation on dnum data on page 1166
Logical bitwise XOR - operation on <code>dnum</code> data	BitXOrDnum - Logical bitwise XOR - operation on dnum data on page 1190
Logical bitwise NEGATION - operation on <code>dnum</code> data	BitNegDnum - Logical bitwise NEGATION - operation on dnum data on page 1178
Other bit functions	Technical reference manual - RAPID Overview

2 Functions

2.25 BitRSh - Logical bitwise RIGHT SHIFT - operation on byte

RobotWare Base

2.25 BitRSh - Logical bitwise RIGHT SHIFT - operation on byte

Usage

BitRSh (*Bit Right Shift*) is used to execute a logical bitwise RIGHT SHIFT-operation on data types byte.

Basic examples

The following example illustrates the function BitRSh.

Example 1

```
VAR num right_shift := 3;
VAR byte data1 := 38;
VAR byte data2;

data2 := BitRSh(data1, right_shift);
```

The logical bitwise RIGHT SHIFT-operation will be executed on the data1 with 3 (right_shift) steps of right shift, and the result will be returned to data2 (integer representation)

The following figure shows logical bitwise RIGHT SHIFT-operation.

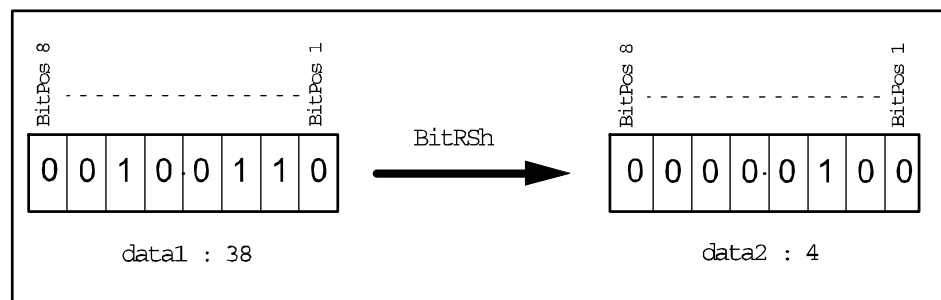

xx0500002455

Return value

Data type: byte

The result of the logical bitwise RIGHT SHIFT-operation in integer representation. The left bit cells will be filled up with 0-bits.

Arguments

BitRSh (BitData ShiftSteps)

BitData

Data type: byte

The bit data, in integer representation, to be shifted.

ShiftSteps

Data type: num

Number of the logical shifts (0 - 8) to be executed.

Use of 0 will return the value in the BitData argument.

Continues on next page

Limitations

The range for a data type `byte` is 0 - 255.

The `ShiftSteps` argument is valid from 1 - 8 according to one byte.

Syntax

```
BitRSh '('
  [BitData ':='] <expression (IN) of byte> ','
  [ShiftSteps ':='] <expression (IN) of num>
  ')'
```

A function with a return value of the data type `byte`.

Related information

For information about	See
Logical bitwise LEFT SHIFT-operation on byte data	BitLSh - Logical bitwise LEFT SHIFT - operation on byte on page 1172
Other bit functions	<i>Technical reference manual - RAPID Overview</i>
<i>Advanced RAPID</i>	<i>Product specification - Controller software IRC5</i>

2 Functions

2.26 BitRShDnum - Logical bitwise RIGHT SHIFT - operation on dnum

RobotWare Base

2.26 BitRShDnum - Logical bitwise RIGHT SHIFT - operation on dnum

Usage

BitRShDnum (*Bit Right Shift dnum*) is used to execute a logical bitwise RIGHT SHIFT-operation on data types dnum.

Basic examples

The following example illustrates the function BitRShDnum.

Example 1

```
VAR num right_shift := 3;
VAR dnum data1 := 2251799813685304;
VAR dnum data2;

data2 := BitRShDnum(data1, right_shift);
```

The logical bitwise RIGHT SHIFT-operation will be executed on the data1 with 3 (right_shift) steps of right shift, and the result will be returned to data2 (integer representation)

The following figure shows logical bitwise RIGHT SHIFT-operation.

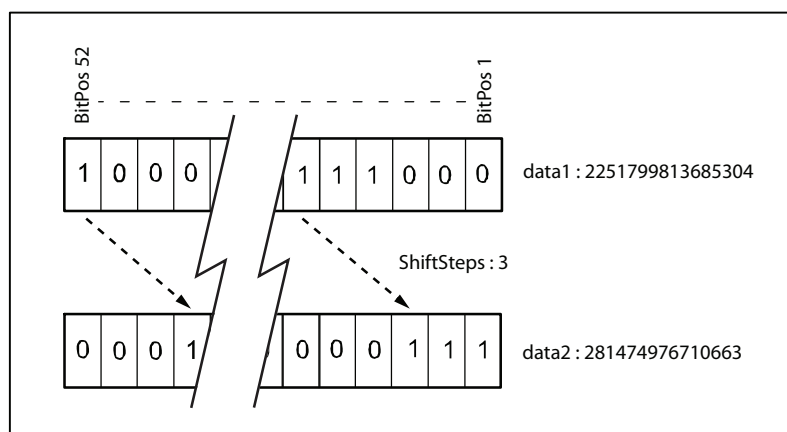

Return value

Data type: dnum

The result of the logical bitwise RIGHT SHIFT-operation in integer representation. The left bit cells will be filled up with 0-bits.

Arguments

BitRShDnum (Value ShiftSteps)

Value

Data type: dnum

The bit data, in integer representation, to be shifted.

ShiftSteps

Data type: num

Continues on next page

Number of the logical shifts (0 - 52) to be executed.

Use of 0 will return the value in the `Value` argument.

Limitations

The range for a data type `dnum` is 0 - 4503599627370495.

The `ShiftSteps` argument is valid from 1 - 52 since one `dnum` is 52 bits.

Syntax

```
BitRShDnum '('
  [Value ':=' ] <expression (IN) of dnum> ','
  [ShiftSteps ':=' ] <expression (IN) of num>
  ')'
```

A function with a return value of the data type `dnum`.

Related information

For information about	See
Logical bitwise RIGHT SHIFT-operation on byte data	BitRSh - Logical bitwise RIGHT SHIFT - operation on byte on page 1184
Data type <code>dnum</code>	dnum - Double numeric values on page 1649
Logical bitwise LEFT SHIFT-operation on <code>dnum</code> data	BitLShDnum - Logical bitwise LEFT SHIFT - operation on dnum on page 1174
Other bit functions	<i>Technical reference manual - RAPID Overview</i>

2 Functions

2.27 BitXOr - Logical bitwise XOR - operation on byte data

RobotWare Base

2.27 BitXOr - Logical bitwise XOR - operation on byte data

Usage

BitXOr (*Bit exclusive Or*) is used to execute a logical bitwise XOR-operation on data types byte.

Basic examples

The following example illustrates the function BitXOr.

Example 1

```
VAR byte data1 := 39;  
VAR byte data2 := 162;  
VAR byte data3;  
  
data3 := BitXOr(data1, data2);
```

The logical bitwise XOR -operation will be executed on the data1 and data2, and the result will be returned to data3 (integer representation).

The following figure shows logical bitwise XOR-operation.

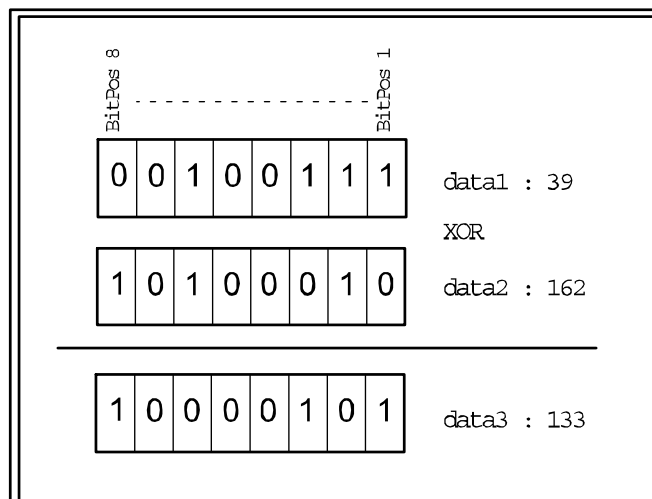

xx0500002459

Return value

Data type: byte

The result of the logical bitwise XOR-operation in integer representation.

Arguments

BitXOr (BitData1 BitData2)

BitData1

Data type: byte

The bit data 1, in integer representation.

BitData2

Data type: byte

Continues on next page

The bit data 2, in integer representation.

Limitations

The range for a data type `byte` is 0 - 255.

Syntax

```
BitXOr '('
  [BitData1 ':=' ] <expression (IN) of byte> ','
  [BitData2 ':=' ] <expression (IN) of byte>
  ')'
```

A function with a return value of the data type `byte`.

Related information

For information about	See
Logical bitwise AND - operation on byte data	BitAnd - Logical bitwise AND - operation on byte data on page 1164
Logical bitwise OR - operation on byte data	BitOr - Logical bitwise OR - operation on byte data on page 1180
Logical bitwise NEGATION - operation on byte data	BitNeg - Logical bitwise NEGATION - operation on byte data on page 1176
Other bit functions	<i>Technical reference manual - RAPID Overview</i>
<i>Advanced RAPID</i>	<i>Product specification - Controller software IRC5</i>

2 Functions

2.28 BitXOrDnum - Logical bitwise XOR - operation on dnum data

RobotWare Base

2.28 BitXOrDnum - Logical bitwise XOR - operation on dnum data

Usage

`BitXOrDnum` (*Bit exclusive Or dnum*) is used to execute a logical bitwise XOR-operation on data types `dnum`.

Basic examples

The following example illustrates the function `BitXOrDnum`.

Example 1

```
VAR dnum data1 := 39;  
VAR dnum data2 := 162;  
VAR dnum data3;  
  
data3 := BitXOrDnum(data1, data2);
```

The logical bitwise XOR-operation will be executed on the `data1` and `data2`, and the result will be returned to `data3` (integer representation).

The following figure shows logical bitwise XOR-operation.

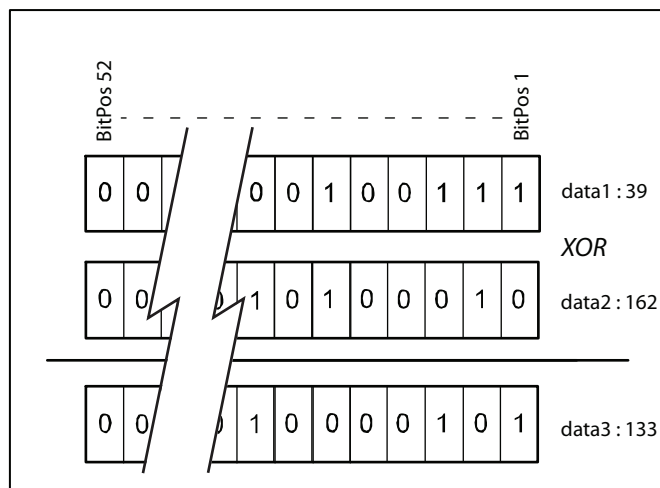

xx1200000010

Return value

Data type: `dnum`

The result of the logical bitwise XOR-operation in integer representation.

Arguments

`BitXOrDnum (Value1 Value2)`

Value1

Data type: `dnum`

The first bit data value, in integer representation.

Value2

Data type: `dnum`

Continues on next page

The second bit data value, in integer representation.

Limitations

The range for a data type `dnum` is 0 - 4503599627370495.

Syntax

```
BitXOrDnum '('
  [Value1 ':='] <expression (IN) of dnum> ','
  [Value2 ':='] <expression (IN) of dnum>
  ')'
```

A function with a return value of the data type `dnum`.

Related information

For information about	See
Logical bitwise XOR - operation on byte data	BitXOr - Logical bitwise XOR - operation on byte data on page 1188
Data type <code>dnum</code>	dnum - Double numeric values on page 1649
Logical bitwise AND - operation on dnum data	BitAndDnum - Logical bitwise AND - operation on dnum data on page 1166
Logical bitwise OR - operation on dnum data	BitOrDnum - Logical bitwise OR - operation on dnum data on page 1182
Logical bitwise NEGATION - operation on dnum data	BitNegDnum - Logical bitwise NEGATION - operation on dnum data on page 1178
Other bit functions	Technical reference manual - RAPID Overview

2 Functions

2.29 ByteToStr - Converts a byte to a string data

RobotWare Base

2.29 ByteToStr - Converts a byte to a string data

Usage

ByteToStr (*Byte To String*) is used to convert a byte into a string data with a defined byte data format.

Basic examples

The following example illustrates the function ByteToStr.

Example 1

```
VAR string con_data_buffer{5};  
VAR byte data1 := 122;
```

```
con_data_buffer{1} := ByteToStr(data1);
```

The content of the array component con_data_buffer{1} will be "122" after the ByteToStr ... function.

```
con_data_buffer{2} := ByteToStr(data1\Hex);
```

The content of the array component con_data_buffer{2} will be "7A" after the ByteToStr ... function.

```
con_data_buffer{3} := ByteToStr(data1\Okt);
```

The content of the array component con_data_buffer{3} will be "172" after the ByteToStr ... function.

```
con_data_buffer{4} := ByteToStr(data1\Bin);
```

The content of the array component con_data_buffer{4} will be "01111010" after the ByteToStr ... function.

```
con_data_buffer{5} := ByteToStr(data1\Char);
```

The content of the array component con_data_buffer{5} will be "z" after the ByteToStr ... function.

Return value

Data type: string

The result of the conversion operation with the following format:

Format	Characters	String length	Range
Dec	'0' - '9'	1-3	"0" - "255"
Hex	'0' - '9', 'A' - 'F'	2	"00" - "FF"
Okt	'0' - '7'	3	"000" - "377"
Bin	'0' - '1'	8	"00000000" - "11111111"
Char	Any ASCII char (*)	1	One ASCII char

(*) If it is a non-writable ASCII character then the return format will be RAPID character code format (for example, "\07" for BEL control character).

Arguments

```
ByteToStr (BitData [\Hex] | [\Okt] | [\Bin] | [\Char])
```

Continues on next page

BitData

Data type: byte

The bit data to be converted.

If the optional switch argument is omitted then the data will be converted in decimal (Dec) format.

[\Hex]

Hexadecimal

Data type: switch

The data will be converted in hexadecimal format.

[\Okt]

Octal

Data type: switch

The data will be converted in octal format.

[\Bin]

Binary

Data type: switch

The data will be converted in binary format.

[\Char]

Character

Data type: switch

The data will be converted in ASCII character format.

Limitations

The range for a data type byte is 0 to 255 decimal.

Syntax

```
ByteToStr '('
  [BitData ':='] <expression (IN) of byte>
  ['\ Hex ] | ['\ Okt] | ['\ Bin] | ['\ Char]
  ')'
```

A function with a return value of the data type string.

Related information

For information about	See
Convert a string to a byte data	StrToByte - Converts a string to a byte data on page 1500
Other bit (byte) functions	<i>Technical reference manual - RAPID Overview</i>
Other string functions	<i>Technical reference manual - RAPID Overview</i>

2 Functions

2.30 CalcJointT - Calculates joint angles from robtarget

RobotWare Base

2.30 CalcJointT - Calculates joint angles from robtarget

Usage

CalcJointT (*Calculate Joint Target*) is used to calculate joint angles of the robot axes and external axes from a specified `robtarget` data.

The input `robtarget` data should be specified in the same coordinate system as specified in argument for `Tool`, `WObj`, and at execution time active program displacement (`ProgDisp`) and external axes offset (`EOffs`). The returned `jointtarget` data is expressed in the calibration coordinate system.

If MultiMove application type semicoordinated or synchronized coordinated mode with the coordinated workobject, and is moved by some mechanical unit located in another program task, then the function `CalcJointT` can be used if:

- It is appropriate that the current position of the coordinated work object moved by the mechanical unit is used in the calculation (current user frame). All other data will be fetched from the RAPID program.
- The mechanical unit located in another program task is standing still.
- The argument `\UseCurWObjPos` is used.

Basic examples

The following examples illustrate the function `CalcJointT`.

Example 1

```
VAR jointtarget jointpos1;
CONST robtarget p1 := [...];
jointpos1 := CalcJointT(p1, tool1 \WObj:=wobj1);
```

The `jointtarget` value corresponding to the `robtarget` value `p1` is stored in `jointpos1`. The tool `tool1` and work object `wobj1` are used for calculating the joint angles `jointpos1`.

Example 2

```
VAR jointtarget jointpos2;
CONST robtarget p2 := [...];
jointpos2 := CalcJointT(\UseCurWObjPos, p2, tool2 \WObj:=orb1);
```

The `jointtarget` value corresponding to the `robtarget` value `p2` is stored in `jointpos2`. The tool `tool2` and work object `orb1` are used for calculating the joint angles `jointpos2`. The current position of the standing still manipulator `orb1` is not located in the same program task as the TCP robot but is used for the calculation.

Example 3

```
VAR jointtarget jointpos3;
CONST robtarget p3 := [...];
VAR errnum myerrnum;
jointpos3 := CalcJointT(p3, tool2 \WObj:=orb1
    \ErrorNumber:=myerrnum);
IF myerrnum = ERR_ROBLIMIT THEN
    TPWrite "Joint jointpos3 can not be reached.";
    TPWrite "jointpos3.robax.rax_1: "+ValToStr(jointpos3.robax.rax_1);
```

Continues on next page

2.30 CalcJointT - Calculates joint angles from robtarget

RobotWare Base

Continued

```

..
..
TPWrite "jointpos3.extax.eax_f"+ValToStr(jointpos3.extax.eax_f);
ELSEIF myerrnum = ERR_OUTSIDE_REACH THEN
TPWrite "Joint jointpos3 is outside reach.";
TPWrite "jointpos3.robax.rax_1: "+ValToStr(jointpos3.robax.rax_1);
..
..
TPWrite "jointpos3.extax.eax_f"+ValToStr(jointpos3.extax.eax_f);
ELSE
MoveAbsJ jointpos3, v100, fine, tool2 \WObj:=orb1;
ENDIF

```

The `jointtarget` value corresponding to the `robtarget` value `p3` is stored in `jointpos3`. If the position can be reached, it is used, otherwise the `jointtarget` value is written on the FlexPendant.

Return value

Data type: `jointtarget`

The angles in degrees for the axes of the robot on the arm side.

The values for the external axes, in mm for linear axes, in degrees for rotational axes.

The returned values are always related to the calibration position.

Arguments

```

CalcJointT ( [\UseCurWObjPos] Rob_target Tool [\WObj]
            [\ErrorNumber])

```

`[\UseCurWObjPos]`

Data type: `switch`

Use current position of the coordinated work object moved by the mechanical unit in another task for the calculation (current user frame). All other data is fetched from the RAPID program.

`Rob_target`

Data type: `robtarget`

The position of the robot and external axes in the outermost coordinate system, related to the specified tool and work object and at execution time active program displacement (`ProgDisp`) and/or external axes offset (`EOffs`).

`Tool`

Data type: `tooldata`

The tool used for calculation of the robot joint angles.

`[\WObj]`

Work Object

Data type: `wobjdata`

The work object (coordinate system) to which the robot position is related.

Continues on next page

2 Functions

2.30 CalcJointT - Calculates joint angles from robtarget

RobotWare Base

Continued

If this argument is omitted then the work object `wobj0` is used. This argument must be specified when using stationary tool, coordinated external axes, or conveyor.

[\ErrorNumber]

Error number

Data type: `errnum`

A variable (VAR or PERS) that will hold the error constant `ERR_ROBLIMIT` if at least one axis is outside the joint limits or if the limits are exceeded for at least one coupled joint, or `ERR_OUTSIDE_REACH` if the position (`robtarget`) is outside the robot's working area. If this optional argument is used and the variable is set to `ERR_ROBLIMIT` or `ERR_OUTSIDE_REACH` after the execution of the function, the return value will be a `jointtarget` value corresponding to the used `robtarget`. If this optional variable is omitted then the error handler will be executed and the `jointtarget` returned will not be updated if an axis is outside the working area or the limits are exceeded.

Program execution

The returned `jointtarget` is calculated from the input `robtarget`. If the argument `\UseCurWObjPos` is used, then the position that is used comes from the current position of the mechanical unit that controls the user frame. To calculate the robot joint angles, the specified `Tool`, `WObj` (including coordinated user frame), and the `ProgDisp` active at execution time are taken into consideration. To calculate the external axes position at the execution time, active `EOffs` is taken into consideration.

The calculation always selects the robot configuration according to the specified configuration data in the input `robtarget` data. Instructions `ConfL` and `ConfJ` do not affect this calculation principle. When wrist singularity is used, robot axis 4 will be set to 0 degrees.

If there is any active program displacement (`ProgDisp`) and/or external axis offset (`EOffs`) at the time the `robtarget` is stored then the same program displacement and/or external axis offset must be active when `CalcJointT` is executed.

Error handling

The following recoverable errors are generated and can be handled in an error handler. The system variable `ERRNO` will be set to:

Name	Cause of error
<code>ERR_ROBLIMIT</code>	The position is reachable, but at least one axis is outside the joint limits or the limits are exceeded for at least one coupled joint.
<code>ERR_OUTSIDE_REACH</code>	The position (<code>robtarget</code>) is outside the robot's working range.
<code>ERR_WOBJ_MOVING</code>	The mechanical unit that controls the work object (user frame) isn't standing still at execution time of <code>CalcJointT</code> <code>\UseCurWObjPos</code> .

Continues on next page

Limitation

If a coordinate frame is used then the coordinated unit has to be activated before using `CalcJointT`.

The mechanical unit that controls the user frame in the work object must normally be available in the same program task as the TCP robot which executes `CalcJointT`.

Normally `CalcJointT` uses `robtarget`, `tooldata`, and `wobjdata` from the RAPID program to calculate `jointtarget`. For coordinated workobjects, the position of the mechanical unit is given as external axes position in the `robtarget`. That is not the case if the mechanical unit is controlled by another program task (MultiMove system) or the mechanical unit is not controlled by the control system (Conveyor). For the MultiMove System but not for the conveyor it is possible to use the argument `\UseCurWObjPos` if the mechanical unit is standing still at the execution time of `CalcJointT`.

Syntax

```
CalcJointT '('
  [ '\UseCurWObjPos ',' ]
  [ Rob_target ':='] <expression (IN) of robtarget> ','
  [ Tool ':='] <persistent (PERS) of tooldata>
  [ '\ WObj ':='] <persistent (PERS) of wobjdata>
  [ '\ ErrorNumber ':='] <variable or persistent (INOUT) of errnum>
  ')'
```

A function with a return value of the data type `jointtarget`.

Related information

For information about	See
Calculate <code>robtarget</code> from <code>jointtarget</code>	CalcRobT - Calculates robtarget from jointtarget on page 1198
Definition of position	robtarget - Position data on page 1734
Definition of joint position	jointtarget - Joint position data on page 1679
Definition of tools	tooldata - Tool data on page 1776
Definition of work objects	wobjdata - Work object data on page 1803
Coordinate systems	<i>Technical reference manual - RAPID Overview</i>
Program displacement coordinate system	PDispOn - Activates program displacement on page 540
External axis offset coordinate system	EOffsOn - Activates an offset for additional axes on page 191

2 Functions

2.31 CalcRobT - Calculates robtarget from jointtarget

RobotWare Base

2.31 CalcRobT - Calculates robtarget from jointtarget

Usage

CalcRobT (*Calculate Robot Target*) is used to calculate a `robtarget` data from a given `jointtarget` data.

This function returns a `robtarget` value with position (x, y, z), orientation (q1 ... q4), robot axes configuration, and external axes position.

The input `jointtarget` data should be specified in the calibration coordinate system.

The returned `robtarget` data is expressed in the outermost coordinate system. It takes the specified tool, work object, and at execution time active program displacement (`ProgDisp`) and external axis offset (`EOffs`) into consideration.

Basic examples

The following example illustrates the function CalcRobT.

Example 1

```
VAR robtarget p1;
CONST jointtarget jointpos1 := [...];

p1 := CalcRobT(jointpos1, tool1 \WObj:=wobj1);
```

The `robtarget` value corresponding to the `jointtarget` value `jointpos1` is stored in `p1`. The tool `tool1` and work object `wobj1` are used for calculating the position of `p1`.

Return value

Data type: `robtarget`

The robot and external axes position is returned in data type `robtarget` and expressed in the outermost coordinate system. It takes the specified tool, work object, and at execution time active program displacement (`ProgDisp`) and external axes offset (`EOffs`) into consideration.

If there is no active `ProgDisp` then the robot position is expressed in the object coordinate system. If there are no active `EOffs` then the external axis position is expressed in the calibration coordinate system.

Arguments

```
CalcRobT( Joint_target Tool [\WObj] )
```

`Joint_target`

Data type: `jointtarget`

The joint position for the robot axes and external axes related to the calibration coordinate system.

`Tool`

Data type: `tooldata`

The tool used for calculation of the robot position.

Continues on next page

[\wObj]

Work Object**Data type:** wobjdata

The work object (coordinate system) to which the robot position returned by the function is related.

If this argument is omitted the work object wobj0 is used. This argument must be specified when using stationary tool, coordinated external axes, or conveyor.

Program execution

The returned `robtargt` is calculated from the input `jointtargt`. To calculate the cartesian robot position the specified `Tool`, `WObj` (including coordinated user frame), and at the execution time active `ProgDisp`, are taken into consideration.

To calculate the external axes position, the `EOfFs` active at execution time is also taken into consideration.

Limitation

If a coordinate frame is used then the coordinated unit has to be activated before using `CalcRobT`. The coordinated unit also has to be situated in the same task as the robot.

Syntax

```
CalcRobT '('
  [Joint_target ':=' ] <expression (IN) of jointtargt> ','
  [Tool ':=' ] <persistent (PERS) of tooldata>
  ['\ ' WObj ':=' <persistent (PERS) of wobjdata> ] ')'
```

A function with a return value of the data type `robtargt`.

Related information

For information about	See
Calculate jointtargt from robtargt	CalcJointT - Calculates joint angles from robtargt on page 1194
Definition of position	robtargt - Position data on page 1734
Definition of joint position	jointtargt - Joint position data on page 1679
Definition of tools	tooldata - Tool data on page 1776
Definition of work objects	wobjdata - Work object data on page 1803
Coordinate systems	<i>Technical reference manual - RAPID Overview</i>
Program displacement coordinate system	PDispOn - Activates program displacement on page 540
External axes offset coordinate system	EOffsOn - Activates an offset for additional axes on page 191

2 Functions

2.32 CalcRotAxFrameZ - Calculate a rotational axis frame

RobotWare Base

2.32 CalcRotAxFrameZ - Calculate a rotational axis frame

Usage

`CalcRotAxFrameZ` (*Calculate Rotational Axis Frame with positive Z-point*) is used to calculate the user coordinate system of a mechanical unit that is of the type rotational axis. This function is to be used when the master robot and the additional axis are located in different RAPID tasks. If they are in the same task then the function `CalcRotAxisFrame` should be used.

Description

The definition of a user frame for a rotational external axis requires that the turntable (or similar mechanical structure) on the external axis has a marked reference point. Moreover, the TCP robot's base frame and TCP must be calibrated. The calibration procedure consists of a number of positions for the robot's TCP on the reference point when the turntable is rotated to different angles. A positioning of the robot TCP in the positive z direction is also needed. For definition of points for a rotational axis, see the figure below.

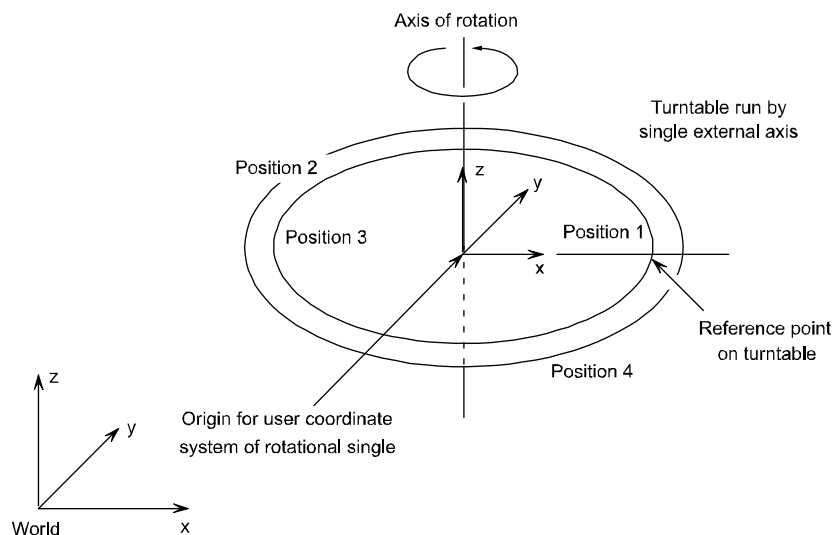

xx0500002468

The user coordinate system for the rotational axis has its origin in the center of the turntable. The z direction coincides with the axis of rotation and the x axis goes through the reference point.

Continues on next page

The figure below shows the user coordinate system for two different positions of the turntable (turntable seen from above).

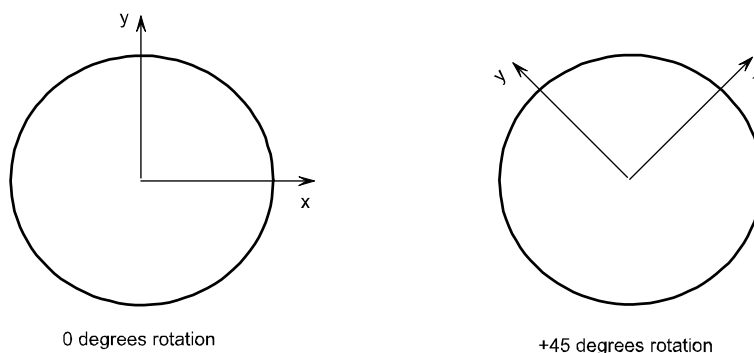

xx0500002469

Basic examples

The following example illustrates the function CalcRotAxFrameZ.

Example 1

```

CONST robtarget pos1 := [...];
CONST robtarget pos2 := [...];
CONST robtarget pos3 := [...];
CONST robtarget pos4 := [...];
CONST robtarget zpos;
VAR robtarget targetlist{10};
VAR num max_err := 0;
VAR num mean_err := 0;
VAR pose resFr:= [...];
PERS tooldata tMyTool:= [...];

! Instructions for creating/ModPos pos1 - pos4 with TCP pointing
! at the turntable.
MoveJ pos1, v10, fine, tMyTool;
MoveJ pos2, v10, fine, tMyTool;
MoveJ pos3, v10, fine, tMyTool;
MoveJ pos4, v10, fine, tMyTool;

! Instruction for creating/ModPos zpos with TCP pointing at a point
! in positive z direction
MoveJ zpos, v10, fine, tMyTool;

! Add the targets to the array
targetlist{1}:= pos1;
targetlist{2}:= pos2;
targetlist{3}:= pos3;
targetlist{4}:= pos4;

resFr:=CalcRotAxFrameZ(targetlist, 4, zpos, max_err, mean_err);

! Update the system parameters.

```

Continues on next page

2 Functions

2.32 CalcRotAxFrameZ - Calculate a rotational axis frame

RobotWare Base

Continued

```
IF (max_err < 1.0) AND (mean_err < 0.5) THEN
  WriteCfgData "/MOC/SINGLE/STN_1", "base_frame_pos_x",
    resFr.trans.x/1000;
  WriteCfgData "/MOC/SINGLE/STN_1", "base_frame_pos_y",
    resFr.trans.y/1000;
  WriteCfgData "/MOC/SINGLE/STN_1", "base_frame_pos_z",
    resFr.trans.z/1000;
  WriteCfgData "/MOC/SINGLE/STN_1", "base_frame_orient_u0",
    resFr.rot.q1;
  WriteCfgData "/MOC/SINGLE/STN_1", "base_frame_orient_u1",
    resFr.rot.q2;
  WriteCfgData "/MOC/SINGLE/STN_1", "base_frame_orient_u2",
    resFr.rot.q3;
  WriteCfgData "/MOC/SINGLE/STN_1", "base_frame_orient_u3",
    resFr.rot.q4;
  TPReadFK reg1,"Warmstart required for calibration to take
    effect.", stEmpty, stEmpty, stEmpty, stEmpty,"OK";
  WarmStart;
ENDIF
```

Four positions, `pos1 - pos4`, are created/modposed so that the robot's tool `tMyTool` points to the same reference point on the external axis `STN_1` but with different external axis rotations. Position, `zpos`, is created/modposed so that the robot's tool `tMyTool` points in the positive `z` direction according to the definition of the positive `z`-direction of an external rotational mechanical unit. Using the definition of the positive `z`-direction of an external rotational mechanical unit, see [Description on page 1200](#). The points are then used for calculating the external axis base frame, `resFr`, in relation to the world coordinate system. Finally, the frame is written to the configuration file and a `WarmStart` instruction is executed to let the change take effect.



Note

Definition of the positive `z`-direction of an external rotational mechanical unit:

Let the right hand's fingers coincide with the positive rotation axis of the rotational axis. The direction of the thumb then defines the positive `z`-direction. See the following figure.

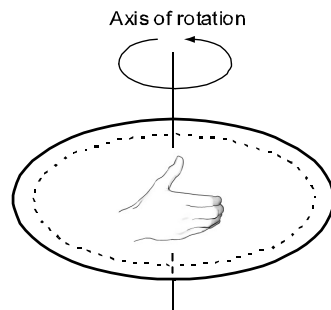

xx0500002472

Continues on next page

Return value

Data type: pose

The calculated frame.

Arguments

```
CalcRotAxFrameZ (TargetList TargetsInList PositiveZPoint
                MaxErrMeanErr)
```

TargetList

Data type: robtarget

Array of robtargets holding the positions defined by pointing out the turntable. Minimum number of robtargets is 4, maximum 10.

TargetsInList

Data type: num

Number of robtargets in an array.

PositiveZPoint

Data type: robtarget

robtarget holding the position defined by pointing out a point in the positive z direction. Using the definition of the positive z-direction of an external rotational mechanical unit, see [Description on page 1200](#).

MaxErr

Maximum Error

Data type: num

The estimated maximum error in mm.

MeanErr

Mean Error

Data type: num

The estimated mean error in mm.

Error handling

The following recoverable errors are generated and can be handled in an error handler. The system variable ERRNO will be set to:

Name	Cause of error
ERR_FRAME	The positions don't have the required relation or are not specified with enough accuracy.

Syntax

```
CalcRotAxFrameZ '('
  [TargetList ':=' ] <array {*} (IN) of robtarget> ','
  [TargetsInList ':=' ] <expression (IN) of num> ','
  [PositiveZPoint ':=' ] <expression (IN) of robtarget> ','
  [MaxErr ':=' ] <variable (VAR) of num> ','
  [MeanErr ':=' ] <variable (VAR) of num> ')'
```

Continues on next page

2 Functions

2.32 CalcRotAxFrameZ - Calculate a rotational axis frame

RobotWare Base

Continued

A function with a return value of the data type `pose`.

Related information

For information about	See
Mathematical instructions and functions	<i>Technical reference manual - RAPID Overview</i>

2.33 CalcRotAxisFrame - Calculate a rotational axis frame

Usage

`CalcRotAxisFrame` (*Calculate Rotational Axis Frame*) is used to calculate the user coordinate system of a mechanical unit that is of type rotational axis. This function is to be used when the master robot and the additional axis are located in the same RAPID task. If they are in different tasks the function `CalcRotAxFrameZ` should be used.

Description

The definition of a user frame for a rotational external axis requires that the turntable (or similar mechanical structure) on the external axis has a marked reference point. Moreover, the master robot's base frame and TCP must be calibrated. The calibration procedure consists of a number of positions for the robot's TCP on the reference point when the turntable is rotated to different angles. Definition of points for a rotational axis is illustrated in the figure below.

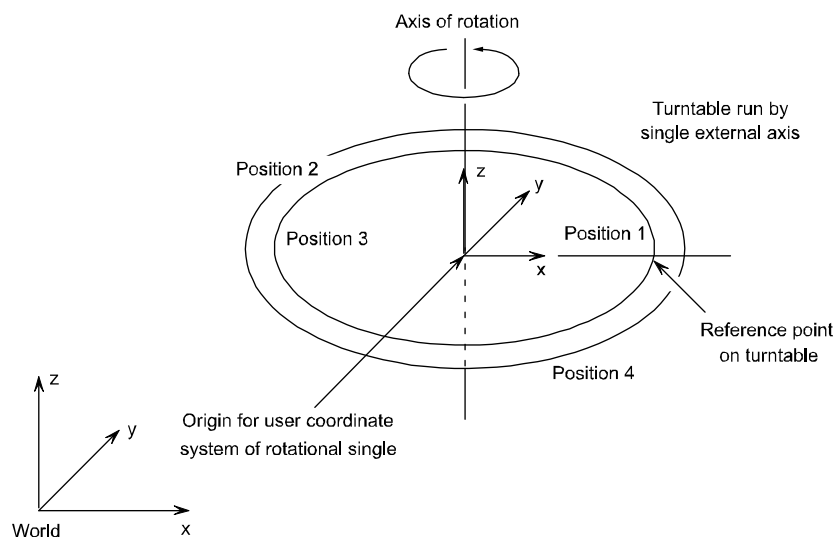

xx0500002468

The user coordinate system for the rotational axis has its origin in the center of the turntable. The z direction coincides with the axis of rotation and the x axis goes through the reference point.

Continues on next page

2 Functions

2.33 CalcRotAxisFrame - Calculate a rotational axis frame

RobotWare Base

Continued

The figure below shows the user coordinate system for two different positions of the turntable (turntable seen from above).

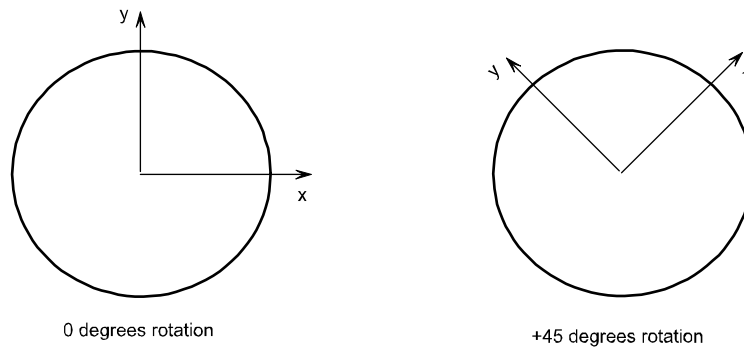

xx0500002469

Basic examples

The following example illustrates the function CalcRotAxisFrame.

Example 1

```
CONST robtarget pos1 := [...];
CONST robtarget pos2 := [...];
CONST robtarget pos3 := [...];
CONST robtarget pos4 := [...];
VAR robtarget targetlist{10};
VAR num max_err := 0;
VAR num mean_err := 0;
VAR pose resFr:= [...];
PERS tooldata tMyTool:= [...];

! Instructions needed for creating/ModPos pos1 - pos4 with TCP
! pointing at the turntable.
MoveJ pos1, v10, fine, tMyTool;
MoveJ pos2, v10, fine, tMyTool;
MoveJ pos3, v10, fine, tMyTool;
MoveJ pos4, v10, fine, tMyTool;

! Add the targets to the array
targetlist{1}:= pos1;
targetlist{2}:= pos2;
targetlist{3}:= pos3;
targetlist{4}:= pos4;

resFr:=CalcRotAxisFrame(STN_1 , targetlist, 4, max_err, mean_err);

! Update the system parameters.
IF (max_err < 1.0) AND (mean_err < 0.5) THEN
  WriteCfgData "/MOC/SINGLE/STN_1", "base_frame_pos_x",
    resFr.trans.x/1000;
  WriteCfgData "/MOC/SINGLE/STN_1", "base_frame_pos_y",
    resFr.trans.y/1000;
```

Continues on next page

2.33 CalcRotAxisFrame - Calculate a rotational axis frame

*RobotWare Base**Continued*

```

WriteCfgData "/MOC/SINGLE/STN_1", "base_frame_pos_z",
    resFr.trans.z/1000;
WriteCfgData "/MOC/SINGLE/STN_1", "base_frame_orient_u0",
    resFr.rot.q1;
WriteCfgData "/MOC/SINGLE/STN_1", "base_frame_orient_u1",
    resFr.rot.q2;
WriteCfgData "/MOC/SINGLE/STN_1", "base_frame_orient_u2",
    resFr.rot.q3;
WriteCfgData "/MOC/SINGLE/STN_1", "base_frame_orient_u3",
    resFr.rot.q4;
TPReadFK reg1,"Warmstart required for calibration to take
    effect.", stEmpty, stEmpty, stEmpty, stEmpty, "OK";
WarmStart;
ENDIF

```

Four positions, `pos1 - pos4`, are created/modposed so that the robot's tool `tMyTool` points to the same reference point on the external axis `STN_1` but with different external axis rotations. The points are then used for calculating the external axis base frame, `resFr`, in relation to the world coordinate system. Finally, the frame is written to the configuration file and a `WarmStart` instruction is executed to let the change take effect.

Return value**Data type:** `pose`

The calculated frame.

Arguments

```

CalcRotAxisFrame (MechUnit [\AxisNo] TargetList TargetsInList MaxErr
    MeanErr)

```

`MechUnit`**Mechanical Unit****Data type:** `mecunit`

Name of the mechanical unit to be calibrated.

`[\AxisNo]`**Data type:** `num`

Optional argument defining the axis number for which a frame should be determined. Default value is 1 applying to single rotational axis. For mechanical units with several axes, the axis number should be supplied with this argument.

`TargetList`**Data type:** `robtarget`

Array of `robtargets` holding the positions defined by pointing out the turntable. Minimum number of `robtargets` is 4, maximum is 10.

`TargetsInList`**Data type:** `num`Number of `robtargets` in an array.*Continues on next page*

2 Functions

2.33 CalcRotAxisFrame - Calculate a rotational axis frame

RobotWare Base

Continued

MaxErr

Maximum Error

Data type: num

The estimated maximum error in mm.

MeanErr

Mean Error

Data type: num

The estimated mean error in mm.

Error handling

The following recoverable errors are generated and can be handled in an error handler. The system variable `ERRNO` will be set to:

Name	Cause of error
ERR_FRAME	The positions don't have the required relation or are not specified with enough accuracy.

Syntax

```
CalcRotAxisFrame '('  
  [MechUnit ':='] <variable (VAR) of mecunit>  
  [\AxisNo ':=' <expression (IN) of num> ] ','  
  [TargetList ':='] <array {*} (IN) of robtargt> ','  
  [TargetsInList ':='] <expression (IN) of num> ','  
  [MaxErr ':='] <variable (VAR) of num> ','  
  [MeanErr ':='] <variable (VAR) of num> ')'
```

A function with a return value of the data type `pose`.

Related information

For information about	See
Mathematical instructions and functions	<i>Technical reference manual - RAPID Overview</i>

2.34 CamGetExposure - Get camera specific data

Usage

CamGetExposure (Camera Get Exposure) is a function that reads the current settings for a camera. With this function and with the instruction CamSetExposure it is possible to adapt the camera images depending on environment in runtime.

Basic examples

The following example illustrates the function CamGetExposure.

Example 1

```
VAR num exposuretime;  
...  
exposuretime:=CamGetExposure(mycamera \ExposureTime);  
IF exposuretime = 10 THEN  
    CamSetExposure mycamera \ExposureTime:=9.5;  
ENDIF
```

Order camera mycamera to change the exposure time to 9.5 ms if the current setting is 10 ms.

Return value

Data type: num

One of the settings exposure time, brightness, or contrast returned from the camera as a numerical value.

Arguments

```
CamGetExposure (Camera [\ExposureTime] | [\Brightness] |  
                [\Contrast])
```

Camera

Data type: cameradev

The name of the camera.

[\ExposureTime]

Data type: num

Returns the cameras exposure time. The value is in milliseconds (ms).

[\Brightness]

Data type: num

Returns the brightness setting of the camera

[\Contrast]

Data type: num

Returns the contrast setting of the camera

Continues on next page

2 Functions

2.34 CamGetExposure - Get camera specific data

Integrated Vision

Continued

Error handling

The following recoverable errors can be generated. The errors can be handled in an ERROR handler. The system variable `ERRNO` will be set to:

Name	Cause of error
<code>ERR_CAM_BUSY</code>	The camera is busy with some other request and cannot perform the current order.
<code>ERR_CAM_COM_TIMEOUT</code>	Communication error with camera. The camera is probably disconnected.
<code>ERR_CAM_NOT_ON_NETWORK</code>	The camera is not connected.

Syntax

```
CamGetExposure '('  
  [ Camera ':=' ] < variable (VAR) of cameradev >  
  ['\ExposureTime]  
  | ['\Brightness]  
  | ['\Contrast] ')'
```

A function with a return value of the data type `num`.

Related information

For information about	See
Integrated Vision	<i>Application manual - Integrated Vision</i>

2.35 CamGetLoadedJob - Get name of the loaded camera task

Usage

CamGetLoadedJob (*Camera Get Loaded Job*) is a function that reads the name of the current loaded job from the camera and returns it in a string.

Basic examples

The following example illustrates the function CamGetLoadedJob.

Example 1

```

VAR string currentjob;
...
currentjob:=CamGetLoadedJob(mycamera);
IF CurrentJob = "" THEN
  TPWrite "No job loaded in camera "+CamGetName(mycamera);
ELSE
  TPWrite "Job "+CurrentJob+" is loaded in camera "
    "+CamGetName(mycamera);
ENDIF

```

Write the loaded job name on the FlexPendant.

Return value

Data type: string

The current loaded job name for the specified camera.

Arguments

CamGetLoadedJob (Camera)

Camera

Data type: cameradev

The name of the camera.

Program execution

The function CamGetLoadedJob gets the current loaded job name from the camera. If no job is loaded into the camera, an empty string is returned.

Error handling

The following recoverable errors can be generated. The errors can be handled in an ERROR handler. The system variable ERRNO will be set to:

Name	Cause of error
ERR_CAM_BUSY	The camera is busy with some other request and cannot perform the current order.
ERR_CAM_COM_TIMEOUT	Communication error with camera. The camera is probably disconnected.
ERR_CAM_NOT_ON_NETWORK	The camera is not connected.

Continues on next page

2 Functions

2.35 CamGetLoadedJob - Get name of the loaded camera task

Integrated Vision

Continued

Syntax

```
CamGetLoadedJob '('  
  [ Camera ':=' ] < variable (VAR) of cameradev > ')'
```

A function with a return value of the data type `string`.

Related information

For information about	See
Integrated Vision	<i>Application manual - Integrated Vision</i>

2.36 CamGetMode - Get current mode of camera

Usage

CamGetMode returns the current mode of a camera.

Basic examples

The following example illustrates the function CamGetMode.

Example 1

```

VAR camerastatus curr_camerastatus;
...
curr_camerastatus:=CamGetMode(mycamera);
IF curr_camerastatus = CAMERA_DISCON THEN
  TPWrite "The camera is disconnected. Check cabling for camera
    "+CamGetName(mycamera);
ENDIF

```

Get current mode of the camera. If the camera is disconnected, write that on the FlexPendant.

Return value

Data type: camerastatus

The current status of the camera.

Only the predefined symbolic constants of type camerastatus can be used to check the state.

Arguments

CamGetMode(Camera)

Camera

Data type: cameradev

The camera which status is of interest.

Program execution

The function returns one of the following predefined states of camerastatus:

Syntax

```

CamGetMode '('
  [Camera ':=' ] <variable (VAR) of cameradev>')'

```

A function with a return value of the data type camerastatus.

Related information

For information about	See
Integrated Vision	<i>Application manual - Integrated Vision</i>
Data type camerastatus	camerastatus - Camera communication status on page 1608
Data type cameradev	cameradev - camera device on page 1607

2 Functions

2.37 CamGetName - Get the name of the used camera

Integrated Vision

2.37 CamGetName - Get the name of the used camera

Usage

CamGetName (Camera Get Name) is used to get the configured name of the camera.

Basic examples

The following example illustrates the function CamGetName.

Example 1

```
...
logcameraname camera1;
CamReqImage camera1;
...
logcameraname camera2;
CamReqImage camera2;
...
PROC logcameraname(VAR cameradev camdev)
  TPWrite "Now using camera: "+CamGetName(camdev);
ENDPROC
```

The procedure logs the name of the currently used camera to the FlexPendant.

Return value

Data type: string

The name of the currently used camera returned as a string.

Arguments

CamGetName(Camera)

Camera

Data type: cameradev

The name of the camera.

Syntax

```
CamGetName( '('
  [ Camera ':= ' ] < variable (VAR) of cameradev > ')'
```

A function with a return value of the data type string.

Related information

For information about	See
Integrated Vision	<i>Application manual - Integrated Vision</i>

2.38 CamNumberOfResults - Get number of available results

Usage

`CamNumberOfResults` (Camera Number of Results) is a function that reads the number of available vision results and returns it as a numerical value.

Basic examples

The following example illustrates the function `CamNumberOfResults`.

Example 1

```
VAR num foundparts;  
...  
CamReqImage mycamera;  
WaitTime 1;  
FoundParts := CamNumberOfResults(mycamera);  
TPWrite "Number of identified parts in the camera image:  
        "\Num:=foundparts;
```

Acquire an image. Wait for the image processing to complete, in this case 1 second. Read the number of identified parts and write it to the FlexPendant.

Return value

Data type: num

Returns the number of results in the collection for the specified camera.

Arguments

```
CamNumberOfResults (Camera [\SceneId])
```

Camera

Data type: cameradev

The name of the camera.

[\SceneId]

Scene Identification

Data type: num

The `SceneId` is an identifier that specifies from which image to read the number of identified parts.

Program execution

`CamNumberOfResults` is a function that reads the number of available vision results and returns it as a numerical value. Can be used to loop through all available results.

The function returns the queue level directly when the function is executed. If the function is executed directly after requesting an image, the result is often 0 because the camera has not yet finished processing the image.

Continues on next page

2 Functions

2.38 CamNumberOfResults - Get number of available results

Integrated Vision

Continued

Error handling

The following recoverable errors can be generated. The errors can be handled in an ERROR handler. The system variable `ERRNO` will be set to:

Name	Cause of error
<code>ERR_CAM_BUSY</code>	The camera is busy with some other request and cannot perform the current order.

Syntax

```
CamNumberOfResults '('  
  [ Camera ':= ' ] < variable (VAR) of cameradev >  
  [ '\SceneId ':= ' < expression (IN) of num > ] ')'
```

A function with a return value of the data type `num`.

Related information

For information about	See
Integrated Vision	<i>Application manual - Integrated Vision</i>

2.39 CapGetFailSigs - Get failed I/O signals

Usage

`CapGetFailSigs` is used to return the names on the signal or signals that failed during supervision of `CapL` or `CapC`.

If supervision of one or several signals fails during the process a recoverable error will be returned from the `CapL/CapC` instruction. To determine which signal or signals that failed, `CapGetFailSigs` can be used in an error handler for all cases of supervision errors.

Basic example

```
Stringcopied := CapGetFailSigs(Failstring);
```

`Stringcopied` is assigned the value `TRUE` if the copy succeeds, and `FALSE` if it fails.

`Failstring` contains the signals that failed as text. If no string could be copied the string `EMPTY` is returned.

Return value

Data type: `bool`

`TRUE` or `FALSE` depending on if the fail string is modified.

Arguments

```
CapGetFailSigs (ErrorNames)
```

ErrorNames

Data type: `string`

`CapGetFailSigs` requires a string variable as input parameter.

Limitations

If many signals in a supervision list failed at the same time, only three of them are reported with `CapGetFailSigs`.

Syntax

```
CapGetFailSigs '('  
[ErrorNames ':='] < variable (INOUT) of string >')'
```

A function with a return value of the data type `bool`.

Related information

For information about	See
<i>Continuous Application Platform</i>	<i>Application manual - Continuous Application Platform</i>
<code>InitSuperv</code>	InitSuperv - Reset all supervision for CAP on page 282
<code>SetupSuperv</code>	SetupSuperv - Setup conditions for signal supervision in CAP on page 718

Continues on next page

2 Functions

2.39 CapGetFailSigs - Get failed I/O signals

Continuous Application Platform (CAP)

Continued

For information about	See
RemoveSuperv	RemoveSuperv - Remove condition for one signal on page 605

2.40 CDate - Reads the current date as a string

Usage

CDate (*Current Date*) is used to read the current system date.

This function can be used to present the current date to the operator on the FlexPendant display or to paste the current date into a text file that the program writes to.

Basic examples

The following example illustrates the function CDate.

See also [More examples on page 1219](#).

Example 1

```
VAR string date;
date := CDate();
```

The current date is stored in the variable `date`.

Return value

Data type: `string`

The current date in a string.

The standard date format is “year-month-day”, for example, “1998-01-29”.

More examples

More examples of the function CDate are illustrated below.

Example 1

```
VAR string date;
date := CDate();
TPWrite "The current date is: "+date;
Write logfile, date;
```

The current date is written to the FlexPendant display and into a text file.

Syntax

```
CDate '(' ' ' )'
```

A function with a return value of the type `string`.

Related information

For information about	See
Time instructions	<i>Technical reference manual - RAPID Overview</i>
Setting the system clock	<i>Operating manual - IRC5 with FlexPendant</i>

2 Functions

2.41 CJointT - Reads the current joint angles

RobotWare Base

2.41 CJointT - Reads the current joint angles

Usage

`CJointT` (*Current Joint Target*) is used to read the current angles of the robot axes and external axes.

Basic examples

The following example illustrates the function `CJointT`.

See also [More examples on page 1221](#).

Example 1

```
VAR jointtarget joints;  
joints := CJointT();
```

The current angles of the axes for a robot and external axes are stored in `joints`.

Return value

Data type: `jointtarget`

The current angles in degrees for the axes of the robot on the arm side.

The current values for the external axes, in mm for linear axes, in degrees for rotational axes.

The returned values are related to the calibration position.

Arguments

```
CJointT ([\TaskRef] | [\TaskName])
```

`[\TaskRef]`

Task Reference

Data type: `taskid`

The program task identity from which the `jointtarget` should be read.

For all program tasks in the system, predefined variables of the data type `taskid` will be available. The variable identity will be "taskname"+"Id", for example, for the `T_ROB1` task, and the variable identity will be `T_ROB1Id`.

`[\TaskName]`

Data type: `string`

The program task name from which the `jointtarget` should be read.

If none of the arguments `\TaskRef` or `\TaskName` are specified then the current task is used.

Error handling

The following recoverable errors are generated and can be handled in an error handler. The system variable `ERRNO` will be set to:

Name	Cause of error
<code>ERR_TASKNAME</code>	The program task name in argument <code>\TaskName</code> cannot be found in the system.

Continues on next page

Name	Cause of error
ERR_NOT_MOVETASK	Argument <code>\TaskRef</code> or <code>\TaskName</code> specify some non-motion task.

No error will be generated if argument `\TaskRef` or `\TaskName` specifies the non-motion task that executes this function `CJointT` (reference to my own non-motion task). The position will then be fetched from the connected motion task.

More examples

More examples of the function `CJointT` are illustrated below.

Example 1

```
! In task T_ROB1
VAR jointtarget joints;
joints := CJointT(\TaskRef:=T_ROB2Id);
```

The current position of the robot and external axes in task `T_ROB2` are stored in `joints` in task `T_ROB1`.

Note that the robot in task `T_ROB2` may be moving when the position is read. To ensure that the robot stands still, a stop point `fine` in the preceding movement instruction in task `T_ROB2` could be programmed and instruction `WaitSyncTask` could be used to synchronize the instructions in task `T_ROB1`.

Example 2

```
! In task T_ROB1
VAR jointtarget joints;
joints := CJointT(\TaskName:="T_ROB2");
```

The same effect as Example 1 above.

Syntax

```
CJointT '('
  ['\TaskRef :=' <variable (VAR) of taskid>]
  |['\TaskName :=' <expression (IN) of string>] ')'

```

A function with a return value of the data type `jointtarget`.

Related information

For information about	See
Definition of joint	jointtarget - Joint position data on page 1679
Reading the current motor angle	ReadMotor - Reads the current motor angles on page 1429

2 Functions

2.42 ClkRead - Reads a clock used for timing

RobotWare Base

2.42 ClkRead - Reads a clock used for timing

Usage

ClkRead is used to read a clock that functions as a stop-watch used for timing.

Basic examples

The following examples illustrate the function ClkRead.

Example 1

```
reg1:=ClkRead(clock1);
```

The clock `clock1` is read and the time in seconds is stored in the variable `reg1`.

Example 2

```
reg1:=ClkRead(clock1 \HighRes);
```

The clock `clock1` is read and the time in seconds is stored with high resolution in the variable `reg1`.

Return value

Data type: num

The time in seconds stored in the clock. Resolution is normally 0.001 seconds. If using `HighRes` switch it is possible to get a resolution of 0.000001 seconds.

Argument

```
ClkRead (Clock \HighRes)
```

Clock

Data type: clock

The name of the clock to read.

[\HighRes]

High Resolution

Data type: switch

Specifies that the time should be read with a higher resolution. If this switch is used it is possible to read the time with resolution 0.000001.

Due to the precision of the data type num, you can only get the micro second resolution as long as the read value is less than 1 second.

Program execution

A clock can be read when it is stopped or running.

Once a clock is read it can be read again, started again, stopped, or reset.

Error handling

The following recoverable errors are generated and can be handled in an error handler. The system variable `ERRNO` will be set to:

Name	Cause of error
ERR_OVERFLOW	The clock runs for 4,294,967 seconds (49 days 17 hours 2 minutes 47 seconds) then it becomes overflowed.

Continues on next page

If using the `HighRes` switch, then the error `ERR_OVERFLOW` can not occur, but the clock will wrap around after approximately 49700 days.

Syntax

```
ClkRead '('  
  [ Clock ':' '=' ] < variable (VAR) of clock >  
  [ '\ ' HighRes ] ')'
```

A function with a return value of the type `num`.

Related information

For information about	See
Clock instructions	<i>Technical reference manual - RAPID Overview</i>
More examples	ClkStart - Starts a clock used for timing on page 148

2 Functions

2.43 CorrRead - Reads the current total offsets

Path Offset

2.43 CorrRead - Reads the current total offsets

Usage

`CorrRead` is used to read the total corrections delivered by all connected correction generators.

`CorrRead` can be used to:

- find out how much the current path differs from the original path.
- take actions to reduce the difference.

Basic examples

The following example illustrates the function `CorrRead`.

See also [More examples on page 1224](#).

Example 1

```
VAR pos offset;  
...  
offset := CorrRead();
```

The current offsets delivered by all connected correction generators are available in the variable `offset`.

Return value

Data type: `pos`

The total absolute offsets delivered from all connected correction generators so far.

More examples

For more examples of the function `CorrRead`, see instruction `CorrCon`.

Syntax

```
CorrRead '(' ' ')
```

A function with a return value of the data type `pos`.

Related information

For information about	See
Connects to a correction generator	CorrCon - Connects to a correction generator on page 174
Disconnects from a correction generator	CorrDiscon - Disconnects from a correction generator on page 179
Writes to a correction generator	CorrWrite - Writes to a correction generator on page 180
Removes all correction generators	CorrClear - Removes all correction generators on page 173
Correction descriptor	corrdescr - Correction generator descriptor on page 1644

2.44 Cos - Calculates the cosine value

Usage

`Cos` (*Cosine*) is used to calculate the cosine value from an angle value on data types `num`.

Basic examples

The following example illustrates the function `Cos`.

Example 1

```
VAR num angle;
VAR num value;
...
...
value := Cos(angle);
value will get the cosine value of angle.
```

Return value

Data type: `num`
The cosine value, range = [-1, 1].

Arguments

`Cos` (*Angle*)

Angle

Data type: `num`
The angle value, expressed in degrees.

Syntax

```
Cos '('
  [Angle ':='] <expression (IN) of num> ')'
```

A function with a return value of the data type `num`.

Related information

For information about	See
Mathematical instructions and functions	<i>Technical reference manual - RAPID Overview</i>

2 Functions

2.45 CosDnum - Calculates the cosine value

RobotWare Base

2.45 CosDnum - Calculates the cosine value

Usage

`CosDnum` (*Cosine dnum*) is used to calculate the cosine value from an angle value on data types `dnum`.

Basic examples

The following example illustrates the function `CosDnum`.

Example 1

```
VAR dnum angle;  
VAR dnum value;  
...  
...  
value := CosDnum(angle);  
value will get the cosine value of angle.
```

Return value

Data type: `dnum`

The cosine value, range = [-1, 1].

Arguments

`CosDnum` (`Angle`)

Angle

Data type: `dnum`

The angle value, expressed in degrees.

Syntax

```
CosDnum '('  
  [Angle ':=' ] <expression (IN) of dnum> ')'
```

A function with a return value of the data type `dnum`.

Related information

For information about	See
Mathematical instructions and functions	<i>Technical reference manual - RAPID Overview</i>

2.46 CPos - Reads the current position (pos) data

Usage

`CPos` (*Current Position*) is used to read the current position of the robot.

This function returns the x, y, and z values of the robot TCP as data of type `pos`. If the complete robot position (`robtarget`) is to be read then use the function `CRobT` instead.

Basic examples

The following example illustrates the function `CPos`.

See also [More examples on page 1228](#).

Example 1

```
VAR pos pos1;

MoveL *, v500, fine \Inpos := inpos50, tool1;
pos1 := CPos(\Tool:=tool1 \WObj:=wobj0);
```

The current position of the robot TCP is stored in variable `pos1`. The tool `tool1` and work object `wobj0` are used for calculating the position.

Note that the robot is standing still before the position is read and calculated. This is achieved by using the stop point `fine` within position accuracy `inpos50` in the preceding movement instruction.

Return value

Data type: `pos`

The current position (`pos`) of the robot with x, y, and z in the outermost coordinate system, taking the specified tool, work object, and active ProgDisp coordinate system into consideration.

Arguments

```
CPos([\Tool] [\WObj])
```

`[\Tool]`

Data type: `tooldata`

The tool used for calculation of the current robot position.

If this argument is omitted then the current active tool is used.

`[\WObj]`

Work Object

Data type: `wobjdata`

The work object (coordinate system) to which the current robot position returned by the function is related.

If this argument is omitted then the current active work object is used.

Continues on next page

2 Functions

2.46 CPos - Reads the current position (pos) data

RobotWare Base

Continued



WARNING

It is advised to always specify the arguments `\Tool` and `\WObj` during programming. The function will then always return the wanted position even if another tool or work object are activated.

Program execution

The coordinates returned represent the TCP position in the ProgDisp coordinate system.

More examples

More examples of the function `CPos` are illustrated below.

```
VAR pos pos2;  
VAR pos pos3;  
VAR pos pos4;  
  
pos2 := CPos(\Tool:=grip3 \WObj:=fixture);  
...  
pos3 := CPos(\Tool:=grip3 \WObj:=fixture);  
pos4 := pos3-pos2;
```

The x, y, and z position of the robot is captured at two places within the program using the `CPos` function. The tool `grip3` and work object `fixture` are used for calculating the position. The x, y, and z distances travelled between these positions are then calculated and stored in variable `pos4`.

Syntax

```
CPos '('  
  ['\ Tool :=' <persistent (PERS) of tooldata>]  
  ['\ WObj :=' <persistent (PERS) of wobjdata>] ')'
```

A function with a return value of the data type `pos`.

Related information

For information about	See
Definition of position	pos - Positions (only X, Y and Z) on page 1715
Definition of tools	tooldata - Tool data on page 1776
Definition of work objects	wobjdata - Work object data on page 1803
ProgDisp coordinate system	PDispOn - Activates program displacement on page 540
Coordinate systems	Technical reference manual - RAPID Overview
Reading the current <code>robtarg</code>	CRobT - Reads the current position (robtarg) data on page 1229

2.47 CRobT - Reads the current position (robtargt) data

Usage

CRobT(*Current Robot Target*) is used to read the current position of a robot and external axes.

This function returns a `robtargt` value with position (x, y, z), orientation (q1 ... q4), robot axes configuration, and external axes position. If only the x, y, and z values of the robot TCP (`pos`) are to be read then use the function `CPos` instead.

Basic examples

The following example illustrates the function CRobT.

See also [More examples on page 1230](#).

Example 1

```
VAR robtargt p1;
MoveL *, v500, fine \Inpos := inpos50, tool1;
p1 := CRobT(\Tool:=tool1 \WObj:=wobj0);
```

The current position of the robot and external axes is stored in `p1`. The tool `tool1` and work object `wobj0` are used for calculating the position.

Note that the robot is standing still before the position is read and calculated. This is achieved by using the stop point `fine` within position accuracy `inpos50` in the preceding movement instruction.

Return value

Data type: `robtargt`

The current position of a robot and external axes in the outermost coordinate system, taking the specified tool, work object, and active `ProgDisp/ExtOffs` coordinate system into consideration.

Arguments

```
CRobT ([\TaskRef][\TaskName] [\Tool] [\WObj])
```

`[\TaskRef]`

Task Reference

Data type: `taskid`

The program task identity from which the `robtargt` should be read.

For all program tasks in the system, predefined variables of the data type `taskid` will be available. The variable identity will be "taskname"+"Id", for example, for the `T_ROB1` task the variable identity will be `T_ROB1Id`.

`[\TaskName]`

Data type: `string`

The program task name from which the `robtargt` should be read.

If none of the arguments `\TaskRef` or `\TaskName` are specified then the current task is used.

Continues on next page

2 Functions

2.47 CRobT - Reads the current position (robtarget) data

RobotWare Base

Continued

[\Tool]

Data type: tooldata

The persistent variable for the tool used to calculate the current robot position.

If this argument is omitted then the current active tool is used.

[\Wobj]

Work Object

Data type: wobjdata

The persistent variable for the work object (coordinate system) to which the current robot position returned by the function is related.

If this argument is omitted then the current active work object is used.



WARNING

It is advised to always specify the arguments \Tool and \Wobj during programming. The function will then always return the wanted position even if another tool or work object are activated.

Program execution

The coordinates returned represent the TCP position in the ProgDisp coordinate system. External axes are represented in the ExtOffs coordinate system.

If one of the arguments \TaskRef or \TaskName are used but arguments Tool and Wobj are not used then the current tool and work object in the specified task will be used.

Error handling

The following recoverable errors are generated and can be handled in an error handler. The system variable ERRNO will be set to:

Name	Cause of error
ERR_TASKNAME	The program task name in argument \TaskName cannot be found in the system.
ERR_NOT_MOVETASK	Argument \TaskRef or \TaskName specify some non-motion task.

No error will be generated if the arguments \TaskRef or \TaskName specify the non-motion task that executes this function CRobT (reference to my own non-motion task). The position will then be fetched from the connected motion task.

More examples

More examples of the function CRobT are illustrated below.

Example 1

```
VAR robtarget p2;  
p2 := ORobT( CRobT(\Tool:=grip3 \Wobj:=fixture) );
```

The current position in the object coordinate system (without any ProgDisp or ExtOffs) of the robot and external axes is stored in p2. The tool grip3 and work object fixture are used for calculating the position.

Continues on next page

Example 2

```
! In task T_ROB1
VAR robtarget p3;
p3 := CRobT(\TaskRef:=T_ROB2Id \Tool:=tool1 \WObj:=wobj0);
```

The current position of the robot and external axes in task T_ROB2 are stored in p3 in task T_ROB1. The tool tool1 and work object wobj0 are used for calculating the position.

Note that the robot in task T_ROB2 may be moving when the position is read and calculated. To make sure the robot stands still, a stop point fine in the preceding movement instruction in task T_ROB2 could be programmed and instruction WaitSyncTask could be used to synchronize the instructions in task T_ROB1.

Example 3

```
! In task T_ROB1
VAR robtarget p4;
p4 := CRobT(\TaskName:="T_ROB2");
```

The current position of the robot and external axes in task T_ROB2 are stored in p4 in task T_ROB1. The current tool and work object in task T_ROB2 are used for calculating the position.

Syntax

```
CRobT '('
  ['\' TaskRef ':=' <variable (VAR) of taskid>]
  [['\' TaskName ':=' <expression (IN) of string>]
  ['\' Tool ':=' <persistent (PERS) of tooldata>]
  ['\' WObj ':=' <persistent (PERS) of wobjdata>] ')'

```

A function with a return value of the data type robtarget.

Related information

For information about	See
Definition of position	robtargt - Position data on page 1734
Definition of tools	tooldata - Tool data on page 1776
Definition of work objects	wobjdata - Work object data on page 1803
Coordinate systems	<i>Technical reference manual - RAPID Overview</i>
ProgDisp coordinate system	PDispOn - Activates program displacement on page 540
ExtOffs coordinate system	EOffsOn - Activates an offset for additional axes on page 191
Reading the current pos (x, y, z only)	CPos - Reads the current position (pos) data on page 1227

2 Functions

2.48 CrossProd - Cross product of two pos vectors RobotWare Base

2.48 CrossProd - Cross product of two pos vectors

Usage

`CrossProd` (*Cross Product*) is used to calculate the cross product (or vector product) of two `pos` vectors.

The cross product of two vectors **A** and **B** is a vector, perpendicular to both argument vectors. The length of the result vector is equal to the products of the length of **A** and **B** and the sine of the angle between them θ_{AB} .

$$|A \times B| = |A||B| \sin \theta_{AB}$$



Note

- The magnitude of the cross product equals the area of a parallelogram with the vectors as sides.
- The cross product of two parallel vectors is zero.
- $A \times B = -B \times A$

Basic examples

The following example illustrates the function `CrossProd` with perpendicular vectors.

For other examples, see [More examples on page 1233](#).

Example 1

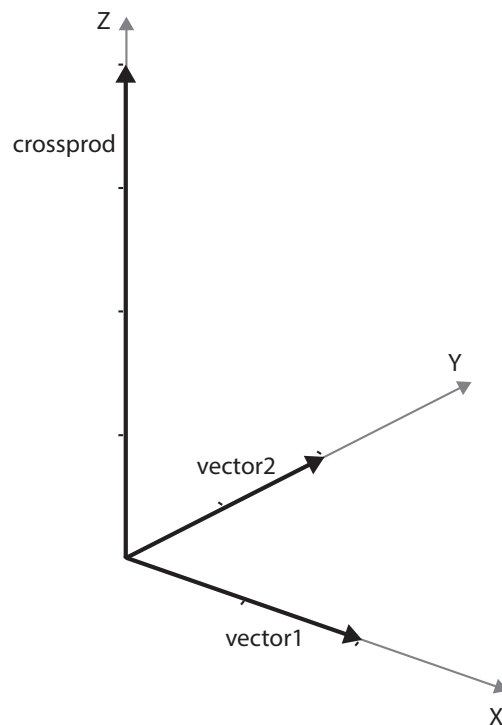

xx1700001570

```
VAR pos crossprod_1;
```

Continues on next page

```

VAR pos vector1;
VAR pos vector2;
...
...
vector1 := [2,0,0];
vector2 := [0,2,0];
crossprod_1 := CrossProd(vector1, vector2);

```

In this example, `vector1` is parallel to the x axis, `vector2` is parallel to the y axis. The cross product is perpendicular to both of them, i.e. parallel to the z axis.

Since the angle between `vector1` and `vector2` is 90° , the magnitude of the cross product is: $2 * 2 * \sin 90^\circ = 4$

Return value

Data type: `pos`

A vector that is the result of the cross product of the two vectors.

Arguments

`CrossProd (Vector1 Vector2)`

`Vector1`

Data type: `pos`

The first vector described by the `pos` data type.

`Vector2`

Data type: `pos`

The second vector described by the `pos` data type.

More examples

More examples of the function `CrossProd` are illustrated below.

Example 2

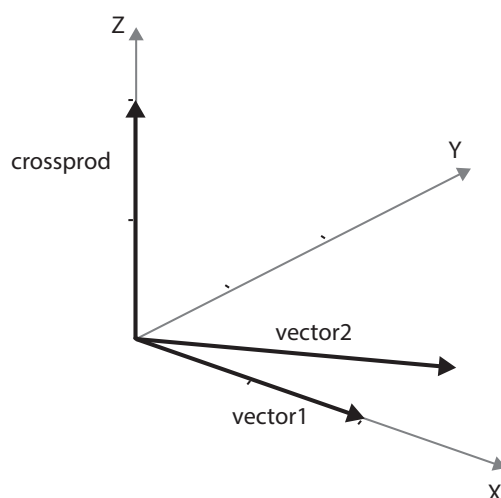

xx1700001571

```

VAR pos crossprod_1;
VAR pos vector1;

```

Continues on next page

2 Functions

2.48 CrossProd - Cross product of two pos vectors

RobotWare Base

Continued

```
VAR pos vector2;  
...  
...  
vector1 := [2,0,0];  
vector2 := [2,1,0];  
crossprod_1 := CrossProd(vector1, vector2);
```

In this example, `vector1` and `vector2` are both in the xy plane. The cross product is perpendicular to both of them, i.e. parallel to the z axis.

The magnitude of `vector1` is 2. The magnitude of `vector2` is $\sqrt{5}$. The angle between `vector1` and `vector2` is 26.565° . The magnitude of the cross product is: $2 * \sqrt{5} * \sin 26.565^\circ = 2$

Syntax

```
CrossProd '('  
  [Vector1 ':='] <expression (IN) of pos>', '  
  [Vector2 ':='] <expression (IN) of pos>  
' )'
```

A function with a return value of the data type `pos`.

Related information

For information about	See
Mathematical instructions and functions	<i>Technical reference manual - RAPID Overview, section RAPID summary - Mathematics</i>

2.49 CSpeedOverride - Reads the current override speed

Usage

`CSpeedOverride` is used to read the speed override set by the operator from the FlexPendant. The return value is displayed as a percentage where 100% corresponds to the programmed speed.

In applications with instruction `SpeedRefresh`, this function can also be used to read current speed override value for this or connected motion program tasks.

Note! Must not be mixed up with the argument `Override` in the RAPID instruction `VelSet`.

Basic examples

The following example illustrates the function `CSpeedOverride`.

Example 1

```
VAR num myspeed;
myspeed := CSpeedOverride();
```

The current override speed will be stored in the variable `myspeed`. For example, if the value is 100 then this is equivalent to 100%.

Return value

Data type: `num`

The override speed value in percent of the programmed speed. This will be a numeric value in the range of 0 - 100.

Arguments

```
CSpeedOverride ( [\CTask] )
```

`[\CTask]`

Data type: `switch`

Get current speed override value for this or connected motion program task. Used together with the instruction `SpeedRefresh`.

If this argument is not used then the function returns current speed override for the whole system (all motion program tasks). Meaning the manual speed override, set from FlexPendant.

Syntax

```
CSpeedOverride '('
  ['\' CTask ] ')'
```

A function with a return value of the data type `num`.

Related information

For information about	See
Changing the Override Speed	<i>Operating manual - IRC5 with FlexPendant, section Programming and Testing Production Running - Quickset menu, Speed</i>

Continues on next page

2 Functions

2.49 CSpeedOverride - Reads the current override speed

RobotWare Base

Continued

For information about	See
Update speed override from RAPID	SpeedRefresh - Update speed override for ongoing movement on page 781

2.50 CTime - Reads the current time as a string

Usage

CTime is used to read the current system time.

This function can be used to present the current time to the operator on the FlexPendant display or to paste the current time into a text file that the program writes to.

Basic examples

The following example illustrates the function CTime.

See also [More examples on page 1237](#).

Example 1

```
VAR string time;
time := CTime();
```

The current time is stored in the variable `time`.

Return value

Data type: `string`

The current time in a string.

The standard time format is "hours:minutes:seconds", for example, "18:20:46".

More examples

More examples of the function CTime are illustrated below.

Example 1

```
VAR string time;
time := CTime();
TPWrite "The current time is: "+time;
Write logfile, time;
```

The current time is written to the FlexPendant display and written into a text file.

Syntax

```
CTime '(' '')
```

A function with a return value of the type `string`.

Related information

For information about	See
Time and date instructions	<i>Technical reference manual - RAPID Overview, section RAPID summary - System & Time</i>
Setting the system clock	<i>Operating manual - IRC5 with FlexPendant, section Changing FlexPendant settings</i>

2 Functions

2.51 CTool - Reads the current tool data

RobotWare Base

2.51 CTool - Reads the current tool data

Usage

`CTool` (*Current Tool*) is used to read the data of the current tool.

Basic examples

The following example illustrates the function `CTool`.

Example 1

```
PERS tooldata temp_tool:= [ TRUE, [ [0, 0, 0], [1, 0, 0, 0] ],  
    [0.001, [0, 0, 0.001], [1, 0, 0, 0], 0, 0, 0] ];  
temp_tool := CTool();
```

The value of the current tool is stored in the variable `temp_tool`.

Return value

Data type: `tooldata`

This function returns a `tooldata` value holding the value of the current tool, that is, the tool last used in a movement instruction.

The value returned represents the TCP position and orientation in the wrist centre coordinate system. See `tooldata`.

Arguments

`CTool` ([\TaskRef][\TaskName])

[\TaskRef]

Task Reference

Data type: `taskid`

The program task identity from which the data of the current tool should be read.

For all program tasks in the system, predefined variables of the data type `taskid` will be available. The variable identity will be "taskname"+"Id", for example, for the `T_ROB1` task the variable identity will be `T_ROB1Id`.

[\TaskName]

Data type: `string`

The program task name from which the data of the current tool should be read.

If none of the arguments `\TaskRef` or `\TaskName` are specified then the current task is used.

Error handling

The following recoverable errors are generated and can be handled in an error handler. The system variable `ERRNO` will be set to:

Name	Cause of error
<code>ERR_TASKNAME</code>	The program task name in argument <code>\TaskName</code> cannot be found in the system.
<code>ERR_NOT_MOVE TASK</code>	Argument <code>\TaskRef</code> or <code>\TaskName</code> specify some non-motion task.

Continues on next page

No error will be generated if the arguments `\TaskRef` or `\TaskName` specify the non-motion task that executes this function `CTool` (reference to my own non-motion task). The tool data will then be fetched from the connected motion task.

Syntax

```
CTool '('  
  ['\' TaskRef ':=' <variable (VAR) of taskid>]  
  | ['\' TaskName ':=' <expression (IN) of string>] ')'
```

A function with a return value of the data type `tooldata`.

Related information

For information about	See
Definition of tools	tooldata - Tool data on page 1776
Coordinate systems	<i>Technical reference manual - RAPID Overview, section Motion and I/O principles - Coordinate Systems</i>

2 Functions

2.52 CWOBJ - Reads the current work object data

RobotWare Base

2.52 CWOBJ - Reads the current work object data

Usage

CWOBJ (*Current Work Object*) is used to read the data of the current work object.

Basic examples

The following example illustrates the function CWOBJ.

Example 1

```
PERS wobjdata temp_wobj:= [FALSE, TRUE, "", [[0,0,0], [1,0,0,0]],  
  [[0,0,0], [1,0,0,0]]];  
temp_wobj := CWOBJ();
```

The value of the current work object is stored in the variable temp_wobj.

Return value

Data type: wobjdata

This function returns a wobjdata value holding the value of the current work object, that is, the work object last used in a movement instruction.

The value returned represents the work object position and orientation in the world coordinate system. See wobjdata.

Arguments

CWOBJ ([\TaskRef][\TaskName])

[\TaskRef]

Task Reference

Data type: taskid

The program task identity from which the data of the current work object should be read.

For all program tasks in the system, predefined variables of the data type taskid will be available. The variable identity will be "taskname"+"Id", for example, for the T_ROB1 task the variable identity will be T_ROB1Id.

[\TaskName]

Data type: string

The program task name from which the data of the current work object should be read.

If none of the arguments \TaskRef or \TaskName are specified then the current task is used.

Error handling

The following recoverable errors are generated and can be handled in an error handler. The system variable ERRNO will be set to:

Name	Cause of error
ERR_TASKNAME	The program task name in argument \TaskName cannot be found in the system.

Continues on next page

Name	Cause of error
ERR_NOT_MOVETASK	Argument <code>\TaskRef</code> or <code>\TaskName</code> specify some non-motion task.

No error will be generated if the arguments `\TaskRef` or `\TaskName` specify the non-motion task that executes this function `CWobj` (reference to my own non-motion task). The work object data will then be fetched from the connected motion task.

Syntax

```
CWobj '('
  ['\ ' TaskRef ':=' <variable (VAR) of taskid>]
  |['\ ' TaskName ':=' <expression (IN) of string>] ')'
```

A function with a return value of the data type `wobjdata`.

Related information

For information about	See
Definition of work objects	wobjdata - Work object data on page 1803
Coordinate systems	<i>Technical reference manual - RAPID Overview, section Motion and I/O Principles - Coordinate Systems</i>

2 Functions

2.53 DecToHex - Convert from decimal to hexadecimal

RobotWare Base

2.53 DecToHex - Convert from decimal to hexadecimal

Usage

DecToHex is used to convert a number specified in a readable string in the base 10 to the base16.

The resulting string is constructed from the character set [0-9,A-F,a-f].

This routine handle numbers from 0 up to 9223372036854775807dec or 7FFFFFFFFFFFFFFF hex.

Basic examples

The following example illustrates the function DecToHex.

Example 1

```
VAR string str;  
  
str := DecToHex("99999999");
```

The variable `str` is given the value "5F5E0FF".

Return value

Data type: `string`

The string converted to a hexadecimal representation of the given number in the inparameter string.

Arguments

```
DecToHex ( Str )
```

Str

String

Data type: `string`

The string to convert.

Syntax

```
DecToHex '('  
  [ Str ':=' ] <expression (IN) of string> ')'
```

A function with a return value of the data type `string`.

Related information

For information about	See
String functions	<i>Technical reference manual - RAPID Overview, section RAPID summary - String functions</i>
Definition of string	string - Strings on page 1761
String values	<i>Technical reference manual - RAPID Overview, section Basic characteristics - Basic elements</i>

2.54 DefAccFrame - Define an accurate frame

Usage

DefAccFrame (*Define Accurate Frame*) is used to define a frame from three to ten original positions and the same number of displaced positions.

Description

A frame can be defined when a set of targets are known at two different locations. Thus, *the same physical positions* are used but expressed differently.

Consider it in two different approaches:

- 1 The same physical positions are expressed in relation to different coordinate systems. For example, a number of positions are retrieved from a CAD drawing, thus the positions are expressed in a CAD local coordinate system. The same positions are then expressed in robot world coordinate system. From these two sets of positions the frame between CAD coordinate system and robot world coordinate system is calculated.
- 2 A number of positions are related to an object in an original position. After a displacement of the object, the positions are determined again (often searched for). From these two sets of positions (old positions, new positions) the displacement frame is calculated.

Three targets are enough to define a frame, but to improve accuracy several points should be used.

Basic examples

The following example illustrates the function DefAccFrame.

Example 1

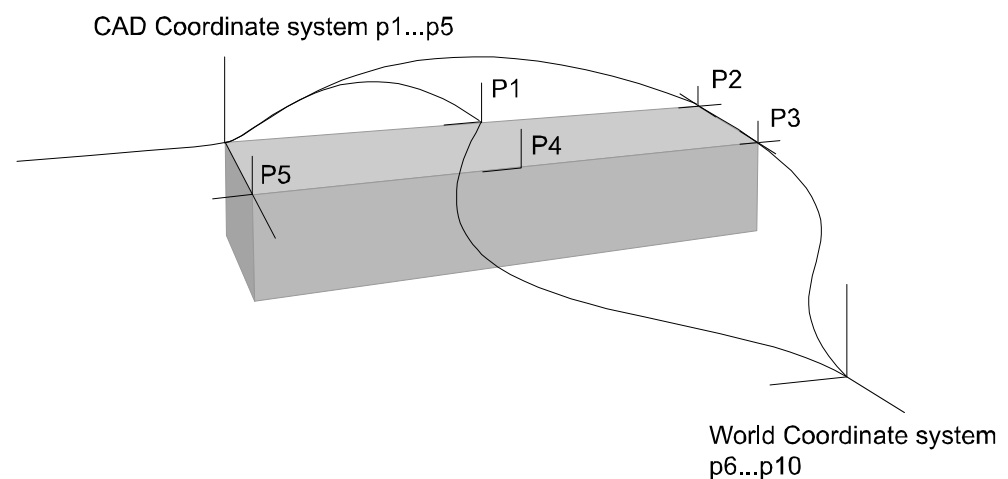

xx0500002179

```
CONST robtarg p1 := [...];
CONST robtarg p2 := [...];
CONST robtarg p3 := [...];
CONST robtarg p4 := [...];
CONST robtarg p5 := [...];
```

Continues on next page

2 Functions

2.54 DefAccFrame - Define an accurate frame

RobotWare Base

Continued

```
VAR robtarget p6 := [...];
VAR robtarget p7 := [...];
VAR robtarget p8 := [...];
VAR robtarget p9 := [...];
VAR robtarget p10 := [...];
VAR robtarget pWCS{5};
VAR robtarget pCAD{5};

VAR pose frame1;
VAR num max_err;
VAR num mean_err;

! Add positions to robtarget arrays
pCAD{1}:=p1;
...
pCAD{5}:=p5;

pWCS{1}:=p6;
...
pWCS{5}:=p10;
frame1 := DefAccFrame (pCAD, pWCS, 5, max_err, mean_err);
```

Five positions p1- p5 related to an object have been stored. The five positions are also stored in relation to world coordinate system as p6-p10. From these 10 positions the frame, frame1, between the object and the world coordinate system is calculated. The frame will be the CAD frame expressed in the world coordinate system. If the input order of the targetlists is exchanged, that is, DefAccFrame (pWCS, pCAD...) then the world frame will be expressed in the CAD coordinate system.

Return value

Data type: pose

The calculated TargetListOne frame expressed in the TargetListTwo coordinate system.

Arguments

```
DefAccFrame (TargetListOne TargetListTwo TargetsInList
             MaxErrMeanErr)
```

TargetListOne

Data type: robtarget

Array of robtargets holding the positions defined in coordinate system one. Minimum number of robtargets is 3, maximum is 10.

TargetListTwo

Data type: robtarget

Array of robtargets holding the positions defined in coordinate system two. Minimum number of robtargets is 3, maximum is 10.

Continues on next page

TargetsInList

Data type: num

Number of robtargets in an array.

MaxErr

Data type: num

The estimated maximum error in mm.

MeanErr

Data type: num

The estimated mean error in mm.

Error handling

The following recoverable errors are generated and can be handled in an error handler. The system variable `ERRNO` will be set to:

Name	Cause of error
ERR_FRAME	The positions don't have the required relation or are not specified with enough accuracy.

Syntax

```
DefAccFrame '('
  [TargetListOne ':=' ] <array {*} (IN) of robtarget> ','
  [TargetListTwo ':=' ] <array {*} (IN) of robtarget> ','
  [TargetsInList ':=' ] <expression (IN) of num> ','
  [MaxErr ':=' ] <variable (VAR) of num> ','
  [MeanErr ':=' ] <variable (VAR) of num> ')'
```

A function with a return value of the data type `pose`.

Related information

For information about	See
Calculating a frame from three positions	DefFrame - Define a frame on page 1249
Calculate a frame from 6 positions	DefDFrame - Define a displacement frame on page 1246

2 Functions

2.55 DefDFrame - Define a displacement frame

RobotWare Base

2.55 DefDFrame - Define a displacement frame

Usage

DefDFrame(*Define Displacement Frame*) is used to calculate a displacement frame from three original positions and three displaced positions.

Basic examples

The following example illustrates the function DefDFrame.

Example 1

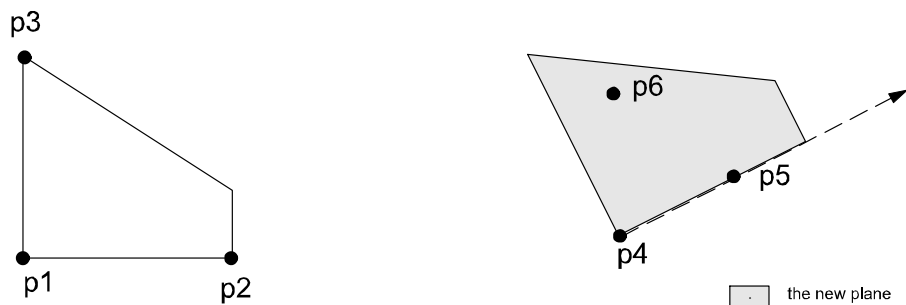

xx0500002177

```
CONST robtarget p1 := [...];
CONST robtarget p2 := [...];
CONST robtarget p3 := [...];
VAR robtarget p4;
VAR robtarget p5;
VAR robtarget p6;
VAR pose frame1;
...
!Search for the new positions
SearchL sen1, p4, *, v50, tool1;
...
SearchL sen1, p5, *, v50, tool1;
...
SearchL sen1, p6, *, v50, tool1;
frame1 := DefDframe (p1, p2, p3, p4, p5, p6);
...
!Activation of the displacement defined by frame1
PDispSet frame1;
```

Three positions p_1 - p_3 related to an object in an original position have been stored. After a displacement of the object, three new positions are searched for and stored as p_4 - p_6 . The displacement frame is calculated from these six positions. Then the calculated frame is used to displace all the stored positions in the program.

Return value

Data type: pose

The displacement frame.

Continues on next page

Arguments

```
DefDFrame (OldP1 OldP2 OldP3 NewP1 NewP2 NewP3)
```

OldP1

Data type: robtarget

The first original position.

OldP2

Data type: robtarget

The second original position.

OldP3

Data type: robtarget

The third original position.

NewP1

Data type: robtarget

The first displaced position. The difference between OldP1 and NewP1 will define the translation part of the frame and must be measured and determined with great accuracy.

NewP2

Data type: robtarget

The second displaced position. The line NewP1 ... NewP2 will define the rotation of the old line OldP1 ... OldP2.

NewP3

Data type: robtarget

The third displaced position. This position will define the rotation of the plane, for example, it should be placed on the new plane of NewP1, NewP2, and NewP3.

Error handling

The following recoverable errors are generated and can be handled in an error handler. The system variable ERRNO will be set to:

Name	Cause of error
ERR_FRAME	It is not possible to calculate the frame because of bad accuracy in the positions.

Syntax

```
DefDFrame '('
  [OldP1 ':=' ] <expression (IN) of robtarget> ','
  [OldP2 ':=' ] <expression (IN) of robtarget> ','
  [OldP3 ':=' ] <expression (IN) of robtarget> ','
  [NewP1 ':=' ] <expression (IN) of robtarget> ','
  [NewP2 ':=' ] <expression (IN) of robtarget> ','
  [NewP3 ':=' ] <expression (IN) of robtarget> ')'
```

A function with a return value of the data type pose.

Continues on next page

2 Functions

2.55 DefDFrame - Define a displacement frame

RobotWare Base

Continued

Related information

For information about	See
Activation of displacement frame	<i>PDispSet - Activates program displacement using known frame on page 545</i>
Manual definition of displacement frame	<i>Operating manual - IRC5 with FlexPendant, section Calibrating</i>

2.56 DefFrame - Define a frame

Usage

DefFrame (*Define Frame*) is used to calculate a frame, from three positions defining the frame.

Basic examples

The following example illustrates the function DefFrame.

Example 1

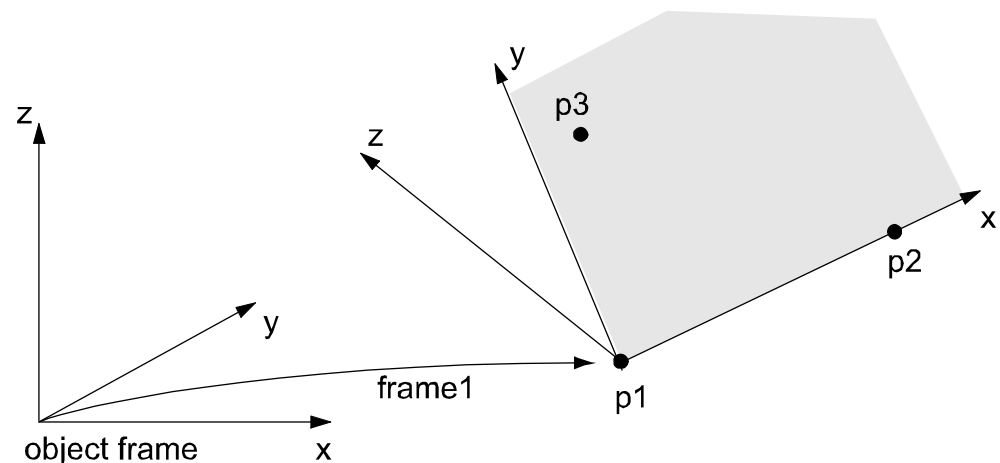

xx0500002181

Three positions, p1- p3 related to the object coordinate system are used to define the new coordinate system, frame1. The first position, p1, is defining the origin of the new coordinate system. The second position, p2, is defining the direction of the x-axis. The third position, p3, is defining the location of the xy-plane. The defined frame1 may be used as a displacement frame, as shown in the example below:

```

CONST robtarget p1 := [...];
CONST robtarget p2 := [...];
CONST robtarget p3 := [...];
VAR pose frame1;
...
...
frame1 := DefFrame (p1, p2, p3);
...
...
!Activation of the displacement defined by frame1
PDispSet frame1;

```

Return value

Data type: pose

The calculated frame.

The calculation is related to the active object coordinate system.

Continues on next page

2 Functions

2.56 DefFrame - Define a frame

RobotWare Base

Continued

Arguments

```
DefFrame (NewP1 NewP2 NewP3 [\Origin])
```

NewP1

Data type: robtarget

The first position, which will define the origin of the new coordinate system.

NewP2

Data type: robtarget

The second position, which will define the direction of the x-axis of the new coordinate frame.

NewP3

Data type: robtarget

The third position, which will define the xy-plane of the new coordinate system.

The position of point 3 will be on the positive y side, see the figure above.

[\Origin]

Data type: num

Optional argument, which will define how the origin of the new coordinate system will be placed. `Origin = 1` means that the origin is placed in `NewP1`, that is, the same as if this argument is omitted. `Origin = 2` means that the origin is placed in `NewP2`. See the figure below.

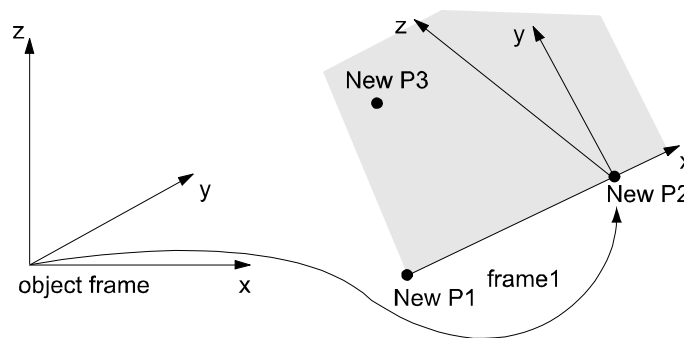

xx0500002178

`Origin = 3` means that the origin is placed on the line going through `NewP1` and `NewP2` and so that `NewP3` will be placed on the y axis. See the figure below.

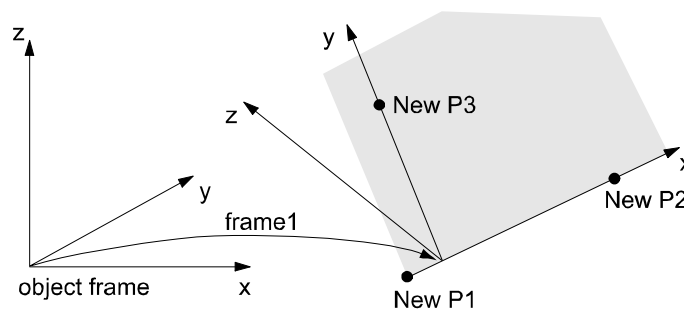

xx0500002180

Other values, or if `Origin` is omitted, will place the origin in `NewP1`.

Continues on next page

Error handling

The following recoverable errors are generated and can be handled in an error handler. The system variable `ERRNO` will be set to:

Name	Cause of error
ERR_FRAME	The frame cannot be calculated because of the below limitations.

Limitations

The three positions `p1` - `p3`, defining the frame, must define a well shaped triangle. The most well shaped triangle is the one with all sides of equal length.

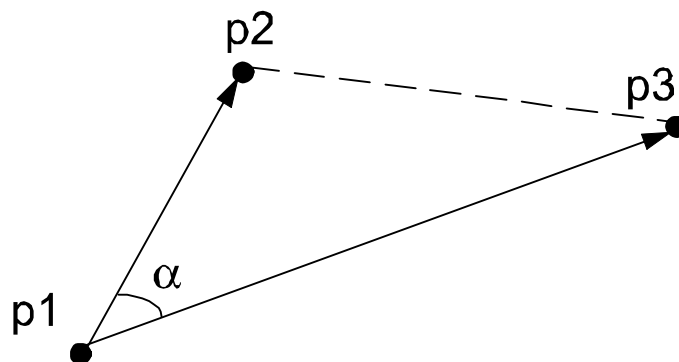

xx0500002182

The triangle is not considered to be well shaped if the angle α is too small. The angle α is too small if:

$$|\cos \alpha| < 1 - 10^{-4}$$

The triangle `p1`, `p2`, `p3` must not be too small, that is, the positions cannot be too close. The distances between the positions `p1` - `p2` and `p1` - `p3` must not be less than 0.1 mm.

Syntax

```
DefFrame '('
  [NewP1 ':='] <expression (IN) of robtarget> ','
  [NewP2 ':='] <expression (IN) of robtarget> ','
  [NewP3 ':='] <expression (IN) of robtarget>
  ['\' Origin ':='] <expression (IN) of num > ')''
```

A function with a return value of the data type `pose`.

Related information

For information about	See
Mathematical instructions and functions	<i>Technical reference manual - RAPID Overview, section RAPID summary - Mathematics</i>
Activation of displacement frame	PDispSet - Activates program displacement using known frame on page 545

2 Functions

2.57 Dim - Obtains the size of an array

RobotWare Base

2.57 Dim - Obtains the size of an array

Usage

`Dim` (*Dimension*) is used to obtain the number of elements in an array.

Basic examples

The following example illustrates the function `Dim`.

See also [More examples on page 1252](#).

Example 1

```
PROC arrmul(VAR num array{*}, num factor)
  FOR index FROM 1 TO Dim(array, 1) DO
    array{index} := array{index} * factor;
  ENDFOR
ENDPROC
```

All elements of a num array are multiplied by a factor. This procedure can take any one-dimensional array of data type `num` as an input.

Return value

Data type: `num`

The number of array elements of the specified dimension.

Arguments

`Dim` (`ArrPar` `DimNo`)

`ArrPar`

Array Parameter

Data type: `anytype`

The name of the array.

`DimNo`

Dimension Number

Data type: `num`

The desired array dimension:

1 = first dimension

2 = second dimension

3 = third dimension

More examples

More examples of how to use the function `Dim` are illustrated below.

Example 1

```
PROC add_matrix(VAR num array1{*,*,*}, num array2{*,*,*})

  IF Dim(array1,1) <> Dim(array2,1) OR Dim(array1,2) <>
    Dim(array2,2) OR Dim(array1,3) <> Dim(array2,3) THEN
    TPWrite "The size of the matrices are not the same";
    Stop;
```

Continues on next page

```

ELSE
  FOR i1 FROM 1 TO Dim(array1, 1) DO
    FOR i2 FROM 1 TO Dim(array1, 2) DO
      FOR i3 FROM 1 TO Dim(array1, 3) DO
        array1{i1,i2,i3} := array1{i1,i2,i3} + array2{i1,i2,i3};
      ENDFOR
    ENDFOR
  ENDFOR
ENDIF
RETURN;

ENDPROC

```

Two matrices are added. If the size of the matrices differs then the program stops and an error message appears.

This procedure can take any three-dimensional array of data type `num` as an input.

Syntax

```

Dim '('
  [ArrPar ':=' ] <reference (REF) of anytype> ','
  [DimNo ':=' ] <expression (IN) of num> ')'

```

A REF parameter requires that the corresponding argument be either a constant, a variable, or an entire persistent. The argument could also be an IN parameter, a VAR parameter, or an entire PERS parameter.

A function with a return value of the data type `num`.

Related information

For information about	See
Array parameters	<i>Technical reference manual - RAPID Overview, section Basic characteristics - Routines</i>
Array declaration	<i>Technical reference manual - RAPID Overview, section Basic characteristics - Data</i>

2 Functions

2.58 DInput - Reads the value of a digital input signal

RobotWare Base

2.58 DInput - Reads the value of a digital input signal

Usage

DInput is used to read the current value of a digital input signal.



Note

Note that the function DInput is a legacy function that no longer has to be used. See the examples for an alternative and recommended way of programming.

Basic examples

The following example illustrates the function DInput.

See also [More examples on page 1254](#).

Example 1

```
IF DInput(di2) = 1 THEN ...  
...  
IF di2 = 1 THEN ...
```

If the current value of the signal di2 is equal to 1, then ...

Return value

Data type: num

The current value of the signal (0 or 1).

Arguments

DInput (Signal)

Signal

Data type: signaldi

The name of the digital input to be read.

Program execution

The value read depends on the configuration of the signal. If the signal is inverted in the system parameters, the value returned by this function is the opposite of the value of the physical channel.

More examples

More examples of how to use the function DInput are illustrated below.

Example 1

```
weld_flag := DInput(weld);  
...  
weld_flag := weld;
```

Continues on next page

The variable `weld_flag` is set to the same value as the current value of the signal `weld`.

**Note**

Note that, in this case, the `weld_flag` reflects the current value of the signal. Thus, if `weld_flag` is used later in the program, you cannot be certain that it will reflect the current value of the signal.

Syntax

```
DInput '('
  [Signal ':='] <variable (VAR) of signaladi>')'
```

A function with a return value of the data type `dionum`.

Related information

For information about	See
Input/Output instructions	<i>Technical reference manual - RAPID Overview, section RAPID Summary - Input and Output Signals</i>
Input/Output functionality in general	<i>Technical reference manual - RAPID Overview, section Motion and I/O Principles - I/O principles</i>
Configuration of I/O	<i>Technical reference manual - System parameters</i>

2 Functions

2.59 Distance - Distance between two points

RobotWare Base

2.59 Distance - Distance between two points

Usage

`Distance` is used to calculate the distance between two points in the space.

Basic examples

The following example illustrates the function `Distance`.

Example 1

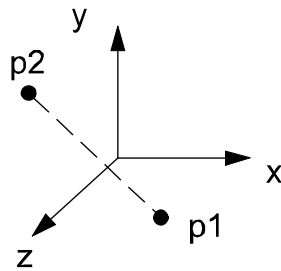

xx0500002321

```
VAR num dist;  
CONST pos p1 := [4,0,4];  
CONST pos p2 := [-4,4,4];  
...  
dist := Distance(p1, p2);
```

The distance in space between the points `p1` and `p2` is calculated and stored in the variable `dist`.

Return value

Data type: `num`

The distance (always positive) in mm between the points.

Arguments

`Distance (Point1 Point2)`

`Point1`

Data type: `pos`

The first point described by the `pos` data type.

`Point2`

Data type: `pos`

The second point described by the `pos` data type.

Continues on next page

Program execution

Calculation of the distance between the two points:

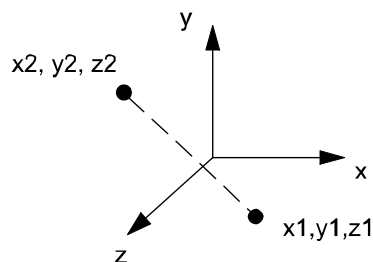

xx0500002322

$$\text{distance} = \sqrt{\left((x_1 - x_2)^2 + (y_1 - y_2)^2 + (z_1 - z_2)^2 \right)}$$

xx0500002323

Syntax

```
Distance '('
  [Point1 ':=' ] <expression (IN) of pos> ','
  [Point2 ':=' ] <expression (IN) of pos> ')'
```

A function with a return value of the data type `num`.

Related information

For information about	See
Mathematical instructions and functions	<i>Technical reference manual - RAPID Overview</i> , section <i>RAPID Summary - Mathematics</i>
Definition of pos	pos - Positions (only X, Y and Z) on page 1715

2 Functions

2.60 DIV - Evaluates an integer division

RobotWare Base

2.60 DIV - Evaluates an integer division

Usage

DIV is a conditional expression used to evaluate a division of integers.

Basic examples

The following examples illustrate the function DIV.

Example 1

```
reg1 := 14 DIV 4;
```

The return value is 3 because 14 can be divided by 4 for 3 times.

Example 2

```
VAR dnum mydnum1 := 10;  
VAR dnum mydnum2 := 5;  
VAR dnum mydnum3;  
...  
mydnum3 := mydnum1 DIV mydnum2;
```

The return value is 2 because 10 can be divided by 5 for 2 times.

Return value

Data type: num, dnum

Returns the integer, whole number, from a division of integers.

Syntax

```
<expression of num> DIV <expression of num>
```

A function with a return value of data type num.

```
<expression of dnum> DIV <expression of dnum>
```

A function with a return value of data type dnum.

Related information

For information about	See
num - Numeric values	num - Numeric values on page 1698
dnum - Double numeric values	dnum - Double numeric values on page 1649
MOD	MOD - Evaluates an integer modulo on page 1367
Expressions	Technical reference manual - RAPID Overview

2.61 DnumToNum - Converts dnum to num

Usage

DnumToNum converts a dnum to a num if possible, otherwise it generates a recoverable error.

Basic examples

The following example illustrates the function DnumToNum.

Example 1

```
VAR num mynum:=0;
VAR dnum mydnum:=8388607;
VAR dnum testFloat:=8388609;
VAR dnum anotherdnum:=4294967295;
! Works OK
mynum:=DnumToNum(mydnum);
! Accept floating point value
mynum:=DnumToNum(testFloat);
! Cause error recovery error
mynum:=DnumToNum(anotherdnum \Integer);
```

The dnum value 8388607 is returned by the function as the num value 8388607.

The dnum value 8388609 is returned by the function as the num value 8.38861E+06.

The dnum value 4294967295 generates the recoverable error ERR_ARGVALERR.

Return value

Data type: num

The input dnum value can be in the range -8388607 to 8388608 and return the same value as a num. If the `\Integer` switch is not used, the input dnum value can be in the range -3.40282347E+38 to 3.40282347E+38 and the return value might become a floating point value.

Arguments

DnumToNum (Value [`\Integer`])

Value

Data type: dnum

The numeric value to be converted.

[`\Integer`]

Data type: switch

Only integer values.

If the switch `\Integer` is not used, a down cast is made even if the value becomes a floating point value. If it is used, a check is made whether the value is an integer between -8388607 to 8388608. If the value is not in the interval, a recoverable error is generated.

Continues on next page

2 Functions

2.61 DnumToNum - Converts dnum to num

RobotWare Base

Continued

Error handling

The following recoverable errors are generated and can be handled in an error handler. The system variable `ERRNO` will be set to:

Name	Cause of error
<code>ERR_ARGVALERR</code>	Value is above 8388608 or below -8388607 or not an integer (if optional argument <code>Integer</code> is used)
<code>ERR_NUM_LIMIT</code>	Value is above 3.40282347E+38 or below -3.40282347E+38
<code>ERR_INT_NOTVAL</code>	Value is not an integer

Syntax

```
DnumToNum '('  
  [ Value ':= ' ] < expression (IN) of dnum >  
  ['\' Integer ')'
```

A function with a return value of the data type `num`.

Related information

For information about	See
Dnum data type	dnum - Double numeric values on page 1649.
Num data type	num - Numeric values on page 1698.

2.62 DnumToStr - Converts numeric value to string

Usage

DnumToStr (*Numeric To String*) is used to convert a numeric value to a string.

Basic examples

The following examples illustrate the function DnumToStr.

Example 1

```
VAR string str;  
str := DnumToStr(0.3852138754655357,3);
```

The variable `str` is given the value "0.385".

Example 2

```
VAR dnum val;  
val:= 0.3852138754655357;  
str := DnumToStr(val, 2\Exp);
```

The variable `str` is given the value "3.85E-01".

Example 3

```
VAR dnum val;  
val := 0.3852138754655357;  
str := DnumToStr(val, 15);
```

The variable `str` is given the value "0.385213875465536".

Example 4

```
VAR dnum val;  
val:=4294967295.385215;  
str := DnumToStr(val, 4);
```

The variable `str` is given the value "4294967295.3852".

Example 5

```
reg1 := 0.38521;  
str := DnumToStr(reg1, 2\Compact);
```

The variable `str` is given the value "0.39".

Return value

Data type: `str`

The numeric value converted to a string with the specified number of decimals, with exponent if so requested. The numeric value is rounded if necessary. The decimal point is suppressed if no decimals are included.

Arguments

```
DnumToStr (Val Dec [\Exp] | [\Compact])
```

Val

Value

Data type: `dnum`

The numeric value to be converted.

Continues on next page

2 Functions

2.62 DnumToStr - Converts numeric value to string

RobotWare Base

Continued

Dec

Decimals

Data type: num

Number of decimals. The number of decimals must not be negative or greater than the available precision for numeric values.

Max number of decimals that can be used is 15.

[\Exp]

Exponent

Data type: switch

To use exponent in return value.

[\Compact]

Compact

Data type: switch

To be used to get a short format in the return value.

Syntax

```
DnumToStr '('  
  [ Val ':=' ] <expression (IN) of dnum>  
  [ Dec ':=' ] <expression (IN) of num>  
  ['\ Exp ] | ['\ Compact ]')'
```

A function with a return value of the data type string.

Related information

For information about	See
String functions	<i>Technical reference manual - RAPID Overview, section RAPID summary - String functions</i>
Definition of string	string - Strings on page 1761
String values	<i>Technical reference manual - RAPID Overview, section Basic characteristics - Basic elements</i>
Convert a num numeric value to a string	NumToStr - Converts numeric value to string on page 1379

2.63 DotProd - Dot product of two pos vectors

Usage

`DotProd` (*Dot Product*) is used to calculate the dot (or scalar) product of two pos vectors. The typical use is to calculate the projection of one vector upon the other or to calculate the angle between the two vectors.

Basic examples

The following example illustrates the function `DotProd`.

Example 1

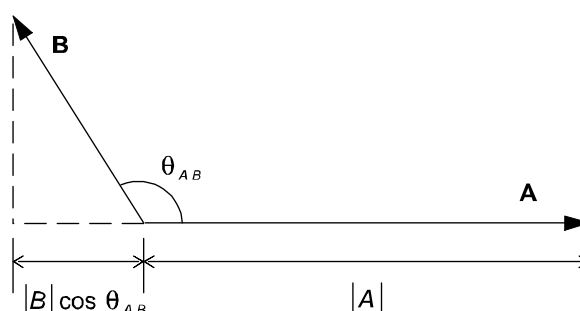

xx0500002449

The dot or scalar product of two vectors **A** and **B** is a scalar, which equals the products of the magnitudes of **A** and **B** and the cosine of the angle between them.

$$A \cdot B = |A||B| \cos \theta_{AB}$$

The dot product:

- is less than or equal to the product of their magnitudes.
- can be either a positive or a negative quantity, depending on whether the angle between them is smaller or larger than 90 degrees.
- is equal to the product of the magnitude of one vector and the projection of the other vector upon the first one.
- is zero when the vectors are perpendicular to each other.

The vectors are described by the data type `pos` and the dot product by the data type `num`:

```
VAR num dotprod;
VAR pos vector1;
VAR pos vector2;
...
...
vector1 := [1,1,1];
vector2 := [1,2,3];
dotprod := DotProd(vector1, vector2);
```

Return value

Data type: `num`

Continues on next page

2 Functions

2.63 DotProd - Dot product of two pos vectors

RobotWare Base

Continued

The value of the dot product of the two vectors.

Arguments

```
DotProd (Vector1 Vector2)
```

Vector1

Data type: pos

The first vector described by the pos data type.

Vector2

Data type: pos

The second vector described by the pos data type.

Syntax

```
DotProd '('  
  [Vector1 ':=' ] <expression (IN) of pos> ','  
  [Vector2 ':=' ] <expression (IN) of pos>  
  ')'
```

A function with a return value of the data type num.

Related information

For information about	See
Mathematical instructions and functions	<i>Technical reference manual - RAPID Overview, section RAPID summary - Mathematics</i>

2.64 DOutput - Reads the value of a digital output signal

Usage

DOutput is used to read the current value of a digital output signal.



Note

Note that the function DOutput is a legacy function that no longer has to be used. See the examples for an alternative and recommended way of programming.

Basic examples

The following example illustrates the function DOutput.

See also [More examples on page 1266](#).

Example 1

```
IF DOutput(do2) = 1 THEN ...
...
IF do2 = 1 THEN ...
```

If the current value of the signal do2 is equal to 1, then ...

Return value

Data type: dionum

The current value of the signal (0 or 1).

Arguments

DOutput (Signal)

Signal

Data type: signaldo

The name of the signal to be read.

Program execution

The value read depends on the configuration of the signal. If the signal is inverted in the system parameters then the value returned by this function is the opposite of the true value of the physical channel.

Error handling

The following recoverable errors can be generated. The errors can be handled in an ERROR handler. The system variable ERRNO will be set to:

Name	Cause of error
ERR_NO_ALIASIO_DEF	The signal variable is a variable declared in RAPID. It has not been connected to an I/O signal defined in the I/O configuration with instruction AliasIO.
ERR_NORUNUNIT	If there is no contact with the I/O device.
ERR_SIG_NOT_VALID	The I/O signal cannot be accessed. The reasons can be that the I/O device is not running or an error in the configuration (only valid for ICI field bus).

Continues on next page

2 Functions

2.64 DOutput - Reads the value of a digital output signal

RobotWare Base

Continued

More examples

More examples of the function `DOutput` are illustrated below.

Example 1

```
IF DOutput(auto_on) <> active THEN ...  
...  
IF auto_on <> active THEN ...
```

If the current value of the system signal `auto_on` is not active then ..., that is, if the robot is in the manual operating mode, then ...



Note

The signal must first be defined as a system output in the system parameters.

Syntax

```
DOutput '('  
  [ Signal ':= ' ] < variable (VAR) of signaldo > ')'
```

A function with a return value of the data type `dionum`.

Related information

For information about	See
Set a digital output signal	SetDO - Changes the value of a digital output signal on page 704
Input/Output instructions	<i>Technical reference manual - RAPID Overview, section RAPID Summary - Input and Output Signals</i>
Input/Output functionality in general	<i>Technical reference manual - RAPID Overview, section Motion and I/O Principles - I/O Principles</i>
Configuration of I/O	<i>Technical reference manual - System parameters</i>

2.65 EulerZYX - Gets euler angles from orient

Usage

EulerZYX (*Euler ZYX rotations*) is used to get an Euler angle component from an orient type variable.

Basic examples

The following example illustrates the function EulerZYX.

Example 1

```
VAR num anglex;
VAR num angley;
VAR num anglez;
VAR pose object;
...
...
anglex := EulerZYX(\X, object.rot);
angley := EulerZYX(\Y, object.rot);
anglez := EulerZYX(\Z, object.rot);
```

Return value

Data type: num

The corresponding Euler angle, expressed in degrees, range from [-180, 180].

Arguments

EulerZYX ([\X] | [\Y] | [\Z] Rotation)

[\X]

Data type: switch

Gets the rotation around the X axis.

[\Y]

Data type: switch

Gets the rotation around the Y axis.

[\Z]

Data type: switch

Gets the rotation around the Z axis.

Note!

The arguments \X, \Y, and \Z are mutually exclusive. If none of these are specified then a run-time error is generated.

Rotation

Data type: orient

The rotation in its quaternion representation.

Continues on next page

2 Functions

2.65 EulerZYX - Gets euler angles from orient

RobotWare Base

Continued

Syntax

```
EulerZYX '('  
  ['\ ' X ','] | ['\ ' Y ','] | ['\ ' Z ',']  
  [Rotation ':=' ] <expression (IN) of orient> ')'
```

A function with a return value of the data type `num`.

Related information

For information about	See
Mathematical instructions and functions	<i>Technical reference manual - RAPID Overview, section RAPID summary - Mathematics</i>

2.66 EventType - Get current event type inside any event routine

Usage

`EventType` can be used in any event routine and then returns the current executed event type.

If `EventType` is called from any program task routine then `EventType` always returns 0 meaning `EVENT_NONE`.

Basic examples

The following example illustrates the function `EventType`.

Example 1

```
TEST EventType()
CASE EVENT_NONE:
    ! Not executing any event
CASE EVENT_POWERON:
    ! Executing POWER ON event
CASE EVENT_START:
    ! Executing START event
CASE EVENT_STOP:
    ! Executing STOP event
CASE EVENT_QSTOP:
    ! Executing QSTOP event
CASE EVENT_RESTART:
    ! Executing RESTART event
CASE EVENT_RESET:
    ! Executing RESET event
CASE EVENT_STEP:
    ! Executing STEP event
ENDTEST
```

Use of function `EventType` inside any event routine to find out which system event, if any, is executing now.

Return value

Data type: `event_type`

The current executed event type 1 ... 7, or 0 if no event routine is executed.

Predefined data

The following predefined symbolic constants of type `event_type` can be used to check the return value:

```
CONST event_type EVENT_NONE := 0;
CONST event_type EVENT_POWERON := 1;
CONST event_type EVENT_START := 2;
CONST event_type EVENT_STOP := 3;
CONST event_type EVENT_QSTOP := 4;
CONST event_type EVENT_RESTART := 5;
CONST event_type EVENT_RESET := 6;
CONST event_type EVENT_STEP := 7;
```

Continues on next page

2 Functions

2.66 EventType - Get current event type inside any event routine

RobotWare Base

Continued

Syntax

```
EventType '(' ' ')
```

A function with a return value of the data type `event_type`.

Related information

For information about	See
Event routines in general	<i>Technical reference manual - System parameters</i> , section <i>Controller - Event Routine</i>
Data type <code>event_type</code> , predefined constants	event_type - Event routine type on page 1663

2.67 ExecHandler - Get type of execution handler

Usage

`ExecHandler` can be used to find out if the actual RAPID code is executed in any RAPID program routine handler.

Basic examples

The following example illustrates the function `ExecHandler`.

Example 1

```

TEST ExecHandler()
CASE HANDLER_NONE:
  ! Not executing in any routine handler
CASE HANDLER_BWD:
  ! Executing in routine BACKWARD handler
CASE HANDLER_ERR:
  ! Executing in routine ERROR handler
CASE HANDLER_UNDO:
  ! Executing in routine UNDO handler
ENDTEST

```

Use of function `ExecHandler` to find out if the code is executing in some type of routine handler or not.

`HANDLER_ERR` will be returned even if the call is executed in a submethod to the error handler.

Return value

Data type: `handler_type`

The current executed handler type 1 ... 3, or 0 if not executing in any routine handler.

Predefined data

The following predefined symbolic constants of type `handler_type` can be used to check the return value:

```

CONST handler_type HANDLER_NONE := 0;
CONST handler_type HANDLER_BWD := 1;
CONST handler_type HANDLER_ERR := 2;
CONST handler_type HANDLER_UNDO := 3;

```

Syntax

```
ExecHandler '(' '')
```

A function with a return value of the data type `handler_type`.

Related information

For information about	See
Type of execution handler	handler_type - Type of execution handler on page 1670

2 Functions

2.68 ExecLevel - Get execution level

RobotWare Base

2.68 ExecLevel - Get execution level

Usage

`ExecLevel` can be used to find out current execution level for the RAPID code that currently is executed.

Basic examples

The following example illustrates the function `ExecLevel`.

Example 1

```
TEST ExecLevel()  
CASE LEVEL_NORMAL:  
  ! Execute on base level  
CASE LEVEL_TRAP:  
  ! Execute in TRAP routine  
CASE LEVEL_SERVICE:  
  ! Execute in service, event or system input interrupt routine  
ENDTEST
```

Use of function `ExecLevel` to find out the current execution level.

Return value

Data type: `exec_level`

The current execution level 0... 2.

Predefined data

The following predefined symbolic constants of type `exec_level` can be used to check the return value:

```
CONST exec_level LEVEL_NORMAL := 0;  
CONST exec_level LEVEL_TRAP := 1;  
CONST exec_level LEVEL_SERVICE := 2;
```

Syntax

```
ExecLevel '(' ')'
```

A function with a return value of the data type `exec_level`.

Related information

For information about	See
Data type for execution level	exec_level - Execution level on page 1664

2.69 Exp - Calculates the exponential value

Usage

`Exp` (*Exponential*) is used to calculate the exponential value, e^x .

Basic examples

The following example illustrates the function `Exp`.

Example 1

```
VAR num x;  
VAR num value;  
...  
value:= Exp( x);
```

value will get the exponential value of `x`.

Return value

Data type: num
The exponential value e^x .

Arguments

`Exp` (Exponent)

Exponent

Data type: num
The exponent argument value.

Syntax

```
Exp '('  
  [Exponent ':=' ] <expression (IN) of num> ')'
```

A function with a return value of the data type num.

Related information

For information about	See
Mathematical instructions and functions	<i>Technical reference manual - RAPID Overview, section RAPID Summary - Mathematics</i>

2 Functions

2.70 FileSize - Retrieve the size of a file

RobotWare Base

2.70 FileSize - Retrieve the size of a file

Usage

`FileSize` is used to retrieve the size of the specified file.

Basic examples

The following example illustrates the function `FileSize`.

See also [More examples on page 1274](#).

Example 1

```
PROC listfile(string filename)
  VAR num size;
  size := FileSize(filename);
  TPWrite filename+" size: "+NumToStr(size,0)+" Bytes";
ENDPROC
```

This procedure prints out the name of specified file together with a size specification.

Return value

Data type: num

The size in bytes.

Arguments

`FileSize (Path)`

Path

Data type: string

The file name specified with full or relative path.

Program execution

This function returns a numeric that specifies the size in bytes of the specified file.

It is also possible to get the same information about a directory.

Error handling

The following recoverable errors are generated and can be handled in an error handler. The system variable `ERRNO` will be set to:

Name	Cause of error
<code>ERR_FILEACC</code>	The file does not exist.

More examples

Basic example of the function is illustrated below.

Example 1

This example lists all files bigger than 1 KByte under the "HOME:" directory structure, including all subdirectories.

```
PROC searchdir(string dirname, string actionproc)
  VAR dir directory;
  VAR string filename;
```

Continues on next page

```

IF IsFile(dirname \Directory) THEN
  OpenDir directory, dirname;
  WHILE ReadDir(directory, filename) DO
    ! .. and . is the parent and resp. this directory
    IF filename <> ".." AND filename <> "." THEN
      searchdir dirname+"/"+filename, actionproc;
    ENDIF
  ENDWHILE
  CloseDir directory;
ELSE
  %actionproc% dirname;
ENDIF
ERROR
RAISE;
ENDPROC

PROC listfile(string filename)
  IF FileSize(filename) > 1024 THEN
    TPWrite filename;
  ENDIF
ENDPROC

PROC main()
  ! Execute the listfile routine for all files found under the
  ! tree of HOME:
  searchdir "HOME:", "listfile";
ENDPROC

```

This program traverses the directory structure under "HOME:" and for each file found it calls the `listfile` procedure. The `searchdir` is a generic part that knows nothing about the start of the search or which routine should be called for each file. It uses `IsFile` to check whether it has found a subdirectory or a file and it uses the late binding mechanism to call the procedure specified in `actionproc` for all files found. The `actionproc` routine `listfile` checks whether the file is bigger than 1KBytes.

Syntax

```

FileSize '('
  [ Path ':=' ] < expression (IN) of string> ')'

```

A function with a return value of the data type `num`.

Related information

For information about	See
Make a directory	MakeDir - Create a new directory on page 353
Remove a directory	RemoveDir - Delete a directory on page 602
Rename a file	RenameFile - Rename a file on page 607
Remove a file	RemoveFile - Delete a file on page 604
Copy a file	CopyFile - Copy a file on page 167

Continues on next page

2 Functions

2.70 FileSize - Retrieve the size of a file

RobotWare Base

Continued

For information about	See
Check file type	IsFile - Check the type of a file on page 1343
Check file system size	FSSize - Retrieve the size of a file system on page 1280
File and I/O device handling	<i>Application manual - Controller software IRC5</i>

2.71 FileTimeDnum - Retrieve time information about a file

Usage

`FileTimeDnum` is used to retrieve the last time for modification, access or file status change of a file. The time is measured in seconds since 00:00:00 GMT, Jan. 1 1970. The time is returned as a `dnum` and optionally also in a `stringdig`.

Basic example

The following example illustrates the function `FileTimeDnum`.
See also [More examples on page 1278](#).

Example 1

```
IF FileTimeDnum ("HOME:/mymod.mod" \ModifyTime) > ModTimeDnum
  ("mymod") THEN
  UnLoad "HOME:/mymod.mod";
  Load \Dynamic, "HOME:/mymod.mod";
ENDIF
```

This program reloads a module if the source file is newer. It uses the `ModTimeDnum` to retrieve the latest modify time for the specified module, and compares it to the `FileTimeDnum ("HOME:/mymod.mod" \ModifyTime)` at the source. Then, if the source is newer, the program unloads and loads the module again.

Return value

Data type: `dnum`

The time measured in seconds since 00:00:00 GMT, Jan. 1 1970.

Arguments

```
FileTimeDnum ( Path [\ModifyTime] | [\AccessTime] | [\StatCTime]
              [\StrDig])
```

Path

Data type: `string`

The file specified with a full or relative path.

[\ModifyTime]

Data type: `switch`

Last modification time.

[\AccessTime]

Data type: `switch`

Time of last access (read, execute or modify).

[\StatCTime]

Data type: `switch`

Last file status (access qualification) change time.

[\StrDig]

String Digit

Continues on next page

2 Functions

2.71 FileTimeDnum - Retrieve time information about a file

RobotWare Base

Continued

Data type: stringdig

To get the file time in a stringdig representation.

Program execution

For the specified file or directory, this function returns a numeric that specifies the time since the last:

- Modification
 - Access
 - File status change
-

Error handling

The following recoverable errors are generated and can be handled in an error handler. The system variable `ERRNO` will be set to:

Name	Cause of error
ERR_FILEACC	The file does not exist.

More examples

More examples of the function `FileTimeDnum` are illustrated below.

This is a complete example that implements an alert service for maximum 10 files.

```
LOCAL RECORD falert
  string filename;
  dnum ftime;
ENDRECORD

LOCAL VAR falert myfiles[10];
LOCAL VAR num currentpos:=0;
LOCAL VAR intnum timeint;

PROC alertInit(num freq)
  currentpos:=0;
  CONNECT timeint WITH mytrap;
  ITimer freq,timeint;
ENDPROC

LOCAL TRAP mytrap
  VAR num pos:=1;
  WHILE pos <= currentpos DO
    IF FileTimeDnum(myfiles{pos}.filename \ModifyTime) >
      myfiles{pos}.ftime THEN
      TPWrite "The file "+myfiles{pos}.filename+" is changed";
    ENDIF
    pos := pos+1;
  ENDWHILE
ENDTRAP

PROC alertNew(string filename)
  currentpos := currentpos+1;
```

Continues on next page

```

IF currentpos <= 10 THEN
  myfiles{currentpos}.filename := filename;
  myfiles{currentpos}.ftime := FileTimeDnum (filename
    \ModifyTime);
ENDIF
ENDPROC

PROC alertFree()
  IDelete timeint;
ENDPROC

```

Syntax

```

FileTimeDnum '('
[Path ':=' ] <expression (IN) of string>
['\' ModifyTime] |
['\' AccessTime] |
['\' StatCTime]
['\' StrDig ':=' <variable (VAR) of stringdig>]')'

```

A function with a return value of the data type dnum.

Related information

For information about	See
Last modify time of a loaded module	ModTimeDnum - Get file modify time for the loaded module on page 1369
String with only digits	stringdig - String with only digits on page 1763
Compare two strings with only digits	StrDigCmp - Compare two strings with only digits on page 1483

2 Functions

2.72 FSSize - Retrieve the size of a file system

RobotWare Base

2.72 FSSize - Retrieve the size of a file system

Usage

`FSSize` (*File System Size*) is used to retrieve the size of the file system in which a specified file resides. The size in bytes, kilo bytes or mega bytes are returned as a num.

Basic example

The following example illustrates the function `FSSize`.

See also [More examples on page 1281](#).

Example 1

```
PROC main()
  VAR num totalsyssize;
  VAR num freesyssize;
  freesyssize := FSSize("HOME:/spy.log" \Free);
  totalsyssize := FSSize("HOME:/spy.log" \Total);
  TPWrite NumToStr(((totalsyssize -
    freesyssize)/totalsyssize)*100,0) +" percent used";
ENDPROC
```

This procedure prints out the amount of disk space used on the `HOME:` file system as a percentage.

Return value

Data type: num

The size in bytes.

Arguments

```
FSSize (Name [\Total] | [\Free] [\Kbyte] [\Mbyte])
```

Name

Data type: string

The name of a file in the file system, specified with full or relative path.

[\Total]

Data type: switch

Retrieves the total amount of space in the file system.

[\Free]

Data type: switch

Retrieves the amount of free space in the file system.

[\Kbyte]

Data type: switch

Convert the number of bytes read to kilobytes, for example, divide the size with 1024.

Continues on next page

[\Mbyte]

Data type: switch

Convert the number of bytes read to megabytes, for example, divide the size with 1048576 (1024*1024).

Program execution

This function returns a numeric that specifies the size of the file system in which the specified file resides.

Error handling

The following recoverable errors are generated and can be handled in an error handler. The system variable `ERRNO` will be set to:

Name	Cause of error
ERR_FILEACC	The file system does not exist
ERR_FILESIZE	The size exceeds the max integer value for a num, 8388608

More examples

More examples of the function `FSSize` are illustrated below.

Example 1

```

LOCAL VAR intnum timeint;

LOCAL TRAP mytrap
  IF FSSize("HOME:/spy.log" \Free)/FSSize("HOME:/spy.log" \Total)
    <= 0.1 THEN
    TPWrite "The disk is almost full";
    alertFree;
  ENDIF
ENDTRAP

PROC alertInit(num freq)
  CONNECT timeint WITH mytrap;
  ITimer freq,timeint;
ENDPROC

PROC alertFree()
  IDelete timeint;
ENDPROC

```

This is a complete example for implementing an alert service that prints a warning on the FlexPendant when the remaining free space in the "HOME:" file system is less than 10%.

Syntax

```

FSSize '('
  [ Name ':=' ] < expression (IN) of string>
  [ '\ ' Total ] | [ '\ ' Free ]
  [ '\ ' Kbyte ]
  [ '\ ' Mbyte ] ')'

```

Continues on next page

2 Functions

2.72 FSSize - Retrieve the size of a file system

RobotWare Base

Continued

A function with a return value of the data type `num`.

Related information

For information about	See
Make a directory	MakeDir - Create a new directory on page 353
Remove a directory	RemoveDir - Delete a directory on page 602
Rename a file	RenameFile - Rename a file on page 607
Remove a file	RemoveFile - Delete a file on page 604
Copy a file	CopyFile - Copy a file on page 167
Check file type	IsFile - Check the type of a file on page 1343
Check file size	FileSize - Retrieve the size of a file on page 1274
File and I/O device handling	Application manual - Controller software IRC5

2.73 GetAxisDistance - Get the traversed distance counter of the axis

Usage

`GetAxisDistance` is used to read the current distance the axis has been moving since the last reset. If the axis is rotational the distance will be in degrees and if the axis is linear the distance will be in meters.

Basic examples

The following examples illustrate the function `GetAxisDistance`.

Example 1

```
PERS dnum distance;  
distance := GetAxisDistance(Track,1);
```

The total distance that axis 1 on mechanical unit `Track` has been moving since the last reset is stored in `distance`.

Example 2

```
PERS dnum distanceLimit := 1000;  
PERS dnum remaining;  
remaining := distanceLimit - GetAxisDistance(Track,1);
```

The remaining distance for axis 1 on mechanical unit `Track` is stored in `remaining`.

Return value

Data type: `dnum`

The return value is the distance, in meters or degrees, that the axis has moved since the last reset.

Arguments

```
GetAxisDistance (MechUnit AxisNo)
```

`MechUnit`

Mechanical Unit

Data type: `mecunit`

The name of the mechanical unit.

`AxisNo`

Data type: `num`

The number of the axis for which the traversed distance is to be read.

Prerequisites

`GetAxisDistance` can only return a value if the *Service Information System* configuration is done.

Example configuration

For the robot itself, configure the *SIS Parameters*.

For additional axes, configure the *SIS Single Parameters*.

Configure the type *Robot* to use the SIS configuration, with the parameter `use_sis`.

Continues on next page

2 Functions

2.73 GetAxisDistance - Get the traversed distance counter of the axis

RobotWare Base

Continued

Syntax

```
GetAxisDistance '('  
  [ MechUnit ':=' ] < variable (VAR) of mecunit > ','  
  [ AxisNo ':=' ] < variable (VAR) of num > ')'
```

A function with a return value of the data type dnum.

Related information

For information about	See
ResetAxisDistance	ResetAxisDistance - Reset the traversed distance information for the axis on page 611
ResetAxisMoveTime	ResetAxisMoveTime - Reset the move time counter of the axis on page 613
GetAxisMoveTime	GetAxisMoveTime - Get the move time counter of the axis on page 1285

2.74 GetAxisMoveTime - Get the move time counter of the axis

Usage

`GetAxisMoveTime` is used to read the current amount of time the axis has been moving since the last reset.

Basic examples

The following examples illustrate the function `GetAxisMoveTime`.

Example 1

```
PERS dnum movetime;
movetime := GetAxisMoveTime(Track,1);
```

The total amount of time that axis 1 on mechanical unit `Track` has been moving since the last reset is stored in `movetime`.

Example 2

```
PERS dnum timeLimit := 1000;
PERS dnum remaining;
remaining := timeLimit - GetAxisMoveTime(Track,1);
```

The remaining time for axis 1 on mechanical unit `Track` is stored in `remaining`.

Return value

Data type: `dnum`

The return value is the total amount of time in hours that the axis has been moving since the last reset.

Arguments

```
GetAxisMoveTime (MechUnit AxisNo)
```

`MechUnit`

Mechanical Unit

Data type: `mecunit`

The name of the mechanical unit.

`AxisNo`

Data type: `num`

The number of the axis for which the move time is to be read.

Syntax

```
GetAxisMoveTime '('
  [ MechUnit ':= ' ] < variable (VAR) of mecunit > ','
  [ AxisNo ':= ' ] < variable (VAR) of num > ')'
```

A function with a return value of the data type `dnum`.

Related information

For information about	See
ResetAxisDistance	ResetAxisDistance - Reset the traversed distance information for the axis on page 611

Continues on next page

2 Functions

2.74 GetAxisMoveTime - Get the move time counter of the axis

RobotWare Base

Continued

For information about	See
ResetAxisMoveTime	ResetAxisMoveTime - Reset the move time counter of the axis on page 613
GetAxisDistance	GetAxisDistance - Get the traversed distance counter of the axis on page 1283

2.75 GetMaxNumberOfCyclicBool - Get the maximum number of Cyclic bool conditions**Usage**

`GetMaxNumberOfCyclicBool` is used for retrieving the maximum number of Cyclic bool conditions that can be connected at the same time.

Basic examples

The following example illustrates the function `GetMaxNumberOfCyclicBool`.

Example 1

```
VAR num maxno := 0;
maxno := GetMaxNumberOfCyclicBool();
TPWrite "Maximum cyclic bool: " \Num:=maxno;
```

The maximum number of Cyclic bool conditions is displayed on the FlexPendant.

Return value

Data type: num

Syntax

```
GetMaxNumberOfCyclicBool '(' ' ')
```

A function with a return value of the data type num.

Related information

For information about	See
Setup a Cyclic bool condition	SetupCyclicBool - Setup a Cyclic bool condition on page 715
Remove a Cyclic bool condition	RemoveCyclicBool - Remove a Cyclic bool condition on page 600
Remove all Cyclic bool conditions	RemoveAllCyclicBool - Remove all Cyclic bool conditions on page 598
Cyclically evaluated logical conditions, Cyclic bool	<i>Application manual - Controller software IRC5</i>
Configuring Cyclic bool	<i>Technical reference manual - System parameters</i>

2 Functions

2.76 GetMecUnitName - Get the name of the mechanical unit

RobotWare Base

2.76 GetMecUnitName - Get the name of the mechanical unit

Usage

`GetMecUnitName` is used to get the name of a mechanical unit with one of the installed mechanical units as the argument. This function returns the mechanical units name as a string.

Basic examples

The following example illustrates the function `GetMecUnitName`.

Example 1

```
VAR string mecname;  
mecname:= GetMecUnitName(ROB1);
```

`mecname` is assigned the value "ROB1" as a string. All mechanical units (data type `mecunit`) such as `ROB1` are predefined in the system.

Return value

Data type: string

The return value will be the mechanical unit name as a string.

Arguments

```
GetMecUnitName ( MechUnit )
```

MechUnit

Mechanical Unit

Data type: `mecunit`

`MechUnit` takes one of the predefined mechanical units found in the configuration.

Syntax

```
GetMecUnitName '('  
  [ MechUnit ':= ' ] < variable (VAR) of mecunit > ')'
```

A function with a return value of the data type string.

Related information

For information about	See
Mechanical unit	mecunit - Mechanical unit on page 1690

2.77 GetModalPayloadMode - Get the ModalPayloadMode value

Usage

GetModalPayloadMode is used to get the ModalPayloadMode.

Basic examples

The following example illustrates the function GetModalPayloadMode.

Example 1

```
IF GetModalPayloadMode() = 1 THEN
  GripLoad piece1;
  MoveL p1, v1000, fine, gripper;
ELSE
  MoveL p1, v1000, fine, tool2 \TLoad:=gripperpiece1;
ENDIF
```

Read the ModalPayloadMode value from the system and depending on value, use different code to specify the load used in the movement instruction.

Return value

Data type: num

The return value will be the ModalPayloadMode setting as a num.

Syntax

```
GetModalPayloadMode '( ' )'
```

A function with a return value of the data type num.

Related information

For information about	See
System parameter <i>ModalPayloadMode</i> for activating and deactivating payload.	<i>Technical reference manual - System parameters</i>
Using payload in motion instructions.	MoveL - Moves the robot linearly on page 458

2 Functions

2.78 GetMotorTorque - Reads the current motor torque

RobotWare Base

2.78 GetMotorTorque - Reads the current motor torque

Usage

`GetMotorTorque` is used to read the current torque of the robot and external axes motors.

`GetMotorTorque` is primarily used to detect if a servo gripper holds a load or not.

Basic examples

The following example illustrates the function `GetMotorTorque`.

See also [More examples on page 1291](#).

Example 1

```
VAR num motor_torque2;  
motor_torque2 := GetMotorTorque(2);
```

The current motor torque of the second axis of the robot is stored in `motor_torque2`.

Return value

Data type: num

The current motor torque in newton metre (Nm) of the stated axis of the robot or external axes.

Arguments

```
GetMotorTorque [ \MecUnit ] AxisNo
```

`MecUnit`

Mechanical Unit

Data type: mecunit

The name of the mechanical unit for which an axis is to be read. If this argument is omitted, the axis for the connected robot is read.

`AxisNo`

Data type: num

The number of the axis to be read (1 - 6).

Program execution

The function reads the current filtered motor torque applied on the motors of the robot and external axes.

The motor torque value can also be seen as test signal number 2000 when using *TuneMaster*.

Error handling

The following recoverable errors are generated and can be handled in an error handler. The system variable `ERRNO` will be set to:

Name	Cause of error
<code>ERR_AXIS_PAR</code>	Parameter axis in function is wrong.

Continues on next page

More examples

The following examples illustrates the function `GetMotorTorque`.

Example 1

```
VAR num torque_value;
torque_value := GetMotorTorque(\MecUnit:=STN1, 1);
```

The current motor torque of the first axis of `STN1` is stored in `torque_value`.

Example 2

```
VAR num pre_grip_torque;
VAR num post_grip_torque;
..
MoveJ p10, v1000, fine, Gripper;
! Read the torque for axis 5 before gripping the piece
pre_grip_torque:=GetMotorTorque(5);
! Grip the piece
grip_piece;
! Read the torque for axis 5 after gripping the piece
post_grip_torque:=GetMotorTorque(5);
! Compare torque for axis 5 before and after gripping the piece
piece_gripped:=check_gripped_piece(pre_grip_torque,
    post_grip_torque);
IF piece_gripped = TRUE THEN
    GripLoad piece1;
ELSE
    TPWrite "Failed to grip the piece";
    Stop;
ENDIF
..
```

The current motor torque of axis 5 of the robot is read before gripping the piece. The piece is then gripped. The torque is read once again and the torques are compared to detect if there is an actual extra load in the gripper.

Limitations

The result of `GetMotorTorque` will vary depending on the gear friction, motor temperature etc. Two measurements in the same position can differ. As an example gearbox temperature can change the friction and thus the result.

The limitations described above can make it impossible to detect very small changes in the torque.

It is only possible to read the current torque for the mechanical units that are controlled from current program task. For a non-motion task, it is possible to read the torque for the mechanical units controlled by the connected motion task.

Syntax

```
GetMotorTorque '('
    ['\ ' MecUnit ' := ' < variable (VAR) of mecunit > ', ' ]
    [AxisNo ' := ' ] < expression (IN) of num > ')'
```

A function with a return value of the data type `num`.

Continues on next page

2 Functions

2.78 GetMotorTorque - Reads the current motor torque

RobotWare Base

Continued

Related information

For information about	See
Reads the current motor angles	ReadMotor - Reads the current motor angles on page 1429

2.79 GetNextCyclicBool - Get the names of all Cyclic bools

Usage

GetNextCyclicBool is used for retrieving the names of all Cyclic bools.

Basic examples

The following examples illustrates the function GetNextCyclicBool.

Example 1

```
VAR num listno := 0;
VAR string name;
...
WHILE GetNextCyclicBool(listno, name) DO
  TPWrite "Cyclic bool: "+name;
  ! listno := listno + 1 is done by GetNextCyclicBool
ENDWHILE
```

The names of all connected Cyclic bools in the system will be displayed on the FlexPendant.

Example 2

```
PERS bool cyclicflag1;
TASK PERS bool cyclicflag2;

PROC main()
  SetupCyclicBool cyclicflag1, di1=1 AND do2=1;
  SetupCyclicBool cyclicflag2, di3=1 AND do4=0;
  WHILE GetNextCyclicBool(listno, name) DO
    TPWrite name;
    ! listno := listno + 1 is done by GetNextCyclicBool
  ENDWHILE
  ...
```

cyclicflag1 and T_ROB1/cyclicflag1 will be displayed on the FlexPendant if the RAPID code is executed in T_ROB1 RAPID task.

Return value

Data type: bool

The return value is TRUE if a Cyclic bool name was found, otherwise FALSE.

Arguments

GetNextCyclicBool(ListNumber Name)

ListNumber

Data type: num

This specifies which Cyclic bool in the system internal list of Cyclic bool names that should be retrieved. At return, this variable is always incremented by one by the system to make it easy to access the next Cyclic bool name in the list. The first Cyclic bool name in the list has index 0.

Continues on next page

2 Functions

2.79 GetNextCyclicBool - Get the names of all Cyclic bools

RobotWare Base

Continued

Name

Data type: string

The name of the Cyclic bool persistent variable. If the persistent variable is defined as a TASK PERS, the name retrieved will be "TASK name/persistent boolean variable name".

Syntax

```
GetNextCyclicBool '('  
  [ ListNumber ':=' ] < variable (VAR) of num> ','  
  [ Name ':=' ] < variable (VAR) of string>  
' )'
```

A function with a return value of the data type bool.

Related information

For information about	See
Check if a persistent variable is a Cyclic bool	IsCyclicBool - Checks if a persistent variable is a Cyclic bool on page 1340
Setup a Cyclic bool condition	SetupCyclicBool - Setup a Cyclic bool condition on page 715
Remove a Cyclic bool condition	RemoveCyclicBool - Remove a Cyclic bool condition on page 600
Remove all Cyclic bool conditions	RemoveAllCyclicBool - Remove all Cyclic bool conditions on page 598
Cyclically evaluated logical conditions, Cyclic bool	<i>Application manual - Controller software IRC5</i>
Configuring Cyclic bool	<i>Technical reference manual - System parameters</i>

2.80 GetNextMechUnit - Get name and data for mechanical units

Usage

GetNextMechUnit (*Get Next Mechanical Unit*) is used for retrieving the name of mechanical units in the robot system. Besides the mechanical unit name, several optional properties of the mechanical unit can be retrieved.

Basic examples

The following example illustrates the function GetNextMechUnit.

See also [More examples on page 1296](#).

Example 1

```
VAR num listno := 0;
VAR string name := "";

TPWrite "List of mechanical units:";
WHILE GetNextMechUnit(listno, name) DO
  TPWrite name;
  ! listno := listno + 1 is done by GetNextMechUnit
ENDWHILE
```

The name of all mechanical units available in the system, will be displayed on the FlexPendant.

Return value

Data type: bool

TRUE if a mechanical unit was found, otherwise FALSE.

Arguments

```
GetNextMechUnit( ListNumber UnitName [\MecRef] [\TCPRob] [\NoOfAxes]
                [\MecTaskNo] [\MotPlanNo] [\Active] [\DriveModule]
                [\OKToDeact])
```

ListNumber

Data type: num

This specifies which items in the system internal list of mechanical units are to be retrieved. At return, this variable is always incremented by one by the system to make it easy to access the next unit in the list. The first mechanical unit in the list has index 0.

UnitName

Data type: string

The name of the mechanical unit.

[\MecRef]

Data type: mecunit

The system reference to the mechanical unit.

[\TCPRob]

Data type: bool

Continues on next page

2 Functions

2.80 GetNextMechUnit - Get name and data for mechanical units

RobotWare Base

Continued

TRUE if the mechanical unit is a TCP robot, otherwise FALSE.

[\NoOfAxes]

Data type: num

Number of axes for the mechanical unit. Integer value.

[\MecTaskNo]

Data type: num

The program task number that controls the mechanical unit. Integer value in range 1-20. If not controlling by any program task, -1 is returned.

This actual connection is defined in the system parameters domain controller (can in some application be redefined at runtime).

[\MotPlanNo]

Data type: num

The motion planner number that controls the mechanical unit. Integer value in range 1-6. If not controlling by any motion planner, -1 is returned.

This connection is defined in the system parameters domain controller.

[\Active]

Data type: bool

TRUE if the mechanical unit is active, otherwise FALSE.

[\DriveModule]

Data type: num

The Drive Module number 1 - 4 used by this mechanical unit.

[\OKToDeact]

Data type: bool

Return TRUE, if allowed to deactivate the mechanical unit from RAPID program.

More examples

More examples of the instruction `GetNextMechUnit` are illustrated below.

Example 1

```
VAR num listno := 4;
VAR string name := "";
VAR bool found := FALSE;

found := GetNextMechUnit (listno, name);
```

If `found` is set to TRUE, the name of mechanical unit number 4 will be in the variable `name`, else `name` contains only an empty string.

Syntax

```
GetNextMechUnit '('
  [ ListNumber ':' ] < variable (VAR) of num> ','
  [ UnitName ':' ] < variable (VAR) of string> ','
  [ '\ MecRef ':' ] < variable (VAR) of mecunit> ]
  [ '\ TCPRob ':' ] < variable (VAR) of bool> ]
```

Continues on next page

2.80 GetNextMechUnit - Get name and data for mechanical units

RobotWare Base

Continued

```
[ '\ ' NoOfAxes ':=' < variable (VAR) of num> ]
[ '\ ' MecTaskNo ':=' < variable (VAR) of num> ]
[ '\ ' MotPlanNo ':=' < variable (VAR) of num> ]
[ '\ ' Active ':=' < variable (VAR) of bool>]
[ '\ ' DriveModule ':=' < variable (VAR) of num>]
[ '\ ' OKToDeact ':=' < variable (VAR) of bool>]
')'
```

A function with a return value of the data type bool.

Related information

For information about	See
Mechanical unit	mecunit - Mechanical unit on page 1690
Activating/Deactivating mechanical units	ActUnit - Activates a mechanical unit on page 30 DeactUnit - Deactivates a mechanical unit on page 184
Characteristics of non-value data types	<i>Technical reference manual - RAPID Overview, section Basic Characteristics - Data types</i>

2 Functions

2.81 GetNextOption - Get name of options installed

2.81 GetNextOption - Get name of options installed

Usage

GetNextOption is for retrieving the options installed in the robot system.

Basic examples

The following example illustrates the function GetNextOption.

Example 1

```
VAR num listno:=0;
VAR string name;

TPWrite "List of options:";
  WHILE GetNextOption(listno, name) DO
    TPWrite " listno: "\Num:=listno;
    TPWrite " Option: "+name;
    ! listno := listno + 1 is done by GetNextOption
  ENDWHILE
```

The names of all options in the system will be displayed on the FlexPendant.

Return value

Data type: bool

TRUE if an option was found, otherwise FALSE.

Arguments

GetNextOption (ListNumber OptionName)

ListNumber

Data type: num

This specifies which item in the system-internal list of options that should be retrieved. On return, this variable is always incremented by one by the system, to make it easy to access the next option in the list. The first option in the list has index 0.

OptionName

Data type: string

The name of the option.

Syntax

```
GetNextOption '('
  [ ListNumber ':= ' ] < variable (VAR) of num> ', '
  [ OptionName ':= ' ] < variable (VAR) of string> ')'
```

A function with a return value of the data type bool.

2.82 GetNextSym - Get next matching symbol

Usage

GetNextSym (*Get Next Symbol*) is used together with SetDataSearch to retrieve data objects from the system.

Basic examples

The following example illustrates the function GetNextSym.

Example 1

```
VAR datapos block;
VAR string name;
VAR bool truevar:=TRUE;
...
SetDataSearch "bool" \Object:="my.*" \InMod:="mymod"\LocalSym;
WHILE GetNextSym(name,block) DO
  SetDataVal name\Block:=block,truevar;
ENDWHILE
```

This session will set all local bool data objects that begin with my in the module mymod to TRUE.

Return value

Data type: bool

TRUE if a new object has been retrieved, the object name and its enclosed block is then returned in its arguments.

FALSE if no more objects match.

Arguments

```
GetNextSym (Object Block [\Recursive])
```

Object

Data type: string

Variable (VAR or PERS) to store the name of the data object that will be retrieved.

Block

Data type: datapos

The enclosed block to the object.

[\Recursive]

Data type: switch

This will force the search to enter the block below, for example, if the search session has begun at the task level, it will also search modules and routines below the task.

Syntax

```
GetNextSym '('
  [ Object ':=' ] < variable or persistent (INOUT) of string > ','
  [ Block ':=' ] <variable (VAR) of datapos>
```

Continues on next page

2 Functions

2.82 GetNextSym - Get next matching symbol

RobotWare Base

Continued

```
[ '\ ' Recursive ] ' )'
```

A function with a return value of the data type `bool`.

Related information

For information about	See
Define a symbol set in a search session	SetDataSearch - Define the symbol set in a search sequence on page 696
Get the value of a data object	GetDataVal - Get the value of a data object on page 229
Set the value of a data object	SetDataVal - Set the value of a data object on page 701
Set the value of many data objects	SetAllDataVal - Set a value to all data objects in a defined set on page 692
The related data type <code>datapos</code>	datapos - Enclosing block for a data object on page 1646
<i>Advanced RAPID</i>	<i>Product specification - Controller software IRC5</i>

2.83 GetNumberOfCyclicBool - Get the number of Cyclic bool conditions

Usage

`GetNumberOfCyclicBool` is used for retrieving the number of connected Cyclic bool conditions.

Basic examples

The following example illustrates the function `GetNumberOfCyclicBool`.

Example 1

```
VAR num listno := 0;
listno := GetNumberOfCyclicBool();
TPWrite "Connected Cyclic bool: " \Num:=listno;
```

The number of connected Cyclic bool conditions is displayed on the FlexPendant.

Return value

Data type: num

Syntax

```
GetNumberOfCyclicBool '(' ' ')
```

A function with a return value of the data type num.

Related information

For information about	See
Setup a Cyclic bool condition	SetupCyclicBool - Setup a Cyclic bool condition on page 715
Remove a Cyclic bool condition	RemoveCyclicBool - Remove a Cyclic bool condition on page 600
Remove all Cyclic bool conditions	RemoveAllCyclicBool - Remove all Cyclic bool conditions on page 598
Cyclically evaluated logical conditions, Cyclic bool	Application manual - Controller software IRC5
Configuring Cyclic bool	Technical reference manual - System parameters

2 Functions

2.84 GetServiceInfo - Get service information from the system *RobotWare Base*

2.84 GetServiceInfo - Get service information from the system

Usage

`GetServiceInfo` is used to read service information from the system. This function returns the service information as a string.

Basic examples

The following example illustrates the function `GetServiceInfo`.
See also [More examples on page 1303](#).

Example 1

```
VAR string mystring;
VAR num mynum;
IF TaskRunRob() THEN
  mystring:=GetServiceInfo(ROB_ID \DutyTimeCnt);
  IF StrToVal(mystring, mynum) = FALSE THEN
    TPWrite "Conversion failed!";
    Stop;
  ENDIF
ENDIF
```

If the task controls a robot, use the predefined variable `ROB_ID` to read the duty time counter. Then convert the string value to a numeric value.

Return value

Data type: string

The value of the service information for the specified mechanical unit. Read more about the return values in *Arguments* below.

Arguments

```
GetServiceInfo (MechUnit [\DutyTimeCnt])
```

MechUnit

Mechanical Unit

Data type: mecunit

The name of the mechanical unit to get information for.

[\DutyTimeCnt]

Duty Time Counter

Data type: switch

Returns the duty time counter for the mechanical unit used in argument `MechUnit`. A string with "0" is returned if this option is used in the Virtual Controller.

The duty time counter is the value in hours that the mechanical unit has been in motors on and brakes have been released.

Program execution

Service information is read for the used optional parameter.

Continues on next page

More examples

More examples of how to use the function `GetServiceInfo` are illustrated below.

Example 1

```
VAR string mystring;
mystring:=GetServiceInfo(ROB_1 \DutyTimeCnt);
TPWrite "DutyTimeCnt for ROB_1: " + mystring;
mystring:=GetServiceInfo(ROB_2 \DutyTimeCnt);
TPWrite "DutyTimeCnt for ROB_2: " + mystring;
mystring:=GetServiceInfo(INTERCH \DutyTimeCnt);
TPWrite "DutyTimeCnt for INTERCH: " + mystring;
mystring:=GetServiceInfo(STN_1 \DutyTimeCnt);
TPWrite "DutyTimeCnt for STN_1: " + mystring;
mystring:=GetServiceInfo(STN_2 \DutyTimeCnt);
TPWrite "DutyTimeCnt for STN_2: " + mystring;
```

Get information about the duty time counter for all mechanical units in a multimove system, and write the values on the FlexPendant.

Syntax

```
GetServiceInfo '('
  [MechUnit ':=' ] <variable (VAR) of mecunit> ','
  ['\ DutyTimeCnt ] ')'
```

A function with a return value of the data type `string`.

Related information

For information about	See
Mechanical unit	mecunit - Mechanical unit on page 1690.

2 Functions

2.85 GetSignalOrigin - Get information about the origin of an I/O signal *RobotWare Base*

2.85 GetSignalOrigin - Get information about the origin of an I/O signal

Usage

GetSignalOrigin is used to get information about the origin of an I/O signal.

Basic examples

The following examples illustrate the function GetSignalOrigin:

Example 1

```
VAR signalorigin myorig;
VAR string signalname;
...
myorig:=GetSignalOrigin(mysignal, signalname);
IF myorig = SIGORIG_NONE THEN
  TPWrite "Signal cannot be used. AliasIO needed.";
ELSEIF myorig = SIGORIG_CFG THEN
  TPWrite "Signal "+signalname+" is defined in I/O configuration.";
ELSEIF myorig = SIGORIG_ALIAS THEN
  TPWrite "Signal is declared in RAPID.";
  TPWrite "Name according to the I/O configuration: "+signalname;
ENDIF
```

The code above can be used to determine the origin of the signal named `mysignal`.

Return value

Data type: `signalorigin`

The `signalorigin` as described in the table below.

Return value	Symbolic constant	Comment
0	SIGORIG_NONE	The I/O signal variable is declared in RAPID and has no alias coupling.
1	SIGORIG_CFG	The signal is configured in I/O configuration.
2	SIGORIG_ALIAS	The I/O signal variable is declared in RAPID and has an alias coupling to an I/O signal configured in I/O configuration.

Arguments

GetSignalOrigin Signal SignalName

Signal

Data type: `signalxx`

The signal name. Must be of data type `signaldo`, `signaldi`, `signalgo`, `signalgi`, `signalao`, or `signalai`.

SignalName

Data type: `string`

The signal name according to the I/O configuration, or empty string.

Continues on next page

Program execution

The function returns one of the following predefined signal origins: SIGORIG_NONE, SIGORIG_CFG, or SIGORIG_ALIAS.

If SIGORIG_NONE is returned, SignalName consists of an empty string.

If SIGORIG_CFG or SIGORIG_ALIAS is returned, the argument SignalName contains the I/O signal name according to the I/O configuration.

GetSignalOrigin can be used in generic programs to check if a signal has an alias coupling and if it is a coupling to the right physical I/O signal.

Syntax

```
GetSignalOrigin
  [Signal ':='] <variable (VAR) of anytype>','
  [SignalName ':='] <variable (VAR) of string>;'
```

Related information

For information about	See
Input/Output instructions	<i>Technical reference manual - RAPID Overview</i>
Input/Output functionality in general	<i>Technical reference manual - RAPID Overview</i>
Configuration of I/O	<i>Technical reference manual - System parameters</i>
Defining I/O signals with alias name	AliasIO - Define I/O signal with alias name on page 36
Resetting IO signal with alias name	AliasIOReset - Resetting I/O signal with alias name on page 39
Data type signalorigin	signalorigin - Describes the I/O signal origin on page 1745

2 Functions

2.86 GetSysInfo - Get information about the system

RobotWare Base

2.86 GetSysInfo - Get information about the system

Usage

`GetSysInfo` is used to read information about the system. The available information includes serial number, software version, software version name, robot type, controller ID, WAN IP address, controller language, and system name.

Basic examples

The following example illustrates the function `GetSysInfo`.

Example 1

```
VAR string serial;  
VAR string version;  
VAR string versionname;  
VAR string rtype;  
VAR string cid;  
VAR string lanip;  
VAR string clang;  
VAR string sysname;  
serial := GetSysInfo(\SerialNo);  
version := GetSysInfo(\SWVersion);  
versionname := GetSysInfo(\SWVersionName);  
rtype := GetSysInfo(\RobotType);  
cid := GetSysInfo(\CtrlId);  
lanip := GetSysInfo(\LanIp);  
clang := GetSysInfo(\CtrlLang);  
sysname := GetSysInfo(\SystemName);
```

Examples of returned strings:

Description	Variable	Return value
Serial number	serial	24-12345
Software version	version	ROBOTWARE_6.03.xxxx
Software version name	versionname	6.03.00.00
Robot number	rtype	IRB 2400-16/1.5 Type A
Controller ID	cid	MyRobot
WAN IP address	lanip	192.168.8.103
Controller language	clang	en
Active system	sysname	MySystem

Return value

Data type: `string`

The return value is a string with serial number, software version, software version name, robot type, controller ID, WAN IP address, controller language, and system name. Read more about the return values in [Arguments on page 1307](#) below.

Continues on next page

Arguments

```
GetSysInfo ([\SerialNo] | [\SWVersion] | [\SWVersionName] |
            [\RobotType] | [\CtrlId] | [\LanIp] | [\CtrlLang] |
            [\SystemName])
```

At least one of the arguments must be present.

[\SerialNo]

Serial Number

Data type: *switch*

Returns the serial number.

[\SWVersion]

Software Version

Data type: *switch*

Returns the RobotWare media version, as installed in the *PRODUCTS* folder.

[\SWVersionName]

Software Version Name

Data type: *switch*

Returns the RobotWare media version display name.

[\RobotType]

Data type: *switch*

Returns the robot type in the current or connected task. If the mechanical unit is not a TCP-robot, a dash (-) is returned.

[\CtrlId]

Controller ID

Data type: *switch*

Returns the controller ID. Returns an empty string if no controller ID is specified. The string *vc* is returned if used on a virtual controller.

[\LanIp]

Lan Ip address

Data type: *switch*

Returns the WAN IP address for the controller. The string *vc* is returned if used on a virtual controller. An empty string is returned if no WAN IP address is configured in the system.

[\CtrlLang]

Controller Language

Data type: *switch*

Returns the language used on the controller.

Return value	Language
cs	Czech
zh	Chinese (simplified Chinese, mainland Chinese)

Continues on next page

2 Functions

2.86 GetSysInfo - Get information about the system

RobotWare Base

Continued

Return value	Language
da	Danish
nl	Dutch
en	English
fi	Finnish
fr	French
de	German
hu	Hungarian
it	Italian
ja	Japanese
ko	Korean
pl	Polish
pt	Portuguese (Brazilian Portuguese)
ro	Romanian
ru	Russian
sl	Slovenian
es	Spanish
sv	Swedish
tr	Turkish

[\SystemName]

Data type: switch

Returns the active system name.

Syntax

```
GetSysInfo '('  
  ['\'SerialNo]  
  | ['\' SWVersion]  
  | ['\' SWVersionName]  
  | ['\' RobotType]  
  | ['\' CtrlId]  
  | ['\' LanIp]  
  | ['\' CtrlLang]  
  | ['\' SystemName]')'
```

A function with a return value of the data type `string`.

Related information

For information about	See
Test the identity of the system	IsSysId - Test system identity on page 1357

2.87 GetTaskName - Gets the name and number of current task

Usage

`GetTaskName` is used to get the identity of the current program task, with its name and number.

It is also possible from some *Non Motion Task* to get the name and number of its connected *Motion Task*. For *MultiMove System* the system parameter *Controller/Tasks/Use Mechanical Unit Group* define the connected *Motion Task* and in a base system the main task is always the connected *Motion Task* from any other task.

Basic examples

The following examples illustrate the function `GetTaskName`.

Example 1

```
VAR string taskname;
...
taskname := GetTaskName();
```

The current task name is returned in the variable `taskname`.

Example 2

```
VAR string taskname;
VAR num taskno;
...
taskname := GetTaskName(\TaskNo:=taskno);
```

The current task name is returned in the variable `taskname`. The integer identity of the task is stored in the variable `taskno`.

Example 3

```
VAR string taskname;
VAR num taskno;
...
taskname := GetTaskName(\MecTaskNo:=taskno);
```

If current task is a *Non Motion Task* task, the name of the connected motion task is returned in the variable `taskname`. The numerical identity of the connected motion task is stored in the variable `taskno`.

If current task controls some mechanical units, current task name is returned in the variable `taskname`. The numerical identity of the task is stored in the variable `taskno`.

Return value

Data type: `string`

The name of the task in which the function is executed or the name of the connected motion task.

Arguments

```
GetTaskName ( [\TaskNo] | [\MecTaskNo] )
```

Continues on next page

2 Functions

2.87 GetTaskName - Gets the name and number of current task

RobotWare Base

Continued

[\TaskNo]

Data type: num

Return current task name (same functionality if none of the switch \TaskNo or \MecTaskNo is used). Also get the identity of the current task represented as a integer value. The numbers returned will be in the range 1-20.

[\MecTaskNo]

Data type: num

Return connected motion task name or current motion task name. Also get the identity of connected or current motion task represented as a integer value. The numbers returned will be in the range 1-20.

Syntax

```
GetTaskName '('  
  [ \TaskNo ':= ' ] < variable (VAR) of num >  
  [ \MecTaskNo ':= ' ] < variable (VAR) of num > ')'
```

A function with a return value of the data type string.

Related information

For information about	See
Check if task run some TCP robot	TaskRunRob - Check if task controls some robot on page 1507
Multitasking	<i>Technical reference manual - RAPID Overview, section RAPID Overview - RAPID summary Multitasking</i> <i>Technical reference manual - RAPID Overview, section Basic characteristics - Multitasking</i>

2.88 GetTime - Reads the current time as a numeric value

Usage

`GetTime` is used to read a specified component of the current system time as a numeric value.

`GetTime` can be used to:

- have the program perform an action at a certain time
- perform certain activities on a weekday
- abstain from performing certain activities on the weekend
- respond to errors differently depending on the time of day.

Basic examples

The following example illustrates the function `GetTime`.

See also [More examples on page 1312](#).

Example 1

```
hour := GetTime(\Hour);
```

The current hour is stored in the variable `hour`.

Return value

Data type: num

One of the four time components specified below.

Arguments

```
GetTime ( [\WDay] | [\Hour] | [\Min] | [\Sec] | [\MSec] )
```

`[\WDay]`

Data type: switch

Return the current weekday. Range: 1 to 7 (Monday to Sunday).

`[\Hour]`

Data type: switch

Return the current hour. Range: 0 to 23.

`[\Min]`

Data type: switch

Return the current minute. Range: 0 to 59.

`[\Sec]`

Data type: switch

Return the current second. Range: 0 to 59.

`[\MSec]`

Data type: switch

Return the current millisecond. Range: 0 to 999.

One of the arguments must be specified, otherwise program execution stops with an error message.

Continues on next page

2 Functions

2.88 GetTime - Reads the current time as a numeric value

RobotWare Base

Continued

More examples

More examples of the function `GetTime` are illustrated below.

Example 1

```
weekday := GetTime(\WDay);
hour := GetTime(\Hour);
IF weekday < 6 AND hour >6 AND hour < 16 THEN
  production;
ELSE
  maintenance;
ENDIF
```

If it is a weekday and the time is between 7:00 and 15:59 the robot performs production. At all other times, the robot is in the maintenance mode.

Syntax

```
GetTime '('
  ['\ ' WDay ]
  | [ '\ ' Hour ]
  | [ '\ ' Min ]
  | [ '\ ' Sec ]
  | [ '\ ' MSec ] ')'

```

A function with a return value of the type `num`.

Related information

For information about	See
Time and date instructions	<i>Technical reference manual - RAPID Overview, section RAPID summary - System & time</i>
Setting the system clock	<i>Operating manual - IRC5 with FlexPendant, section Changing FlexPendant settings</i>

2.89 GetTorqueMargin - Reads the least torque margin

Usage

GetTorqueMargin is used to read the least torque margin since ResetTorqueMargin was executed and can be used on both robot and external axes.

Basic examples

The following examples illustrate the function GetTorqueMargin.

Example 1

```
VAR num torque_margin;
ResetTorqueMargin \AxisNo:=5;
! Insert Program Here
! ...
! ...
torque_margin := GetTorqueMargin (5);
```

The least torque margin, since the last execution of ResetTorqueMargin 5, from the axis 5 of the robot is stored in torque_margin.

Example 2

```
VAR num torque_margin1;
VAR num torque_margin2;
VAR num torque_margin3;

ResetTorqueMargin \AxisNo:=5;
! Insert Program Here
! ...
! ...
torque_margin1 := GetTorqueMargin (5);
ResetTorqueMargin 5;
! Change arm config
! Insert Program Here
! ...
! ...
torque_margin2 := GetTorqueMargin (5);
ResetTorqueMargin 5;
! Change arm config
! Insert Program Here
! ...
! ...
torque_margin3 := GetTorqueMargin (5);

! compare torque_margin1, torque_margin2, torque_margin3 etc
```

Return value

Data type: num

The least torque margin in % available torque since ResetTorqueMargin was executed.

Continues on next page

2 Functions

2.89 GetTorqueMargin - Reads the least torque margin

RobotWare Base

Continued

Arguments

GetTorqueMargin [\MecUnit] AxisNo

[\MecUnit]

Data type: mecunit

The name of the mechanical unit for which an axis is to be read. If this argument is omitted, the axis for the connected robot is read.

AxisNo

Data type: num

The number of the axis to be read (1 - 6).

Program execution

The function reads the least motor torque from the last `ResetTorqueMargin`.

The motor torque margin can also be read by the test signal number 4040. (This signal always shows the current torque margin.)

Limitations

When external forces affect the robot, care need to be taken not to overstress the structure. This method only reads the torque value on the motors.

Error handling

The following recoverable errors are generated and can be handled in an error handler. The system variable `ERRNO` will be set to:

ERR_AXIS_PAR	Parameter axis in function is wrong.
--------------	--------------------------------------

Syntax

```
GetTorqueMargin '('  
  [ '\ MechUnit ':= ] < variable (VAR) of mecunit > ','  
  [ '\ AxisNo ':= < expression (IN) of num > ] ')'
```

A function with a return value of the data type num.

Related information

For information about	See
Reset torque margin	ResetTorqueMargin - Reset least torque margin on page 617

2.90 GetTSPStatus - Get current task selection panel status

Usage

GetTSPStatus is used to check if a task is checked or unchecked in the Task Selection Panel on the FlexPendant.

Basic examples

The following example illustrates the function GetTSPStatus.

Example 1

```
VAR tsp_status tspstatus;
...
tspstatus:=GetTSPStatus("MYTASK");
IF tspstatus >= TSP_NORMAL_UNCHECKED AND tspstatus <=
    TSP_SEMISTATIC_UNCHECKED THEN
    TPWrite "Task MYTASK is unchecked in the Task Selection Panel";
ELSEIF tspstatus >= TSP_NORMAL_CHECKED THEN
    TPWrite "Task MYTASK is checked in the Task Selection Panel";
ELSE
    TPWrite "Task MYTASK is unchecked in TSP due to execution in
        service routine";
ENDIF
```

Check if program task MYTASK is checked or unchecked in the Task Selection Panel on the FlexPendant.

Return value

Data type: `tsp_status`

The current task selection panel status.

Arguments

GetTSPStatus (TaskRef | TaskName)

TaskRef

Data type: `taskid`

The program task identity of the task that should be checked.

The predefined variables of the data type `taskid` is available for all program tasks in the system.

The variable identity is "*taskname*"+"Id", for example the variable identity for the T_ROB1 task is T_ROB1Id.

TaskName

Data type: `string`

The program task name of the task that should be checked.

Predefined data

The following predefined symbolic constants of type `tsp_status` can be used to check the return value:

```
CONST tsp_status TSP_UNCHECKED_RUN_SERV_ROUT := 10;
```

Continues on next page

2 Functions

2.90 GetTSPStatus - Get current task selection panel status

RobotWare Base

Continued

```
CONST tsp_status TSP_NORMAL_UNCHECKED := 11;
CONST tsp_status TSP_STATIC_UNCHECKED := 12;
CONST tsp_status TSP_SEMISTATIC_UNCHECKED := 13;
CONST tsp_status TSP_NORMAL_CHECKED := 14;
CONST tsp_status TSP_STATIC_CHECKED := 15;
CONST tsp_status TSP_SEMISTATIC_CHECKED := 16;
```

Error handling

The following recoverable errors are generated and can be handled in an error handler. The system variable `ERRNO` will be set to:

ERR_TASKNAME	The program task name in argument <code>\TaskName</code> cannot be found in the system.
--------------	---

Syntax

```
GetTSPStatus '('
  [ TaskRef ':= ' ] <variable (VAR) of taskid>
  |[ TaskName ':= ' ] <expression (IN) of string> ')'
```

A function with a return value of the data type `tsp_status`.

Related information

For information about	See
Task selection panel status	tsp_status - Task selection panel status on page 1797
Check if a normal task is active	TasksActive - Check if a normal task is active on page 1510

2.91 GetUASUserName - Get user name of logged in user

Usage

GetUASUserName is used to get the user name of the user currently logged in from the FlexPendant.

Basic examples

The following example illustrates the function GetUASUserName.

Example 1

```
VAR string strUser;
...
strUser := GetUASUserName();
```

The user name of the currently logged in user is returned in the variable `strUser`.

Return value

Data type: `string`

The user name of the currently logged in user.

Error handling

The following recoverable errors are generated and can be handled in an error handler. The system variable `ERRNO` will be set to:

Name	Cause of error
ERR_TP_NO_CLIENT	There is no user logged in on the FlexPendant, i.e no FlexPendant is currently in use.

More examples

The following example illustrates the function GetUASUserName.

See also [More examples on page 1317](#).

Example 1

```
VAR string user_name:="No user";
...
IF UIClientExist() = TRUE THEN
  user_name:=GetUASUserName();
ENDIF
```

The user name of the currently logged in user is returned in the variable `user_name`. If running without any FlexPendant, the `user_name` contains the string "No user".

Syntax

```
GetUASUserName(' ')
```

A function with a return value of the data type `string`.

Related information

For information about	See
User Authorization System (UAS)	<i>Operating manual - RobotStudio</i>

Continues on next page

2 Functions

2.91 GetUASUserName - Get user name of logged in user

RobotWare Base

Continued

For information about	See
Check if user client exists	UIClientExist - Exist User Client on page 1543

2.92 GInput - Read value of group input signal

Usage

GInput is used to read the current value of a group of digital input signals.



Note

Note that the function GInput is a legacy function that no longer has to be used. See the examples for an alternative and recommended way of programming.

Basic examples

The following example illustrates the function GInput.

Example 1

```
IF GInput(gi2) = 5 THEN ...
...
IF gi2 = 5 THEN ...
```

If the current value of the signal gi2 is equal to 5, then ...

Return value

Data type: num

The current value of the signal (a positive integer).

The values of each signal in the group are read and interpreted as an unsigned binary number. This binary number is then converted to an integer.

The value returned lies within a range that is dependent on the number of signals in the group.

Number of signals	Allowed value
1	0-1
2	0-3
3	0-7
4	0-15
5	0-31
6	0-63
7	0-127
8	0-255
9	0-511
10	0-1023
11	0-2047
12	0-4095
13	0-8191
14	0-16383
15	0-32767
16	0-65535

Continues on next page

2 Functions

2.92 GInput - Read value of group input signal

RobotWare Base

Continued

Number of signals	Allowed value
17	0-131071
18	0-262143
19	0-524287
20	0-1048575
21	0-2097151
22	0-4194303
23	0-8388607

Arguments

GInput (Signal)

Signal

Data type: signalgi

The name of the signal group to be read.

Syntax

```
GInput '('  
    [Signal ':='] <variable (VAR) of signalgi>')'
```

A function with a return value of data type num.

Related information

For information about	See
Read value of group input signal with more than 23 bits	GInputDnum - Read value of group input signal on page 1321
Input/Output instructions	<i>Technical reference manual - RAPID Overview, section RAPID Summary - Input and Output Signals</i>
Input/Output functionality in general	<i>Technical reference manual - RAPID Overview, section Motion and I/O Principles - I/O principles</i>
Configuration of I/O	<i>Technical reference manual - System parameters</i>

2.93 GInputDnum - Read value of group input signal

Usage

GInputDnum is used to read the current value of a group of digital input signals larger than 23 bits.

Basic examples

The following examples illustrate the function GInputDnum.

Example 1

```
IF GInputDnum(gi2) = 55 THEN ...
```

If the current value of the signal gi2 is equal to 55, then ...

Example 2

```
IF GInputDnum(gi2) = 4294967295 THEN ...
```

If the current value of the signal gi2 is equal to 4294967295, then ...

Return value

Data type: dnum

The current value of the signal (a positive integer).

The values of each signal in the group are read and interpreted as an unsigned binary number. This binary number is then converted to an integer.

The value returned lies within a range that is dependent on the number of signals in the group.

Number of signals	Allowed value
1	0-1
2	0-3
3	0-7
4	0-15
5	0-31
6	0-63
7	0-127
8	0-255
9	0-511
10	0-1023
11	0-2047
12	0-4095
13	0-8191
14	0-16383
15	0-32767
16	0-65535
17	0-131071
18	0-262143

Continues on next page

2 Functions

2.93 GInputDnum - Read value of group input signal

RobotWare Base

Continued

Number of signals	Allowed value
19	0-524287
20	0-1048575
21	0-2097151
22	0-4194303
23	0-8388607
24	0-16777215
25	0-33554431
26	0-67108863
27	0-134217727
28	0-268435455
29	0-536870911
30	0-1073741823
31	0-2147483647
32	0-4294967295

Arguments

GInputDnum (Signal)

Signal

Data type: signalgi

The name of the signal group to be read.

Error handling

The following recoverable errors are generated and can be handled in an error handler. The system variable `ERRNO` will be set to:

Name	Cause of error
ERR_NO_ALIASIO_DEF	The signal variable is a variable declared in RAPID. It has not been connected to an I/O signal defined in the I/O configuration with instruction <code>AliasIO</code> .
ERR_NORUNUNIT	There is no contact with the I/O device.
ERR_SIG_NOT_VALID	The I/O signal cannot be accessed. The reasons can be that the I/O device is not running or an error in the configuration (only valid for ICI field bus).

Syntax

```
GInputDnum '('  
  [ Signal ':=' ] < variable (VAR) of signalgi > ')'
```

A function with a return value of data type `dnum`.

Related information

For information about	See
Read value of group input signal	GInput - Read value of group input signal on page 1319

Continues on next page

2.93 GInputDnum - Read value of group input signal

RobotWare Base

Continued

For information about	See
Input/Output instructions	<i>Technical reference manual - RAPID Overview, section RAPID Summary - Input and Output Signals</i>
Input/Output functionality in general	<i>Technical reference manual - RAPID Overview, section Motion and I/O Principles - I/O principles</i>
Configuration of I/O	<i>Technical reference manual - System parameters</i>

2 Functions

2.94 GOutput - Reads the value of a group of digital output signals

RobotWare Base

2.94 GOutput - Reads the value of a group of digital output signals

Usage

GOutput is used to read the current value of a group of digital output signals.

Basic examples

The following example illustrates the function GOutput.

Example 1

```
IF GOutput(go2) = 5 THEN ...
```

If the current value of the signal go2 is equal to 5, then ...

Return value

Data type: num

The current value of the signal (a positive integer).

The values of each signal in the group are read and interpreted as an unsigned binary number. This binary number is then converted to an integer.

The value returned lies within a range that is dependent on the number of signals in the group.

No. of signals	Permitted value
1	0-1
2	0-3
3	0-7
4	0-15
5	0-31
6	0-63
7	0-127
8	0-255
9	0-511
10	0-1023
11	0-2047
12	0-4095
13	0-8191
14	0-16383
15	0-32767
16	0-65535
17	0-131071
18	0-262143
19	0-524287
20	0-1048575
21	0-2097151

Continues on next page

2.94 GOutput - Reads the value of a group of digital output signals

RobotWare Base

Continued

No. of signals	Permitted value
22	0-4194303
23	0-8388607

Arguments

GOutput (Signal)

Signal

Data type: signalgo

The name of the signal group to be read.

Error handling

The following recoverable errors are generated and can be handled in an error handler. The system variable `ERRNO` will be set to:

Name	Cause of error
ERR_NO_ALIASIO_DEF	The signal variable is a variable declared in RAPID. It has not been connected to an I/O signal defined in the I/O configuration with instruction <code>AliasIO</code> .
ERR_NORUNUNIT	There is no contact with the I/O device.
ERR_SIG_NOT_VALID	The I/O signal cannot be accessed. The reasons can be that the I/O device is not running or an error in the configuration (only valid for ICI field bus).

Syntax

```
GOutput '('
  [ Signal ':=' ] < variable (VAR) of signalgo > ')'
```

A function with a return value of data type `num`.

Related information

For information about	See
Set an output signal group	SetGO - Changes the value of a group of digital output signals on page 707
Read a group of output signals	GOutputDnum - Read value of group output signal on page 1326
Read a group of input signals	GInputDnum - Read value of group input signal on page 1321
Input/Output instructions	<i>Technical reference manual - RAPID Overview, section RAPID Summary - Input and Output Signals</i>
Input/Output functionality in general	<i>Technical reference manual - RAPID Overview, section Motion and I/O Principles - I/O Principles</i>
Configuration of I/O	<i>Technical reference manual - System parameters</i>

2 Functions

2.95 GOutputDnum - Read value of group output signal

RobotWare Base

2.95 GOutputDnum - Read value of group output signal

Usage

GOutputDnum is used to read the current value of a group of digital output signals larger than 23 bits.

Basic examples

The following examples illustrate the function GOutputDnum.

Example 1

```
IF GOutputDnum(go2) = 55 THEN ...
```

If the current value of the signal go2 is equal to 55, then ...

Example 2

```
IF GOutputDnum(go2) = 4294967295 THEN ...
```

If the current value of the signal go2 is equal to 4294967295, then ...

Return value

Data type: dnum

The current value of the signal (a positive integer).

The values of each signal in the group are read and interpreted as an unsigned binary number. This binary number is then converted to an integer.

The value returned lies within a range that is dependent on the number of signals in the group.

Number of signals	Allowed value
1	0-1
2	0-3
3	0-7
4	0-15
5	0-31
6	0-63
7	0-127
8	0-255
9	0-511
10	0-1023
11	0-2047
12	0-4095
13	0-8191
14	0-16383
15	0-32767
16	0-65535
17	0-131071
18	0-262143

Continues on next page

Number of signals	Allowed value
19	0-524287
20	0-1048575
21	0-2097151
22	0-4194303
23	0-8388607
24	0-16777215
25	0-33554431
26	0-67108863
27	0-134217727
28	0-268435455
29	0-536870911
30	0-1073741823
31	0-2147483647
32	0-4294967295

Arguments

GOutputDnum (Signal)

Signal

Data type: signalgo

The name of the signal group to be read.

Error handling

The following recoverable errors are generated and can be handled in an error handler. The system variable `ERRNO` will be set to:

Name	Cause of error
ERR_NO_ALIASIO_DEF	The signal variable is a variable declared in RAPID. It has not been connected to an I/O signal defined in the I/O configuration with instruction <code>AliasIO</code> .
ERR_NORUNUNIT	There is no contact with the I/O device.
ERR_SIG_NOT_VALID	The I/O signal cannot be accessed. The reasons can be that the I/O device is not running or an error in the configuration (only valid for ICI field bus).

Syntax

```
GOutputDnum '('
  [ Signal ':=' ] < variable (VAR) of signalgo > ')'
```

A function with a return value of data type `dnum`.

Related information

For information about	See
Set an output signal group	SetGO - Changes the value of a group of digital output signals on page 707

Continues on next page

2 Functions

2.95 GOutputDnum - Read value of group output signal

RobotWare Base

Continued

For information about	See
Input/Output instructions	<i>Technical reference manual - RAPID overview, section RAPID Summary - Input and Output Signals</i>
Input/Output functionality in general	<i>Technical reference manual - RAPID overview, section Motion and I/O Principles</i>
Configuration of I/O	<i>Technical reference manual - System parameters</i>

2.96 HexToDec - Convert from hexadecimal to decimal

Usage

`HexToDec` is used to convert a number specified in a readable string in the base 16 to the base10.

The input string should be constructed from the character set [0-9,A-F,a-f].

This routine handle numbers from 0 up to 9223372036854775807dec or 7FFFFFFFFFFFFFFF hex.

Basic examples

The following example illustrates the function `HexToDec`.

Example 1

```
VAR string str;

str := HexToDec("5F5E0FF");
```

The variable `str` is given the value "99999999".

Return value

Data type: string

The string converted to a decimal representation of the given number in the inparameter string.

Arguments

```
HexToDec ( Str )
```

Str

String

Data type: string

The string to convert.

Syntax

```
HexToDec '('  
  [ Str ':=' ] <expression (IN) of string> ')'
```

A function with a return value of the data type string.

Related information

For information about	See
String functions	<i>Technical reference manual - RAPID Overview, section RAPID summary - String functions</i>
Definition of string	string - Strings on page 1761
String values	<i>Technical reference manual - RAPID Overview, section Basic characteristics - Basic elements</i>

2 Functions

2.97 IndInpos - Independent axis in position status

Independent Axis

2.97 IndInpos - Independent axis in position status

Usage

IndInpos is used to test whether an independent axis has reached the selected position.

Basic examples

The following example illustrates the function IndInpos.

Example 1

```
IndAMove Station_A,1\ToAbsNum:=90,20;  
WaitUntil IndInpos(Station_A,1) = TRUE;  
WaitTime 0.2;
```

Wait until axis 1 of Station_A is in the 90 degrees position.

Return value

Data type: bool

The table describes the return values from IndInpos:

Return value	Axis status
TRUE	In position and has zero speed.
FALSE	Not in position and/or has not zero speed.

Arguments

```
IndInpos ( MecUnit Axis )
```

MecUnit

Mechanical Unit

Data type: mecunit

The name of the mechanical unit.

Axis

Data type: num

The number of the current axis for the mechanical unit (1-6).

Error handling

The following recoverable errors are generated and can be handled in an error handler. The system variable ERRNO will be set to:

Name	Cause of error
ERR_AXIS_ACT	The axis is not activated.
ERR_AXIS_IND	The axis is not in independent mode.

Limitations

An independent axis executed with the instruction IndCMove always returns the value FALSE, even when the speed is set to zero.

Continues on next page

A wait period of 0.2 seconds should be added after the instruction, to ensure that the correct status has been achieved. This time period should be longer for external axes with poor performance.

Syntax

```
IndInpos '('
  [MecUnit ':=' ] <variable (VAR) of mecunit> ','
  [Axis ':=' ] <expression (IN) of num> ')'
```

A function with a return value of the data type `bool`.

Related information

For information about	See
Independent axes in general	<i>Technical reference manual - RAPID Overview, section Motion and I/O Principles - Positioning during program execution</i>
Other independent instruction and functions	<i>Technical reference manual - RAPID Overview, section RAPID summary - Motion</i>
Check the speed status for independent axes	IndSpeed - Independent speed status on page 1332
Activating independent joints	<i>Technical reference manual - System parameters, topic Motion, type Arm</i>

2 Functions

2.98 IndSpeed - Independent speed status *Independent Axis*

2.98 IndSpeed - Independent speed status

Usage

IndSpeed is used to test whether an independent axis has reached the selected speed.

Basic examples

The following example illustrates the function IndSpeed.

Example 1

```
IndCMove Station_A, 2, 3.4;  
WaitUntil IndSpeed(Station_A,2 \InSpeed) = TRUE;  
WaitTime 0.2;
```

Wait until axis 2 of Station_A has reached the speed 3.4 degrees/s.

Return value

Data type: bool

The table describes the return values from IndSpeed \IndSpeed:

Return value	Axis status
TRUE	Has reached the selected speed.
FALSE	Has not reached the selected speed.

The table describes the return values from IndSpeed \ZeroSpeed:

Return value	Axis status
TRUE	Zero speed.
FALSE	Not zero speed

Arguments

```
IndSpeed ( MecUnit Axis [ \InSpeed ] | [ \ZeroSpeed ] )
```

MecUnit

Mechanical Unit

Data type: mecunit

The name of the mechanical unit.

Axis

Data type: num

The number of the current axis for the mechanical unit (1-6).

[\InSpeed]

Data type: switch

IndSpeed returns value TRUE if the axis has reached the selected speed otherwise FALSE.

[\ZeroSpeed]

Data type: switch

Continues on next page

IndSpeed returns value `TRUE` if the axis has zero speed otherwise `FALSE`.

If both the arguments `\InSpeed` and `\ZeroSpeed` are omitted, an error message will be displayed.

Error handling

The following recoverable errors are generated and can be handled in an error handler. The system variable `ERRNO` will be set to:

Name	Cause of error
<code>ERR_AXIS_ACT</code>	The axis is not activated.
<code>ERR_AXIS_IND</code>	The axis is not in independent mode.

Limitation

The function `IndSpeed\InSpeed` will always return the value `FALSE` in the following situations:

- The robot is in manual mode with reduced speed.
- The speed is reduced using the `VelSet` instruction.
- The speed is reduced from the production window.

A wait period of 0.2 seconds should be added after the instruction to ensure that the correct status is obtained. This time period should be longer for external axes with poor performance.

Syntax

```
IndSpeed '('
  [MecUnit ':=' ] <variable (VAR) of mecunit> ','
  [Axis ':=' ] <expression (IN) of num>
  ['\ ' InSpeed] | ['\ ' ZeroSpeed] )'
```

A function with a return value of the data type `bool`.

Related information

For information about	See
Independent axes in general	<i>Technical reference manual - RAPID Overview, section Motion and I/O principles - Positioning during program execution</i>
Other independent instruction and functions	<i>Technical reference manual - RAPID Overview, section RAPID summary - Motion</i>
More examples	IndCMove - Independent continuous movement on page 266
Check the position status for independent axes	IndInpos - Independent axis in position status on page 1330
Activating independent joints	<i>Technical reference manual - System parameters, topic Motion, type Arm</i>

2 Functions

2.99 IOUnitState - Get current state of I/O device

RobotWare Base

2.99 IOUnitState - Get current state of I/O device

Usage

IOUnitState is used to find out the current state of an I/O device. It is physical state and logical state define the status for an I/O device.

Basic examples

The following examples illustrate the function IOUnitState.

Example 1

```
IF (IOUnitState("UNIT1" \Phys)=IOUNIT_PHYS_STATE_RUNNING) THEN
  ! Possible to access some signal on the I/O unit
ELSE
  ! Read/Write some signal on the I/O unit result in error
ENDIF
```

Test is done to see if the I/O device UNIT1 is up and running.

Example 2

```
IF (IOUnitState("UNIT1" \Logic)=IOUNIT_LOG_STATE_DISABLED) THEN
  ! Unit is disabled by user from RAPID or FlexPendant
ELSE
  ! Unit is enabled.
ENDIF
```

Test is done to see if the I/O device UNIT1 is disabled.

Return value

Data type: iounit_state

The return value has different values depending on if the optional arguments \Logic or \Phys or no optional argument at all is used.

The I/O device logical states describes the state a user can order the I/O device into. The state of the I/O device as defined in the table below when using optional argument \Logic.

Return value	Symbolic constant	Comment
10	IOUNIT_LOG_STATE_DISABLED	I/O device is disabled by user from RAPID, FlexPendant or System Parameters.
11	IOUNIT_LOG_STATE_ENABLED	I/O device is enabled by user from RAPID, FlexPendant or System Parameters. Default after startup.

When the I/O device is logically enabled by the user and the fieldbus driver intends to take an I/O device into physical state IOUNIT_PHYS_STATE_RUNNING, the I/O device could get into other states for various reasons (see table below).

Continues on next page

The state of the I/O device as defined in the table below when using optional argument `\Phys`.

Return value	Symbolic constant	Comment
20	IOUNIT_PHYS_STATE_DEACTIVATED	I/O device is not running, disabled by user
21	IOUNIT_PHYS_STATE_RUNNING	I/O device is running
22	IOUNIT_PHYS_STATE_ERROR	I/O device is not working because of some runtime error
23	IOUNIT_PHYS_STATE_UNCONNECTED	I/O device is configured but not connected to the I/O network or the I/O network is stopped.
24	IOUNIT_PHYS_STATE_UNCONFIGURED	I/O device is not configured but connected to the I/O network. ¹⁾
25	IOUNIT_PHYS_STATE_STARTUP	I/O device is in start up mode. ¹⁾
26	IOUNIT_PHYS_STATE_INIT	I/O device is created. ¹⁾



Note

The state of the I/O device is defined in the table below when not using any of the optional arguments `\Phys` or `\Logic`.

Return value	Symbolic constant	Comment
1	IOUNIT_RUNNING	I/O device is up and running
2	IOUNIT_RUNERROR	I/O device is not working because of some runtime error
3	IOUNIT_DISABLE	I/O device is disabled by user from RAPID or FlexPendant
4	IOUNIT_OTHERERR	Other configuration or startup errors

¹⁾ Not possible to get this state in the RAPID program with current version of RobotWare - OS.

Arguments

```
IOUnitState (UnitName [\Phys] | [\Logic])
```

UnitName

Data type: string

The name of the I/O device to be checked (with same name as configured).

[\Phys]

Physical

Data type: switch

If using this parameter the physical state of the I/O device is read.

Continues on next page

2 Functions

2.99 IOUnitState - Get current state of I/O device

RobotWare Base

Continued

[\Logic]

Logical

Data type: switch

If using this parameter the logical state of the I/O device is read.

Syntax

```
IOUnitState '('  
  [ UnitName ':=' ] < expression (IN) of string >  
  [ '\ ' Phys ] | [ '\ ' Logic ] ')'
```

A function with a return value of the data type `iounit_state`.

Related information

For information about	See
State of I/O device	iounit_state - State of I/O device on page 1678
Enable an I/O device	IOEnable - Activate an I/O device on page 292
Disabling an I/O device	IODisable - Deactivate an I/O device on page 289
Input/Output instructions	<i>Technical reference manual - RAPID Overview, section RAPID Summary - Input and Output Signals</i>
Input/Output functionality in general	<i>Technical reference manual - RAPID Overview, section Motion and I/O Principles - I/O Principles</i>
Configuration of I/O	<i>Technical reference manual - System parameters</i>

2.100 IsBrakeCheckActive - Test if brake check is running

Usage

`IsBrakeCheckActive` is used to test if there is an ongoing brake test, i.e. if any of the `CyclicBrakeCheck` or `BrakeCheck` procedures are active (executing or stopped) on any execution level.

Basic examples

The following example illustrates the function `IsBrakeCheckActive`.

Example 1

```
WHILE IsBrakeCheckActive() = TRUE THEN
  WaitTime 1;
ENDWHILE
...
```

Test to see if a brake test routine is active. If it is active, then wait until it is ready.

Return value

Data type: `bool`

The function returns `TRUE` if there is an ongoing brake test.

Syntax

```
IsBrakeCheckActive '(' '')
```

A function with a return value of the data type `bool`.

Related information

For information about	See
<code>BrakeCheck</code>	<i>Operating manual - IRC5 with FlexPendant</i>

2 Functions

2.101 IsCollFree - Checks if position would collide

RobotWare Base

2.101 IsCollFree - Checks if position would collide

Usage

`IsCollFree` is used to test whether the robot would collide if positioned in a joint position, provided as an argument to the function. In *MultiMove* systems, several joint positions for different robots can be provided.

Basic examples

The following example illustrates the function `IsCollFree`.

Example 1

```
IF IsCollFree(testpos) THEN
  MoveAbsJ testpos, v50, fine, tool1;
ENDIF
```

Checks if the position (jointtarget) `testpos` is a collision free position before moving there.

Example 2

```
IF IsCollFree(testpos1 \Rob2Pos:=testpos2 \Rob3Pos:=testpos3) THEN
  TPWrite "No collisions"
ENDIF
```

Assumed that the calling RAPID task controls `Rob1`. Checks if the positions `testpos1` for `Rob1`, `testpos2` for `Rob2` and `testpos3` for `Rob3` will result in a collision or not.

Return value

Data type: `bool`

The function returns `TRUE` if the specified joint positions will not result in a collision, otherwise `FALSE`.

Arguments

```
IsCollFree ThisRobotPos [\Rob1Pos] [\Rob2Pos] [\Rob3Pos] [\Rob4Pos]
```

`ThisRobotPos`

Data type: `jointtarget`

The position that is checked whether it is collision free or not. For the robot controlled by the calling RAPID task.

`Rob1Pos`

Data type: `jointtarget`

Checking if collision when also `Rob1` has position `Rob1Pos` in *MultiMove* systems. Cannot be set if the calling RAPID task controls `Rob1`, since then `ThisRobotPos` specifies the position of that robot.

`Rob2Pos`

Data type: `jointtarget`

Continues on next page

Checking if collision when also Rob2 has position `Rob2Pos` in *MultiMove* systems. Cannot be set if the calling RAPID task controls Rob2, since then `ThisRobotPos` specifies the position of that robot.

`Rob3Pos`

Data type: `jointtarget`

Checking if collision when also Rob3 has position `Rob3Pos` in *MultiMove* systems. Cannot be set if the calling RAPID task controls Rob3, since then `ThisRobotPos` specifies the position of that robot.

`Rob4Pos`

Data type: `jointtarget`

Checking if collision when also Rob4 has position `Rob4Pos` in *MultiMove* systems. Cannot be set if the calling RAPID task controls Rob4, since then `ThisRobotPos` specifies the position of that robot.

Limitations

- If *MultiMove* system and an optional argument is not provided, the function will use the measured position of the robot. To get reliable results, the robots not provided in `IsCollFree` should be standing still.
- Does not check if the movement to the position provided will result in a collision. As in Example 1 above, the position `testpos` can be collision free, but the movement towards that position can result in a collision.

Syntax

```
IsCollFree '('
  [ ThisRobotPos ':' ] < expression (IN) of jointtarget > ','
  [ '\ ' Rob1Pos ':' < expression (IN) of jointtarget > ]
  [ '\ ' Rob2Pos ':' < expression (IN) of jointtarget > ]
  [ '\ ' Rob3Pos ':' < expression (IN) of jointtarget > ]
  [ '\ ' Rob4Pos ':' < expression (IN) of jointtarget > ]
  ')'
```

A function with a return value of the data type `bool`.

Related information

For information about	See
Collision prediction	<i>Application manual - Controller software IRC5</i>

2 Functions

2.102 IsCyclicBool - Checks if a persistent variable is a Cyclic bool

RobotWare Base

2.102 IsCyclicBool - Checks if a persistent variable is a Cyclic bool

Usage

IsCyclicBool is used to test if a persistent boolean is a Cyclic bool or not, i.e. if a logical condition has been connected to the persistent boolean variable with the instruction **SetupCyclicBool**.

Basic examples

The following examples illustrate the function **IsCyclicBool**.

Example 1

```
PERS bool cyclicflag1;

PROC main()
  TPWrite "cyclicflag1 is a cyclic bool:
          "\Bool:=IsCyclicBool(cyclicflag1);
  SetupCyclicBool cyclicflag1, dil=1 AND do2=1;
  TPWrite "cyclicflag1 is a cyclic bool:
          "\Bool:=IsCyclicBool(cyclicflag1);
  ...
```

The text **cyclicflag1 is a cyclic bool: FALSE** is first written on the FlexPendant. After execution of **SetupCyclicBool** the persistent boolean variable is a Cyclic bool, and the second text will be **cyclicflag1 is a cyclic bool: TRUE**.

Example 2

```
TASK PERS bool cyclicflag1;

PROC main()
  SetupCyclicBool cyclicflag1, dil=1 AND do2=1;
  TPWrite "cyclicflag1 is a cyclic bool: "
          "\Bool:=IsCyclicBool("cyclicflag1");
  ...
```

Using a text string as input to specify the cyclic bool name in **IsCyclicBool** function. The text written to the FlexPendant will be **cyclicflag1 is a cyclic bool: TRUE**.

Example 3

```
..
TPWrite "cyclicflag1 is a cyclic bool: "
        "\Bool:=IsCyclicBool("cyclicflag1", \TaskName:="T_ROB1");
..
```

Using a text string as input to specify the cyclic bool name in **IsCyclicBool** function. The text written to the FlexPendant will be **cyclicflag1 is a cyclic bool: TRUE** if the **cyclicflag1** has been connected to a logical condition with instruction **SetupCyclicBool** in **T_ROB1 RAPID** task, otherwise the text written to the FlexPendant will be **cyclicflag1 is a cyclic bool: FALSE**.

Continues on next page

Return value**Data type:** bool

The function will return `TRUE` if a logical condition has been connected to the persistent boolean with instruction `SetupCyclicBool`, otherwise `FALSE`.

Arguments`IsCyclicBool (Flag | Name [\TaskRef] | [\TaskName])`

Flag

Data type: bool

The persistent boolean variable that should be checked.

Name

Data type: string

The name of the persistent boolean variable that should be checked.

[\TaskRef]

Task Reference**Data type:** taskid

The program task identity where the `SetupCyclicBool` instruction has been executed. This argument should only be used for a Cyclic bool that is declared as `TASK PERS` and when using `IsCyclicBool` function from a `RAPID` task that has not connected the logical condition to the persistent boolean variable with `SetupCyclicBool` instruction.

For all program tasks in the system, predefined variables of the data type `taskid` will be available. The variable identity will be "taskname"+"Id", for example, for the `T_ROB1` task the variable identity will be `T_ROB1Id`.

[\TaskName]

Data type: string

The program task name where the `SetupCyclicBool` instruction has been executed. This argument should only be used for a Cyclic bool that is declared as `TASK PERS` and when using `IsCyclicBool` function from a `RAPID` task that has not connected the logical condition to the persistent boolean variable with `SetupCyclicBool` instruction.

If none of the arguments `\TaskRef` or `\TaskName` are specified then the current task is used.

Program execution

The names of the Cyclic bools are stored in the system as a character string. For a `PERS bool m1` the name stored is `m1`. For a `TASK PERS bool m2` the name will be "`T_ROB1/m2`" if the setup is done with instruction `SetupCyclicBool` in `RAPID` task `T_ROB1`.

If the function is used with argument `Flag` or `Name` it checks first if the persistent name exist in the list of Cyclic bools to see if it is a `PERS` declared variable that has been connected to a condition with `SetupCyclicBool`. If it did not find any

Continues on next page

2 Functions

2.102 IsCyclicBool - Checks if a persistent variable is a Cyclic bool

RobotWare Base

Continued

Cyclic bool with that name, it also test if it is a `TASK PERS` with adding current executing task before the name of the persistent name ("`T_ROB1/name`").

Error handling

The following recoverable errors are generated and can be handled in an error handler. The system variable `ERRNO` will be set to:

Name	Cause of error
<code>ERR_TASKNAME</code>	The program task name in argument <code>\TaskName</code> cannot be found in the system.

Syntax

```
IsCyclicBool '('  
  [ [ Flag ':= ' ] <persistent (PERS) of bool>  
  | [ [ Name ':= ' ] <expression (IN) of string> ', '  
  | '\ ' TaskRef ':= ' <variable (VAR) of taskid>  
  | [ '\ ' TaskName ':= ' <expression (IN) of string> ] )'
```

A function with a return value of the data type `bool`.

Related information

For information about	See
Setup a Cyclic bool condition	SetupCyclicBool - Setup a Cyclic bool condition on page 715
Remove a Cyclic bool condition	RemoveCyclicBool - Remove a Cyclic bool condition on page 600
Remove all Cyclic bool conditions	RemoveAllCyclicBool - Remove all Cyclic bool conditions on page 598
Cyclically evaluated logical conditions, <i>Cyclic bool</i>	<i>Application manual - Controller software IRC5</i>
Configuring <i>Cyclic bool</i>	<i>Technical reference manual - System parameters</i>

2.103 IsFile - Check the type of a file

Usage

The `IsFile` function obtains information about the named file or directory and checks whether it is the same as the specified type. If no type is specified, only an existence check is performed.

The path argument specifies the file. Read, write or execute permission for the named file is not required, but all directories listed in the path name leading to the file must be searchable.

Basic examples

The following example illustrates the function `IsFile`.

See also [More examples on page 1344](#).

Example 1

```
PROC printFT(string filename)
  IF IsFile(filename \Directory) THEN
    TPWrite filename+" is a directory";
    RETURN;
  ENDIF
  IF IsFile(filename \Fifo) THEN
    TPWrite filename+" is a fifo file";
    RETURN;
  ENDIF
  IF IsFile(filename \RegFile) THEN
    TPWrite filename+" is a regular file";
    RETURN;
  ENDIF
  IF IsFile(filename \BlockSpec) THEN
    TPWrite filename+" is a block special file";
    RETURN;
  ENDIF
  IF IsFile(filename \CharSpec) THEN
    TPWrite filename+" is a character special file";
    RETURN;
  ENDIF
ENDPROC
```

This example prints out the `filename` and the type of the specified file on the FlexPendant.

Return value

Data type: `bool`

The function will return `TRUE` if the specified type and actual type match, otherwise `FALSE`. When no type is specified, it returns `TRUE` if the file exists and otherwise `FALSE`.

Continues on next page

2 Functions

2.103 IsFile - Check the type of a file

RobotWare Base

Continued

Arguments

```
IsFile (Path [\Directory] [\Fifo] [\RegFile] [\BlockSpec]
        [\CharSpec])
```

Path

Data type: string

The file specified with a full or relative path.

[\Directory]

Data type: switch

Is the file a directory.

[\Fifo]

Data type: switch

Is the file a fifo file.

[\RegFile]

Data type: switch

Is the file a regular file, that is, a normal binary, ISO 8859-1 (Latin-1) or UTF8 file.

[\BlockSpec]

Data type: switch

Is the file a block special file.

[\CharSpec]

Data type: switch

Is the file a character special file.

Program execution

This function returns a `bool` that specifies match or not.

Error handling

The following recoverable errors are generated and can be handled in an error handler. The system variable `ERRNO` will be set to:

Name	Cause of error
<code>ERR_FILEACC</code>	The file does not exist and there is a type specified.

More examples

More examples of the function `IsFile` are illustrated below.

Example 1

This example implements a generic traverse of a directory structure function.

```
PROC searchdir(string dirname, string actionproc)
  VAR dir directory;
  VAR string filename;
  IF IsFile(dirname \Directory) THEN
    OpenDir directory, dirname;
```

Continues on next page

```
WHILE ReadDir(directory, filename) DO
  ! .. and . is the parent and resp. this directory
  IF filename <> ".." AND filename <> "." THEN
    searchdir dirname+"/"+filename, actionproc;
  ENDIF
ENDWHILE
CloseDir directory;
ELSE
  %actionproc% dirname;
ENDIF
ERROR
RAISE;
ENDPROC

PROC listfile(string filename)
  TPWrite filename;
ENDPROC

PROC main()
  ! Execute the listfile routine for all files found under the
  ! tree of HOME:
  searchdir "HOME:", "listfile";
ENDPROC
```

This program traverses the directory structure under the "HOME:" and for each file found, it calls the `listfile` procedure. The `searchdir` is the generic part that knows nothing about the start of the search or which routine should be called for each file. It uses `IsFile` to check whether it has found a subdirectory or a file and it uses the late binding mechanism to call the procedure specified in `actionproc` for all files found. The `actionproc` routine should be a procedure with one parameter of the type `string`.

Limitations

This function is not possible to use against serial channels or field buses.

If using against FTP or NFS mounted discs, the file existence or type information is not always updated. To get correct information an explicit order may be needed against the search path (with instruction `Open`) before using `IsFile`.

Syntax

```
Isfile '('
  [ Path ':' ] < expression (IN) of string>
  [ '\' Directory ]
  | [ '\' Fifo ]
  | [ '\' RegFile ]
  | [ '\' BlockSpec ]
  | [ '\' CharSpec ] ')''
```

A function with a return value of the data type `bool`.

Continues on next page

2 Functions

2.103 IsFile - Check the type of a file

RobotWare Base

Continued

Related information

For information about	See
Directory	dir - File directory structure on page 1648
Open a directory	OpenDir - Open a directory on page 503
Close a directory	CloseDir - Close a directory on page 152
Read a directory	ReadDir - Read next entry in a directory on page 1426
Make a directory	MakeDir - Create a new directory on page 353
Remove a directory	RemoveDir - Delete a directory on page 602
Rename a file	RenameFile - Rename a file on page 607
Remove a file	RemoveFile - Delete a file on page 604
Copy a file	CopyFile - Copy a file on page 167
Check file size	FileSize - Retrieve the size of a file on page 1274
Check file system size	FSSize - Retrieve the size of a file system on page 1280
File and I/O device handling	Application manual - Controller software IRC5

2.104 IsLeadThrough - Check lead-through status

Usage

`IsLeadThrough` is used to get information about the lead-through status for a TCP robot.

Basic examples

The following examples illustrate the function `IsLeadThrough`.

Example 1

```
VAR bool leadthrough:=FALSE;
leadthrough:=IsLeadThrough();
```

Checks if lead-through is set for the active TCP robot in this task. For example, if executed in RAPID task `T_ROB_L` it checks if lead-through is set for the TCP robot `ROB_L`.

Example 2

```
VAR bool leadthrough:=FALSE;
leadthrough:=IsLeadThrough(\MechUnit:=ROB_R);
```

Checks if lead-through is set for the TCP robot `ROB_R`.

Example 3

```
VAR bool leadthrough:=FALSE;
leadthrough:=IsLeadThrough(\MechUnit:=ROB_R \Active);
```

Checks if lead-through is active for the TCP robot `ROB_R`.

Example 4

```
SetLeadThrough \On \NoStopMove;
TPWrite "Set: "+ValToStr(IsLeadThrough(\MechUnit:=ROB_R \Set));
TPWrite "Active: "+ValToStr(IsLeadThrough(\MechUnit:=ROB_R
\Active));
..
StopMove;
TPWrite "Set: "+ValToStr(IsLeadThrough(\MechUnit:=ROB_R \Set));
TPWrite "Active: "+ValToStr(IsLeadThrough(\MechUnit:=ROB_R
\Active));
```

Checks if lead-through is set and active for the TCP robot `ROB_R`. The lead-through is not active until a `StopMove` instruction has been executed or the program execution has been stopped.

The print out will be:

Set: TRUE

Active: FALSE

Set: TRUE

Active: TRUE

Return value

Data type: `bool`

Continues on next page

2 Functions

2.104 IsLeadThrough - Check lead-through status

YuMi

Continued

Arguments

IsLeadThrough (\MechUnit \Active | \Set)

\MechUnit

Mechanical unit

Data type: mecunit

The name of the TCP robot.

The argument \MechUnit is optional. If it is omitted, the check will be done for the mechanical unit represented by the predefined RAPID variable `ROB_ID`, which is a reference to the TCP robot in the current program task.

If \MechUnit is omitted and IsLeadThrough is used from a non-motion task, the check will be done for the TCP robot in the connected motion task.

\Active

Data type: switch

TRUE if lead-through has been activated.

FALSE if lead-through has been deactivated with SetLeadThrough \Off.

FALSE can also be returned if a SetLeadThrough \On \NoStopMove has been executed. It is the StopMove order, or stop of program execution that activates lead-through.

\Set

Data type: switch

TRUE if lead-through has been set.

FALSE if lead-through has been reset.

If neither of the switches are used, the default behavior is \Set.

Limitations

The mechanical unit has to be a TCP robot.

The function IsLeadThrough can only be used for YuMi robots.

Syntax

```
IsLeadThrough '('  
  ['\MecUnit ':= ' < variable (VAR) of mecunit> ',']  
  ['\Active] | ['\Set]')'
```

A function with a return value of the data type bool.

Related information

For information about	See
Activate and deactivate lead-through	SetLeadThrough - Activate and deactivate lead-through on page 710

2.105 IsMechUnitActive - Is mechanical unit active

Usage

`IsMechUnitActive` (*Is Mechanical Unit Active*) is used to check whether a mechanical unit is activated or not.

Basic examples

The following example illustrates the function `IsMechUnitActive`.

Example 1

```
IF IsMechUnitActive(SpotWeldGun)
  CloseGun SpotWeldGun;
```

If the mechanical unit `SpotWeldGun` is active, the routine `CloseGun` will be invoked in which the gun is closed.

Return value

Data type: `bool`

The function returns:

- `TRUE`, if the mechanical unit is active
- `FALSE`, if the mechanical unit is deactivated

Arguments

```
IsMechUnitActive ( MechUnit )
```

`MechUnit`

Mechanical Unit

Data type: `mecunit`

The name of the mechanical unit.

Syntax

```
IsMechUnitActive '('
  [ MechUnit '[:=' ] < variable (VAR) of mecunit > ')]
```

A function with a return value of the data type `bool`.

Related information

For information about	See
Activating mechanical units	ActUnit - Activates a mechanical unit on page 30
Deactivating mechanical units	DeactUnit - Deactivates a mechanical unit on page 184
Mechanical units	mecunit - Mechanical unit on page 1690

2 Functions

2.106 IsPers - Is persistent *RobotWare Base*

2.106 IsPers - Is persistent

Usage

`IsPers` is used to test if a data object is a persistent variable or not.

Basic examples

The following example illustrates the function `IsPers`.

Example 1

```
PROC procedure1 (INOUT num parameter1)
  IF IsVar(parameter1) THEN
    ! For this call reference to a variable
    ...
  ELSEIF IsPers(parameter1) THEN
    ! For this call reference to a persistent variable
    ...
  ELSE
    ! Should not happen
    EXIT;
  ENDF
ENDPROC
```

The procedure `procedure1` will take different actions depending on whether the actual parameter `parameter1` is a variable or a persistent variable.

Return value

Data type: `bool`

TRUE if the tested actual `INOUT` parameter is a persistent variable. FALSE if the tested actual `INOUT` parameter is not a persistent variable.

Arguments

`IsPers (DatObj)`

`DatObj`

Data Object

Data type: `anytype`

The name of the formal `INOUT` parameter.

Syntax

```
IsPers '('
  [ DatObj ':=' ] < var or pers (INOUT) of anytype > ')'
```

A function with a return value of the data type `bool`.

Related information

For information about	See
Test if variable	IsVar - Is variable on page 1358
Types of parameters (access modes)	<i>Technical reference manual - RAPID Overview, section Basic characteristics - Routines</i>

2.107 IsStopMoveAct - Is stop move flags active

Usage

`IsStopMoveAct` is used to get the status of the stop move flags for a current or connected motion task.

Basic examples

The following examples illustrate the function `IsStopMoveAct`.

Example 1

```
stopflag2:= IsStopMoveAct(\FromNonMoveTask);
```

`stopflag2` will be TRUE if the stop move flag from non-motion tasks is set in current or connected motion task, else it will be FALSE.

Example 2

```
IF IsStopMoveAct(\FromMoveTask) THEN
  StartMove;
ENDIF
```

If the stop move flag from motion task is set in the current motion task, it will be reset by the `StartMove` instruction.

Return value

Data type: `bool`

The return value will be TRUE if the selected stop move flag is set, else the return value will be FALSE.

Arguments

```
IsStopMoveAct ( [\FromMoveTask] | [\FromNonMoveTask] )
```

`[\FromMoveTask]`

Data type: `switch`

`FromMoveTask` is used to get the status of the stop move flag of type private motion task.

This type of stop move flag can only be set by:

- The motion task itself with instruction `StopMove`
- After leaving the `RestoPath` level in the program
- At execution in an asynchronous error handler for process- or motion errors before any `StorePath` and after any `RestoPath`

`[\FromNonMoveTask]`

Data type: `switch`

`FromNonMoveTask` is used to get the status of the stop move flag of type any non-motion tasks. This type of stop move flag can only be set by any non-motion task in connected or all motion tasks with the instruction `StopMove`.

Continues on next page

2 Functions

2.107 IsStopMoveAct - Is stop move flags active

RobotWare Base

Continued

Syntax

```
IsStopMoveAct '('  
    ['\' FromMoveTask]  
    | ['\' FromNonMoveTask] ')'
```

A function with a return value of the data type `bool`.

Related information

For information about	See
Stop robot movement	StopMove - Stops robot movement on page 820
Restart robot movement	StartMove - Restarts robot movement on page 791

2.108 IsStopStateEvent - Test whether moved program pointer

Usage

IsStopStateEvent returns information about the movement of the Program Pointer (PP) in current program task.

Basic examples

The following example illustrates the function IsStopStateEvent.

Example 1

```
IF IsStopStateEvent (\PPMoved) = TRUE THEN
  ! PP has been moved during the last program stop
ELSE
  ! PP has not been moved during the last program stop
ENDIF

IF IsStopStateEvent (\PPToMain) THEN
  ! PP has been moved to main routine during the last program stop
ENDIF
```

Return value

Data type: bool

Status if and how PP has been moved during the last stop state.

TRUE if PP has been moved during the last stop.

FALSE if PP has not been moved during the last stop.

If PP has been moved to the main routine, both \PPMoved and \PPToMain will return TRUE.

If PP has been moved to a routine, both \PPMoved and \PPToMain will return TRUE.

If PP has been moved within a list of a routine, \PPMoved will return TRUE and \PPToMain will return FALSE.

After calling a service routine (keep execution context in main program sequence) \PPMove will return FALSE and \PPToMain will return FALSE.

Arguments

IsStopStateEvent ([\PPMoved] | [\PPToMain])

[\PPMoved]

Data type: switch

Test whether PP has been moved.

[\PPToMain]

Data type: switch

Test whether PP has been moved to main or to a routine.

Continues on next page

2 Functions

2.108 IsStopStateEvent - Test whether moved program pointer

RobotWare Base

Continued

Limitations

This function in most cases cannot be used during forward or backward execution because the system is in stop state between every single step.

Syntax

```
IsStopStateEvent '('  
    ['\' PPMoved] | ['\' PPToMain] ')'
```

A function with a return value of the data type `bool`.

Related information

For information about	See
Making own instructions	<i>Technical reference manual - RAPID Overview</i>
<i>Advanced RAPID</i>	<i>Product specification - Controller software IRC5</i>

2.109 IsSyncMoveOn - Test if in synchronized movement mode

Usage

IsSyncMoveOn is used to test if the current program task of type `Motion Task` is in synchronized movement mode or not.

It is also possible from some `Non Motion Task` to test if the connected `Motion Task` is in synchronized movement mode or not. The system parameter *Controller/Tasks/Use Mechanical Unit Group* define the connected `Motion Task`.

When the `Motion Task` is executing at `StorePath` level IsSyncMoveOn will test if the task is in synchronized mode on that level, independently of the synchronized mode on the original level.

The instruction IsSyncMoveOn is usually used in a *MultiMove* system with option *Coordinated Robots* but can be used in any system and in any program task.

Basic examples

The following example illustrates the function IsSyncMoveOn.

Example 1

Program example in task T_ROB1

```
PERS tasks task_list{2} := [ ["T_ROB1"], ["T_ROB2"] ];
VAR syncident sync1;
VAR syncident sync2;
VAR syncident sync3;
```

```
PROC main()
...
MoveL p_zone, vmax, z50, tcp1;
WaitSyncTask sync1, task_list;
MoveL p_fine, v1000, fine, tcp1;
syncmove;
...
ENDPROC
```

```
PROC syncmove()
SyncMoveOn sync2, task_list;
MoveL * \ID:=10, v100, z10, tcp1 \WOBJ:= rob2_obj;
MoveL * \ID:=20, v100, fine, tcp1 \WOBJ:= rob2_obj;
SyncMoveOff sync3;
UNDO
SyncMoveUndo;
ENDPROC
```

Program example in task BCK1

```
PROC main()
...
IF IsSyncMoveOn() THEN
! Connected Motion Task is in synchronized movement mode
ELSE
! Connected Motion Task is in independent mode
```

Continues on next page

2 Functions

2.109 IsSyncMoveOn - Test if in synchronized movement mode

RobotWare Base

Continued

```
ENDIF
...
ENDPROC
```

At the execution time of `IsSyncMoveOn`, in the background task `BCK1`, we test if the connected motion task at that moment is in synchronized movement mode or not.

Return value

Data type: `bool`

`TRUE` if current or connected program task is in synchronized movement mode at the moment, otherwise `FALSE`.

Program execution

Test if current or connected program task is in synchronized movement mode at the moment or not. If the `MotionTask` is executing at `StorePath` level, the `SyncMoveOn` will test if the task is in synchronized movement on the `StorePath` level, not on the original level.

Syntax

```
IsSyncMoveOn '(' ' ')
```

A function with a return value of the data type `bool`.

Related information

For information about	See
Specify cooperated program tasks	tasks - RAPID program tasks on page 1772
Identity for synchronization point	syncident - Identity for synchronization point on page 1768
Start coordinated synchronized movements	SyncMoveOn - Start coordinated synchronized movements on page 842
End coordinated synchronized movements	SyncMoveOff - End coordinated synchronized movements on page 836
Set independent movements	SyncMoveUndo - Set independent movements on page 852
Store path and execute on new level	StorePath - Stores the path when an interrupt occurs on page 826

2.110 IsSysId - Test system identity

Usage

IsSysId (*System Identity*) can be used to test the system identity using the system serial number.

Basic examples

The following example illustrates the function IsSysId.

Example 1

```
IF NOT IsSysId("6400-1234") THEN
  ErrWrite "System identity fault", "Faulty system identity for
  this program";
  EXIT;
ENDIF
```

The program is made for a special robot system with serial number 6400-1234 and cannot be used by another robot system.

Return value

Data type: bool

TRUE = The robot system serial number is the same as specified in the test.

FALSE = The robot system serial number is not the same as specified in the test.

Arguments

IsSysId (SystemId)

SystemId

Data type: string

The robot system serial number, marking the system identity.

Syntax

```
IsSysId '('
  [ SystemId ':= ' ] < expression (IN) of string> ')'
```

A function with a return value of the data type bool.

Related information

For information about	See
Read system information	GetSysInfo - Get information about the system on page 1306

2 Functions

2.111 IsVar - Is variable

RobotWare Base

2.111 IsVar - Is variable

Usage

`IsVar` is used to test whether a data object is a variable or not.

Basic examples

The following example illustrates the function `IsVar`.

Example 1

```
PROC procedure1 (INOUT num parameter1)
  IF IsVAR(parameter1) THEN
    ! For this call reference to a variable
    ...
  ELSEIF IsPers(parameter1) THEN
    ! For this call reference to a persistent variable
    ...
  ELSE
    ! Should not happen
    EXIT;
  ENDIF
ENDPROC
```

The procedure `procedure1` will take different actions, depending on whether the actual parameter `parameter1` is a variable or a persistent variable.

Return value

Data type: `bool`

TRUE if the tested actual INOUT parameter is a variable. FALSE if the tested actual INOUT parameter is not a variable.

Arguments

`IsVar (DatObj)`

`DatObj`

Data Object

Data type: `anytype`

The name of the formal INOUT parameter.

Syntax

```
IsVar '('
  [ DatObj ':=' ] < var or pers (INOUT) of anytype > ')'
```

A function with a return value of the data type `bool`.

Related information

For information about	See
Test if persistent	IsPers - Is persistent on page 1350
Types of parameters (access modes)	<i>Technical reference manual - RAPID Overview, section Basic characteristics - Routines</i>

2.112 Max - Get the largest of two values

Usage

Max returns the largest of two arguments.

Basic examples

The following example illustrates the function Max.

Example 1

```
reg1 := Max(reg2, reg3)
```

reg1 is assigned the largest value of reg2 and reg3.

Return value

Data type: num

Returns the largest of the two arguments.

Arguments

Max (A, B)

A

Data type: num

First numeric value.

B

Data type: num

Second numeric value.

Syntax

```
Max '('  
  [A ':=' ] < expression (IN) of num > ','  
  [B ':=' ] < expression (IN) of num > ')'
```

A function with a return value of the data type num.

Related information

For information about	See
Min function	Min - Get the smallest of two values on page 1364
Mathematical instructions and functions	<i>Technical reference manual - RAPID Overview</i>

2 Functions

2.113 MaxExtLinearSpeed - Maximum additional axis speed

RobotWare Base

2.113 MaxExtLinearSpeed - Maximum additional axis speed

Usage

`MaxExtLinearSpeed` (Maximum Additional Axis Linear Speed) returns the maximum linear speed for the additional axes in the current motion task.

Basic examples

The following example illustrates the function `MaxExtLinearSpeed`.

Example 1

```
TPWrite "Max. Linear speed in mm/s for my axis="\Num:=  
MaxExtLinearSpeed ();
```

The message `Max. Linear speed in mm/s for my axis = 5000` is written on the FlexPendant (value depends on the configuration).

Return value

Data type: `num`

Returns the maximum (v_{max}) linear speed in mm/s for the additional axes in this task.

Syntax

```
MaxExtLinearSpeed '(' '')
```

A function with a return value of the data type `num`.

Related information

For information about	See
Definition of v_{max} velocity	speeddata - Speed data on page 1751
Configuring max additional axis linear speed	<i>Technical reference manual - System parameters, parameter Ext. Axis Linear Max Speed (m/s)</i>

2.114 MaxExtReorientSpeed - Maximum additional axis rotational speed

RobotWare Base

2.114 MaxExtReorientSpeed - Maximum additional axis rotational speed

Usage

MaxExtReorientSpeed (Maximum Additional Axis Rotational Speed) returns the maximum rotational speed for the additional axes in the current motion task.

Basic examples

The following example illustrates the function MaxExtReorientSpeed.

Example 1

```
TPWrite "Max. Rotational speed in deg/s for my axis="\Num:=
MaxExtReorientSpeed ();
```

The message Max. Rotational speed in deg/s for my axis = 1000 is written on the FlexPendant (value depends on the configuration).

Return value

Data type: num

Returns the maximum (v_{max}) rotational speed in deg/s for the additional axes in this task.

Syntax

```
MaxExtReorientSpeed '(' ' ')
```

A function with a return value of the data type num.

Related information

For information about	See
Definition of v_{max} velocity	speeddata - Speed data on page 1751
Configuring max additional axis rotational speed	<i>Technical reference manual - System parameters, parameter Ext. Axis Rotational Max Speed (deg/s)</i>

2 Functions

2.115 MaxRobReorientSpeed - Maximum reorient speed of robot
RobotWare Base

2.115 MaxRobReorientSpeed - Maximum reorient speed of robot

Usage

MaxRobReorientSpeed (Maximum Robot Reorient Speed) returns the maximum TCP reorient speed for the robot.

Basic examples

The following example illustrates the function MaxRobReorientSpeed.

Example 1

```
TPWrite "TCP Reorient Max Speed in deg/s for my robot="\Num:=  
MaxRobReorientSpeed ();
```

The message TCP Reorient Max Speed in deg/s for my robot = 500 is written on the FlexPendant (value depends on the configuration).

Return value

Data type: num

Returns the maximum (v_{max}) TCP reorient speed in deg/s for the used robot and normal practical TCP values.

If extremely large TCP values are used in the tool frame, you can create your own speeddata with lower TCP reorient speed than returned by MaxRobReorientSpeed.

Syntax

```
MaxRobReorientSpeed '(' ' ')
```

A function with a return value of the data type num.

Related information

For information about	See
Definition of v_{max} velocity	speeddata - Speed data on page 1751
Configuring max TCP reorientation speed	<i>Technical reference manual - System parameters, parameter TCP Reorient Max Speed (deg/s)</i>

2.116 MaxRobSpeed - Maximum robot speed

Usage

MaxRobSpeed (*Maximum Robot Speed*) returns the maximum TCP speed for the robot.

Basic examples

The following example illustrates the function MaxRobSpeed.

Example 1

```
TPWrite "Max. TCP speed in mm/s for my robot="\Num:=MaxRobSpeed();
```

The message Max. TCP speed in mm/s for my robot = 7000 is written on the FlexPendant (value depends on the configuration).

Return value

Data type: num

Returns the maximum (v_{max}) TCP speed in mm/s for the used robot and normal practical TCP values.

If extremely large TCP values are used in the tool frame, you can create your own speeddata with bigger TCP speed than returned by MaxRobSpeed and use VelSet to allow larger speed.

Syntax

```
MaxRobSpeed '(' ' ')
```

A function with a return value of the data type num.

Related information

For information about	See
Definition of v_{max} velocity	speeddata - Speed data on page 1751
Definition of maximum velocity	VelSet - Changes the programmed velocity on page 1017
Configuring max TCP speed	<i>Technical reference manual - System parameters, parameter TCP Linear Max Speed (m/s)</i>

2 Functions

2.117 Min - Get the smallest of two values

RobotWare Base

2.117 Min - Get the smallest of two values

Usage

Min returns the smallest of two arguments.

Basic examples

The following example illustrates the function Min.

Example 1

```
reg1 := Min(reg2, reg3)
```

reg1 is assigned the smallest value of reg2 and reg3.

Return value

Data type: num

Returns the smallest of the two arguments.

Arguments

Min (A, B)

A

Data type: num

First numeric value.

B

Data type: num

Second numeric value.

Syntax

```
Min '('  
  [A ':=' ] < expression (IN) of num > ','  
  [B ':=' ] < expression (IN) of num > ')'
```

A function with a return value of the data type num.

Related information

For information about	See
Max function	Max - Get the largest of two values on page 1359
Mathematical instructions and functions	<i>Technical reference manual - RAPID Overview</i>

2.118 MirPos - Mirroring of a position

Usage

`MirPos` (*Mirror Position*) is used to mirror the translation and rotation parts of a position.

Basic examples

The following example illustrates the function `MirPos`.

Example 1

```
CONST robtarget p1:= [...];
VAR robtarget p2;
PERS wobjdata mirror:= [...];
...
p2 := MirPos(p1, mirror);
```

`p1` is a `robtarget` storing a position of the robot and an orientation of the tool. This position is mirrored in the xy-plane of the frame defined by `mirror`, relative to the world coordinate system. The result is new `robtarget` data, which is stored in `p2`.

Return value

Data type: `robtarget`

The new position which is the mirrored position of the input position.

Arguments

```
MirPos (Point MirPlane [\WObj] [\MirY])
```

Point

Data type: `robtarget`

The input robot position. The orientation part of this position defines the current orientation of the tool coordinate system.

MirPlane

Mirror Plane

Data type: `wobjdata`

The work object data defining the mirror plane. The mirror plane is the xy-plane of the object frame defined in `MirPlane`. The location of the object frame is defined relative to the user frame (also defined in `MirPlane`) which in turn is defined relative to the world frame.

[\WObj]

Work Object

Data type: `wobjdata`

The work object data defining the object frame and user frame relative to which the input position *Point* is defined. If this argument is left out the position is defined relative to the World coordinate system.

NOTE!

Continues on next page

2 Functions

2.118 MirPos - Mirroring of a position

RobotWare Base

Continued

If the position is created with an active work object, this work object must be referred to in the argument.

[\MirY]

Mirror Y

Data type: switch

If this switch is left out, which is the default behavior, the tool frame will be mirrored with regards to the x-axis and the z-axis. If the switch is specified the tool frame will be mirrored with regards to the y-axis and the z-axis.

Limitations

No recalculation is done of the robot configuration part of the input robtargt data. If a coordinate frame is used, the coordinated unit has to be situated in the same task as the robot.

Syntax

```
MirPos '('  
  [ Point ':=' ] < expression (IN) of robtargt > ','  
  [ MirPlane ':=' ] <expression (IN) of wobjdata> ','  
  [ '\ ' WObj ':=' <expression (IN) of wobjdata> ]  
  [ '\ ' MirY ] ')'
```

A function with a return value of the data type robtargt.

Related information

For information about	See
Mathematical instructions and functions	<i>Technical reference manual - RAPID Overview, section RAPID Summary - Mathematics</i>
Position data	robtargt - Position data on page 1734
Work object data	wobjdata - Work object data on page 1803

2.119 MOD - Evaluates an integer modulo

Usage

MOD is a conditional expression used to evaluate the modulo, the remainder, of a division of integers.

Basic examples

The following examples illustrate the function MOD.

Example 1

```
reg1 := 14 MOD 4;
```

The return value is 2 because 14 divided by 4 gives the modulo 2.

Example 2

```
VAR dnum mydnum1 := 11;
VAR dnum mydnum2 := 5;
VAR dnum mydnum3;
...
mydnum3 := mydnum1 MOD mydnum2;
```

The return value is 1 because 11 divided by 5 gives the modulo 1.

Return value

Data type: num, dnum

Returns the modulo, the remainder, of a division of integers.

Syntax

```
<expression of num> MOD <expression of num>
```

A function with a return value of data type num.

```
<expression of dnum> MOD <expression of dnum>
```

A function with a return value of data type dnum.

Related information

For information about	See
num - Numeric values	num - Numeric values on page 1698
dnum - Double numeric values	dnum - Double numeric values on page 1649
DIV	DIV - Evaluates an integer division on page 1258
Expressions	Technical reference manual - RAPID Overview

2 Functions

2.120 ModExist - Check if program module exist

RobotWare Base

2.120 ModExist - Check if program module exist

Usage

`ModExist` (*Module Exist*) is used to check whether a given module exists or not in the program task.

Searching is first done for loaded modules and afterward, if none is found, for installed modules.

Basic examples

The following example illustrates the function `ModExist`.

Example 1

```
VAR bool mod_exist;  
mod_exist:=ModExist ("MyModule");
```

If module `MyModule` exists within the task, the function will return `TRUE`. If not, the function will return `FALSE`.

Return value

Data type: `bool`

`TRUE` if the module was found, `FALSE` if not.

Arguments

```
ModExist (ModuleName)
```

ModuleName

Data type: `string`

Name of the module to search for.

Syntax

```
ModExist '('  
  [ ModuleName ':' ] < expression (IN) of string > ')'
```

A function with a return value of the data type `bool`.

Related information

For information about	See
Find modify time for loaded module	ModTimeDnum - Get file modify time for the loaded module on page 1369

2.121 ModTimeDnum - Get file modify time for the loaded module

Usage

`ModTimeDnum` (*Modify Time*) is used to retrieve the last file modification time for the loaded module. The module is specified by its name and must be in the task memory. The time is measured in seconds since 00:00:00 GMT, Jan. 1 1970. The time is returned as a `dnum` and optionally also as a `stringdig`.

Basic examples

The following example illustrates the function `ModTimeDnum`.

See also [More examples on page 1370](#).

Example 1

```
MODULE mymod
  VAR dnum mytime;
  PROC printMyTime()
    mytime := ModTimeDnum("mymod");
    TPWrite "My time is "+ValToStr(mytime);
  ENDPROC
ENDMODULE
```

Return value

Data type: `dnum`

The time measured in seconds since 00:00:00 GMT, Jan. 1 1970.

Arguments

```
ModTimeDnum ( Object [\StrDig] )
```

Object

Data type: `string`

The name of the module.

[\StrDig]

String Digit

Data type: `stringdig`

To get the mod loading time in a `stringdig` representation.

Program execution

This function returns a numeric value that specifies the last time a file was modified before it was loaded as a program module in the system.

Error handling

The following recoverable errors are generated and can be handled in an error handler. The system variable `ERRNO` will be set to:

Name	Cause of error
<code>ERR_MOD_NOT_LOADED</code>	No module with specified name is in the program task.

Continues on next page

2 Functions

2.121 ModTimeDnum - Get file modify time for the loaded module

RobotWare Base

Continued

More examples

More examples of the function `ModTimeDnum` are illustrated below.

Example 1

```
IF FileTimeDnum ("HOME:/mymod.mod" \ModifyTime) > ModTimeDnum
  ("mymod") THEN
  UnLoad "HOME:/mymod.mod";
  Load \Dynamic, "HOME:/mymod.mod";
ENDIF
```

This program reloads a module if the source file is newer. It uses the `ModTimeDnum` to retrieve the latest modify time for the specified module, and compares it to the `FileTimeDnum ("HOME:/mymod.mod" \ModifyTime)` at the source. Then, if the source is newer, the program unloads and loads the module again.

Limitations

This function will always return 0 if used on a module that is encoded or installed shared.

Syntax

```
ModTimeDnum '('
  [Object ':='] <expression (IN) of string>
  ['\' StrDig ':='] <variable (VAR) of stringdig>]')'
```

A function with a return value of the data type `dnum`.

Related information

For information about	See
Retrieve time information about a file	FileTimeDnum - Retrieve time information about a file on page 1277
String with only digits	stringdig - String with only digits on page 1763
Compare two strings with only digits	StrDigCmp - Compare two strings with only digits on page 1483

2.122 MotionPlannerNo - Get connected motion planner number

Usage

`MotionPlannerNo` returns the connected motion planner number. If executing `MotionPlannerNo` in a motion task, it returns its planner number. Else if executing `MotionPlannerNo` in a non-motion task it returns the connected motion planner number according to the setup in the system parameters.

Basic examples

The following example illustrates the function `MotionPlannerNo`.

Example 1

```

!Motion task T_ROB1
PERS string buffer{6} := ["", "", "", "", "", ""];
VAR num motion_planner;

PROC main()
  ...
  MoveL point, v1000, fine, tcp1;
  motion_planner := MotionPlannerNo();
  buffer{motion_planner} := "READY";
  ...
ENDPROC

!Background task BCK1
PERS string buffer{6};
VAR num motion_planner;
VAR string status;

PROC main()
  ...
  motion_planner := MotionPlannerNo();
  status := buffer{motion_planner};
  ...
ENDPROC

!Motion T_ROB2
PERS string buffer{6};
VAR num motion_planner;

PROC main()
  ...
  MoveL point, v1000, fine, tcp1;
  motion_planner := MotionPlannerNo();
  buffer{motion_planner} := "READY";
  ...
ENDPROC

!Background task BCK2
PERS string buffer{6};

```

Continues on next page

2 Functions

2.122 MotionPlannerNo - Get connected motion planner number

RobotWare Base

Continued

```
VAR num motion_planner;  
VAR string status;  
  
PROC main()  
  ...  
  motion_planner := MotionPlannerNo();  
  status := buffer{motion_planner};  
  ...  
ENDPROC
```

Use the function `MotionPlannerNo` to find out which motion planner number is connected to the task. The exact same code can be implemented in all motion tasks and background tasks. Then each background task can check the status for their connected motion task.

Return value

Data type: num

The number of the connected motion planner. For non-motion tasks, the motion planner number of the associated mechanical unit will be returned.

The return value range is 1 ... 6.

Syntax

```
MotionPlannerNo '(' '')
```

A function with a return value of the data type `num`.

Related information

For information about	See
Specify cooperated program tasks	<i>Technical reference manual - System parameters, section Controller - Task</i>

2.123 NonMotionMode - Read the Non-Motion execution mode

Usage

`NonMotionMode` (*Non-Motion Execution Mode*) is used to read the current Non-Motion execution mode of the program task. Non-motion execution mode is selected or removed from the FlexPendant under the menu *ABB\Control Panel\Supervision*.

Basic examples

The following example illustrates the function `NonMotionMode`.

Example 1

```
IF NonMotionMode() =TRUE THEN
    ...
ENDIF
```

The program section is executed only if the robot is in Non-Motion execution mode.

Return value

Data type: `bool`

The current Non-motion mode as defined in the table below.

Return value	Symbolic constant	Comment
0	FALSE	Non-Motion execution is not used
1	TRUE	Non-Motion execution is used

Arguments

```
NonMotionMode ( [ \Main ] )
```

[\Main]

Data type: `switch`

Return current running mode for connected motion task. Used in a multi-tasking system to get the current running mode for the actual task, if it is a motion task or connected motion task, if function `NonMotionMode` is executed in a nonmotion task.

If this argument is omitted, the return value always mirrors the current running mode for the program task that executes the function `NonMotionMode`.

Note that the execution mode is connected to the system and not any task. This means that all tasks in a system will give the same return value from `NonMotionMode`.

Syntax

```
NonMotionMode '(' [ '\ Main ] ''
```

A function with a return value of the data type `bool`.

Continues on next page

2 Functions

2.123 NonMotionMode - Read the Non-Motion execution mode

RobotWare Base

Continued

Related information

For information about	See
Reading operating mode	OpMode - Read the operating mode on page 1383

2.124 NOT - Inverts a logical value

Usage

NOT is a conditional expression used to invert a logical value (true/false).

Basic examples

The following examples illustrate the conditional expression NOT.

Example 1

```
VAR bool mybool;
mybool := NOT mybool;
```

If mybool is TRUE, the return value is FALSE.

If mybool is FALSE, the return value is TRUE.

Example 2

```
VAR bool a;
VAR bool b;
VAR bool c;
...
c := a AND (NOT b);
```

The return value c is TRUE if a is TRUE and b is FALSE

Return value

Data type: bool

Returns the inverted value.

Syntax

```
NOT <logical term>
```

Related information

For information about	See
AND	AND - Evaluates a logical value on page 1151
OR	OR - Evaluates a logical value on page 1384
XOR	XOR - Evaluates a logical value on page 1596
Expressions	<i>Technical reference manual - RAPID Overview</i>

2 Functions

2.125 NOrient - Normalize orientation

RobotWare Base

2.125 NOrient - Normalize orientation

Usage

NOrient (*Normalize Orientation*) is used to normalize un-normalized orientation (quaternion).

Description

An orientation must be normalized, that is, the sum of the squares must equal 1:

$$q_1^2 + q_2^2 + q_3^2 + q_4^2 = 1$$

xx0500002452

If the orientation is slightly un-normalized, it is possible to normalize it. The normalization error is the absolute value of the sum of the squares of the orientation components. The orientation is considered to be slightly un-normalized if the normalization error is greater than 0.00001 and less than 0.1. If the normalization error is greater than 0.1 the orient is unusable.

$$\text{ABS}(\sqrt{q_1^2 + q_2^2 + q_3^2 + q_4^2} - 1) = \text{normerr}$$

xx0500002453

normerr > 0.1 Unusable

normerr > 0.00001 AND normerr <= 0.1 Slightly un-normalized

normerr <= 0.00001 Normalized

Basic examples

The following example illustrates the function NOrient.

Example 1

We have a slightly un-normalized position (0.707170, 0, 0, 0.707170)

$$\text{ABS}(\sqrt{0.707170^2 + 0^2 + 0^2 + 0.707170^2} - 1) = 0.0000894$$

0,0000894 > 0,00001 ⇒ unnormalized

xx0500002451

```
VAR orient unnormorient := [0.707170, 0, 0, 0.707170];
VAR orient normorient;
...
...
normorient := NOrient(unnormorient);
```

The normalization of the orientation (0.707170, 0, 0, 0.707170) becomes (0.707107, 0, 0, 0.707107).

Return value

Data type: orient

The normalized orientation.

Continues on next page

Arguments

NOrient (Rotation)

Rotation**Data type:** orient

The orientation to be normalized.

Error handling

The following recoverable errors are generated and can be handled in an error handler. The system variable `ERRNO` will be set to:

Name	Cause of error
ERR_ORIENT_VALUE	Wrong orientation value in NOrient function.

Syntax

```
NOrient '('
  [Rotation ':=' ] <expression (IN) of orient> ')'
```

A function with a return value of the data type orient.

Related information

For information about	See
Mathematical instructions and functions	<i>Technical reference manual - RAPID Overview, section RAPID summary - Mathematics</i>

2 Functions

2.126 NumToDnum - Converts num to dnum

RobotWare Base

2.126 NumToDnum - Converts num to dnum

Usage

NumToDnum converts a num to a dnum.

Basic examples

The following example illustrates the function NumToDnum.

Example 1

```
VAR num mynum:=55;  
VAR dnum mydnum:=0;  
mydnum:=NumToDnum(mynum);
```

The num value 55 is returned by the function as the dnum value 55.

Return value

Data type: dnum

The return value of type dnum will have the same value as the input value of type num.

Arguments

NumToDnum (Value)

Value

Data type: num

The numeric value to be converted.

Syntax

```
NumToDnum '('  
  [ Value ':' '=' ] < expression (IN) of num > ')'
```

A function with a return value of the data type dnum.

Related information

For information about	See
Num data type	num - Numeric values on page 1698
Dnum data type	dnum - Double numeric values on page 1649

2.127 NumToStr - Converts numeric value to string

Usage

NumToStr (*Numeric To String*) is used to convert a numeric value to a string.

Basic examples

The following examples illustrate the function NumToStr.

Example 1

```
VAR string str;
str := NumToStr(0.38521,3);
```

The variable `str` is given the value "0.385".

Example 2

```
reg1 := 0.38521;
str := NumToStr(reg1, 2\Exp);
```

The variable `str` is given the value "3.85E-01".

Example 3

```
reg1 := 0.38521;
str := NumToStr(reg1, 2\Compact);
```

The variable `str` is given the value "0.39".

Return value

Data type: string

The numeric value converted to a string with the specified number of decimals, with exponent if so requested. The numeric value is rounded if necessary. The decimal point is suppressed if no decimals are included.

Arguments

```
NumToStr (Val Dec [\Exp] | [\Compact])
```

Val

Value

Data type: num

The numeric value to be converted.

Dec

Decimals

Data type: num

Number of decimals or significant figures for Compact.

[\Exp]

Exponent

Data type: switch

To use exponent in return value.

Continues on next page

2 Functions

2.127 NumToStr - Converts numeric value to string

RobotWare Base

Continued

[\Compact]

Compact

Data type: switch

To be used to get a short format in the return value.

Syntax

```
NumToStr '('  
  [ Val ':=' ] <expression (IN) of num>  
  [ Dec ':=' ] <expression (IN) of num>  
  ['\ Exp ] | ['\ Compact ]')'
```

A function with a return value of the data type string.

Related information

For information about	See
String functions	<i>Technical reference manual - RAPID Overview, section RAPID summary - String functions</i>
Definition of string	string - Strings on page 1761
String values	<i>Technical reference manual - RAPID Overview, section Basic characteristics - Basic elements</i>
Convert a dnum numeric value to a string	DnumToStr - Converts numeric value to string on page 1261

2.128 Offs - Displaces a robot position

Usage

`Offs` is used to add an offset in the object coordinate system to a robot position.

Basic examples

The following examples illustrate the function `Offs`.

See also [More examples on page 1381](#).

Example 1

```
MoveL Offs(p2, 0, 0, 10), v1000, z50, tool1;
```

The robot is moved to a point 10 mm from the position `p2` (in the z-direction).

Example 2

```
p1 := Offs (p1, 5, 10, 15);
```

The robot position `p1` is displaced 5 mm in the x-direction, 10 mm in the y-direction and 15 mm in the z-direction.

Return value

Data type: `robtarget`

The displaced position data.

Arguments

```
Offs (Point XOffset YOffset ZOffset)
```

Point

Data type: `robtarget`

The position data to be displaced.

XOffset

Data type: `num`

The displacement in the x-direction, in the object coordinate system.

YOffset

Data type: `num`

The displacement in the y-direction, in the object coordinate system.

ZOffset

Data type: `num`

The displacement in the z-direction, in the object coordinate system.

More examples

More examples of the function `Offs` are illustrated below.

Example 1

```
PROC pallet (num row, num column, num distance, PERS tooldata tool,
            PERS wobjdata wobj)
VAR robtarget palletpos:=[[0, 0, 0], [1, 0, 0, 0], [0, 0, 0, 0],
                        [9E9, 9E9, 9E9, 9E9, 9E9, 9E9]];

```

Continues on next page

2 Functions

2.128 Offs - Displaces a robot position

RobotWare Base

Continued

```
palettpos := Offs (palettpos, (row-1)*distance, (column-1)*distance,
0);
MoveL palettpos, v100, fine, tool\WObj:=wobj;
ENDPROC
```

A routine for picking parts from a pallet is made. Each pallet is defined as a work object (see figure below). The part to be picked (row and column) and the distance between the parts are given as input parameters. Incrementing the row and column index is performed outside the routine.

The figure shows the position and orientation of the pallet is specified by defining a work object.

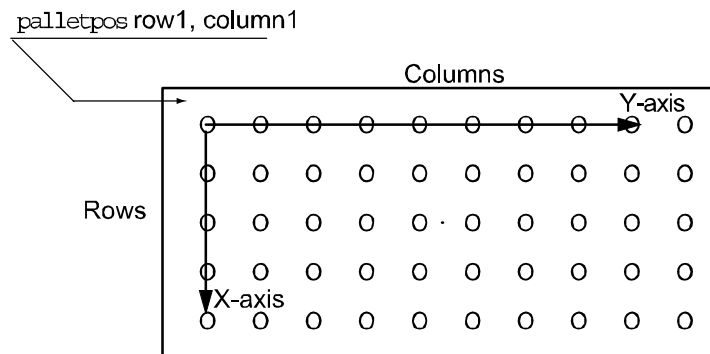

xx050002300_

Syntax

```
Offs '('
  [Point ':='] <expression (IN) of robtarget> ', '
  [XOffset ':='] <expression (IN) of num> ', '
  [YOffset ':='] <expression (IN) of num> ', '
  [ZOffset ':='] <expression (IN) of num> ')'
```

A function with a return value of the data type `robtarget`.

Related information

For information about	See
Position data	robtarget - Position data on page 1734
Mathematical instructions and functions	<i>Technical reference manual - RAPID Overview, section RAPID Summary - Mathematics</i>
Positioning instructions	<i>Technical reference manual - RAPID Overview, section RAPID summary - Motion</i>

2.129 OpMode - Read the operating mode

Usage

`OpMode(Operating Mode)` is used to read the current operating mode of the system.

Basic examples

The following example illustrates the function `OpMode`.

Example 1

```

TEST OpMode()
CASE OP_AUTO:
    ...
CASE OP_MAN_PROG:
    ...
CASE OP_MAN_TEST:
    ...
DEFAULT:
    ...
ENDTEST

```

Different program sections are executed depending on the current operating mode.

Return value

Data type: `symnum`

The current operating mode as defined in the table below.

Return value	Symbolic constant	Comment
0	OP_UNDEF	Undefined operating mode
1	OP_AUTO	Automatic operating mode
2	OP_MAN_PROG	Manual operating mode max. 250 mm/s
3	OP_MAN_TEST	Manual operating mode full speed, 100 %

Syntax

```
OpMode '( ' )'
```

A function with a return value of the data type `symnum`.

Related information

For information about	See
Different operating modes	<i>Operating manual - IRC5 with FlexPendant</i>
Reading running mode	RunMode - Read the running mode on page 1454

2 Functions

2.130 OR - Evaluates a logical value

RobotWare Base

2.130 OR - Evaluates a logical value

Usage

OR is a conditional expression used to evaluate a logical value (true/false).

Basic examples

The following examples illustrate the function OR.

Example 1

```
VAR num a;  
VAR num b;  
VAR bool c;  
...  
c := a>5 OR b=3;
```

The return value of `c` is **TRUE** if `a` is larger than 5 or `b` equals 3. Otherwise the return value is **FALSE**.

Example 2

```
VAR num mynum;  
VAR string mystring;  
VAR bool mybool;  
VAR bool result;  
...  
result := mystring="Hello" OR mynum<15 AND mybool;
```

The return value of `result` is **TRUE** if `mystring` is "Hello". Or if both `mynum` is smaller than 15 and `mybool` is **TRUE**. Otherwise the return value is **FALSE**.

The **AND** statement is evaluated first, thereafter the **OR** statement. This is illustrated by the parentheses in the below row.

```
result := mystring="Hello" OR (mynum<15 AND mybool);
```

Return value

Data type: `bool`

The return value is **TRUE** if one or both of the conditional expressions are correct, otherwise the return value is **FALSE**.

Syntax

```
<expression of bool> OR <expression of bool>
```

A function with a return value of data type `bool`.

Related information

For information about	See
AND	AND - Evaluates a logical value on page 1151
XOR	XOR - Evaluates a logical value on page 1596
NOT	NOT - Inverts a logical value on page 1375
Expressions	<i>Technical reference manual - RAPID Overview</i>

2.131 OrientZYX - Builds an orient from Euler angles

Usage

`OrientZYX` (*Orient from Euler ZYX angles*) is used to build an orient type variable out of Euler angles.

Basic examples

The following example illustrates the function `OrientZYX`.

Example 1

```
VAR num anglex;
VAR num angley;
VAR num anglez;
VAR pose object;
...
object.rot := OrientZYX(anglez, angley, anglex)
```

Return value

Data type: orient

The orientation made from the Euler angles.

Arguments

`OrientZYX` (ZAngle YAngle XAngle)



Note

The rotations will be performed in the following order:

- 1 rotation around the z axis
- 2 rotation around the new y axis
- 3 rotation around the new x axis

ZAngle

Data type: num

The rotation, in degrees, around the Z axis.

YAngle

Data type: num

The rotation, in degrees, around the Y axis.

XAngle

Data type: num

The rotation, in degrees, around the X axis.

Syntax

```
OrientZYX '('
  [ZAngle ':='] <expression (IN) of num> ','
  [YAngle ':='] <expression (IN) of num> ','
  [XAngle ':='] <expression (IN) of num> ')'
```

Continues on next page

2 Functions

2.131 OrientZYX - Builds an orient from Euler angles

RobotWare Base

Continued

A function with a return value of the data type `orient`.

Related information

For information about	See
Mathematical instructions and functions	<i>Technical reference manual - RAPID Overview, section Mathematics</i>

2.132 ORobT - Removes the program displacement from a position

Usage

ORobT (*Object Robot Target*) is used to transform a robot position from the program displacement coordinate system to the object coordinate system and/or to remove an offset for the external axes.

Basic examples

The following example illustrates the function ORobT.

See also [More examples on page 1388](#).

Example 1

```
VAR robtarget p10;
VAR robtarget p11;
VAR num wobj_diameter;

p10 := CRobT(\Tool:=tool1 \WObj:=wobj_diameter);
p11 := ORobT(p10);
```

The current positions of the robot and the external axes are stored in p10 and p11. The values stored in p10 are related to the ProgDisp/ExtOffs coordinate system. The values stored in p11 are related to the object coordinate system without any program displacement and any offset on the external axes.

Return value

Data type: robtarget

The transformed position data.

Arguments

ORobT (OrgPoint [\InPDisp] | [\InEOffs])

OrgPoint

Original Point

Data type: robtarget

The original point to be transformed.

[\InPDisp]

In Program Displacement

Data type: switch

Returns the TCP position in the ProgDisp coordinate system, that is, removes external axes offset only.

[\InEOffs]

In External Offset

Data type: switch

Returns the external axes in the offset coordinate system, that is, removes program displacement for the robot only.

Continues on next page

2 Functions

2.132 ORobT - Removes the program displacement from a position

RobotWare Base

Continued

More examples

More examples of how to use the function ORobT are illustrated below.

Example 1

```
p10 := ORobT(p10 \InEOffs );
```

The ORobT function will remove any program displacement that is active, leaving the TCP position relative to the object coordinate system. The external axes will remain in the offset coordinate system.

Example 2

```
p10 := ORobT(p10 \InPDisp );
```

The ORobT function will remove any offset of the external axes. The TCP position will remain in the ProgDisp coordinate system.

Syntax

```
ORobT '('  
  [ OrgPoint ':' ] < expression (IN) of robtargt >  
  ['\ ' InPDisp] | ['\ ' InEOffs] ')'
```

A function with a return value of the data type robtargt.

Related information

For information about	See
Definition of program displacement for the robot	PDispOn - Activates program displacement on page 540 PDispSet - Activates program displacement using known frame on page 545
Definition of offset for external axes	EOffsOn - Activates an offset for additional axes on page 191 EOffsSet - Activates an offset for additional axes using known values on page 193
Coordinate systems	<i>Technical reference manual - RAPID Overview, section Motion and I/O principles - Coordinate systems</i>

2.133 ParIdPosValid - Valid robot position for parameter identification

Usage

ParIdPosValid (*Parameter Identification Position Valid*) checks whether the robot position is valid for the current parameter identification, such as load identification of tool or payload.

This instruction can only be used in the `main` task or, if in a *MultiMove* system, in motion tasks.

Basic examples

The following example illustrates the function ParIdPosValid.

Example 1

```
VAR jointtarget joints;
VAR bool valid_joints{12};

! Check if valid robot type
IF ParIdRobValid(TOOL_LOAD_ID) <> ROB_LOAD_VAL THEN
  EXIT;
ENDIF
! Read the current joint angles
joints := CJointT();
! Check if valid robot position
IF ParIdPosValid (TOOL_LOAD_ID, joints, valid_joints) = TRUE THEN
  ! Valid position for load identification
  ! Continue with LoadId
  ...
ELSE
  ! Not valid position for one or several axes for load
  ! identification
  ! Move the robot to the output data given in variable joints
  ! and do ParIdPosValid once again
  ...
ENDIF
```

Check whether robot position is valid before doing load identification of tool.

Return value

Data type: bool

TRUE if robot position is valid for current parameter identification.

FALSE if robot position is not valid for current parameter identification.

Arguments

ParIdPosValid (ParIdType Pos AxValid [\ConfAngle])

Continues on next page

2 Functions

2.133 ParIdPosValid - Valid robot position for parameter identification

RobotWare Base

Continued

ParIdType

Data type: paridnum

Type of parameter identification as defined in table below

Value	Symbolic constant	Comment
1	TOOL_LOAD_ID	Identify tool load
2	PAY_LOAD_ID	Identify payload (Ref. instruction GripLoad)
3	IRBP_K	Identify External Manipulator IRBP K load
4	IRBP_L	Identify External Manipulator IRBP L load
4	IRBP_C	Identify External Manipulator IRBP C load
4	IRBP_C_INDEX	Identify External Manipulator IRBP C_INDEX load
4	IRBP_T	Identify External Manipulator IRBP T load
5	IRBP_R	Identify External Manipulator IRBP R load
6	IRBP_A	Identify External Manipulator IRBP A load
6	IRBP_B	Identify External Manipulator IRBP B load
6	IRBP_D	Identify External Manipulator IRBP D load

Pos

Data type: jointtarget

Variable specifies the actual joint angles for all robot and external axes. The variable is updated by ParIdPosValid according to the table below.

Input axis joint value	Output axis joint value
Valid	Not changed
Not valid	Changed to suitable value

AxValid

Data type: bool

Array variable with 12 elements corresponding to 6 robot and 6 external axes. The variable is updated by ParIdPosValid according to the table below.

Input axis joint value in Pos	Output status in AxValid
Valid	TRUE
Not valid	FALSE

Continues on next page

[\ConfAngle]

Data type: num

Optional argument for specification of specific configuration angle +/- degrees to be used for parameter identification.

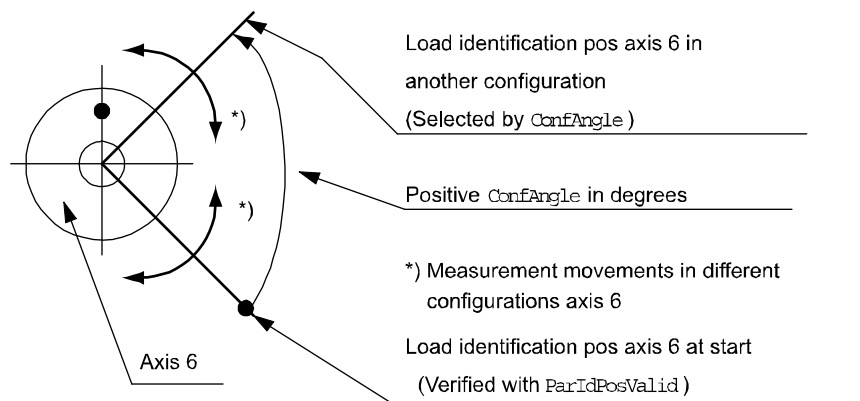

xx0500002493

Default + 90 degrees if this argument is not specified.

Min. + or - 30 degrees. Optimum + or - 90 degrees.

Error handling

The following recoverable errors are generated and can be handled in an error handler. The system variable `ERRNO` will be set to:

Name	Cause of error
ERR_PID_RAISE_PP	An error occurs.

Syntax

```
ParIdPosValid '('
  [ ParIdType ':=' ] <expression (IN) of paridnum> ','
  [ Pos ':=' ] <variable (VAR) of jointtarget> ','
  [ AxValid ':=' ] <array variable {*} (VAR) of bool>
  [ '\ ' ConfAngle ':=' <expression (IN) of num> ] ')'
```

A function with a return value of the data type `bool`.

Related information

For information about	See
Type of parameter identification	paridnum - Type of parameter identification on page 1707
Valid robot type	ParIdRobValid - Valid robot type for parameter identification on page 1392
Load identification of tool or payload	LoadId - Load identification of tool or payload on page 347
Load identification of positioners (IRBP)	ManLoadIdProc - Load identification of IRBP manipulators on page 354

2 Functions

2.134 ParIdRobValid - Valid robot type for parameter identification

RobotWare Base

2.134 ParIdRobValid - Valid robot type for parameter identification

Usage

ParIdRobValid (*Parameter Identification Robot Valid*) checks whether the robot or manipulator type is valid for the current parameter identification, such as load identification of tool or payload.

This instruction can only be used in the main task T_ROB1 or, if in a *MultiMove* system, in Motion tasks.

Basic examples

The following example illustrates the function ParIdRobValid.

Example 1

```
TEST ParIdRobValid (TOOL_LOAD_ID)
CASE ROB_LOAD_VAL:
  ! Possible to do load identification of tool in actual robot
  type
  ...
CASE ROB_LM1_LOAD_VAL:
  ! Only possible to do load identification of tool with
  ! IRB 6400FHD if actual load < 200 kg
  ...
CASE ROB_NOT_LOAD_VAL:
  ! Not possible to do load identification of tool in actual
  robot type
  ...
ENDTEST
```

Return value

Data type: paridvalidnum

Whether the specified parameter identification can be performed with the current robot or manipulator type, as defined in the table below.

Value	Symbolic constant	Comment
10	ROB_LOAD_VAL	Valid robot or manipulator type for the actual parameter identification
11	ROB_NOT_LOAD_VAL	Not valid type for the actual parameter identification
12	ROB_LM1_LOAD_VAL	Valid robot type IRB 6400FHD for the actual parameter identification if actual load < 200 kg

Arguments

ParIdRobValid(ParIdType [\MechUnit] [\AxisNo])

ParIdType

Data type: paridnum

Type of parameter identification as defined in table below.

Value	Symbolic constant	Comment
1	TOOL_LOAD_ID	Identify robot tool load

Continues on next page

Value	Symbolic constant	Comment
2	PAY_LOAD_ID	Identify robot payload (Ref. instruction GripLoad)
3	IRBP_K	Identify External Manipulator IRBP K load
4	IRBP_L	Identify External Manipulator IRBP L load
4	IRBP_C	Identify External Manipulator IRBP C load
4	IRBP_C_INDEX	Identify External Manipulator IRBP C_INDEX load
4	IRBP_T	Identify External Manipulator IRBP T load
5	IRBP_R	Identify External Manipulator IRBP R load
6	IRBP_A	Identify External Manipulator IRBP A load
6	IRBP_B	Identify External Manipulator IRBP B load
6	IRBP_D	Identify External Manipulator IRBP D load

[\MechUnit]

Mechanical Unit

Data type: mecunit

Mechanical Unit used for the load identification. Only to be specified for external manipulator. If this argument is omitted the TCP-robot in the task is used.

[\AxisNo]

Axis number

Data type: num

Axis number within the mechanical unit which holds the load to be identified. Only to be specified for external manipulator.

When the argument \MechUnit is used, then \AxisNo must be used. The argument \AxisNo can not be used without \MechUnit.

Error handling

The following recoverable errors are generated and can be handled in an error handler. The system variable ERRNO will be set to:

Name	Cause of error
ERR_PID_RAISE_PP	An error occurs.

Syntax

```
ParIdRobValid '('
  [ParIdType ':=' ] <expression (IN) of paridnum>
  ['\MechUnit ':=' <variable (VAR) of mecunit>]
  ['\AxisNo ':=' <expression (IN) of num>] ')'

```

A function with a return value of the data type paridvalidnum.

Related information

For information about	See
Type of parameter identification	paridnum - Type of parameter identification on page 1707

Continues on next page

2 Functions

2.134 ParIdRobValid - Valid robot type for parameter identification

RobotWare Base

Continued

For information about	See
Mechanical unit to be identified	mecunit - Mechanical unit on page 1690
Result of this function	paridvalidnum - Result of ParIdRobValid on page 1709
Valid robot position	ParIdPosValid - Valid robot position for parameter identification on page 1389
Load identification of robot tool load or payload	LoadId - Load identification of tool or payload on page 347
Load identification of positioner loads	ManLoadIdProc - Load identification of IRBP manipulators on page 354

2.135 PathLengthGet - Reads the current path-length value of the counter

Usage

`PathLengthGet` is used to read the current value of the counter that measures the path-length travelled by the robot's TCP. The returned value is in millimeters and is always measured relative the work object.

This function can be called at any time, but it is advisable that it is called when the robot is standing still to get a predictable behavior.

The path-length value is read for the TCP robot in actual or connected motion task.

Basic examples

The following example illustrates the function `PathLengthGet`.

Example 1

```
PathLengthStart;
MoveJ p10, v1000, z50, L10tip;
...
MoveL p40, v1000, fine, L10tip;
PathLengthStop;
TPWrite "PathLengthGet: "+ValToStr(PathLengthGet());
PathLengthReset;
```

This example read out the value of the counter that measures the path-length travelled by the robot's TCP. The value is then written to the FlexPendant.

Program execution

The path-length measurement applies for the next executed robot movement instruction of any type and is valid until a `PathLengthStop` instruction is executed. Path-length measurement is set to off, and the path-length measurement counter is set to zero when a `PathLengthReset` instruction is executed. The default value, path-length measurement off is automatically set:

- when using the restart mode *Reset RAPID*.
 - when loading a new program or a new module.
 - when starting program execution from the beginning.
 - when moving the program pointer to Main routine.
 - when moving the program pointer to a routine.
 - when moving the program pointer in such a way that the execution order is lost.
-

Limitations

Path-length measurements are only applicable for TCP-robots.

Syntax

```
PathLengthGet '(' ' ')
```

A function with a return value of the data type num.

Continues on next page

2 Functions

2.135 PathLengthGet - Reads the current path-length value of the counter

RobotWare Base

Continued

Related information

For information about	See
PathLengthReset	PathLengthReset - Resets the current path-length value of the counter on page 516
PathLengthStart	PathLengthStart - Activates the counter that monitors the path-length on page 518
PathLengthStop	PathLengthStop - Stops the counter that monitors the path-length on page 520

2.136 PathLevel - Get current path level

Usage

`PathLevel` is used to get the current path level. This function will show whether the task is executing on the original level or if the original movement path has been stored and a new temporary movement is executing. Read more about *Path Recovery* in *Application manual - Controller software IRC5*.

Basic examples

The following example illustrates the function `PathLevel`.

See also [More examples on page 1397](#).

Example 1

```
VAR num level;
level:= PathLevel();
```

Variable `level` will be 1 if executed in an original movement path or 2 if executed in a temporary new movement path.

Return value

Data type: num

There are two possible return values.

Return value	Description
1	Executing in original movement path.
2	Executing in StorePath level, a temporary new movement path.

More examples

One more example of how to use the function `PathLevel` is illustrated below.

Example 1

```
...
MoveL p100, v100, z10, tool1;
StopMove;
StorePath;
p:= CRobT(\Tool:=tool1);
!New temporary movement
MoveL p1, v100, fine, tool1;
...
level:= PathLevel();
...
MoveL p, v100, fine, tool1;
RestoPath;
StartMove;
...

```

Variable `level` will be 2.

Continues on next page

2 Functions

2.136 PathLevel - Get current path level

RobotWare Base

Continued

Limitations

RobotWare option Path Recovery must be installed to be able to use function PathLevel at path level 2

Syntax

```
PathLevel '(' '')
```

A function with a return value of the data type num.

Related information

For information about	See
Path recovery	<i>Application manual - Controller software IRC5</i>
Store and restore path	StorePath - Stores the path when an interrupt occurs on page 826 RestoPath - Restores the path after an interrupt on page 618
Stop and start move	StartMove - Restarts robot movement on page 791 StopMove - Stops robot movement on page 820

2.137 PathRecValidBwd - Is there a valid backward path recorded

Usage

PathRecValidBwd is used to check if the path recorder is active and if a recorded backward path is available.

Basic examples

The following example illustrates the function PathRecValidBwd.

See also [More examples on page 1400](#).

Example 1

```
VAR bool bwd_path;
VAR pathrecid fixture_id;
bwd_path := PathRecValidBwd (\ID:=fixture_id);
```

The variable `bwd_path` is set to `TRUE` if it is possible to back-up to the position with identifier `fixture_id`. If not, `bwd_path` is set to `FALSE`.

Return value

Data type: `bool`

The return value of the function can be determined from following flow chart:

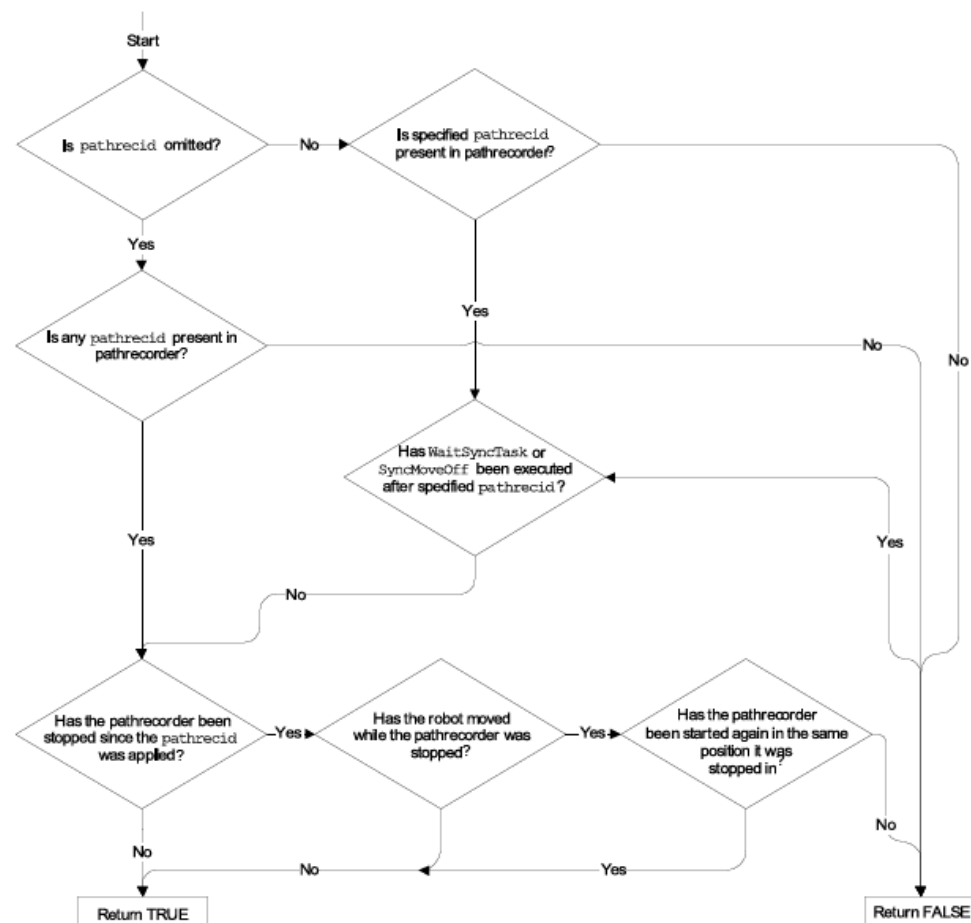

xx0500002132

Continues on next page

2 Functions

2.137 PathRecValidBwd - Is there a valid backward path recorded

Path Recovery

Continued

Arguments

PathRecValidBwd ([\ID])

[\ID]

Identifier

Data type: pathrecid

Variable that specifies the name of the recording start position. Data type pathrecid is a non-value type, only used as an identifier for naming the recording position.

Program execution

Before the path recorder is ordered to move backwards with PathRecMoveBwd it is possible to check whether a valid recorded path is present with PathRecValidBwd.

More examples

The following examples illustrate the function PathRecValidBwd.

Example 1

```
PathRecStart id1;
MoveL p1, vmax, z50, tool1;
MoveL p2, vmax, z50, tool1;
bwd_path := PathRecValidBwd (\ID := id1);
```

The path recorder is started and two move instructions are executed. PathRecValidBwd will return TRUE and the available backup path will be: From p2 to p1 to the start position.

Example 2

```
PathRecStart id1;
MoveL p1, vmax, z50, tool1;
MoveL p2, vmax, z50, tool1;
PathRecStop \Clear;
bwd_path:= PathRecValidBwd (\ID := id1);
```

The path recorder is started and two move instructions are executed. Then the path recorder is stopped and cleared. PathRecValidBwd will return FALSE.

Example 3

```
PathRecStart id1;
MoveL p1, vmax, z50, tool1;
PathRecStart id2;
MoveL p2, vmax, z50, tool1;
bwd_path := PathRecValidBwd ();
```

The path recorder is started and one move instruction is executed. Then, an additional path identifier is started followed by a move instruction. PathRecValidBwd will return TRUE and the backup path will be: From p2 to p1.

Example 4

```
PathRecStart id1;
MoveL p1, vmax, z50, tool1;
```

Continues on next page

2.137 PathRecValidBwd - Is there a valid backward path recorded

*Path Recovery**Continued*

```

WaitSyncTask sync101, tasklist_r101;
MoveL p2, vmax, z50, tool1;
bwd_path1 := PathRecValidBwd ();
bwd_path2 := PathRecValidBwd (\ID := id1);

```

Executing above program will result in that the boolean variable `bwd_path1` will be assigned **TRUE** since a valid backwards path to the `WaitSyncTask` statement exists. The boolean variable `bwd_path2` will be assigned **FALSE** since it isn't possible to back up above a `WaitSyncTask` statement.

Syntax

```

PathRecValidBwd '('
  ['\' ID :=' < variable (VAR) of pathrecid >] ')'

```

A function with a return value of the data type `bool`.

Related information

For information about	See
Path Recorder Identifiers	pathrecid - Path recorder identifier on page 1711
Start - stop the path recorder	PathRecStart - Start the path recorder on page 531 PathRecStop - Stop the path recorder on page 534
Play the path recorder backward	PathRecMoveBwd - Move path recorder backwards on page 522
Check if a valid forward path exists	PathRecValidFwd - Is there a valid forward path recorded on page 1402
Play the path recorder forward	PathRecMoveFwd - Move path recorder forward on page 528
Motion in general	Technical reference manual - RAPID Overview

2 Functions

2.138 PathRecValidFwd - Is there a valid forward path recorded

Path Recovery

2.138 PathRecValidFwd - Is there a valid forward path recorded

Usage

`PathRecValidFwd` is used to check if the path recorder can be used to move forward. The ability to move forward with the path recorder implies that the path recorder must have been ordered to move backwards earlier.

Basic examples

The following example illustrates the function `PathRecValidFwd`.

See also [More examples on page 1403](#).

Example 1

```
VAR bool fwd_path;  
VAR pathrecid fixture_id;  
  
fwd_path:= PathRecValidFwd (\ID:=fixture_id);
```

The variable `fwd_path` is set to `TRUE` if it is possible to move forward to the position with the with identifier `fixture_id`. If not, `fwd_path` is set to `FALSE`.

Return value

Data type: `bool`

The return value of `PathRecValidFwd` **without** specified `\ID` is:

`TRUE` if:

- The path recorder has moved the robot backwards, using `PathRecMoveBwd`.
- The robot has not moved away from the path executed by `PathRecMoveBwd`.

`FALSE` if:

- The above stated conditions are not met.

The return value of `PathRecValidFwd` **with** specified `\ID` is:

`TRUE` if:

- The path recorder has moved the robot backwards, using `PathRecMoveBwd`.
- The robot has not moved away from the path executed by `PathRecMoveBwd`.
- The specified `\ID` was passed during the backward motion.

`FALSE` if:

- The above stated conditions are not met.
-

Arguments

```
PathRecValidFwd ([\ID])
```

`[\ID]`

Identifier

Data type: `pathrecid`

Variable that specifies the name of the recording start position. Data type `pathrecid` is a non-value type, only used as an identifier for naming the recording position.

Continues on next page

Program execution

After the path recorder has been ordered to move backwards using `PathRecMoveBwd` it is possible to check if a valid recorded path to move the robot forward exists. If the identifier `\ID` is omitted `PathRecValidFwd` returns if it is possible to move forward to the position where the backwards movement was initiated.

More examples

The following example illustrates the function `PathRecValidFwd`.

Example 1

```

VAR pathrecid id1;
VAR pathrecid id2;
VAR pathrecid id3;

PathRecStart id1;
MoveL p1, vmax, z50, tool1;
PathRecStart id2;
MoveL p2, vmax, z50, tool1;
PathRecStart id3;
!See figures 1 and 8 in the following table.
MoveL p3, vmax, z50, tool1;
ERROR
  StorePath;
  IF PathRecValidBwd(\ID:=id3) THEN
    !See figure 2 in the following table.
    PathRecMoveBwd \ID:=id3;
    ! Do some other operation
  ENDIF
  IF PathRecValidBwd(\ID:=id2) THEN
    !See figure 3 in the following table.
    PathRecMoveBwd \ID:=id2;
    ! Do some other operation
  ENDIF
  !See figure 4 in the following table.
  PathRecMoveBwd;
  ! Do final service action
  IF PathRecValidFwd(\ID:=id2) THEN
    !See figure 5 in the following table.
    PathRecMoveFwd \ID:=id2;
    ! Do some other operation
  ENDIF
  IF PathRecValidFwd(\ID:=id3) THEN
    !See figure 6 in the following table.
    PathRecMoveFwd \ID:=id3;
    ! Do some other operation
  ENDIF
  !See figure 7 in the following table.
  PathRecMoveFwd;
  RestoPath;

```

Continues on next page

2 Functions

2.138 PathRecValidFwd - Is there a valid forward path recorded

Path Recovery

Continued

StartMove;

RETRY;

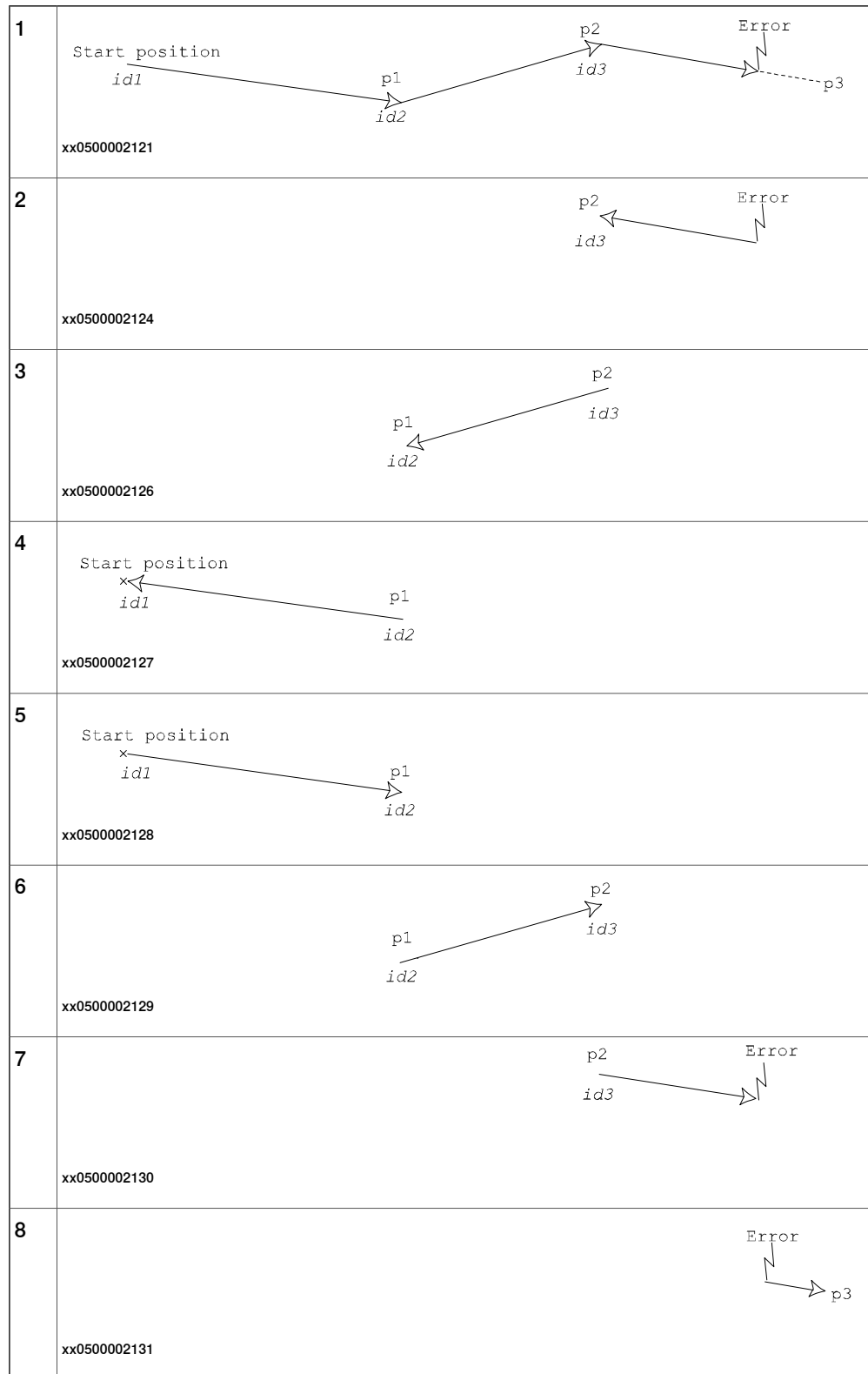

The example above will start the path recorder and add identifiers at three different locations along the executed path. The picture above references the example code and describes how the robot will move in the case of an error while executing

Continues on next page

2.138 PathRecValidFwd - Is there a valid forward path recorded

Path Recovery

Continued

towards point p3. The `PathRecValidBwd` and `PathRecValidFwd` are used respectively as it is not possible in advance to determine where in the program a possible error occurs.

Syntax

```
PathRecValidFwd '('
  ['\' ID ' := ' < variable (VAR) of pathrecid > ] ')'
```

A function with a return value of the data type `bool`.

Related information

For information about	See
Path Recorder Identifiers	pathrecid - Path recorder identifier on page 1711
Start - stop the path recorder	PathRecStart - Start the path recorder on page 531 PathRecStop - Stop the path recorder on page 534
Check if valid backward path exists	PathRecValidBwd - Is there a valid backward path recorded on page 1399
Play the path recorder backward	PathRecMoveBwd - Move path recorder backwards on page 522
Play the path recorder forward	PathRecMoveFwd - Move path recorder forward on page 528
Motion in general	Technical reference manual - RAPID Overview

2 Functions

2.139 PFRestart - Check interrupted path after power failure

RobotWare Base

2.139 PFRestart - Check interrupted path after power failure

Usage

`PFRestart` (*Power Failure Restart*) is used to check if the path has been interrupted at power failure. If so, some specific actions might be needed. The function checks the path on current level, base level, or on interrupt level.

Basic examples

The following example illustrates the function `PFRestart`.

Example 1

```
IF PFRestart() = TRUE THEN
```

It is checked, if an interrupted path exists on the current level. If so the function will return `TRUE`.

Return value

Data type: `bool`

`TRUE` if an interrupted path exists on the specified path level, otherwise `FALSE`.

Arguments

```
PFRestart([\Base] | [\Irpt])
```

[\Base]

Base Level

Data type: `switch`

Returns `TRUE` if an interrupted path exists on base level.

[\Irpt]

Interrupt Level

Data type: `switch`

Returns `TRUE` if an interrupted path exists on `StorePath` level.

If no argument is given, the function will return `TRUE` if an interrupted path exists on current level.

Syntax

```
PFRestart '('  
  ['\ ' Base] | ['\ ' Irpt] ')'
```

A function with a return value of the data type `bool`.

Related information

For information about	See
<i>Advanced RAPID</i>	<i>Product specification - Controller software IRC5</i>

2.140 PoseInv - Inverts pose data

Usage

`PoseInv` (*Pose Invert*) calculates the reverse transformation of a `pose`.

Basic examples

The following example illustrates the function `PoseInv`.

Example 1

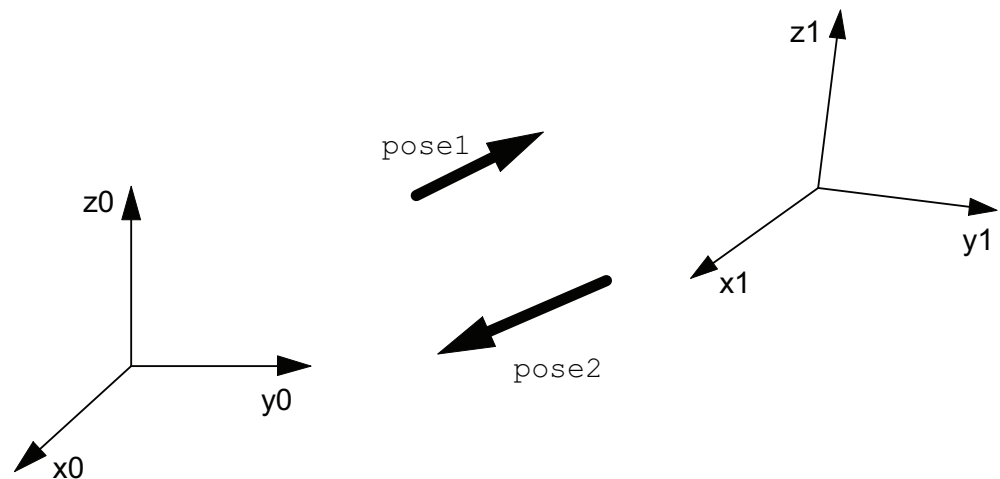

xx0500002443

`pose1` represents the coordinates system 1 related to the coordinate system 0. The transformation giving the coordinate system 0 related to the coordinate system 1 is obtained by the reverse transformation, stored in `pose2`.

```
VAR pose pose1;
VAR pose pose2;
...
pose2 := PoseInv(pose1);
```

Return value

Data type: `pose`
The value of the reverse pose.

Arguments

`PoseInv` (`Pose`)

`Pose`

Data type: `pose`
The `pose` to invert.

Syntax

```
PoseInv(' '
  [Pose ':=' ] <expression (IN) of pose>
  ' ')
```

A function with a return value of the data type `pose`.

Continues on next page

2 Functions

2.140 PosInv - Inverts pose data

RobotWare Base

Continued

Related information

For information about	See
Mathematical instructions and functions	<i>Technical reference manual - RAPID Overview</i>

2.141 PoseMult - Multiplies pose data

Usage

`PoseMult` (*Pose Multiply*) is used to calculate the product of two pose transformations. A typical use is to calculate a new pose as the result of a displacement acting on an original pose.

Basic examples

The following example illustrates the function `PoseMult`.

Example 1

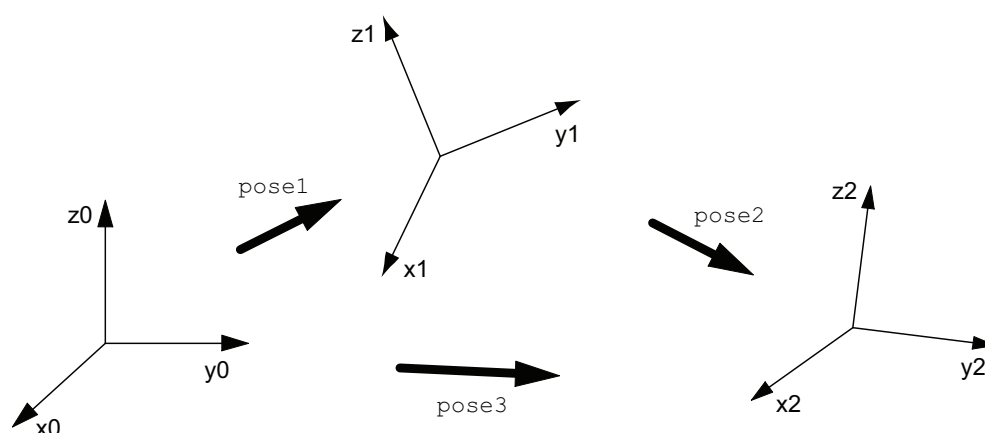

xx0500002444

`pose1` represents the coordinate system 1 related to the coordinate system 0. `pose2` represents the coordinate system 2 related to the coordinate system 1. The transformation giving `pose3`, the coordinate system 2 related to the coordinate system 0, is obtained by the product of the two transformations:

```
VAR pose pose1;
VAR pose pose2;
VAR pose pose3;
...
pose3 := PoseMult(pose1, pose2);
```

Return value

Data type: `pose`

The value of the product of the two poses.

Arguments

`PoseMult (Pose1 Pose2)`

`Pose1`

Data type: `pose`

The first pose.

`Pose2`

Data type: `pose`

Continues on next page

2 Functions

2.141 PoseMult - Multiplies pose data

RobotWare Base

Continued

The second pose.

Syntax

```
PoseMult '('  
  [Pose1 ':=' ] <expression (IN) of pose> ','  
  [Pose2 ':=' ] <expression (IN) of pose> ')'
```

A function with a return value of the data type `pose`.

Related information

For information about	See
Mathematical instructions and functions	<i>Technical reference manual - RAPID Overview</i>

2.142 PoseVect - Applies a transformation to a vector

Usage

`PoseVect` (*Pose Vector*) is used to calculate the product of a pose and a vector. It is typically used to calculate a vector as the result of the effect of a displacement on an original vector.

Basic examples

The following example illustrates the function `PoseVect`.

Example 1

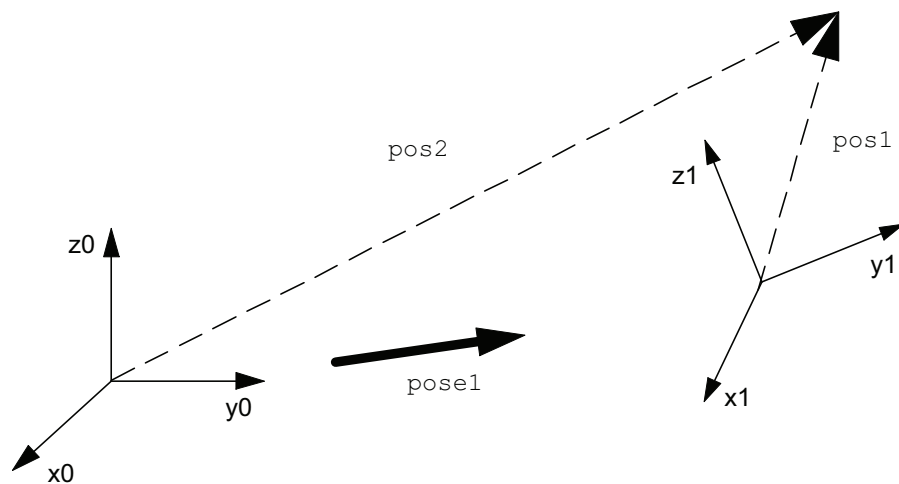

xx0500002445

`pose1` represents the coordinates system 1 related to the coordinate system 0.
`pos1` is a vector related to coordinate system 1. The corresponding vector related to coordinate system 0 is obtained by the product;

```
VAR pose pose1;
VAR pos pos1;
VAR pos pos2;
...
...
pos2:= PoseVect(pose1, pos1);
```

Return value

Data type: `pos`

The value of the product of the pose and the original `pos`.

Arguments

`PoseVect (Pose Pos)`

`Pose`

Data type: `pose`

The transformation to be applied.

Continues on next page

2 Functions

2.142 PoseVect - Applies a transformation to a vector

RobotWare Base

Continued

Pos

Data type: pos

The pos to be transformed.

Syntax

```
PoseVect '('  
  [Pose ':=' ] <expression (IN) of pose> ','  
  [Pos ':=' ] <expression (IN) of pos> ')'
```

A function with a return value of the data type pos.

Related information

For information about	See
Mathematical instructions and functions	<i>Technical reference manual - RAPID Overview</i>

2.143 Pow - Calculates the power of a value

Usage

`Pow` (*Power*) is used to calculate the exponential value in any base.

Basic examples

The following example illustrates the function `Pow`.

Example 1

```

VAR num x;
VAR num y;
VAR num reg1;
...
reg1:= Pow(x, y);
reg1 is assigned the value xy.

```

Return value

Data type: num

The value of the `Base` raised to the power of the `Exponent`, that is, `BaseExponent`.

Arguments

`Pow (Base Exponent)`

Base

Data type: num

The base argument value.

Exponent

Data type: num

The exponent argument value.

Limitations

The execution of the function `xy` will give an error if:

- `x < 0` and `y` is not an integer;
- `x = 0` and `y ≤ 0`.

Syntax

```

Pow '('
  [Base ':=' ] <expression (IN) of num> ','
  [Exponent ':=' ] <expression (IN) of num> ')'

```

A function with a return value of the data type `num`.

Related information

For information about	See
Mathematical instructions and functions	<i>Technical reference manual - RAPID Overview</i>

2 Functions

2.144 PowDnum - Calculates the power of a value

RobotWare Base

2.144 PowDnum - Calculates the power of a value

Usage

PowDnum (*Power Dnum*) is used to calculate the exponential value in any base.

Basic examples

The following example illustrates the function PowDnum.

Example 1

```
VAR dnum x;  
VAR num y  
VAR dnum value;  
...  
value:= PowDnum(x, y);  
value is assigned the value  $x^y$ .
```

Return value

Data type: dnum

The value of the Base raised to the power of the Exponent, that is, $\text{Base}^{\text{Exponent}}$.

Arguments

PowDnum (Base Exponent)

Base

Data type: dnum

The base argument value.

Exponent

Data type: num

The exponent argument value.

Limitations

The execution of the function x^y will give an error if:

- $x < 0$ and y is not an integer;
 - $x = 0$ and $y \leq 0$.
-

Syntax

```
PowDnum '('  
  [Base ':=' ] <expression (IN) of dnum> ','  
  [Exponent ':=' ] <expression (IN) of num> ')'
```

A function with a return value of the data type dnum.

Related information

For information about	See
Mathematical instructions and functions	<i>Technical reference manual - RAPID Overview</i>

2.145 PPMovedInManMode - Test whether the program pointer is moved in manual mode**Usage**

PPMovedInManMode returns TRUE if the user has moved the program pointer while the controller is in manual mode - that is, operator key is at Man Reduced Speed or Man Full Speed. The program pointer moved state is reset when the key is switched from Auto to Man, or when using the instruction `ResetPPMoved`.

Basic examples

The following example illustrates the function `PPMovedInManMode`.

Example 1

```
IF PPMovedInManMode() THEN
  WarnUserOfPPMovement;
  DoJob;
ELSE
  DoJob;
ENDIF
```

Return value

Data type: `bool`

TRUE if the program pointer has been moved by the user while in manual mode.

Program execution

Test if the program pointer for the current program task has been moved in manual mode.

Syntax

```
PPMovedInManMode '(' ' ')
```

A function with a return value of the data type `bool`.

Related information

For information about	See
Test whether program pointer has moved	IsStopStateEvent - Test whether moved program pointer on page 1353
Reset state of moved program pointer in manual mode	ResetPPMoved - Reset state for the program pointer moved in manual mode on page 615

2 Functions

2.146 Present - Tests if an optional parameter is used
RobotWare Base

2.146 Present - Tests if an optional parameter is used

Usage

`Present` is used to test if an optional argument has been used when calling a routine.

An optional parameter may not be used if it was not specified when calling the routine. This function can be used to test if a parameter has been specified, in order to prevent errors from occurring.

Basic examples

The following example illustrates the function `Present`.

See also [More examples on page 1416](#).

Example 1

```
PROC feeder (\switch on | switch off)
  IF Present (on) Set do1;
  IF Present (off) Reset do1;
ENDPROC
```

The output `do1`, which controls a feeder, is set or reset depending on the argument used when calling the routine.

Return value

Data type: `bool`

TRUE = The parameter value or a switch has been defined when calling the routine.

FALSE = The parameter value or a switch has not been defined.

Arguments

`Present (OptPar)`

OptPar

Optional Parameter

Data type: `anytype`

The name of the optional parameter to be tested.

More examples

The following example illustrates the function `Present`.

Example 1

```
PROC glue (\switch on, num glueflow, robtarget topoint, speeddata
  speed, zonedata zone, PERS tooldata tool, \PERS wobjdata wobj)
  IF Present (on) PulseDO glue_on;
  SetAO gluesignal, glueflow;
  IF Present (wobj) THEN
    MoveL topoint, speed, zone, tool \WObj:=wobj;
  ELSE
    MoveL topoint, speed, zone, tool;
  ENDIF
ENDPROC
```

Continues on next page

A glue routine is made. If the argument `\on` is specified when calling the routine, a pulse is generated on the signal `glue_on`. The robot then sets an analog output `gluesignal`, which controls the glue gun, and moves to the end position. As the `wobj` parameter is optional, different `MoveL` instructions are used depending on whether this argument is used or not.

Syntax

```
Present '('  
  [OptPar ':='] <reference (REF) of anytype> ')'
```

A REF parameter requires, in this case, the optional parameter name.

A function with a return value of the data type `bool`.

Related information

For information about	See
Routine parameters	<i>Technical reference manual - RAPID Overview</i>

2 Functions

2.147 ProgMemFree - Get the size of free program memory

RobotWare Base

2.147 ProgMemFree - Get the size of free program memory

Usage

ProgMemFree (*Program Memory Free*) is used to get the size of free program memory.

Basic examples

The following example illustrates the function ProgMemFree.

Example 1

```
FUNC num module_size(string file_path)
  VAR num pgmfree_before;
  VAR num pgmfree_after;

  pgmfree_before:=ProgMemFree();
  Load \Dynamic, file_path;
  pgmfree_after:=ProgMemFree();
  Unload file_path;
  RETURN (pgmfree_before-pgmfree_after);
ENDFUNC
```

ProgMemFree is used in a function that returns the value for how much memory a module allocates in the program memory.

Return value

Data type: num

The size of free program memory in bytes.

Syntax

```
ProgMemFree '(' ' ')
```

A function with a return value of the data type num.

Related information

For information about	See
Load a program module	Load - Load a program module during execution on page 342
Unload a program module	UnLoad - Unload a program module during execution on page 1010

2.148 PrxGetMaxRecordpos - Get the maximum sensor position

Machine Synchronization

2.148 PrxGetMaxRecordpos - Get the maximum sensor position

Usage

`PrxGetMaxRecordpos` is used to return the maximum position in mm of the active record.

The maximum sensor position can be used for scaling or limiting `max_sync` argument in the `SyncToSensor` instruction.

Basic example

```
maxpos:=PrxGetMaxRecordpos Ssync1;
```

Gets the maximum position for the active profile for the mechanical unit `Ssync1`.

Return value

Data type: `num`

The maximum position (in mm) of the recorded profile of sensor movement.

Arguments

```
PrxGetMaxRecordpos MechUnit
```

`MechUnit`

Data type: `mechunit`

The moving mechanical unit object to which the robot movement is synchronized.

Program execution

The recording must be finished and the record must be active.

Syntax

```
PrxGetMaxRecordpos '('  
  [ MechUnit ':=' ] < expression (IN) of mechunit > ')'
```

A function with a return value of the data type `num`.

Related information

For information about	See
<i>Machine Synchronization</i>	<i>Application manual - Controller software IRC5</i>

2 Functions

2.149 Rand - Generate a random number

RobotWare Base

2.149 Rand - Generate a random number

Usage

Rand is used to generate a random integer number between 0 and `RAND_MAX`.

Basic examples

The following example illustrates the function `Rand`.

Example 1

```
VAR num myrandomnumber;  
..  
myrandomnumber:=Rand();
```

Generate a random number and assign it to the variable `myrandomnumber`.

Return value

Data type: `num`

A random number between 0 and `RAND_MAX`. For a real robot controller, `RAND_MAX` is 65535, and for a virtual controller `RAND_MAX` is 32767.

Arguments

```
Rand ([\Seed] [\SeedEachNTime])
```

`\Seed`

Data type: `switch`

The current time is used to seed the random number generator if this switch is used. If the switch is not used the seed is done at first call to the function `Rand`, and the sequence of numbers generated will always be the same.

`\SeedEachNTime`

Data type: `num`

Sets up an internal counter that is decreased each time the `Rand` function is executed with optional argument `SeedEachNTime`. When the internal counter is 0 a new seed is done (with current time), and the internal counter is set to the value used in the optional argument `SeedEachNTime`.

Program execution

`Rand` is used to generate a random integer number between 0 and `RAND_MAX`.

In reality, pseudorandom numbers are not random at all. The numbers are computed using a fixed deterministic algorithm. The *seed* (argument `Seed`) is the starting point for a sequence of random numbers. If starting from the same seed, you will get the very same sequence.

The `Rand` function is using the current time as seed the first time it is executed. To make it more random it is possible to specify that it should use a new time as seed each time it is executed (with switch `Seed`), or after a number of times it has been executed (optional argument `SeedEachNTime`).

Continues on next page

If you never seed with a new starting point (time) for the random numbers and generate many numbers with `Rand`, you can see that the same number sequence is repeated.

More examples

More examples of the function `Rand` are illustrated below.

Example 1

```
VAR num random_numbers{6};
FOR i FROM 1 TO 6 DO
  random_numbers{i} := Rand()/RAND_MAX;
ENDFOR
```

In the example above `Rand` function generates 6 random numbers between 0 and 1, and stores them in the `random_numbers` array.

Example 2

```
VAR num rand_no;
Open "HOME:" \File:= "LOGFILE.txt", logfile \Write;
FOR i FROM 1 TO 5000 DO
  rand_no := Rand(\SeedEachNTime:=30);
  Write logfile, "\Num:=rand_no;
ENDFOR
```

In the example above `Rand` function generates 5000 random numbers and writes them to a file. Optional argument `SeedEachNTime` is used with value 30. Then a new seed is done to create a new random number series for every 30 times `Rand` function is executed.

Syntax

```
Rand '('
  ['\ ' Seed]
  ['\ ' SeedEachNTime' := ' <expression (IN) of num> ]')'
```

A function with a return value of the data type `num`.

2 Functions

2.150 RawBytesLen - Get the length of rawbytes data

RobotWare Base

2.150 RawBytesLen - Get the length of rawbytes data

Usage

`RawBytesLen` is used to get the current length of valid bytes in a rawbytes variable.

Basic examples

The following example illustrates the function `RawBytesLen`.

Example 1

```
VAR rawbytes from_raw_data;  
VAR rawbytes to_raw_data;  
VAR num integer := 8  
VAR num float := 13.4;  
ClearRawBytes from_raw_data;  
PackRawBytes integer, from_raw_data, 1 \IntX := INT;  
PackRawBytes float, from_raw_data, (RawBytesLen(from_raw_data)+1)  
  \Float4;  
CopyRawBytes from_raw_data, 1, to_raw_data, 3;
```

In this example the variable `from_raw_data` of type `rawbytes` is first cleared, that is, all bytes set to 0 (same as default at declaration). Then the value of `integer` is placed in the first 2 bytes and with help of the function `RawBytesLen` the value of `float` is placed in the next 4 bytes (starting at index 3).

After having filled `from_raw_data` with data, the contents (6 bytes) is copied to `to_raw_data`, starting at position 3.

Return value

Data type: `num`

The current length of valid bytes in a variable of type `rawbytes`; range 0 ... 1024.

In general, the current length of valid bytes in a `rawbytes` variable is updated by the system to be the last written byte in the `rawbytes` structure.

For details, see data type `rawbytes`, instruction `ClearRawBytes`, `CopyRawBytes`, `PackDNHeader`, `PackRawBytes`, and `ReadRawBytes`.

Arguments

`RawBytesLen (RawData)`

`RawData`

Data type: `rawbytes`

`RawData` is the data container whose current length of valid bytes shall be returned.

Program execution

During program execution the current length of valid bytes is returned.

Syntax

```
RawBytesLen '('  
  [RawData ':='] < variable (VAR) of rawbytes > ')'
```

A function with a return value of the data type `num`.

Continues on next page

Related information

For information about	See
rawbytes data	rawbytes - Raw data on page 1721
Clear the contents of rawbytes data	ClearRawBytes - Clear the contents of rawbytes data on page 145
Copy the contents of rawbytes data	CopyRawBytes - Copy the contents of rawbytes data on page 169
Pack DeviceNet header into rawbytes data	PackDNHeader - Pack DeviceNet Header into rawbytes data on page 505
Pack data into rawbytes data	PackRawBytes - Pack data into rawbytes data on page 508
Read rawbytes data	ReadRawBytes - Read rawbytes data on page 593
Unpack data from rawbytes data	UnpackRawBytes - Unpack data from rawbytes data on page 1013
Write rawbytes data	WriteRawBytes - Write rawbytes data on page 1108
File and I/O device handling	Application manual - Controller software IRC5

2 Functions

2.151 ReadBin - Reads a byte from a file or I/O device

RobotWare Base

2.151 ReadBin - Reads a byte from a file or I/O device

Usage

`ReadBin` (*Read Binary*) is used to read a byte (8 bits) from a file or I/O device. This function works on both binary and character-based files or I/O devices.

Basic examples

The following example illustrates the function `ReadBin`.

See also [More examples on page 1425](#).

Example 1

```
VAR num character;  
VAR iodev file1;  
...  
Open "HOME:", \File:= "FILE1.DOC", file1\Bin;  
character := ReadBin(file1);
```

A byte is read from the binary file `file1`.

Return value

Data type: `num`

A byte (8 bits) is read from a specified file or I/O device. This byte is converted to the corresponding positive numeric value and returned as a `num` data type. If a file is empty (end of file), `EOF_BIN` (the number -1) is returned.

Arguments

```
ReadBin (IODevice [\Time])
```

`IODevice`

Data type: `iodev`

The name (reference) of the file or I/O device to be read.

`[\Time]`

Data type: `num`

The max. time for the reading operation (timeout) in seconds. If this argument is not specified, the max. time is set to 60 seconds. To wait forever, use the predefined constant `WAIT_MAX`.

If this time runs out before the reading operation is finished, the error handler will be called with the error code `ERR_DEV_MAXTIME`. If there is no error handler, the execution will be stopped.

The timeout function is in use also during program stop and will be noticed by the RAPID program at program start.

Program execution

Program execution waits until a byte (8 bits) can be read from the file or I/O device.

At power fail restart, any open file or I/O device in the system will be closed and the I/O descriptor in the variable of type `iodev` will be reset.

Continues on next page

Predefined data

The constant `EOF_BIN` can be used to stop reading at the end of the file.

```
CONST num EOF_BIN := -1;
```

Error handling

The following recoverable errors are generated and can be handled in an error handler. The system variable `ERRNO` will be set to:

Name	Cause of error
<code>ERR_FILEACC</code>	An error occurs during reading.
<code>ERR_DEV_MAXTIME</code>	Time-out before the read operation is finished.

More examples

The following example illustrates the function `ReadBin`.

Example 1

```
VAR num bindata;
VAR iodev file;

Open "HOME:/myfile.bin", file \Read \Bin;
bindata := ReadBin(file);
WHILE bindata <> EOF_BIN DO
  TPWrite ByteToStr(bindata\Char);
  bindata := ReadBin(file);
ENDWHILE
```

Read the contents of a binary file `myfile.bin` from the beginning to the end and displays the received binary data converted to chars on the FlexPendant (one char on each line).

Limitations

The function can only be used for files and I/O devices that have been opened with read access (`\Read` for character based files, `\Bin` or `\Append \Bin` for binary files).

Syntax

```
ReadBin '('
  [IODevice ':='] <variable (VAR) of iodev>
  ['\' Time ':=' <expression (IN) of num>] ')'
```

A function with a return value of the type `num`.

Related information

For information about	See
Opening, etc. files or I/O devices	<i>Technical reference manual - RAPID Overview</i>
Convert a byte to a string data	ByteToStr - Converts a byte to a string data on page 1192
File and I/O device handling	<i>Application manual - Controller software IRC5</i>

2 Functions

2.152 ReadDir - Read next entry in a directory

RobotWare Base

2.152 ReadDir - Read next entry in a directory

Usage

`ReadDir` is used to retrieve the name of the next file or subdirectory under a directory that has been opened with the instruction `OpenDir`.

As long as the function returns `TRUE`, there can be more files or subdirectories to retrieve.

Basic examples

The following example illustrates the function `ReadDir`.

See also [More examples on page 1427](#).

Example 1

```
PROC lsdire(string dirname)
  VAR dir directory;
  VAR string filename;
  OpenDir directory, dirname;
  WHILE ReadDir(directory, filename) DO
    TPWrite filename;
  ENDWHILE
  CloseDir directory;
ENDPROC
```

This example prints out the names of all files or subdirectories under the specified directory.

Return value

Data type: `bool`

The function will return `TRUE` if it has retrieved a name, otherwise `FALSE`.

Arguments

`ReadDir (Dev FileName)`

Dev

Data type: `dir`

A variable with reference to the directory, fetched by instruction `OpenDir`.

FileName

Data type: `string`

The retrieved file or subdirectory name.

Program execution

This function returns a `bool` that specifies if the retrieving of a name was successful or not.

Continues on next page

Error handling

The following recoverable errors are generated and can be handled in an error handler. The system variable `ERRNO` will be set to:

Name	Cause of error
<code>ERR_FILEACC</code>	The directory is not opened (see <code>OpenDir</code>). The filename read consists of more bytes than the maximum length of a RAPID string. The string variable used in argument <code>FileName</code> will not be updated.

More examples

More examples of the function `ReadDir` are illustrated below

Example 1

This example implements a generic traverse of a directory structure function.

```

PROC searchdir(string dirname, string actionproc)
  VAR dir directory;
  VAR string filename;
  IF IsFile(dirname \Directory) THEN
    OpenDir directory, dirname;
    WHILE ReadDir(directory, filename) DO
      ! .. and . is the parent and resp. this directory
      IF filename <> ".." AND filename <> "." THEN
        searchdir dirname+"/"+filename, actionproc;
      ENDIF
    ENDWHILE
    CloseDir directory;
  ELSE
    %actionproc% dirname;
  ENDIF
ERROR
  RAISE;
ENDPROC

PROC listfile(string filename)
  TPWrite filename;
ENDPROC

PROC main()
  ! Execute the listfile routine for all files found under the
  ! tree in HOME:
  searchdir "HOME:", "listfile";
ENDPROC

```

This program traverses the directory structure under "HOME:", and for each file found it calls the `listfile` procedure. The `searchdir` is the generic part that knows nothing about the start of the search or which routine should be called for each file. It uses `IsFile` to check whether it has found a subdirectory or a file and it uses the late binding mechanism to call the procedure specified in `actionproc` for all files found. The `actionproc` routine should be a procedure with one parameter of the type `string`.

Continues on next page

2 Functions

2.152 ReadDir - Read next entry in a directory

RobotWare Base

Continued

Syntax

```
ReadDir '('  
  [ Dev ':' ] < variable (VAR) of dir> ','  
  [ FileName ':' ] < var or pers (INOUT) of string> ')'
```

A function with a return value of the data type `bool`.

Related information

For information about	See
Directory	dir - File directory structure on page 1648
Make a directory	MakeDir - Create a new directory on page 353
Open a directory	OpenDir - Open a directory on page 503
Close a directory	CloseDir - Close a directory on page 152
Remove a directory	RemoveDir - Delete a directory on page 602
Remove a file	RemoveFile - Delete a file on page 604
Rename a file	RenameFile - Rename a file on page 607
File and I/O device handling	Application manual - Controller software IRC5

2.153 ReadMotor - Reads the current motor angles

Usage

`ReadMotor` is used to read the current angles of the different motors of the robot and external axes. The primary use of this function is in the calibration procedure of the robot.

Basic examples

The following example illustrates the function `ReadMotor`.

See also [More examples on page 1430](#).

Example 1

```
VAR num motor_angle2;  
motor_angle2 := ReadMotor(2);
```

The current motor angle of the second axis of the robot is stored in `motor_angle2`.

Return value

Data type: num

The current motor angle in radians of the stated axis of the robot or external axes.

Arguments

```
ReadMotor [ \MecUnit ] Axis
```

MecUnit

Mechanical Unit

Data type: mecunit

The name of the mechanical unit for which an axis is to be read. If this argument is omitted, the axis for the connected robot is read.

Axis

Data type: num

The number of the axis to be read (1 - 6).

Program execution

The motor angle returned represents the current position in radians for the motor without any calibration offset. The value is not related to a fix position of the robot, only to the resolver internal zero position, that is, normally the resolver zero position closest to the calibration position (the difference between the resolver zero position and the calibration position is the calibration offset value). The value represents the full movement of each axis, although this may be several turns.

Error handling

The following recoverable errors are generated and can be handled in an error handler. The system variable `ERRNO` will be set to:

Name	Cause of error
<code>ERR_AXIS_PAR</code>	Parameter axis in function is wrong.

Continues on next page

2 Functions

2.153 ReadMotor - Reads the current motor angles

RobotWare Base

Continued

More examples

The following example illustrates the function `ReadMotor`.

Example 1

```
VAR num motor_angle;  
motor_angle := ReadMotor(\MecUnit:=STN1, 1);
```

The current motor angle of the first axis of `STN1` is stored in `motor_angle`.

Limitations

It is only possible to read the current motor angles for the mechanical units that are controlled from current program task. For a non-motion task, it is possible to read the angles for the mechanical units controlled by the connected motion task.

Syntax

```
ReadMotor '('  
  ['\' MecUnit ':= ' < variable (VAR) of mecunit> ',']  
  [Axis ':= ' ] < expression (IN) of num> ')'
```

A function with a return value of the data type `num`.

Related information

For information about	See
Reading the current joint angle	CJointT - Reads the current joint angles on page 1220

2.154 ReadNum - Reads a number from a file or I/O device

Usage

ReadNum (*Read Numeric*) is used to read a number from a character-based file or I/O device.

Basic examples

The following example illustrates the function ReadNum.

See also [More examples on page 1432](#).

Example 1

```
VAR iodev infile;
...
Open "HOME:/file.doc", infile\Read;
reg1 := ReadNum(infile);
```

reg1 is assigned a number read from the file file.doc.

Return value

Data type: num

The numeric value read from a specified file or I/O device. If the file is empty (end of file), a number greater than EOF_NUM (9.998E36) is returned.

Arguments

```
ReadNum (IODevice [\Delim] [\Time])
```

IODevice

Data type: iodev

The name (reference) of the file or I/O device to be read.

[\Delim]

Delimiters

Data type: string

A string containing the delimiters to use when parsing a line in the file or I/O device. By default (without \Delim), the file is read line by line and the line-feed character (\0A) is the only delimiter considered by the parsing. When the \Delim argument is used, any character in the specified string argument will be considered to determine the significant part of the line.

When using the argument \Delim, the control system always adds the characters carriage return (\0D) and line-feed (\0A) to the delimiters specified by the user.

To specify non-alphanumeric characters, use \xx, where xx is the hexadecimal representation of the ASCII code of the character (example: TAB is specified by \09).

[\Time]

Data type: num

Continues on next page

2 Functions

2.154 ReadNum - Reads a number from a file or I/O device

RobotWare Base

Continued

The max. time for the reading operation (timeout) in seconds. If this argument is not specified, the max. time is set to 60 seconds. To wait forever, use the predefined constant `WAIT_MAX`.

If this time runs out before the read operation is finished, the error handler will be called with the error code `ERR_DEV_MAXTIME`. If there is no error handler, the execution will be stopped.

The timeout function is also in use during program stop and will be noticed by the RAPID program at program start.

Program execution

Starting at the current file position, the function reads and discards any heading delimiters. A heading delimiter without the argument `\Delim` is a line-feed character. Heading delimiters with the argument `\Delim` are any characters specified in the `\Delim` argument plus carriage return and line-feed characters. It then reads everything up to and including the next delimiter character (will be discarded), but not more than 80 characters. If the significant part exceeds 80 characters, the remainder of the characters will be read on the next reading.

The string that is read is then converted to a numeric value; for example, "234.4" is converted to the numeric value 234.4.

At power fail restart, any open file or I/O device in the system will be closed and the I/O descriptor in the variable of type `iodev` will be reset.

Predefined data

The constant `EOF_NUM` can be used to stop reading, at the end of the file.

```
CONST num EOF_NUM := 9.998E36;
```

Error handling

The following recoverable errors are generated and can be handled in an error handler. The system variable `ERRNO` will be set to:

Name	Cause of error
<code>ERR_FILEACC</code>	An access error occurs during reading.
<code>ERR_RCVDATA</code>	There is an attempt to read non-numeric data.
<code>ERR_DEV_MAXTIME</code>	Time-out before the read operation is finished.

More examples

The following example illustrates the function `ReadNum`.

Example 1

```
reg1 := ReadNum(infile\Delim:="\09");  
IF reg1 > EOF_NUM THEN  
  TPWrite "The file is empty";  
  ...
```

Continues on next page

Reads a number in a line where numbers are separated by TAB ("`\09`") or SPACE ("") characters. Before using the number read from the file, a check is performed to make sure that the file is not empty.



Note

Use `<` or `>` (smaller than or greater than) when checking if the file is empty. Do not use `=` (equal to).

Limitations

The function can only be used for character based files that have been opened for reading.

Syntax

```
ReadNum '('  
  [IODevice ':='] <variable (VAR) of iodev>  
  ['\ ' Delim ':='] <expression (IN) of string>  
  ['\ ' Time ':='] <expression (IN) of num> ')''
```

A function with a return value of the type `num`.

Related information

For information about	See
Opening, etc. files or I/O devices	<i>Technical reference manual - RAPID Overview</i>
File and I/O device handling	<i>Application manual - Controller software IRC5</i>

2 Functions

2.155 ReadStr - Reads a string from a file or I/O device

RobotWare Base

2.155 ReadStr - Reads a string from a file or I/O device

Usage

`ReadStr` (*Read String*) is used to read a string from a character-based file or I/O device.

Basic examples

The following example illustrates the function `ReadStr`.

See also [More examples on page 1436](#).

Example 1

```
VAR string text;
VAR iodev infile;
...
Open "HOME:/file.doc", infile\Read;
text := ReadStr(infile);
```

`text` is assigned a string read from the file `file.doc`.

Return value

Data type: `string`

The string read from the specified file or I/O device. If the file is empty (end of file), the string "EOF" is returned.

Arguments

```
ReadStr (IODevice [\Delim] [\RemoveCR] [\DiscardHeaders] [\Time]
        [\Line])
```

`IODevice`

Data type: `iodev`

The name (reference) of the file or I/O device to be read.

`[\Delim]`

Delimiters

Data type: `string`

A string containing the delimiters to use when parsing a line in the file or I/O device. By default the file is read line by line and the line-feed character (`\0A`) is the only delimiter considered by the parsing. When the `\Delim` argument is used, any character in the specified string argument plus by default line-feed character will be considered to determine the significant part of the line.

To specify non-alphanumeric characters, use `\xx`, where `xx` is the hexadecimal representation of the ASCII code of the character (example: TAB is specified by `\09`).

`[\RemoveCR]`

Data type: `switch`

A switch used to remove the trailing carriage return character when reading PC files. In PC files, a new line is specified by carriage return and line feed (CRLF).

Continues on next page

When reading a line in such files, the carriage return character is by default read into the return string. When using this argument, the carriage return character will be read from the file but not included in the return string.

[`\DiscardHeaders`]

Data type: `switch`

This argument specifies whether the heading delimiters (specified in `\Delim` plus default line-feed) are skipped or not before transferring data to the return string. By default, if the first character at the current file position is a delimiter, it is read but not transferred to the return string, the line parsing is stopped and the return will be an empty string. If this argument is used, all delimiters included in the line will be read from the file but discarded, and no return will be done until the return string will contain the data starting at the first non-delimiter character in the line.

[`\Time`]

Data type: `num`

The max. time for the reading operation (timeout) in seconds. If this argument is not specified, the max. time is set to 60 seconds. To wait forever, use the predefined constant `WAIT_MAX`.

If this time runs out before the read operation is finished, the error handler will be called with the error code `ERR_DEV_MAXTIME`. If there is no error handler, the execution will be stopped.

The timeout function is in use also during program stop and will be noticed in the RAPID program at program start.

[`\Line`]

Data type: `num`

Specifies which line in the file that should be read.

If the line does not exist, the string "EOF" is returned.

Program execution

Starting at the current file position, if the `\DiscardHeaders` argument is used, the function reads and discards any heading delimiters (line-feed characters and any character specified in the `\Delim` argument). In all cases, it then reads everything up to the next delimiter character, but not more than 80 characters. If the significant part exceeds 80 characters, the remainder of the characters will be read on the next reading. The delimiter that caused the parsing to stop is read from the file but not transferred to the return string. If the last character in the string is a carriage return character and the `\RemoveCR` argument is used, this character will be removed from the string.

At power fail restart, any open file or I/O device in the system will be closed and the I/O descriptor in the variable of type `iodev` will be reset.

Predefined data

The constant `EOF` can be used to check if the file was empty when trying to read from the file or to stop reading at the end of the file.

```
CONST string EOF := "EOF";
```

Continues on next page

2 Functions

2.155 ReadStr - Reads a string from a file or I/O device

RobotWare Base

Continued

Error handling

The following recoverable errors are generated and can be handled in an error handler. The system variable `ERRNO` will be set to:

Name	Cause of error
<code>ERR_FILEACC</code>	An error occurs during reading.
<code>ERR_DEV_MAXTIME</code>	Time-out before the read operation is finished.

More examples

The following examples illustrate the function `ReadStr`.

Example 1

```
text := ReadStr(infile);
IF text = EOF THEN
  TPWrite "The file is empty";
  ...
```

Before using the string read from the file, a check is performed to make sure that the file is not empty.

Example 2

Consider a file containing:

```
<LF><SPACE><TAB>Hello<SPACE><SPACE>World<CR><LF>
text := ReadStr(infile);
```

text will be an empty string: the first character in the file is the default <LF> delimiter.

```
text := ReadStr(infile\DiscardHeaders);
```

text will contain <SPACE><TAB>Hello<SPACE><SPACE>World<CR>: the first character in the file, the default <LF> delimiter, is discarded.

```
text := ReadStr(infile\RemoveCR\DiscardHeaders);
```

text will contain <SPACE><TAB>Hello<SPACE><SPACE>World: the first character in the file, the default <LF> delimiter, is discarded; the final carriage return character is removed

```
text := ReadStr(infile\Delim:=" \09"\RemoveCR\DiscardHeaders);
```

text will contain "Hello": the first characters in the file that match either the default <LF> delimiter or the character set defined by \Delim (space and tab) are discarded. Data is then transferred up to the first delimiter that is read from the file but not transferred into the string. A new invocation of the same statement will return "World".

Example 3

Consider a file containing:

```
<CR><LF>Hello<CR><LF>
text := ReadStr(infile);
```

text will contain the <CR> (\0d) character: <CR> and <LF> characters are read from the file, but only <CR> is transferred to the string. A new invocation of the same statement will return "Hello\0d".

```
text := ReadStr(infile\RemoveCR);
```

Continues on next page

text will contain an empty string: <CR> and <LF> characters are read from the file; <CR> is transferred but removed from the string. A new invocation of the same statement will return "Hello".

```
text := ReadStr(infile\Delim:="\0d");
```

text will contain an empty string: <CR> is read from the file but not transferred to the return string. A new invocation of the same instruction will return an empty string again: <LF> is read from the file but not transferred to the return string.

```
text := ReadStr(infile\Delim:="\0d"\DiscardHeaders);
```

text will contain "Hello". A new invocation of the same instruction will return "EOF" (end of file).

Limitations

The function can only be used for files or I/O devices that have been opened for reading in a character-based mode.

Syntax

```
ReadStr '('
  [IODevice ':='] <variable (VAR) of iodev>
  ['\ ' Delim ':='] <expression (IN) of string>]
  ['\ ' RemoveCR]
  ['\ ' DiscardHeaders]
  ['\ ' Time ':='] <expression (IN) of num>]
  ['\ ' Line ':='] <expression (IN) of num>] ')'
```

A function with a return value of the type string.

Related information

For information about	See
Opening, etc. files or I/O devices	<i>Technical reference manual - RAPID Overview</i>
File and I/O device handling	<i>Application manual - Controller software IRC5</i>

2 Functions

2.156 ReadStrBin - Reads a string from a binary I/O device or file

RobotWare Base

2.156 ReadStrBin - Reads a string from a binary I/O device or file

Usage

ReadStrBin (*Read String Binary*) is used to read a string from a binary I/O device or file.

Basic examples

The following example illustrates the function ReadStrBin.

Example 1

```
VAR iodev file1;
VAR string text;
...
Open "HOME:", \File:= "FILE1.DOC", file1 \Read \Bin;
text := ReadStrBin (file1, 10);
IF text = EOF THEN
```

The variable `text` is assigned a 10 characters text string read from the file `file1`. Before using the string read from the file, a check is performed to make sure that the file is not empty.

Return value

Data type: `string`

The text string read from the specified I/O device or file. If the file is empty (end of file), the string "EOF" is returned.

Arguments

```
ReadStrBin (IODevice NoOfChars [\Time])
```

`IODevice`

Data type: `iodev`

The name (reference) of the binary I/O device or file to be read.

`NoOfChars`

Number of Characters

Data type: `num`

The number of characters to be read from the binary I/O device or file.

`[\Time]`

Data type: `num`

The max. time for the reading operation (timeout) in seconds. If this argument is not specified, the max. time is set to 60 seconds. To wait forever, use the predefined constant `WAIT_MAX`.

If this time runs out before the read operation is finished, the error handler will be called with the error code `ERR_DEV_MAXTIME`. If there is no error handler, the execution will be stopped.

The timeout function is in use also during program stop and will be noticed by the RAPID program at program start.

Continues on next page

Program execution

The function reads the specified number of characters from the binary I/O device or file.

At power fail restart, any open file or I/O device in the system will be closed and the I/O descriptor in the variable of type `iodev` will be reset.

Predefined data

The constant `EOF` can be used to check if the file was empty, when trying to read from the file or to stop reading at the end of the file.

```
CONST string EOF := "EOF";
```

Error handling

The following recoverable errors are generated and can be handled in an error handler. The system variable `ERRNO` will be set to:

Name	Cause of error
<code>ERR_FILEACC</code>	An error occurs during reading.
<code>ERR_DEV_MAXTIME</code>	Time-out before the read operation is finished.

Limitations

The function can only be used for I/O devices or files that have been opened for reading in a binary mode.

Syntax

```
ReadStrBin '('
  [IODevice ':='] <variable (VAR) of iodev> ','
  [NoOfChars ':='] <expression (IN) of num>
  ['\ ' Time ':=' <expression (IN) of num>] ')''
```

A function with a return value of the type `string`.

Related information

For information about	See
Opening, etc. I/O devices or files	<i>Technical reference manual - RAPID Overview</i>
Write binary string	WriteStrBin - Writes a string to a binary I/O device on page 1110
File and I/O device handling	<i>Application manual - Controller software IRC5</i>

2 Functions

2.157 ReadVar - Read variable from a device *Sensor Interface*

2.157 ReadVar - Read variable from a device

Usage

`ReadVar` is used to read a variable from a device connected to the sensor interface.

Configuration example

This is an example of a sensor channel configuration.

These parameters belong to the type *Transmission Protocol* in the topic *Communication*.

Name	Type	Remote Address	Remote Port
sen1:	SOCKDEV	192.168.125.101	6344

Basic examples

The following example illustrates the function `ReadVar`.

Example 1

```
CONST num XCoord := 8;
CONST num YCoord := 9;
CONST num ZCoord := 10;

VAR pos SensorPos;

! Connect to the sensor device "sen1:" (defined in sio.cfg)
SenDevice "sen1:";

! Read a cartesian position from the sensor.

SensorPos.x := ReadVar ("sen1:", XCoord);
SensorPos.y := ReadVar ("sen1:", YCoord);
SensorPos.z := ReadVar ("sen1:", ZCoord);
```

Arguments

```
ReadVar (device, VarNo, [\TaskName])
```

device

Data type: string

The I/O device name configured in `sio.cfg` for the sensor used.

VarNo

Data type: num

The argument `VarNo` is used to select variable to be read.

[\TaskName]

Data type: string

The argument `TaskName` makes it possible to access devices in other RAPID tasks.

Continues on next page

Error handling

The following recoverable errors are generated and can be handled in an error handler. The system variable `ERRNO` will be set to:

Name	Cause of error
SEN_NO_MEAS	Measurement failure
SEN_NOREADY	Sensor unable to handle command
SEN_GENERRO	General sensor error
SEN_BUSY	Sensor busy
SEN_UNKNOWN	Unknown sensor
SEN_EXALARM	External sensor error
SEN_CAALARM	Internal sensor error
SEN_TEMP	Sensor temperature error
SEN_VALUE	Illegal communication value
SEN_CAMCHECK	Sensor check failure
SEN_TIMEOUT	Communication error

Syntax

```
ReadVar '('
  [device ':=' ] <expression(IN) of string> ','
  [VarNo ':=' ] <expression (IN) of num> ','
  ['\' TaskName ':=' <expression (IN) of string> ] ')'
```

A function with a return value of the data type `num`.

Related information

For information about	See
Connect to a sensor device	SenDevice - connect to a sensor device on page 688
Write a sensor variable	WriteVar - Write variable on page 1112
Write a sensor data block	WriteBlock - Write block of data to device on page 1102
Read a sensor data block	ReadBlock - read a block of data from device on page 584
Configuration of sensor communication	<i>Technical reference manual - RAPID Overview</i>

2 Functions

2.158 RelTool - Make a displacement relative to the tool

RobotWare Base

2.158 RelTool - Make a displacement relative to the tool

Usage

RelTool (*Relative Tool*) is used to add a displacement and/or a rotation, expressed in the active tool coordinate system, to a robot position.

Basic examples

The following examples illustrate the function RelTool.

Example 1

```
MoveL RelTool (p1, 0, 0, 100), v100, fine, tool1;
```

The robot is moved to a position that is 100 mm from p1 in the z direction of the tool.

Example 2

```
MoveL RelTool (p1, 0, 0, 0 \Rz:= 25), v100, fine, tool1;
```

The tool is rotated 25° around its z-axis.

Return value

Data type: robtarget

The new position with the addition of a displacement and/or a rotation, if any, relative to the active tool.

Arguments

```
RelTool (Point Dx Dy Dz [\Rx] [\Ry] [\Rz])
```



Note

The rotations will be performed in the following order if two or three rotations are specified at the same time:

- 1 rotation around the x axis
- 2 rotation around the new y axis
- 3 rotation around the new z axis

Point

Data type: robtarget

The input robot position. The orientation part of this position defines the current orientation of the tool coordinate system.

Dx

Data type: num

The displacement in mm in the x direction of the tool coordinate system.

Dy

Data type: num

The displacement in mm in the y direction of the tool coordinate system.

Continues on next page

Dz

Data type: num

The displacement in mm in the z direction of the tool coordinate system.

[\Rx]

Data type: num

The rotation in degrees around the x axis of the tool coordinate system.

[\Ry]

Data type: num

The rotation in degrees around the y axis of the tool coordinate system.

[\Rz]

Data type: num

The rotation in degrees around the z axis of the tool coordinate system.

Syntax

```

RelTool '('
  [ Point ':=' ] < expression (IN) of rotarget> ','
  [ Dx ':=' ] <expression (IN) of num> ','
  [ Dy ':=' ] <expression (IN) of num> ','
  [ Dz ':=' ] <expression (IN) of num>
  [ '\ ' Rx ':=' <expression (IN) of num> ]
  [ '\ ' Ry ':=' <expression (IN) of num> ]
  [ '\ ' Rz ':=' <expression (IN) of num> ] ')'

```

A function with a return value of the data type rotarget.

Related information

For information about	See
Position data	rotarget - Position data on page 1734
Mathematical instructions and functions	<i>Technical reference manual - RAPID Overview</i>
Positioning instructions	<i>Technical reference manual - RAPID Overview</i>

2 Functions

2.159 RemainingRetries - Remaining retries left to do *RobotWare Base*

2.159 RemainingRetries - Remaining retries left to do

Usage

`RemainingRetries` is used to find out how many `RETRY` that is left to do from the error handler in the program. The maximum number of retries is defined in the configuration.

Basic examples

The following example illustrates the function `RemainingRetries`.

Example 1

```
...
ERROR
  IF RemainingRetries() > 0 THEN
    RETRY;
  ELSE
    TRYNEXT;
  ENDF
...
```

This program will retry the instruction, in spite of the error, until the maximum number of retries is done and then try the next instruction.

Return value

Data type: `num`

The return value shows how many of the maximum number of retries that is left to do.

Syntax

```
RemainingRetries '(' ' ')
```

A function with a return value of the data type `num`.

Related information

For information about	See
Error handlers	<i>Technical reference manual - RAPID Overview</i>
Resume execution after an error	RETRY - Resume execution after an error on page 620
Configure maximum number of retries	<i>Technical reference manual - System parameters, section General RAPID</i>
Reset the number of retries counted	ResetRetryCount - Reset the number of retries on page 616

2.160 RMQGetSlotName - Get the name of an RMQ client *FlexPendant Interface, PC Interface, or Multitasking*

2.160 RMQGetSlotName - Get the name of an RMQ client

Usage

`RMQGetSlotName` (*RAPID Mesasage Queue Get Slot Name*) is used to get the slot name of an RMQ or an SDK client from a given slot identity - that is, from a given `rmqslot`.

Basic examples

The following example illustrates the function `RMQGetSlotName`.

Example 1

```
VAR rmqslot slot;
VAR string client_name;
RMQFindSlot slot, "RMQ_T_ROB1";
...
client_name := RMQGetSlotName(slot);
TPWrite "Name of the client: " + client_name;
```

The example illustrates how to get the name of a client using the identity of the client.

Return value

Data type: `string`

The name of the client is returned. This can be an RMQ name, or the name of a Robot Application Builder client using the RMQ functionality.

Arguments

`RMQGetSlotName (Slot)`

Slot

Data type: `rmqslot`

The identity slot number of the client to find the name.

Program execution

The instruction `RMQGetSlotName` is used to find the name of the client with the specified identity number specified in argument `Slot`. The client can be another RMQ, or an SDK client.

Error handling

The following recoverable errors are generated and can be handled in an error handler. The system variable `ERRNO` will be set to:

Name	Cause of error
<code>ERR_RMQ_INVALID</code>	The destination slot has not been connected or the destination slot is no longer available. If not connected, a call to <code>RMQFindSlot</code> must be done. If not available, the reason is that a remote client has been disconnected from the controller.

Continues on next page

2 Functions

2.160 RMQGetSlotName - Get the name of an RMQ client

FlexPendant Interface, PC Interface, or Multitasking

Continued

Syntax

```
RMQGetSlotName '('  
    [ Slot ':=' ] < variable (VAR) of rmqslot > ')'
```

A function with a return value of the data type `string`.

Related information

For information about	See
Description of the RAPID Message Queue functionality	<i>Application manual - Controller software IRC5, section RAPID Message Queue.</i>
Find the identity number of a RAPID Message Queue task or SDK client	RMQFindSlot - Find a slot identity from the slot name on page 626
Send data to the queue of a RAPID task or SDK client	RMQSendMessage - Send an RMQ data message on page 640
Get the first message from a RAPID Message Queue.	RMQGetMessage - Get an RMQ message on page 628
Send data to the queue of a RAPID task or an SDK client, and wait for an answer from the client	RMQSendWait - Send an RMQ data message and wait for a response on page 644
Extract the header data from an <code>rmqmessage</code>	RMQGetMsgHeader - Get header information from an RMQ message on page 634
Extract the data from an <code>rmqmessage</code>	RMQGetMsgData - Get the data part from an RMQ message on page 631
Order and enable interrupts for a specific data type	IRMQMessage - Orders RMQ interrupts for a data type on page 301
RMQ Slot	rmqslot - Identity number of an RMQ client on page 1732

2.161 RobName - Get the TCP robot name

Usage

RobName (*Robot Name*) is used to get the name of the TCP robot in some program task. If the task doesn't control any TCP robot, this function returns an empty string.

Basic examples

The following example illustrates the function RobName.

See also [More examples on page 1447](#).

Example 1

```
VAR string my_robot;  
...  
my_robot := RobName();  
IF my_robot="" THEN  
    TPWrite "This task does not control any TCP robot";  
ELSE  
    TPWrite "This task controls TCP robot with name "+ my_robot;  
ENDIF
```

Write to FlexPendant the name of the TCP robot which is controlled from this program task. If no TCP robot is controlled, write that the task controls no robot.

Return value

Data type: string

The mechanical unit name for the TCP robot that is controlled from this program task. Return empty string if no TCP robot is controlled.

More examples

More examples of how to use the instruction RobName are illustrated below.

Example 1

```
VAR string my_robot;  
...  
IF TaskRunRob() THEN  
    my_robot := RobName();  
    TPWrite "This task controls robot with name "+ my_robot;  
ENDIF
```

If this program task controls any TCP robot, write to FlexPendant the name of that TCP robot.

Syntax

```
RobName '(' ' ' )'
```

A function with a return value of the data type string.

Continues on next page

2 Functions

2.161 RobName - Get the TCP robot name

RobotWare Base

Continued

Related information

For information about	See
Check if task run some TCP robot	TaskRunRob - Check if task controls some robot on page 1507
Check if task run some mechanical unit	TaskRunMec - Check if task controls any mechanical unit on page 1506
Get the name of mechanical units in the system	GetNextMechUnit - Get name and data for mechanical units on page 1295
String functions	<i>Technical reference manual - RAPID Instructions, Functions and Data types</i>
Definition of string	string - Strings on page 1761

2.162 RobOS - Check if execution is on RC or VC

Usage

RobOS (*Robot Operating System*) can be used to check if the execution is performed on Robot Controller RC or Virtual Controller VC.

Basic examples

The following example illustrates the function RobOS.

Example 1

```
IF RobOS() THEN
  ! Execution statements in RC
ELSE
  ! Execution statements in VC
ENDIF
```

Return value

Data type: bool

TRUE if execution runs on Robot Controller RC, FALSE otherwise.

Syntax

```
RobOS '(' '')
```

A function with a return value of the data type bool.

2 Functions

2.163 Round - Round a numeric value

RobotWare Base

2.163 Round - Round a numeric value

Usage

Round is used to round a numeric value to a specified number of decimals or to an integer value.

Basic examples

The following examples illustrate the function Round.

Example 1

```
VAR num val;  
val := Round(0.3852138\Dec:=3);
```

The variable `val` is given the value 0.385.

Example 2

```
val := Round(0.3852138\Dec:=1);
```

The variable `val` is given the value 0.4.

Example 3

```
val := Round(0.3852138);
```

The variable `val` is given the value 0.

Example 4

```
val := Round(0.3852138\Dec:=6);
```

The variable `val` is given the value 0.385214.

Return value

Data type: num

The numeric value rounded to the specified number of decimals.

Arguments

```
Round ( Val [\Dec])
```

Val

Value

Data type: num

The numeric value to be rounded.

[\Dec]

Decimals

Data type: num

Number of decimals.

If the specified number of decimals is 0 or if the argument is omitted, the value is rounded to an integer.

The number of decimals must not be negative or greater than the available precision for numeric values.

Max number of decimals that can be used is 6.

Continues on next page

Syntax

```
Round '('  
  [ Val ':=' ] <expression (IN) of num>  
  [ \Dec ':=' <expression (IN) of num> ] ')'
```

A function with a return value of the data type num.

Related information

For information about	See
Mathematical instructions and functions	<i>Technical reference manual - RAPID Overview</i>
Truncating a value	Trunc - Truncates a numeric value on page 1530

2 Functions

2.164 RoundDnum - Round a numeric value

RobotWare Base

2.164 RoundDnum - Round a numeric value

Usage

RoundDnum is used to round a numeric value to a specified number of decimals or to an integer value.

Basic examples

The following examples illustrate the function RoundDnum.

Example 1

```
VAR dnum val;  
val := RoundDnum(0.3852138754655357\Dec:=3);
```

The variable `val` is given the value 0.385.

Example 2

```
val := RoundDnum(0.3852138754655357\Dec:=1);
```

The variable `val` is given the value 0.4.

Example 3

```
val := RoundDnum(0.3852138754655357);
```

The variable `val` is given the value 0.

Example 4

```
val := RoundDnum(0.3852138754655357\Dec:=15);
```

The variable `val` is given the value 0.385213875465536.

Example 5

```
val := RoundDnum(1000.3852138754655357\Dec:=15);
```

The variable `val` is given the value 1000.38521387547.

Return value

Data type: `dnum`

The numeric value rounded to the specified number of decimals.

Arguments

```
RoundDnum ( Val [\Dec] )
```

`Val`

Value

Data type: `dnum`

The numeric value to be rounded.

`[\Dec]`

Decimals

Data type: `num`

Number of decimals.

If the specified number of decimals is 0 or if the argument is omitted, the value is rounded to an integer.

Continues on next page

The number of decimals must not be negative or greater than the available precision for numeric values.

Max number of decimals that can be used is 15.

Syntax

```
RoundDnum '('
  [ Val ':=' ] <expression (IN) of dnum>
  [ \Dec ':=' <expression (IN) of num> ] ')'
```

A function with a return value of the data type dnum.

Related information

For information about	See
Mathematical instructions and functions	<i>Technical reference manual - RAPID Overview</i>
Rounding a value	Round - Round a numeric value on page 1450
Truncating a value	Trunc - Truncates a numeric value on page 1530
Truncating a value	TruncDnum - Truncates a numeric value on page 1532

2 Functions

2.165 RunMode - Read the running mode

RobotWare Base

2.165 RunMode - Read the running mode

Usage

RunMode (*Running Mode*) is used to read the current running mode of the program task.

Basic examples

The following example illustrates the function RunMode.

Example 1

```
IF RunMode() = RUN_CONT_CYCLE THEN
...
ENDIF
```

The program section is executed only for continuous or cycle running.

Return value

Data type: symnum

The current running mode is defined as described in the table below.

Return value	Symbolic constant	Comment
0	RUN_UNDEF	Undefined running mode
1	RUN_CONT_CYCLE	Continuous or cycle running mode
2	RUN_INSTR_FWD	Instruction forward running mode
3	RUN_INSTR_BWD	Instruction backward running mode
4	RUN_SIM	Simulated running mode. Not yet released.
5	RUN_STEP_MOVE	Move instructions in forward running mode and logical instructions in continuous running mode

Arguments

```
RunMode ( [ \Main ] )
```

[\Main]

Data type: switch

Return current mode for the task if it is a motion task. If used in a non-motion task, it will return the current mode of the motion task that the non-motion task is connected to.

If this argument is omitted, the return value always mirrors the current running mode for the program task which executes the function RunMode.

Syntax

```
RunMode '('
        ['\ Main'] ')'
```

A function with a return value of the data type symnum.

Continues on next page

Related information

For information about	See
Reading operating mode	OpMode - Read the operating mode on page 1383

2 Functions

2.166 `SafetyControllerGetChecksum` - Get the checksum for the user configuration file
SafeMove Basic, SafeMove Pro, PROFIsafe

2.166 `SafetyControllerGetChecksum` - Get the checksum for the user configuration file

Usage

`SafetyControllerGetChecksum` is used to get the safety controller checksum for the user configuration file.

Basic examples

The following example illustrates the function `SafetyControllerGetChecksum`.

Example 1

```
VAR string mystring;  
...  
mystring:=SafetyControllerGetChecksum();
```

Get the checksum for the user configuration file and store it in the variable `mystring`.

Return value

Data type: `string`

The checksum for the user configuration.

Syntax

```
SafetyControllerGetChecksum '(' '')
```

A function with a return value of the data type `string`.

Related information

For information about	See
<code>SafetyControllerGetOpModePinCode</code>	SafetyControllerGetOpModePinCode - Get the operating mode pin code on page 1457
<code>SafetyControllerGetUserChecksum</code>	SafetyControllerGetUserChecksum - Get the checksum for protected parameters on page 1459
<code>SafetyControllerGetSWVersion</code>	SafetyControllerGetSWVersion - Get the safety controller firmware version on page 1458
<code>SafetyControllerSyncRequest</code>	SafetyControllerSyncRequest - Initiation of hardware synchronization procedure on page 649

2.167 SafetyControllerGetOpModePinCode - Get the operating mode pin code *SafeMove Basic, SafeMove Pro, PROFIsafe*

2.167 SafetyControllerGetOpModePinCode - Get the operating mode pin code

Usage

`SafetyControllerGetOpModePinCode` is used to get the operating mode pin code for the keyless mode selector.

Basic examples

The following example illustrates the function `SafetyControllerGetOpModePinCode`.

Example 1

```
VAR string mystring;
...
mystring:=SafetyControllerGetOpModePinCode();
```

Get the operating mode pin code for the for the keyless mode selector and store it in the variable `mystring`.

Return value

Data type: `string`

The pin code for the for the keyless mode selector.

Syntax

```
SafetyControllerGetOpModePinCode '(' '')
```

A function with a return value of the data type `string`.

Related information

For information about	See
<code>SafetyControllerGetChecksum</code>	SafetyControllerGetChecksum - Get the checksum for the user configuration file on page 1456
<code>SafetyControllerGetUserChecksum</code>	SafetyControllerGetUserChecksum - Get the checksum for protected parameters on page 1459
<code>SafetyControllerGetSWVersion</code>	SafetyControllerGetSWVersion - Get the safety controller firmware version on page 1458
<code>SafetyControllerSyncRequest</code>	SafetyControllerSyncRequest - Initiation of hardware synchronization procedure on page 649

2 Functions

2.168 SafetyControllerGetSWVersion - Get the safety controller firmware version
SafeMove Basic, SafeMove Pro, PROFIsafe

2.168 SafetyControllerGetSWVersion - Get the safety controller firmware version

Usage

`SafetyControllerGetSWVersion` is used to get the safety controller firmware version.

Basic examples

The following example illustrates the function `SafetyControllerGetSWVersion`.

Example 1

```
VAR string mystring;  
...  
mystring:=SafetyControllerGetSWVersion();
```

Get the safety controller firmware version and store it in the variable `mystring`.

Return value

Data type: `string`

The safety controller firmware version. A string with "VC" is returned if this function is used on the Virtual Controller.

Syntax

```
SafetyControllerGetSWVersion (' ' '')
```

A function with a return value of the data type `string`.

Related information

For information about	See
<code>SafetyControllerGetOpModePinCode</code>	SafetyControllerGetOpModePinCode - Get the operating mode pin code on page 1457
<code>SafetyControllerGetUserChecksum</code>	SafetyControllerGetUserChecksum - Get the checksum for protected parameters on page 1459
<code>SafetyControllerGetSWVersion</code>	SafetyControllerGetSWVersion - Get the safety controller firmware version on page 1458
<code>SafetyControllerSyncRequest</code>	SafetyControllerSyncRequest - Initiation of hardware synchronization procedure on page 649

2.169 SafetyControllerGetUserChecksum - Get the checksum for protected parameters
SafeMove Basic, SafeMove Pro, PROFIsafe

2.169 SafetyControllerGetUserChecksum - Get the checksum for protected parameters

Usage

`SafetyControllerGetUserChecksum` is used to get the safety controller checksum for the area with protected parameters in the user configuration file.

Basic examples

The following example illustrates the function `SafetyControllerGetUserChecksum`.

Example 1

```
VAR string mystring;
...
mystring:=SafetyControllerGetUserChecksum();
```

Get the checksum for the area with protected parameters in the user configuration file and store it in the variable `mystring`.

Return value

Data type: `string`

The checksum for the area with protected parameters.

Syntax

```
SafetyControllerGetUserChecksum '(' '')
```

A function with a return value of the data type `string`.

Related information

For information about	See
<code>SafetyControllerGetOpModePinCode</code>	SafetyControllerGetOpModePinCode - Get the operating mode pin code on page 1457
<code>SafetyControllerGetChecksum</code>	SafetyControllerGetChecksum - Get the checksum for the user configuration file on page 1456
<code>SafetyControllerGetSWVersion</code>	SafetyControllerGetSWVersion - Get the safety controller firmware version on page 1458
<code>SafetyControllerSyncRequest</code>	SafetyControllerSyncRequest - Initiation of hardware synchronization procedure on page 649

2 Functions

2.170 Sin - Calculates the sine value

RobotWare Base

2.170 Sin - Calculates the sine value

Usage

`Sin(Sine)` is used to calculate the sine value from an angle value.

Basic examples

The following example illustrates the function `Sin`.

Example 1

```
VAR num angle;  
VAR num value;  
...  
...  
value := Sin(angle);  
value will get the sine value of angle.
```

Return value

Data type: num
The sine value, range [-1, 1].

Arguments

`Sin (Angle)`

Angle

Data type: num
The angle value, expressed in degrees.

Syntax

```
Sin '('  
  [Angle ':='] <expression (IN) of num> ')'
```

A function with a return value of the data type `num`.

Related information

For information about	See
Mathematical instructions and functions	<i>Technical reference manual - RAPID Overview</i>

2.171 SinDnum - Calculates the sine value

Usage

SinDnum (*Sine dnum*) is used to calculate the sine value from an angle value on data types dnum.

Basic examples

The following example illustrates the function SinDnum.

Example 1

```
VAR dnum angle;
VAR dnum value;
...
...
value := SinDnum(angle);
value will get the sine value of angle.
```

Return value

Data type: dnum

The sine value, range [-1, 1] .

Arguments

SinDnum (Angle)

Angle

Data type: dnum

The angle value, expressed in degrees.

Syntax

```
SinDnum '('
  [Angle ':='] <expression (IN) of dnum> ')'
```

A function with a return value of the data type dnum.

Related information

For information about	See
Mathematical instructions and functions	<i>Technical reference manual - RAPID Overview</i>

2 Functions

2.172 SocketGetStatus - Get current socket state

Socket Messaging

2.172 SocketGetStatus - Get current socket state

Usage

`SocketGetStatus` returns the current state of a socket.

Basic examples

The following example illustrates the function `SocketGetStatus`.

See also [More examples on page 1462](#).

Example 1

```
VAR socketdev socket1;  
VAR socketstatus state;  
...  
SocketCreate socket1;  
state := SocketGetStatus( socket1 );
```

The socket status `SOCKET_CREATED` will be stored in the variable `state`.

Return value

Data type: `socketstatus`

The current state of the socket.

Only the predefined symbolic constants of type `socketstatus` can be used to check the state.

Arguments

```
SocketGetStatus( Socket )
```

Socket

Data type: `socketdev`

The socket variable which state is of interest.

Program execution

The function returns one of the following predefined states of `socketstatus`:

`SOCKET_CREATED`, `SOCKET_CONNECTED`, `SOCKET_BOUND`, `SOCKET_LISTENING`
or `SOCKET_CLOSED`.

More examples

The following example illustrates the function `SocketGetStatus`.

Example 1

```
VAR socketstatus status;  
VAR socketdev my_socket;  
...  
SocketCreate my_socket;  
SocketConnect my_socket, "192.168.0.1", 1025;  
! A lot of RAPID code  
status := SocketGetStatus( my_socket );  
!Check which instruction that was executed last, not the state of  
!the socket
```

Continues on next page

```

IF status = SOCKET_CREATED THEN
  TPWrite "Instruction SocketCreate has been executed";
ELSEIF status = SOCKET_CLOSED THEN
  TPWrite "Instruction SocketClose has been executed";
ELSEIF status = SOCKET_BOUND THEN
  TPWrite "Instruction SocketBind has been executed";
ELSEIF status = SOCKET_LISTENING THEN
  TPWrite "Instruction SocketListen or SocketAccept has been
    executed";
ELSEIF status = SOCKET_CONNECTED THEN
  TPWrite "Instruction SocketConnect, SocketReceive or SocketSend
    has been executed";
ELSE
  TPWrite "Unknown socket status";
ENDIF

```

A client socket is created and connected to a remote computer. Before the socket is used in a `SocketSend` instruction the state of the socket is checked so that it is still connected.

Limitations

The state of a socket can only be changed by executing RAPID socket instruction. For example, if the socket is connected and later the connection is broken, this will not be reported by the `SocketGetStatus` function. Instead there will be an error returned when the socket is used in a `SocketSend` or `SocketReceive` instruction.

Syntax

```

SocketGetStatus '('
  [Socket ':='] <variable (VAR) of socketdev>')'

```

A function with a return value of the data type `socketstatus`.

Related information

For information about	See
Socket communication in general	Application manual - Controller software IRC5
Create a new socket	SocketCreate - Create a new socket on page 745
Connect to remote computer (only client)	SocketConnect - Connect to a remote computer on page 742
Send data to remote computer	SocketSend - Send data to remote computer on page 759
Receive data from remote computer	SocketReceive - Receive data from remote computer on page 749
Close the socket	SocketClose - Close a socket on page 740
Bind a socket (only server)	SocketBind - Bind a socket to my IP-address and port on page 738
Listening connections (only server)	SocketListen - Listen for incoming connections on page 747

Continues on next page

2 Functions

2.172 SocketGetStatus - Get current socket state

Socket Messaging

Continued

For information about	See
Accept connections (only server)	SocketAccept - Accept an incoming connection on page 735

2.173 SocketPeek - Test for the presence of data on a socket

Usage

`SocketPeek` is used to test for the presence of data on a socket. It returns the number of bytes that can be received on the specified socket.

Basic examples

The following example illustrates the function `SocketPeek`.

Example 1

```

VAR socketdev socket1;
VAR socketdev client_socket;
VAR num peek_value;
...
SocketCreate socket1;
SocketBind socket1, "192.168.0.1", 1025;
SocketListen socket1;
SocketAccept socket1, client_socket;
..
peek_value := SocketPeek( client_socket );
IF peek_value >= 64 THEN
    SocketReceive client_socket \Str := str_data \ReadNoOfBytes:=64;
..
ELSE
    ! Not enough data to receive. Do something else.
ENDIF

```

First a server socket is created and bound to port 1025 on the controller network address 192.168.0.1. Then `SocketPeek` is used to check if there are 64 bytes of data available to receive on the socket.

Return value

Data type: num

The number of bytes available on a specific socket.

Arguments

`SocketPeek (Socket)`

Socket

Data type: socketdev

The socket variable which should be peeked.

Error handling

The following recoverable errors are generated and can be handled in an error handler. The system variable `ERRNO` will be set to:

Name	Cause of error
<code>ERR_SOCK_CLOSED</code>	The socket is closed. Broken connection.

Continues on next page

2 Functions

2.173 SocketPeek - Test for the presence of data on a socket

Socket Messaging

Continued

Name	Cause of error
ERR_SOCKET_EXEC_LEVEL	Use of socket instructions on different RAPID execution levels at the same time, that is, normal execution level and TRAP level.
ERR_SOCKET_NOT_BOUND	The socket has not been bound to an address. When using the type datagram protocol UDP/IP.
ERR_SOCKET_NOT_CONN	The socket is not connected

Limitations

All sockets are closed after power fail restart. This problem can be handled by error recovery.

The maximum size of data that can be received in one call is limited to 1024 bytes. Therefore the max value that can be returned from `SocketPeek` is 1024.

Syntax

```
SocketPeek '('  
    [Socket ':='] <variable (VAR) of socketdev>')'
```

A function with a return value of the data type `num`.

Related information

For information about	See
Socket communication in general	<i>Application manual - Controller software IRC5</i>
Create a new socket	SocketCreate - Create a new socket on page 745
Connect to remote computer (only client)	SocketConnect - Connect to a remote computer on page 742
Send data to remote computer	SocketSend - Send data to remote computer on page 759
Send data to remote computer	SocketSendTo - Send data to remote computer on page 763
Close the socket	SocketClose - Close a socket on page 740
Bind a socket (only server)	SocketBind - Bind a socket to my IP-address and port on page 738
Listening connections (only server)	SocketListen - Listen for incoming connections on page 747
Accept connections (only server)	SocketAccept - Accept an incoming connection on page 735
Get current socket state	SocketGetStatus - Get current socket state on page 1462
Example client socket application	SocketSend - Send data to remote computer on page 759
Receive data from remote computer	SocketReceive - Receive data from remote computer on page 749
Receive data from remote computer	SocketReceiveFrom - Receive data from remote computer on page 754

2.174 Sqrt - Calculates the square root value

Usage

`Sqrt` (*Square root*) is used to calculate the square root value.

Basic examples

The following example illustrates the function `Sqrt`.

Example 1

```
VAR num x_value;
VAR num y_value;
...
...
y_value := Sqrt( x_value);
```

y-value will get the square root value of x_value, that is, $\sqrt{x_value}$.

Return value

Data type: num

The square root value ($\sqrt{}$).

Arguments

`Sqrt (Value)`

Value

Data type: num

The argument value for square root, that is, $\sqrt{\text{value}}$.

Value needs to be ≥ 0 .

Limitations

The execution of the function `Sqrt(x)` will give an error if $x < 0$.

Syntax

```
Sqrt '('
  [Value ':=' ] <expression (IN) of num> ')'
```

A function with a return value of the data type num.

Related information

For information about	See
Calculate the square root value of a dnum numeric value	SqrtDnum - Calculates the square root value on page 1468
Mathematical instructions and functions	<i>Technical reference manual - RAPID Overview</i>

2 Functions

2.175 SqrtDnum - Calculates the square root value

RobotWare Base

2.175 SqrtDnum - Calculates the square root value

Usage

SqrtDnum (*Square root dnum*) is used to calculate the square root value.

Basic examples

The following example illustrates the function SqrtDnum.

Example 1

```
VAR dnum x_value;  
VAR dnum y_value;  
...  
...  
y_value := SqrtDnum(x_value);
```

y_value will get the square root value of x_value, that is, $\sqrt{x_value}$.

Return value

Data type: dnum
The square root value ($\sqrt{}$).

Arguments

SqrtDnum (Value)

Value

Data type: dnum
The argument value for square root, that is, $\sqrt{\text{value}}$.
Value needs to be ≥ 0 .

Limitations

The execution of the function Sqrt(x) will give an error if $x < 0$.

Syntax

```
SqrtDnum '('  
  [ Value ':=' ] < expression (IN) of dnum > ')'
```

A function with a return value of the data type dnum.

Related information

For information about	See
Calculate the square root value of a numeric value	Sqrt - Calculates the square root value on page 1467
Mathematical instructions and functions	<i>Technical reference manual - RAPID Overview</i>

2.176 STCalcForce - Calculate the tip force for a Servo Tool

Usage

STCalcForce is used to calculate the tip force for a Servo Tool. This function is used, for example, to find the max allowed tip force for a servo tool.

Basic examples

The following example illustrates the function STCalcForce.

Example 1

```
VAR num tip_force;
tip_force := STCalcForce(gun1, 7);
```

Calculate the tip force when the desired motor torque is 7 Nm.

Return value

Data type: num
The calculated tip force [N].

Arguments

```
STCalcForce ToolName MotorTorque
```

ToolName

Data type: string
The name of the mechanical unit.

MotorTorque

Data type: num
The desired motor torque [Nm].

Error handling

The following recoverable errors are generated and can be handled in an error handler. The system variable ERRNO will be set to:

Name	Cause of error
ERR_NO_SGUN	The specified servo tool name is not a configured servo tool.

Syntax

```
STCalcForce '('
  [ ToolName ':= ' ] < expression (IN) of string > ','
  [ MotorTorque ':= ' ] < expression (IN) of num > ';'

```

A function with a return value of the data type num.

Related information

For information about	See
Open a servo tool	STOpen - Open a Servo Tool on page 818
Close a servo tool	STClose - Close a Servo Tool on page 801

Continues on next page

2 Functions

2.176 STCalcForce - Calculate the tip force for a Servo Tool

Servo tool control

Continued

For information about	See
Calculate the motor torque	STCalcTorque - Calculate the motor torque for a servo tool on page 1471

2.177 STCalcTorque - Calculate the motor torque for a servo tool

Usage

STCalcTorque is used to calculate the motor torque for a Servo Tool. This function is used, for example, when a force calibration is performed.

Basic examples

The following example illustrates the function STCalcTorque.

Example 1

```
VAR num curr_motortorque;  
curr_motortorque := STCalcTorque( gun1, 1000);
```

Calculate the motor torque when the desired tip force is 1000 N.

Return value

Data type: num

The calculated motor torque [Nm].

Arguments

```
STCalcTorque ToolName TipForce
```

ToolName

Data type: string

The name of the mechanical unit.

TipForce

Data type: num

The desired tip force [N].

Error handling

The following recoverable errors are generated and can be handled in an error handler. The system variable `ERRNO` will be set to:

Name	Cause of error
ERR_NO_SGUN	The specified servo tool name is not a configured servo tool.

Syntax

```
STCalcTorque '('  
  [ ToolName ':= ' ] < expression (IN) of string > ','  
  [ TipForce ':= ' ] < expression (IN) of num > ';'
```

A function with a return value of the data type num.

Related information

For information about	See
Open a servo tool	STOpen - Open a Servo Tool on page 818
Close a servo tool	STClose - Close a Servo Tool on page 801

Continues on next page

2 Functions

2.177 STCalcTorque - Calculate the motor torque for a servo tool

Servo tool control

Continued

For information about	See
Calculate the tip force	STCalcForce - Calculate the tip force for a Servo Tool on page 1469

2.178 STIsCalib - Tests if a servo tool is calibrated

Usage

STIsCalib is used to test if a servo tool is calibrated - that is, check if the gun tips are calibrated or synchronized.

Basic examples

The following examples illustrate the function STIsCalib.

Example 1

```
IF STIsCalib(gun1\sguninit) THEN
  ...
ELSE
  !Start the gun calibration
  STCalib gun1\TipChg;
ENDIF
```

Example 2

```
IF STIsCalib(gun1\sgunsynch) THEN
  ...
ELSE
  !Start the gun calibration to synchronize the gun position with
  the revolution counter
  STCalib gun1\ToolChg;
ENDIF
```

Return value

Data type: bool

TRUE if the tested tool is calibrated - that is, the distance between the tool tips is calibrated, or if the tested tool is synchronized - that is, the position of the tool tips is synchronized with the revolution counter of the tool.

FALSE if the tested tool is not calibrated or synchronized.

Arguments

```
STIsCalib ToolName [\sguninit] | [\sgunsynch]
```

ToolName

Data type: string

The name of the mechanical unit.

[\sguninit]

Data type: switch

This argument is used to check if the gun position is initialized and calibrated.

[\sgunsynch]

Data type: switch

This argument is used to check if the gun position is synchronized with the revolution counter.

Continues on next page

2 Functions

2.178 STIsCalib - Tests if a servo tool is calibrated

Servo Tool Control

Continued

Syntax

```
STIsCalib '('  
  [ ToolName ':=' ] < expression (IN) of string >  
  [ '\ ' sguninit ] | [ '\ 'sgunsynch ] ')'
```

A function with a return value of the data type `bool`.

Related information

For information about	See
Calibrating a servo tool	STCalib - Calibrate a Servo Tool on page 797

2.179 STIsClosed - Tests if a servo tool is closed

Usage

STIsClosed is used to test if a servo tool is closed.

Basic examples

The following examples illustrate the function STIsClosed.

Example 1

```
IF STIsClosed(gun1) THEN
  !Start the weld process
  Set weld_start;
ELSE
  ...
ENDIF
```

Check if the gun is closed or not.

Example 2

```
STClose "sgun", 1000, 3 \Conc;
WHILE NOT(STIsClosed("sgun"\RetThickness:=thickness)) DO
  WaitTime 0.1;

ENDWHILE
IF thickness > max_thickness THEN...
```

Start to close the gun named `sgun`. Continue immediately with the next instruction in which the program waits for the gun to be closed. Read the achieved thickness value when the instruction `STIsClosed` has returned `TRUE`.

Example 3

Examples of non valid combinations:

```
STClose "sgun", 1000, 3 \RetThickness:=thickness \Conc;
WHILE NOT(STIsClosed("sgun"\RetThickness:=thickness_2)) DO;
...
```

Close the gun. The parameter `thickness` will not hold any valid value since the `\Conc` switch is used. Wait until the gun is closed. When the gun is closed and `STIsClosed` returns `TRUE`, the parameter `thickness_2` will hold a valid value since the `\Conc` switch was used for the `STClose`.

```
STClose "sgun", 1000, 3 \RetThickness:=thickness;
WHILE NOT(STIsClosed("sgun"\RetThickness:=thickness_2)) DO;
...
```

Close the gun. The parameter `thickness` will hold a valid value when the gun has been closed since the `\Conc` switch is not used. The parameter `thickness_2` will not hold any valid value since the `\Conc` switch was not used in the `STClose` instruction.

Return value

Data type: `bool`

`TRUE` if the tested tool is closed, that is, the desired tip force is achieved.

Continues on next page

2 Functions

2.179 STIsClosed - Tests if a servo tool is closed

Servo Tool Control

Continued

FALSE if the tested tool is not closed.

Arguments

STIsClosed ToolName [\RetThickness]

ToolName

Data type: string

The name of the mechanical unit.

[\RetThickness]

Data type: num

The achieved thickness [mm].

NOTE! Only valid if \Conc has been used in a preceding STClose instruction.

Syntax

```
STIsClosed '('  
  [ ToolName ':=' ] < expression (IN) of string > ')'  
  ['\RetThickness ':=' < variable or persistent (INOUT) of num  
  > ] ')'
```

A function with a return value of the data type bool.

Related information

For information about	See
Open a servo tool	STOpen - Open a Servo Tool on page 818
Close a servo tool	STClose - Close a Servo Tool on page 801
Test if a servo tool is open	STIsOpen - Tests if a servo tool is open on page 1478

2.180 STIsIndGun - Tests if a servo tool is in independent mode

Usage

STIsIndGun is used to test if a servo tool is in independent mode.

Basic examples

The following example illustrates the function STIsIndGun.

Example 1

```

IF STIsIndGun(gun1) THEN
  ! Start the gun calibration
  STCalib gun1\TipChg;
ELSE
  ...
ENDIF

```

Return value

Data type: bool

TRUE if the tested tool is in independent mode - that is, the gun can be moved independently of the robot movements.

FALSE if the tested tool is *not* in independent mode.

Arguments

STIsIndGun ToolName

ToolName

Data type: string

The name of the mechanical unit.

Syntax

```

STIsIndGun '('
  [ ToolName ':=' ] < expression (IN) of string > ')'

```

A function with a return value of the data type bool.

Related information

For information about	See
Calibrating a servo tool	STCalib - Calibrate a Servo Tool on page 797
Setting the gun in independent mode	STIndGun - Sets the servo tool in independent mode on page 806
Resetting the gun from independent mode	STIndGunReset - Resets the servo tool from independent mode on page 808

2 Functions

2.181 STIsOpen - Tests if a servo tool is open *Servo Tool Control*

2.181 STIsOpen - Tests if a servo tool is open

Usage

STIsOpen is used to test if a servo tool is open.

Basic examples

The following examples illustrate the function STIsOpen.

Example 1

```
IF STIsOpen(gun1) THEN
  !Start the motion
  MoveL ...
ELSE
  ...
ENDIF
```

Check if the gun is open or not.

Example 2

```
STCalib "sgun" \TipWear \Conc;
WHILE NOT(STIsOpen("sgun") \RetTipWear:=tipwear \RetPosAdj:=posadj)
  DO;
  WaitTime 0.1;

ENDWHILE
```

IF tipwear > 20...

IF posadj > 25...

Perform a tip wear calibration. Wait until the gun `sgun` is open. Read the tip wear and positional adjustment values.

Example 3

Examples of non valid combinations:

```
STCalib "sgun" \TipWear \RetTipWear:=tipwear_1 \Conc;
WHILE NOT(STIsOpen("sgun") \RetTipWear:=tipwear_2) DO;
  WaitTime 0.1;

ENDWHILE
```

Start a tip wear calibration. The parameter `tipwear_1` will not hold any valid value since the `\Conc` switch is used. When the calibration is ready and the `STIsOpen` returns `TRUE`, the parameter `tipwear_2` will hold a valid value.

```
STCalib "sgun" \TipWear \RetTipWear:=tipwear_1;

WHILE NOT(STIsOpen("sgun") \RetTipWear:=tipwear_2) DO;
  WaitTime 0.1;

ENDWHILE
```

Perform a tip wear calibration. The parameter `tipwear_1` will hold a valid value since the `\Conc` switch is not used. When `STIsOpen` returns `TRUE`, the parameter

Continues on next page

tipwear_2 will not hold any valid value since the \Conc switch was not used in STCalib.

Return value

Data type: bool

TRUE if the tested tool is open, that is, the tool arm is in the programmed open position.

FALSE if the tested tool is not open.

Arguments

```
STIsOpen ToolName [\RetTipWear] [\RetPosAdj]
```

ToolName

Data type: string

The name of the mechanical unit.

[\RetTipWear]

Data type: num

The achieved tip wear [mm].

NOTE! Only valid if \Conc has been used in a preceding STCalib instruction and if STIsOpen returns TRUE.

[\RetPosAdj]

Data type: num

The positional adjustment since the last calibration [mm].

NOTE! Only valid if \Conc has been used in a preceding STCalib instruction and if STIsOpen returns TRUE.

Syntax

```
STIsOpen '('
  [ ToolName ':=' ] < expression (IN) of string > ')'
  [ '\ RetTipWear ':=' < variable or persistent(INOUT) of num >
    ] ';'
  [ '\ RetPosAdj ':=' < variable or persistent(INOUT) of num > ]
```

A function with a return value of the data type bool.

Related information

For information about	See
Open a servo tool	STOpen - Open a Servo Tool on page 818
Close a servo tool	STClose - Close a Servo Tool on page 801
Test if a servo tool is closed	STIsClosed - Tests if a servo tool is closed on page 1475

2 Functions

2.182 StrDigCalc - Arithmetic operations with datatype stringdig RobotWare Base

2.182 StrDigCalc - Arithmetic operations with datatype stringdig

Usage

`StrDigCalc` is used to perform arithmetic operations (+, -, *, /, %) on two positive digit strings in the same way as numeric arithmetic operations on positive integer values.

This function can handle positive integers above 8 388 608 with exact representation.

Basic examples

The following example illustrates the function `StrDigCalc`.

See also [More examples on page 1481](#).

Example 1

```
res := StrDigCalc(str1, OpAdd, str2);
```

`res` is assigned the result of the addition operation on the values represented by the digital strings `str1` and `str2`.

Return value

Data type: `stringdig`

`stringdig` is used to represent big positive integers in a string with only digits.

This data type is introduced because the data type `num` cannot handle positive integers above 8 388 608 with exact representation.

Arguments

```
StrDigCalc (StrDig1 Operation StrDig2)
```

StrDig1

String Digit 1

Data type: `stringdig`

String representing a positive integer value.

Operation

Arithmetic operator

Data type: `opcalc`

Defines the arithmetic operation to perform on the two digit strings. Following arithmetic operations of data type `opcalc` can be used; `OpAdd`, `OpSub`, `OpMult`, `OpDiv` and `OpMod`.

StrDig2

String Digit 2

Data type: `stringdig`

String representing a positive integer value.

Continues on next page

Program execution

This function will:

- Check only digits 0...9 in StrDig1 and StrDig2
- Convert the two digital strings to long integers
- Perform an arithmetic operation on the two long integers
- Convert the result from long integer to stringdig

More examples

The following examples illustrate the function StrDigCalc.

Example 1

```
res := StrDigCalc(str1, OpSub, str2);
```

res is assigned the result of the substraction operation on the values represented by the digital strings str1 and str2.

Example 2

```
res := StrDigCalc(str1, OpMult, str2);
```

res is assigned the result of the multiplication operation on the values represented by the digital strings str1 and str2.

Example 3

```
res := StrDigCalc(str1, OpDiv, str2);
```

res is assigned the result of the division operation on the values represented by the digital strings str1 and str2.

Example 4

```
res := StrDigCalc(str1, OpMod, str2);
```

res is assigned the result of the modulus operation on the values represented by the digital strings str1 and str2.

Error handling

The following recoverable errors are generated and can be handled in an error handler. The system variable ERRNO will be set to:

Name	Cause of error
ERR_INT_NOTVAL	Input values not only digits or modulus by zero
ERR_INT_MAXVAL	Input value above 4294967295
ERR_CALC_OVERFLOW	Result out of range 0...4294967295
ERR_CALC_NEG	Negative substraction, that is, StrDig2 > StrDig1
ERR_CALC_DIVZERO	Division by zero

Limitations

StrDigCalc only accepts strings that contain digits (characters 0...9). All other characters in stringdig will result in error.

This function can only handle positive integers up to 4 294 967 295.

Continues on next page

2 Functions

2.182 StrDigCalc - Arithmetic operations with datatype stringdig

RobotWare Base

Continued

Syntax

```
StrDigCalc '('  
  [ StrDig1 ':=' ] < expression (IN) of stringdig > ','  
  [ Operation ':=' ] < expression (IN) of opcalc > ','  
  [ StrDig2 ':=' ] < expression (IN) of stringdig > ')'
```

A function with a return value of the data type stringdig.

Related information

For information about	See
Strings with only digits.	stringdig - String with only digits on page 1763
Arithmetic operators.	opcalc - Arithmetic Operator on page 1700

2.183 StrDigCmp - Compare two strings with only digits

Usage

StrDigCmp is used to compare two positive digit strings in the same way as numeric compare of positive integers.

This function can handle positive integers above 8 388 608 with exact representation.

Basic examples

The following examples illustrate the function StrDigCmp.

Example 1

```
VAR stringdig digits1 := "1234";  
VAR stringdig digits2 := "1256";  
VAR bool is_equal;  
is_equal := StrDigCmp(digits1, EQ, digits2);
```

The variable `is_equal` will be set to `FALSE`, because the numeric value 1234 is not equal to 1256.

Return value

Data type: `bool`

TRUE if the given condition is met, FALSE if not.

Arguments

```
StrDigCmp (StrDig1 Relation StrDig2)
```

StrDig1

String Digit 1

Data type: `stringdig`

The first string with only digits to be numerical compared.

Relation

Data type: `opnum`

Defines how to compare the two digit strings. Following predefined constants of data type `opnum` can be used `LT`, `LTEQ`, `EQ`, `NOTEQ`, `GTEQ` or `GT`.

StrDig2

String Digit 2

Data type: `stringdig`

The second string with only digits to be numerical compared.

Program execution

This function will:

- Check that only digits 0...9 are used in StrDig1 and StrDig2
 - Convert the two digital strings to long integers
 - Numerically compare the two long integers
-

Continues on next page

2 Functions

2.183 StrDigCmp - Compare two strings with only digits

RobotWare Base

Continued

Error handling

The following recoverable errors are generated and can be handled in an error handler. The system variable `ERRNO` will be set to:

Name	Cause of error
<code>ERR_INT_NOTVAL</code>	Input values not only digits
<code>ERR_INT_MAXVAL</code>	Value above 4294967295

Limitations

`StrDigCmp` only accepts strings that contain digits (characters 0...9). All other characters in `stringdig` will result in error.

This function can only handle positive integers up to 4 294 967 295.

Syntax

```
StrDigCmp '('  
  [ StrDig1 ':='] < expression (IN) of stringdig > ','  
  [ Relation ':='] < expression (IN) of opnum > ','  
  [ StrDig2 ':='] < expression (IN) of stringdig > ')'
```

A function with a return value of the data type `bool`.

Related information

For information about	See
String with only digits	stringdig - String with only digits on page 1763
Comparison operators	opnum - Comparison operator on page 1701
File time information	FileTimeDnum - Retrieve time information about a file on page 1277
File modify time of the loaded module	ModTimeDnum - Get file modify time for the loaded module on page 1369

2.184 StrFind - Searches for a character in a string

Usage

`StrFind` (*String Find*) is used to search in a string, starting at a specified position, for a character that belongs to a specified set of characters.

Basic examples

The following example illustrates the function `StrFind`.

Example 1

```
VAR num found;
found := StrFind("Robotics",1,"aeiou");
```

The variable `found` is given the value 2.

```
found := StrFind("Robotics",1,"aeiou"\NotInSet);
```

The variable `found` is given the value 1.

```
found := StrFind("IRB 6700",1,STR_DIGIT);
```

The variable `found` is given the value 5.

```
found := StrFind("IRB 6700",1,STR_WHITE);
```

The variable `found` is given the value 4.

Return value

Data type: `num`

The character position of the first character at or past the specified position that belongs to the specified set. If no such character is found, string length +1 is returned.

Arguments

```
StrFind (Str ChPos Set [\NotInSet])
```

Str

String

Data type: `string`

The string to search in.

ChPos

Character Position

Data type: `num`

Start character position.

Set

Data type: `string`

Set of characters to test against. See also [Predefined data on page 1486](#).

`[\NotInSet]`

Data type: `switch`

Search for a character not in the set of characters presented in `Set`.

Continues on next page

2 Functions

2.184 StrFind - Searches for a character in a string

RobotWare Base

Continued

Syntax

```
StrFind '('  
  [Str ':=' ] <expression (IN) of string> ','  
  [ChPos ':=' ] <expression (IN) of num> ','  
  [Set ':=' ] <expression (IN) of string>  
  ['\' NotInSet ] )'
```

A function with a return value of the data type num.

Predefined data

A number of predefined string constants are available in the system and can be used together with string functions.

Name	Character set
STR_DIGIT	<digit> ::= 0 1 2 3 4 5 6 7 8 9
STR_UPPER	<upper case letter> ::= A B C D E F G H I J K L M N O P Q R S T U V W X Y Z À Á Â Ã Ä Å Æ Ç È É Ê Ë Ì Í Î Ï 1) Ñ Ò Ó Ô Õ Ö Ø Ù Ú Û Ü 2) 3)
STR_LOWER	<lower case letter> ::= a b c d e f g h i j k l m n o p q r s t u v w x y z à á â ã ä å æ ç è é ê ë ì í î ï 1) ñ ò ó ô õ ö ø ù ú û ü 2) 3) ß ÿ-
STR_WHITE	<blank character> ::=

Related information

For information about	See
String functions	<i>Technical reference manual - RAPID Overview</i>
Definition of string	string - Strings on page 1761
String values	<i>Technical reference manual - RAPID Overview</i>

2.185 StrFormat - Format a string

Usage

StrFormat is used to format a text string.

Basic examples

The following example illustrates the function StrFormat:

Example 1

```
VAR string text1 := "This is a {1} and this is {2}";  
...  
TPWrite StrFormat(text1 \Arg1:="robot" \Arg2:="fast");
```

The strings used in optional arguments Arg1 and Arg2 will replace {1} and {2}.
The result will then be:

This is a robot and this is fast

Return value

Data type: string

Arguments

```
StrFormat ( Text [\Arg1] [\Arg2] [\Arg3] [\Arg4] [\Arg5] [\Arg6]  
           )
```

Text

Data type: string

The string to format.

[\Arg1]

Data type: string

If the string contains {1}, the {1} is replaced with the string used in this argument.

[\Arg2]

Data type: string

If the string contains {2}, the {2} is replaced with the string used in this argument.

[\Arg3]

Data type: string

If the string contains {3}, the {3} is replaced with the string used in this argument.

[\Arg4]

Data type: string

If the string contains {4}, the {4} is replaced with the string used in this argument.

[\Arg5]

Data type: string

If the string contains {5}, the {5} is replaced with the string used in this argument.

[\Arg6]

Data type: string

Continues on next page

2 Functions

2.185 StrFormat - Format a string

RobotWare Base

Continued

If the string contains {6}, the {6} is replaced with the string used in this argument.

Limitations

The total string length in RAPID is 80. This is the same for all inputs as result of the function.

Syntax

```
StrFormat
[Text ':=' ] <expression (IN) of string>
['\ ' Arg1 ':=' <expression (IN) of string>]
['\ ' Arg2 ':=' <expression (IN) of string>]
['\ ' Arg3 ':=' <expression (IN) of string>]
['\ ' Arg4 ':=' <expression (IN) of string>]
['\ ' Arg5 ':=' <expression (IN) of string>]
['\ ' Arg6 ':=' <expression (IN) of string>] )'
```

Related information

For information about	See
String functions	<i>Technical reference manual - RAPID Overview</i>
Data type string	string - Strings on page 1761
String values	<i>Technical reference manual - RAPID Overview</i>
<i>Advanced RAPID</i>	<i>Application manual - Controller software IRC5</i>

2.186 StrLen - Gets the string length

Usage

`StrLen` (*String Length*) is used to find the current length of a string.

Basic examples

The following example illustrates the function `StrLen`.

Example 1

```
VAR num len;  
len := StrLen("Robotics");
```

The variable `len` is given the value 8.

Return value

Data type: num

The number of characters in the string (≥ 0).

Arguments

`StrLen` (`Str`)

`Str`

String

Data type: string

The string in which the number of characters is to be counted.

Syntax

```
StrLen '('  
  [Str ':=' ] <expression (IN) of string> ')'
```

A function with a return value of the data type num.

Related information

For information about	See
String functions	<i>Technical reference manual - RAPID Instructions, Functions and Data types</i>
Definition of string	string - Strings on page 1761
String values	<i>Technical reference manual - RAPID Instructions, Functions and Data types</i>

2 Functions

2.187 StrMap - Maps a string

RobotWare Base

2.187 StrMap - Maps a string

Usage

`StrMap` (*String Mapping*) is used to create a copy of a string in which all characters are translated according to a specified mapping.

Basic examples

The following examples illustrate the function `StrMap`.

Example 1

```
VAR string str;  
str := StrMap("Robotics","aeiou","AEIOU");
```

The variable `str` is given the value `RObOtIcs`.

Example 2

```
str := StrMap("Robotics",STR_LOWER, STR_UPPER);
```

The variable `str` is given the value `ROBOTICS`.

Return value

Data type: `string`

The string created by translating the characters in the specified string, as specified by the "from" and "to" strings. Each character from the specified string that is found in the "from" string is replaced by the character at the corresponding position in the "to" string. Characters for which no mapping is defined are copied unchanged to the resulting string.

Arguments

```
StrMap ( Str FromMap ToMap)
```

`Str`

String

Data type: `string`

The string to translate.

`FromMap`

Data type: `string`

Index part of mapping. See also [Predefined data on page 1491](#).

`ToMap`

Data type: `string`

Value part of mapping. See also [Predefined data on page 1491](#).

Syntax

```
StrMap '('  
  [ Str ':= ' ] <expression (IN) of string> ','  
  [ FromMap ':= ' ] <expression (IN) of string> ','  
  [ ToMap ':= ' ] <expression (IN) of string> ')'
```

A function with a return value of the data type `string`.

Continues on next page

Predefined data

A number of predefined string constants are available in the system and can be used together with string functions.

Name	Character set
STR_DIGIT	<digit> ::= 0 1 2 3 4 5 6 7 8 9
STR_UPPER	<upper case letter> ::= A B C D E F G H I J K L M N O P Q R S T U V W X Y Z À Á Â Ã Ä Å Æ Ç È É Ê Ë Ì Í Î Ï 1) Ñ Ò Ó Ô Õ Ö Ø Ù Ú Û Ü 2) 3)
STR_LOWER	<lower case letter> ::= a b c d e f g h i j k l m n o p q r s t u v w x y z à á â ã ä å æ ç è é ê ë ì í î ï 1) ñ ò ó ô õ ö ø ù ú û ü 2) 3) ß ÿ-
STR_WHITE	<blank character> ::=

Related information

For information about	See
String functions	<i>Technical reference manual - RAPID Overview</i>
Definition of string	string - Strings on page 1761
String values	<i>Technical reference manual - RAPID Overview</i>

2 Functions

2.188 StrMatch - Search for pattern in string

RobotWare Base

2.188 StrMatch - Search for pattern in string

Usage

`StrMatch` (*String Match*) is used to search in a string, starting at a specified position, for a specified pattern.

Basic examples

The following example illustrates the function `StrMatch`.

Example 1

```
VAR num found;  
  
found := StrMatch("Robotics",1,"bo");
```

The variable `found` is given the value 3.

Return value

Data type: num

The character position of the first substring, at or past the specified position, that is equal to the specified pattern string. If no such substring is found, string length +1 is returned.

Arguments

```
StrMatch (Str ChPos Pattern)
```

Str

String

Data type: string

The string to search in.

ChPos

Character Position

Data type: num

Start character position.

Pattern

Data type: string

Pattern string to search for.

Syntax

```
StrMatch '('  
  [ Str ':' ] <expression (IN) of string> ','  
  [ ChPos ':' ] <expression (IN) of num> ','  
  [ Pattern ':' ] <expression (IN) of string> ')'
```

A function with a return value of the data type num.

Continues on next page

Related information

For information about	See
String functions	<i>Technical reference manual - RAPID Overview</i>
Definition of string	string - Strings on page 1761
String values	<i>Technical reference manual - RAPID Overview</i>

2 Functions

2.189 StrMemb - Checks if a character belongs to a set
RobotWare Base

2.189 StrMemb - Checks if a character belongs to a set

Usage

StrMemb (*String Member*) is used to check whether a specified character in a string belongs to a specified set of characters.

Basic examples

The following example illustrates the function StrMemb.

Example 1

```
VAR bool memb;  
memb := StrMemb("Robotics",2,"aeiou");
```

The variable memb is given the value TRUE, as o is a member of the set "aeiou".

```
memb := StrMemb("Robotics",3,"aeiou");
```

The variable memb is given the value FALSE, as b is not a member of the set "aeiou".

```
memb := StrMemb("S-721 68 VÄSTERÅS",3,STR_DIGIT);
```

The variable memb is given the value TRUE, as 7 is a member of the set STR_DIGIT.

Return value

Data type: bool

TRUE if the character at the specified position in the specified string belongs to the specified set of characters.

FALSE if the character is not belonging to the specified set, or if ChPos position is outside the string (Str).

Arguments

```
StrMemb (Str ChPos Set)
```

Str

String

Data type: string

The string to check in.

ChPos

Character Position

Data type: num

The character position to check.

Set

Data type: string

Set of characters to test against.

Continues on next page

Predefined data

A number of predefined string constants are available in the system and can be used together with string functions.

Name	Character set
STR_DIGIT	<digit> ::= 0 1 2 3 4 5 6 7 8 9
STR_UPPER	<upper case letter> ::= A B C D E F G H I J K L M N O P Q R S T U V W X Y Z À Á Â Ã Î Ï 1) Ñ Ò Ó Ô Õ Ö Ø Ù Ú Û Ü 2) 3)
STR_LOWER	<lower case letter> ::= a b c d e f g h i j k l m n o p q r s t u v w x y z à á â ã ä å æ ç è é ê ë ì í î ï 1) ñ ò ó ô õ ö ø ù ú û ü 2) 3) ß ÿ-
STR_WHITE	<blank character> ::=

Syntax

```
StrMemb '('
  [ Str ':' ] <expression (IN) of string> ','
  [ ChPos ':' ] <expression (IN) of num> ','
  [ Set ':' ] <expression (IN) of string> ')'
```

A function with a return value of the data type bool.

Related information

For information about	See
String functions	<i>Technical reference manual - RAPID Overview</i>
Definition of string	string - Strings on page 1761
String values	<i>Technical reference manual - RAPID Overview</i>

2 Functions

2.190 StrOrder - Checks if strings are ordered

RobotWare Base

2.190 StrOrder - Checks if strings are ordered

Usage

`StrOrder` (*String Order*) compares two strings (character by character) and returns a boolean indicating whether the two strings are in order according to a specified character ordering sequence.

Basic examples

The following examples illustrate the function `StrOrder`.

Example 1

```
VAR bool le;  
  
le := StrOrder("FIRST", "SECOND", STR_UPPER);
```

The variable `le` is given the value `TRUE`, because "F" comes before "S" in the character ordering sequence `STR_UPPER`.

Example 2

```
VAR bool le;  
  
le := StrOrder("FIRST", "FIRSTB", STR_UPPER);
```

The variable `le` is given the value `TRUE`, because "FIRSTB" has an additional character in the character ordering sequence (no character compared to "B").

Example 3

```
VAR bool le;  
  
le := StrOrder("FIRSTB", "FIRST", STR_UPPER);
```

The variable `le` is given the value `FALSE`, because "FIRSTB" has an additional character in the character ordering sequence ("B" compared to no character).

Return value

Data type: `bool`

`TRUE` if the first string comes before the second string (`Str1 <= Str2`) when characters are ordered as specified.

Characters that are not included in the defined ordering are all assumed to follow the present ones.

Arguments

```
StrOrder ( Str1 Str2 Order)
```

`Str1`

String 1

Data type: `string`

First string value.

`Str2`

String 2

Continues on next page

Data type: string

Second string value.

Order

Data type: string

Sequence of characters that define the ordering. See also [Predefined data on page 1497](#).

Predefined data

A number of predefined string constants are available in the system and can be used together with string functions.

Name	Character set
STR_DIGIT	<digit> ::= 0 1 2 3 4 5 6 7 8 9
STR_UPPER	<upper case letter> ::= A B C D E F G H I J K L M N O P Q R S T U V W X Y Z À Á Â Ã Ä Å Æ Ç È É Ê Ë Ì Í Î Ï 1) Ñ Ò Ó Ô Õ Ö Ø Ù Ú Û Ü 2) 3)
STR_LOWER	<lower case letter> ::= a b c d e f g h i j k l m n o p q r s t u v w x y z à á â ã ä å æ ç è é ê ë ì í î ï 1) ñ ò ó ô õ ö ø ù ú û ü 2) 3) ß ÿ-
STR_WHITE	<blank character> ::=

Syntax

```
StrOrder '('
  [ Str1 ':= ' ] <expression (IN) of string> ', '
  [ Str2 ':= ' ] <expression (IN) of string> ', '
  [ Order ':= ' ] <expression (IN) of string> ')'
```

A function with a return value of the data type bool.

Related information

For information about	See
String functions	<i>Technical reference manual - RAPID Overview</i>
Definition of string	string - Strings on page 1761
String values	<i>Technical reference manual - RAPID Overview</i>

2 Functions

2.191 StrPart - Finds a part of a string

RobotWare Base

2.191 StrPart - Finds a part of a string

Usage

StrPart (*String Part*) is used to find a part of a string, as a new string.

Basic examples

The following example illustrates the function StrPart.

Example 1

```
VAR string part;  
part := StrPart("Robotics",1,5);
```

The variable part is given the value "Robot".

Return value

Data type: string

The substring of the specified string which has the specified length and starts at the specified character position.

Arguments

StrPart (Str ChPos Len)

Str

String

Data type: string

The string in which a part is to be found.

ChPos

Character Position

Start character position. A runtime error is generated if the position is outside the string.

Len

Length

Data type: num

Length of string part. A runtime error is generated if the length is negative or greater than the length of the string, or if the substring is (partially) outside the string.

Syntax

```
StrPart '('  
  [ Str ':' ] <expression (IN) of string> ','  
  [ ChPos ':' ] <expression (IN) of num> ','  
  [ Len ':' ] <expression (IN) of num> ')'
```

A function with a return value of the data type string.

Related information

For information about	See
String functions	<i>Technical reference manual - RAPID Overview</i>

Continues on next page

For information about	See
Definition of string	string - Strings on page 1761
String values	<i>Technical reference manual - RAPID Overview</i>

2 Functions

2.192 StrToByte - Converts a string to a byte data

RobotWare Base

2.192 StrToByte - Converts a string to a byte data

Usage

`StrToByte` (*String To Byte*) is used to convert a string with a defined byte data format into a byte data.

Basic examples

The following example illustrates the function `StrToByte`.

Example 1

```
VAR string con_data_buffer{5} := ["10", "AE", "176", "00001010",  
    "A"];
```

```
VAR byte data_buffer{5};
```

```
data_buffer{1} := StrToByte(con_data_buffer{1});
```

The content of the array component `data_buffer{1}` will be 10 decimal after the `StrToByte ...` function.

```
data_buffer{2} := StrToByte(con_data_buffer{2}\Hex);
```

The content of the array component `data_buffer{2}` will be 174 decimal after the `StrToByte ...` function.

```
data_buffer{3} := StrToByte(con_data_buffer{3}\Okt);
```

The content of the array component `data_buffer{3}` will be 126 decimal after the `StrToByte ...` function.

```
data_buffer{4} := StrToByte(con_data_buffer{4}\Bin);
```

The content of the array component `data_buffer{4}` will be 10 decimal after the `StrToByte ...` function.

```
data_buffer{5} := StrToByte(con_data_buffer{5}\Char);
```

The content of the array component `data_buffer{5}` will be 65 decimal after the `StrToByte ...` function.

Return value

Data type: byte

The result of the conversion operation in decimal representation.

Arguments

```
StrToByte (ConStr [\Hex] | [\Okt] | [\Bin] | [\Char])
```

ConStr

Convert String

Data type: string

The string data to be converted.

If the optional switch argument is omitted, the string to be converted has decimal (Dec) format.

[\Hex]

Hexadecimal

Data type: switch

Continues on next page

The string to be converted has hexadecimal format.

[\Okt]

Octal

Data type: switch

The string to be converted has octal format.

[\Bin]

Binary

Data type: switch

The string to be converted has binary format.

[\Char]

Character

Data type: switch

The string to be converted has ASCII character format.

Limitations

Depending on the format of the string to be converted, the following string data is valid:

Format	String length	Range
Dec: '0' - '9'	3	"0" - "255"
Hex: '0' - '9', 'a' - 'f', 'A' - 'F'	2	"0" - "FF"
Okt: '0' - '7'	3	"0" - "377"
Bin: '0' - '1'	8	"0" - "11111111"
Char: Any ASCII character	1	One ASCII char

RAPID character codes (for example, "\07" for BEL control character) can be used as arguments in ConStr.

Syntax

```
StrToByte '('
  [ConStr ':=' ] <expression (IN) of string>
  ['\ ' Hex ] | ['\ ' Okt] | ['\ ' Bin] | ['\ ' Char]
  ')'
```

A function with a return value of the data type byte.

Related information

For information about	See
Convert a byte to a string data	ByteToStr - Converts a byte to a string data on page 1192
Other bit (byte) functions	<i>Technical reference manual - RAPID Overview</i>
Other string functions	<i>Technical reference manual - RAPID Overview</i>

2 Functions

2.193 StrToVal - Converts a string to a value

RobotWare Base

2.193 StrToVal - Converts a string to a value

Usage

`StrToVal` (*String To Value*) is used to convert a string to a value of any data type.

Basic examples

The following example illustrates the function `StrToVal`.

See also [More examples on page 1502](#).

Example 1

```
VAR bool ok;  
VAR num nval;  
ok := StrToVal("3.85",nval);
```

The variable `ok` is given the value `TRUE` and `nval` is given the value `3.85`.

Return value

Data type: `bool`

`TRUE` if the requested conversion succeeded, `FALSE` otherwise.

Arguments

```
StrToVal ( Str Val )
```

`Str`

String

Data type: `string`

A string value containing literal data with format corresponding to the data type used in argument `Val`. Valid format as for RAPID literal aggregates.

`Val`

Value

Data type: `anytype`

Name of the variable or persistent of any data type for storage of the result from the conversion.

All type of value data with structure atomic, record, record component, array or array element can be used. The data is unchanged if the requested conversion failed because the format don't correspond to the data used in argument `Str`.

More examples

More examples of the function `StrToVal` are illustrated below.

Example 1

```
VAR string str15 := "[600, 500, 225.3]";  
VAR bool ok;  
VAR pos pos15;  
  
ok := StrToVal(str15,pos15);
```

Continues on next page

The variable `ok` is given the value `TRUE` and the variable `pos15` is given the value that are specified in the string `str15`.

Syntax

```
StrToVal '('  
  [ Str ':=' ] <expression (IN) of string> ','  
  [ Val ':=' ] <var or pers (INOUT) of anytype>  
' )'
```

A function with a return value of the data type `bool`.

Related information

For information about	See
String functions	<i>Technical reference manual - RAPID Overview</i>
Definition of string	string - Strings on page 1761
String values	<i>Technical reference manual - RAPID Overview</i>

2 Functions

2.194 Tan - Calculates the tangent value

RobotWare Base

2.194 Tan - Calculates the tangent value

Usage

Tan (*Tangent*) is used to calculate the tangent value from an angle value.

Basic examples

The following example illustrates the function Tan.

Example 1

```
VAR num angle;  
VAR num value;  
...  
...  
value := Tan(angle);  
value will get the tangent value of angle.
```

Return value

Data type: num
The tangent value.

Arguments

Tan (Angle)

Angle

Data type: num
The angle value, expressed in degrees.

Error handling

The following recoverable errors are generated and can be handled in an error handler. The system variable ERRNO will be set to:

Name	Cause of error
ERR_TAN_DEGREES_NOTVAL	Angle 90 and 270 degrees is undefined for tan().

Syntax

```
Tan '('  
  [Angle ':='] <expression (IN) of num>  
' )'
```

A function with a return value of the data type num.

Related information

For information about	See
Mathematical instructions and functions	<i>Technical reference manual - RAPID Overview</i>
Arc tangent with return value in the range [-180,180]	ATan2 - Calculates the arc tangent2 value on page 1162

2.195 TanDnum - Calculates the tangent value

Usage

TanDnum (*Tangent*) is used to calculate the tangent value from an angle value on data types dnum.

Basic examples

The following example illustrates the function TanDnum.

Example 1

```
VAR dnum angle;
VAR dnum value;
...
...
value := TanDnum(angle);
value will get the tangent value of angle.
```

Return value

Data type: dnum
The tangent value.

Arguments

TanDnum (Angle)

Angle

Data type: dnum
The angle value, expressed in degrees.

Error handling

The following recoverable errors are generated and can be handled in an error handler. The system variable ERRNO will be set to:

Name	Cause of error
ERR_TAN_DEGREES_NOTVAL	Angle 90 and 270 degrees is undefined for tan().

Syntax

```
TanDnum '('
  [Angle ':=' ] <expression (IN) of dnum>
  ')'
```

A function with a return value of the data type dnum.

Related information

For information about	See
Mathematical instructions and functions	<i>Technical reference manual - RAPID Overview</i>
Arc tangent with return value in the range [-180,180]	ATan2Dnum - Calculates the arc tangent2 value on page 1163

2 Functions

2.196 TaskRunMec - Check if task controls any mechanical unit
RobotWare Base

2.196 TaskRunMec - Check if task controls any mechanical unit

Usage

`TaskRunMec` is used to check if the program task controls any mechanical units (robot with TCP or manipulator without TCP).

Basic examples

The following example illustrates the function `TaskRunMec`.

Example 1

```
VAR bool flag;  
...  
flag := TaskRunMec( );
```

If current task controls any mechanical unit `flag` will be `TRUE`, otherwise `FALSE`.

Return value

Data type: `bool`

If current task controls any mechanical unit the return value will be `TRUE`, otherwise `FALSE`.

Program execution

Check if current program task controls any mechanical unit.

Syntax

```
TaskRunMec '( ' )'
```

A function with a return value of the data type `bool`.

Related information

For information about	See
Check if task control some robot	TaskRunRob - Check if task controls some robot on page 1507
Activating and deactivating mechanical units	ActUnit - Activates a mechanical unit on page 30 DeactUnit - Deactivates a mechanical unit on page 184
Configuration of mechanical units	Technical reference manual - System parameters

2.197 TaskRunRob - Check if task controls some robot

Usage

`TaskRunRob` is used to check if the program task controls some robot (mechanical unit with TCP).

Basic examples

The following example illustrates the function `TaskRunRob`.

Example 1

```
VAR bool flag;
...
flag := TaskRunRob();
```

If current task controls some robot, `flag` will be set to `TRUE`, otherwise `FALSE`.

Return value

Data type: `bool`

If current task controls some robot, the return value will be `TRUE`, otherwise `FALSE`.

Program execution

Check if current program task controls some robot.

Syntax

```
TaskRunRob '(' ' ')
```

A function with a return value of the data type `bool`.

Related information

For information about	See
Check if task controls any mechanical unit	TaskRunMec - Check if task controls any mechanical unit on page 1506
Activating and deactivating mechanical units	ActUnit - Activates a mechanical unit on page 30 DeactUnit - Deactivates a mechanical unit on page 184
Configuration of mechanical units	Technical reference manual - System parameters

2 Functions

2.198 TasksInSync - Returns the number of synchronized tasks

RobotWare Base

2.198 TasksInSync - Returns the number of synchronized tasks

Usage

`TasksInSync` is used to retrieve the number of synchronized tasks.

Basic examples

The following example illustrates the function `TaskInSync`.

Example 1

```
VAR tasks tasksInSyncList{6};
...

PROC main ()
  VAR num noOfSynchTasks;
  ...
  noOfSynchTasks:= TasksInSync (tasksInSyncList);
  TPWrite "No of synchronized tasks = "\Num:=noOfSynchTasks;
ENDPROC
```

The variable `noOfSynchTasks` is assigned the number of synchronized tasks and the `tasksInSyncList` will contain the names of the synchronized tasks. In this example the task list is a variable but it can also be a persistent.

Return value

Data type: num

The number of synchronized tasks.

Arguments

`TaskInSync (TaskList)`

`TaskList`

Data type: tasks

Inout argument that in a task list (array) will present the name (string) of the program tasks that are synchronized. The task list can be either of type `VAR` or `PERS`.

Program execution

The function returns the number of synchronized tasks in the system. The names of the synchronized tasks are presented in the inout argument `TaskList`. In cases where there are no synchronized tasks, the list will only contain empty strings.

Limitations

Currently only one synch group is supported, so `TasksInSync` returns the number of tasks that are synchronized in that group.

Syntax

```
TasksInSync
  [ TaskList ':' ] < var or pers array {*} (INOUT) of tasks> ','
```

A function with a return value of the data type `num`.

Continues on next page

2.198 TasksInSync - Returns the number of synchronized tasks

RobotWare Base

Continued

Related information

For information about	See
Specify cooperated program tasks	tasks - RAPID program tasks on page 1772
Start coordinated synchronized movements	SyncMoveOn - Start coordinated synchronized movements on page 842

2 Functions

2.199 TaskIsActive - Check if a normal task is active

RobotWare Base

2.199 TaskIsActive - Check if a normal task is active

Usage

`TaskIsActive` is used to check if a normal program task is active in the **Task Selection Panel** on the FlexPendant.

Basic examples

The following example illustrates the function `TaskIsActive`.

Example 1

```
IF TaskIsActive("T_ROB1") = TSP_STATUS_ACT THEN
  TPWrite "T_ROB1 is active in the Task Selection Panel";
ENDIF
```

Check if program task `T_ROB1` is active in the **Task Selection Panel** on the FlexPendant.

Return value

Data type: `tsp_status`

The current task selection panel status.

Arguments

```
TaskIsActive ( TaskRef | TaskName )
```

TaskRef

Data type: `taskid`

The program task identity of the task that should be checked.

The predefined variables of the data type `taskid` is available for all program tasks in the system.

The variable identity is "*taskname*"+"Id", for example the variable identity for the `T_ROB1` task is `T_ROB1Id`.

TaskName

Data type: `string`

The program task name of the task that should be checked.

Predefined data

The following predefined symbolic constants of type `tsp_status` can be used to check the return value:

```
CONST tsp_status TSP_STATUS_NOT_NORMAL_TASK := 0;
CONST tsp_status TSP_STATUS_DEACT := 1;
CONST tsp_status TSP_STATUS_DEACT_SERV_ROUT := 2;
CONST tsp_status TSP_STATUS_ACT := 3;
```

Continues on next page

Error handling

The following recoverable errors are generated and can be handled in an error handler. The system variable `ERRNO` will be set to:

<code>ERR_TASKNAME</code>	The program task name in argument <code>\TaskName</code> cannot be found in the system.
---------------------------	---

Syntax

```
TaskIsActive '('
  [ TaskRef ':= ' ] <variable (VAR) of taskid>
  |[ TaskName ':= ' ] <expression (IN) of string> ')'
```

A function with a return value of the data type `tsp_status`.

Related information

For information about	See
Task selection panel status	tsp_status - Task selection panel status on page 1797
Get current task selection panel status	GetTSPStatus - Get current task selection panel status on page 1315
Check if task is executing	TaskIsExecuting - Check if task is executing on page 1512

2 Functions

2.200 TaskIsExecuting - Check if task is executing

RobotWare Base

2.200 TaskIsExecuting - Check if task is executing

Usage

`TaskIsExecuting` is used to check if a program task is executing.

Basic examples

The following example illustrates the function `TaskIsExecuting`.

Example 1

```
TPWrite "T_ROB1 is executing: " \Bool:=TaskIsExecuting("T_ROB1");
TPWrite "T_ROB2 is executing: " \Bool:=TaskIsExecuting("T_ROB2");
```

Checks if program task `T_ROB1` and `T_ROB2` is executing and writes the value on the FlexPendant.

Return value

Data type: `bool`

If the program task is executing, the return value is `TRUE`, otherwise `FALSE`.

Arguments

```
TaskIsExecuting ( TaskRef | TaskName )
```

TaskRef

Data type: `taskid`

The program task identity of the task that should be checked.

The predefined variables of the data type `taskid` is available for all program tasks in the system.

The variable identity is "*taskname*"+"Id", for example the variable identity for the `T_ROB1` task is `T_ROB1Id`.

TaskName

Data type: `string`

The program task name of the task that should be checked.

Error handling

The following recoverable errors are generated and can be handled in an error handler. The system variable `ERRNO` will be set to:

<code>ERR_TASKNAME</code>	The program task name in argument <code>\TaskName</code> cannot be found in the system.
---------------------------	---

Syntax

```
TaskIsExecuting '('
  [ TaskRef ':= ' ] <variable (VAR) of taskid>
  |[ TaskName ':= ' ] <expression (IN) of string> ')'
```

A function with a return value of the data type `bool`.

Continues on next page

Related information

For information about	See
Check if a normal task is active	TaskIsActive - Check if a normal task is active on page 1510

2 Functions

2.201 TestAndSet - Test variable and set if unset

RobotWare Base

2.201 TestAndSet - Test variable and set if unset

Usage

`TestAndSet` can be used together with a normal data object of the type `bool`, as a binary semaphore, to retrieve exclusive right to specific RAPID code areas or system resources. The function could be used both between different program tasks and different execution levels (trap or event routines) within the same program task.

Example of resources that can need protection from access at the same time:

- Use of some RAPID routines with function problems when executed in parallel.
- Use of the FlexPendant - Operator Log

Basic examples

The following example illustrates the function `TestAndSet`.

See also [More examples on page 1515](#).

Example 1

MAIN program task:

```
PERS bool tproutine_inuse := FALSE;
...
WaitUntil TestAndSet(tproutine_inuse);
TPWrite "First line from MAIN";
TPWrite "Second line from MAIN";
TPWrite "Third line from MAIN";
tproutine_inuse := FALSE;
```

BACK1 program task:

```
PERS bool tproutine_inuse := FALSE;
...
WaitUntil TestAndSet(tproutine_inuse);
TPWrite "First line from BACK1";
TPWrite " Second line from BACK1";
TPWrite "Third line from BACK1";
tproutine_inuse := FALSE;
```

To avoid mixing up the lines, in the Operator Log, one from `MAIN` and one from `BACK1`, the use of the `TestAndSet` function guarantees that all three lines from each task are not separated.

If program task `MAIN` takes the semaphore `TestAndSet(tproutine_inuse)` first, then program task `BACK1` must wait until the program task `MAIN` has left the semaphore.

Return value

Data type: `bool`

`TRUE` if the semaphore has been taken by me (executor of `TestAndSet` function), otherwise `FALSE`.

Continues on next page

Arguments

TestAndSet Object

Object

Data type: bool

User defined data object to be used as semaphore. The data object could be a variable VAR or a persistent variable PERS. If TestAndSet are used between different program tasks, the object must be a persistent variable PERS or an installed variable VAR (intertask objects).

Program execution

This function will in one indivisible step check the user defined variable and, if it is unset, will set it and return TRUE, otherwise it will return FALSE.

```
IF Object = FALSE THEN
  Object := TRUE;
  RETURN TRUE;
ELSE
  RETURN FALSE;
ENDIF
```

More examples

The following example illustrates the function TestAndSet.

Example 1

```
LOCAL VAR bool doit_inuse := FALSE;
...
PROC doit(...)
  WaitUntil TestAndSet (doit_inuse);
  ...
  doit_inuse := FALSE;
ENDPROC
```

If a module is installed built-in and shared, it is possible to use a local module variable for protection of access from different program tasks at the same time.



Note

In this case with installed built-in modules and when using persistent variable as semaphore object: If program execution is stopped in the routine `doit` and the program pointer is moved to `main`, the variable `doit_inuse` will not be reset. To avoid this, reset the variable `doit_inuse` to `FALSE` in the `START` event routine.

Syntax

```
TestAndSet '('
  [ Object ':=' ] < variable or persistent (INOUT) of bool> ')'
```

A function with a return value of the data type bool.

Continues on next page

2 Functions

2.201 TestAndSet - Test variable and set if unset

RobotWare Base

Continued

Related information

For information about	See
Wait until variable unset - then set (type wait with interrupt control)	WaitTestAndSet - Wait until variable becomes FALSE, then set on page 1074

2.202 TestDI - Tests if a digital input is set

Usage

TestDI is used to test whether a digital input is set.

Basic examples

The following example illustrates the function TestDI.

Example 1

```
IF TestDI (di2) THEN . . .
```

If the current value of the signal di2 is equal to 1, then . . .

```
IF NOT TestDI (di2) THEN . . .
```

If the current value of the signal di2 is equal to 0, then . . .

```
WaitUntil TestDI(di1) AND TestDI(di2);
```

Program execution continues only after both the di1 input and the di2 input have been set.

Return value

Data type: bool

TRUE = The current value of the signal is equal to 1.

FALSE = The current value of the signal is equal to 0.

Arguments

```
TestDI (Signal)
```

Signal

Data type: signaldi

The name of the signal to be tested.

Error handling

The following recoverable errors are generated and can be handled in an error handler. The system variable ERRNO will be set to:

Name	Cause of error
ERR_NO_ALIASIO_DEF	The signal variable is a variable declared in RAPID. It has not been connected to an I/O signal defined in the I/O configuration with instruction AliasIO.
ERR_NORUNUNIT	There is no contact with the I/O device.
ERR_SIG_NOT_VALID	The I/O signal cannot be accessed. The reasons can be that the I/O device is not running or an error in the configuration (only valid for ICI field bus).

Syntax

```
TestDI '('  
  [ Signal ::= ] < variable (VAR) of signaldi > ')'
```

A function with a return value of the data type bool.

Continues on next page

2 Functions

2.202 TestDI - Tests if a digital input is set

RobotWare Base

Continued

Related information

For information about	See
Reading the value of a digital input signal	signalxx - Digital and analog signals on page 1747
Reading the value of a digital output signal	DOutput - Reads the value of a digital output signal on page 1265
Input/Output instructions	<i>Technical reference manual - RAPID Overview</i>

2.203 TestSignRead - Read test signal value

Usage

`TestSignRead` is used to read the actual test signal value.

This function returns the momentary value or the mean value of the latest samples, depending on channel specification in instruction `TestSignDefine`.

Basic examples

The following example illustrates the function `TestSignRead`.

See also [More examples on page 1520](#).

Example 1

```
CONST num speed_channel:=1;
VAR num speed_value;
...
TestSignDefine speed_channel, testsignal_speed, orbit, 1, 0;
...
! During some movements with orbit's axis 1
speed_value := TestSignRead(speed_channel);
...
TestSignReset;
```

`speed_value` is assigned the mean value of the latest 8 samples generated each 0.5 ms of the test signal `testsignal_speed` on channel `speed_channel` defined as channel 1. The channel `speed_channel` measures the speed of axis 1 on the mechanical unit `orbit`.

Return value

Data type: num

The numeric value in SI units on the motor side for the specified channel according to the definition in instruction `TestSignDefine`.

Arguments

```
TestSignRead (Channel)
```

Channel

Data type: num

The channel number 1-12 for the test signal to be read. The same number must be used in the definition instruction `TestSignDefine`.

Program execution

Returns the momentary value or the mean value of the latest samples, depending on the channel specification in the instruction `TestSignDefine`.

For predefined test signals with valid SI units for external manipulator axes, see **data type** `testsignal`.

Continues on next page

2 Functions

2.203 TestSignRead - Read test signal value

RobotWare Base

Continued

More examples

The following example illustrates the function `TestSignRead`.

Example 1

```
CONST num torque_channel:=2;
VAR num torque_value;
VAR intnum timer_int;
CONST jointtarget psync := [...];
...
PROC main()
  CONNECT timer_int WITH TorqueTrap;
  ITimer \Single, 0.05, timer_int;
  TestSignDefine torque_channel, testsignal_torque_ref, IRBP_K, 2,
    0.001;
  ...
  MoveAbsJ psync \NoEOffs, v5, fine, tool0;
  ...
  IDelete timer_int;
  TestSignReset;

TRAP TorqueTrap
  IF (TestSignRead(torque_channel) > 6) THEN
    TPWrite "Torque pos = " + ValToStr(CJointT());
    Stop;
  ELSE
    IDelete timer_int;
    CONNECT timer_int WITH TorqueTrap;
    ITimer \Single, 0.05, timer_int;
  ENDIF
ENDTRAP
```

When the torque reference for manipulator IRBP_K axis 2 is for the first time greater than 6 Nm on the motor side during the slow movement to position `psync`, the joint position is displayed on the FlexPendant.

Syntax

```
TestSignRead '('
  [ Channel ':='] <expression (IN) of num> ')'
```

A function with a return value of the type `num`.

Related information

For information about	See
Test signal	testsignal - Test signal on page 1774
Define test signal	TestSignDefine - Define test signal on page 860
Reset test signals	TestSignReset - Reset all test signal definitions on page 862

2.204 TextGet - Get text from system text tables

Usage

`TextGet` is used to get a text string from the system text tables.

Basic examples

The following examples illustrate the function `TextGet`.

Example 1

```
VAR string text1;
...
text1 := TextGet(14, 5);
```

The variable `text1` is assigned the text stored in text resource 14 and index 5.

Example 2

```
...
TPWrite TextGet(14, 511 \Arg1:="robot" \Arg2:="fast");
```

The text stored in text resource 14 and index 511 is read. The text read from the text tables looks like this: This is a {1} and this {1} is {2}. The strings used in optional arguments `Arg1` and `Arg2` will replace {1} and {2}. The result will then be:

```
This is a robot and this robot is fast
```

Return value

Data type: string

Specified text from the system text tables.

Arguments

```
TextGet ( Table Index \Arg1 \Arg2 \Arg3 \Arg4 \Arg5 \Arg6)
```

Table

Data type: num

The text table number (positive integer).

Index

Data type: num

The index number (positive integer) within the text table.

[\Arg1]

Data type: string

If the string read from the text table contains {1}, the {1} is replaced with the string used in this argument.

[\Arg2]

Data type: string

If the string read from the text table contains {2}, the {2} is replaced with the string used in this argument.

Continues on next page

2 Functions

2.204 TextGet - Get text from system text tables

RobotWare Base

Continued

[\Arg3]

Data type: string

If the string read from the text table contains {3}, the {3} is replaced with the string used in this argument.

[\Arg4]

Data type: string

If the string read from the text table contains {4}, the {4} is replaced with the string used in this argument.

[\Arg5]

Data type: string

If the string read from the text table contains {5}, the {5} is replaced with the string used in this argument.

[\Arg6]

Data type: string

If the string read from the text table contains {6}, the {6} is replaced with the string used in this argument.

Error handling

The following recoverable errors are generated and can be handled in an error handler. The system variable `ERRNO` will be set to:

Name	Cause of error
ERR_TXTNOEXIST	Table or index is not valid, and no text string can be fetched from the system text tables.

Limitations

The total string length in RAPID is 80. This is the same for all inputs as result of the function.

Syntax

```
TextGet '('  
  [Table ':='] <expression (IN) of num>', '  
  [Index ':='] <expression (IN) of num>  
  ['\' Arg1 ':=' <expression (IN) of string>]  
  ['\' Arg2 ':=' <expression (IN) of string>]  
  ['\' Arg3 ':=' <expression (IN) of string>]  
  ['\' Arg4 ':=' <expression (IN) of string>]  
  ['\' Arg5 ':=' <expression (IN) of string>]  
  ['\' Arg6 ':=' <expression (IN) of string>]')'
```

A function with a return value of the data type string.

Related information

For information about	See
Get text table number	TextTabGet - Get text table number on page 1526

Continues on next page

For information about	See
Install text table	TextTabInstall - Installing a text table on page 863
Format text files	<i>Technical reference manual - RAPID kernel</i>
String functions	<i>Technical reference manual - RAPID Overview</i>
Definition of string	string - Strings on page 1761
String values	<i>Technical reference manual - RAPID Overview</i>
<i>Advanced RAPID</i>	<i>Application manual - Controller software IRC5</i>

2 Functions

2.205 TextTabFreeToUse - Test whether text table is free

RobotWare Base

2.205 TextTabFreeToUse - Test whether text table is free

Usage

`TextTabFreeToUse` should be used to test whether the text table name (text resource string) is free to use (not already installed in the system), that is, whether it is possible to install the text table in the system or not.

Basic examples

The following example illustrates the function `TextTabFreeToUse`.

Example 1

```
! System Module with Event Routine to be executed at event  
! POWER ON, RESET or START
```

```
PROC install_text()  
  IF TextTabFreeToUse("text_table_name") THEN  
    TextTabInstall "HOME:/text_file.xml";  
  ENDIF  
ENDPROC
```

The first time the event routine `install_text` is executed, the function `TextTabFreeToUse` returns `TRUE` and the text file `text_file.xml` is installed in the system. After that the installed text strings can be fetched from the system to `RAPID` by the functions `TextTabGet` and `TextGet`.

Next time the event routine `install_text` is executed, the function `TextTabFreeToUse` returns `FALSE` and the installation is not repeated.

Return value

Data type: `bool`

This function returns:

- `TRUE`, if the text table is not already installed in the system
 - `FALSE`, if the text table is already installed in the system
-

Arguments

```
TextTabFreeToUse ( TableName )
```

TableName

Data type: `string`

The text table name. The string length is limited to 20 characters.

See `<text_resource>` in *Technical reference manual - RAPID kernel*, section *Text files*. The string `text_resource` is the text table name.

Limitations

Limitations for installation of text tables (text resources) in the system:

- It is not possible to install the same text table more than once in the system
 - It is not possible to uninstall (free) a single text table from the system. The only way to uninstall text tables from the system is to restart the controller
-

Continues on next page

using the restart mode **Reset system**. All text tables (both system and user defined) will then be uninstalled.

Syntax

```
TextTabFreeToUse '('  
  [TableName ':=' ] <expression (IN) of string>')'
```

A function with a return value of the data type `bool`.

Related information

For information about	See
Install text table	TextTabInstall - Installing a text table on page 863
Format of text files	<i>Technical reference manual - RAPID kernel</i>
Get text table number	TextTabGet - Get text table number on page 1526
Get text from system text tables	TextGet - Get text from system text tables on page 1521
String functions	<i>Technical reference manual - RAPID Overview</i>
Definition of string	string - Strings on page 1761
<i>Advanced RAPID</i>	<i>Product specification - Controller software IRC5</i>

2 Functions

2.206 TextTabGet - Get text table number

RobotWare Base

2.206 TextTabGet - Get text table number

Usage

`TextTabGet` is used to get the text table number of a user defined text table during run time.

Basic examples

The following examples illustrate the function `TextTabGet`.

Both examples use a new text table named `deburr_part1` for user defined texts. The new text table has the file name `deburr.xml`. It is also possible to use `.eng` format but `.xml` is recommended.

Example code in .xml format

```
<?xml version="1.0" encoding="ISO-8859-1"?>
<Resource Language="en" Name="deburr_part1">
  <Text Name="1">
    <Value>Part 1 is not in pos</Value>
    <Comment>Maximum length 80 chars</Comment>
  </Text>
  <Text Name="2">
    <Value>Identity of worked part: XYZ</Value>
    <Comment>Maximum length 80 chars</Comment>
  </Text>
  <Text Name="3">
    <Value>Part error in line 1</Value>
    <Comment>Maximum length 80 chars</Comment>
  </Text>
</Resource>
```

Example 1

```
VAR num text_res_no;
...
text_res_no := TextTabGet("deburr_part1");
```

The variable `text_res_no` is assigned the text table number for the defined text table `deburr_part1`.

Example 2

```
ErrWrite TextGet(text_res_no, 1), TextGet(text_res_no, 2);
```

A message is stored in the robot log. The message is also shown on the FlexPendant display. The messages will be taken from the text table `deburr_part1`:

Part 1 is not in pos

Identity of worked part: XYZ

Example code in .eng format

```
# deburr.eng - USERS deburr_part1 english text description file
#
# DESCRIPTION:
# Users text file for RAPID development
#
```

Continues on next page

```

deburrr_part1::
0:
RAPID S4: Users text table deburring part1
1:
Part 1 is not in pos
2:
Identity of worked part: XYZ
3:
Part error in line 1
#
# End of file

```

Return value

Data type: num

The text table number of the defined text table.

Arguments

```
TextTabGet ( TableName )
```

TableName

Data type: string

The text table name.

Syntax

```
TextTabGet '('
  [TableName '='] <expression (IN) of string>';')
```

A function with a return value of the data type num.

Related information

For information about	See
Get text from system text tables	TextGet - Get text from system text tables on page 1521
Install text table	TextTabInstall - Installing a text table on page 863
Format text files	<i>Technical reference manual - RAPID kernel</i>
String functions	<i>Technical reference manual - RAPID Overview</i>
Definition of string	string - Strings on page 1761
String values	<i>Technical reference manual - RAPID Overview</i>
<i>Advanced RAPID</i>	<i>Application manual - Controller software IRC5</i>

2 Functions

2.207 TriggDataValid - Check if the content in a triggdata variable is valid

RobotWare Base

2.207 TriggDataValid - Check if the content in a triggdata variable is valid

Usage

TriggDataValid function is used to check if a triggdata variable is valid. A valid triggdata variable is a variable that earlier has been used in the program in one of the instructions TriggIO, TriggEquip, TriggInt, TriggSpeed, TriggCheckIO or TriggRampAO to specify trigger conditions and trigger activity.

Basic examples

The following example illustrates the function TriggDataValid.

Example 1

```
VAR triggdata trigg_array{25};
...
PROC MyTriggProcL(robtarget myrobt, \VAR triggdata T1 \VAR triggdata
    T2 \VAR triggdata T3)
    VAR num triggcnt:=2;
    ! Reset entire trigg_array array before using it
    FOR i FROM 1 TO 25 DO
        TriggDataReset trigg_array{i};
    ENDFOR
    TriggEquip trigg_array{1}, 10 \Start, 0 \Dop:=do1, SetValue:=1;
    TriggEquip trigg_array{2}, 40 \Start, 0 \Dop:=do2, SetValue:=1;
    ! Check if optional argument is present,
    ! and if any trigger condition has been setup in T1
    IF Present(T1) AND TriggDataValid(T1) THEN
        ! Copy actual trigger condition to trigg_array
        TriggDataCopy trigg_array{triggcnt}, T1;
        Incr triggcnt;
    ENDIF
    IF Present(T2) AND TriggDataValid(T2) THEN
        Incr triggcnt;
        TriggDataCopy trigg_array{triggcnt}, T2;
    ENDIF
    IF Present(T3) AND TriggDataValid(T3) THEN
        Incr triggcnt;
        TriggDataCopy trigg_array{triggcnt}, T3;
    ENDIF
    TriggL pl, v500, trigg_array, z30, tool2;
    ...
```

The procedure MyTriggProcL above uses the TriggDataValid instruction to check if any valid data is used in the optional arguments T1, T2 and T3.

Return value

Data type: bool

Continues on next page

2.207 TriggDataValid - Check if the content in a triggdata variable is valid

RobotWare Base

Continued

This function returns:

- TRUE, if the variable is valid, i.e. one of the instructions TriggIO, TriggEquip, TriggInt, TriggSpeed, TriggCheckIO or TriggRampAO has been used to specify trigger conditions and trigger activity.
- FALSE, if the variable has not been used when setting up any trigger condition and trigger activity.

Arguments

TriggDataValid TriggData

TriggData

Data type: triggdata

The triggdata variable to check if valid.

Syntax

```
TriggDataValid
  [TriggData '[:=' ] < variable (VAR) of triggdata > ';' ]
```

A function with a return value of the data type bool.

Related information

For information about	See
Linear movement with triggers	TriggL - Linear robot movements with events on page 935
Joint movement with triggers	TriggJ - Axis-wise robot movements with events on page 927
Circular movement with triggers	TriggC - Circular robot movement with events on page 891
Definition of triggers	TriggIO - Define a fixed position or time I/O event near a stop point on page 921 TriggEquip - Define a fixed position and time I/O event on the path on page 910 TriggInt - Defines a position related interrupt on page 916 TriggCheckIO - Defines I/O check at a fixed position on page 900 TriggRampAO - Define a fixed position ramp AO event on the path on page 958 TriggSpeed - Defines TCP speed proportional analog output with fixed position-time scale event on page 965
Handling triggdata	triggdata - Positioning events, trigg on page 1785 TriggDataReset - Reset the content in a triggdata variable on page 908 TriggDataCopy - Copy the content in a triggdata variable on page 906

2 Functions

2.208 Trunc - Truncates a numeric value

RobotWare Base

2.208 Trunc - Truncates a numeric value

Usage

`Trunc` (*Truncate*) is used to truncate a numeric value to a specified number of decimals or to an integer value.

Basic examples

The following examples illustrate the function `Trunc`.

Example 1

```
VAR num val;  
val := Trunc(0.3852138\Dec:=3);
```

The variable `val` is given the value 0.385.

Example 2

```
reg1 := 0.3852138;  
val := Trunc(reg1\Dec:=1);
```

The variable `val` is given the value 0.3.

Example 3

```
val := Trunc(0.3852138);
```

The variable `val` is given the value 0.

Example 4

```
val := Trunc(0.3852138\Dec:=6);
```

The variable `val` is given the value 0.385213.

Return value

Data type: num

The numeric value truncated to the specified number of decimals.

Arguments

```
Trunc ( Val [ \Dec ] )
```

Val

Value

Data type: num

The numeric value to be truncated.

[\Dec]

Decimals

Data type: num

Number of decimals.

If the specified number of decimals is 0 or if the argument is omitted, the value is truncated to an integer.

The number of decimals must not be negative or greater than the available precision for numeric values.

Max number of decimals that can be used is 6.

Continues on next page

Syntax

```
Trunc '('  
  [ Val ':=' ] <expression (IN) of num>  
  [ \Dec ':=' <expression (IN) of num> ] ')'
```

A function with a return value of the data type num.

Related information

For information about	See
Mathematical instructions and functions	<i>Technical reference manual - RAPID Overview</i>
Rounding a value	Round - Round a numeric value on page 1450

2 Functions

2.209 TruncDnum - Truncates a numeric value

RobotWare Base

2.209 TruncDnum - Truncates a numeric value

Usage

`TruncDnum` (*Truncate dnum*) is used to truncate a numeric value to a specified number of decimals or to an integer value.

Basic examples

The following examples illustrate the function `TruncDnum`.

Example 1

```
VAR dnum val;  
val := TruncDnum(0.3852138754655357\Dec:=3);
```

The variable `val` is given the value 0.385.

Example 2

```
val := TruncDnum(0.3852138754655357\Dec:=1);
```

The variable `val` is given the value 0.3.

Example 3

```
val := TruncDnum(0.3852138754655357);
```

The variable `val` is given the value 0.

Example 4

```
val := TruncDnum(0.3852138754655357\Dec:=15);
```

The variable `val` is given the value 0.385213875465535.

Example 5

```
val := TruncDnum(1000.3852138754655357\Dec:=15);
```

The variable `val` is given the value 1000.38521387547.

Return value

Data type: `dnum`

The numeric value truncated to the specified number of decimals.

Arguments

```
TruncDnum ( Val [\Dec] )
```

`Val`

Value

Data type: `dnum`

The numeric value to be truncated.

`[\Dec]`

Decimals

Data type: `num`

Number of decimals.

If the specified number of decimals is 0 or if the argument is omitted, the value is truncated to an integer.

Continues on next page

The number of decimals must not be negative or greater than the available precision for numeric values.

Max number of decimals that can be used is 15.

Syntax

```
TruncDnum '('
  [ Val ':=' ] <expression (IN) of dnum>
  [ \Dec ':=' <expression (IN) of num> ] ')'
```

A function with a return value of the data type dnum.

Related information

For information about	See
Mathematical instructions and functions	<i>Technical reference manual - RAPID Overview</i>
Truncating a value	Trunc - Truncates a numeric value on page 1530
Rounding a value	Round - Round a numeric value on page 1450
Rounding a value	RoundDnum - Round a numeric value on page 1452

2 Functions

2.210 Type - Get the data type name for a variable

RobotWare Base

2.210 Type - Get the data type name for a variable

Usage

`Type` is used to get the data type name for the specified variable in argument `Data`.

Basic examples

The following examples illustrate the function `Type`.

Example 1

```
VAR string rettype;
VAR intnum intnumtype;
...
PROC main()
  rettype := Type(intnumtype);
  TPWrite "Data type name: " + rettype;
```

The print out will be: "Data type name: intnum"

Example 2

```
VAR string rettype;
VAR intnum intnumtype;
...
PROC main()
  rettype := Type(intnumtype \BaseName);
  TPWrite "Data type name: " + rettype;
```

The print out will be: "Data type name: num"

Example 3

```
VAR string rettype;
VAR num numtype;
...
PROC main()
  rettype := Type(numtype);
  TPWrite "Data type name: " + rettype;
```

The print out will be: "Data type name: num"

Return value

Data type: string

A string with the data type name for the specified variable in argument `Data`.

Arguments

`Type (Data [\BaseName])`

`Data`

Data object name

Data type: anytype

The name of the variable to get the data type name for.

`[\BaseName]`

Base data type Name

Continues on next page

Data type: switch

If used, then the function returns the underlying data type name, when the specified Data is an ALIAS declared data type.

Syntax

```
Type '('  
  [ Data ':=' ] < reference (REF) of anytype >  
  [ '\ ' BaseName ] ')'
```

A function with a return value of the data type string.

Related information

For information about	See
Definition of Alias types	<i>Technical reference manual - RAPID kernel</i> ALIAS - Assigning an alias data type on page 1599

2 Functions

2.211 UIAlphaEntry - User Alpha Entry

RobotWare Base

2.211 UIAlphaEntry - User Alpha Entry

Usage

UIAlphaEntry (*User Interaction Alpha Entry*) is used to let the operator enter a string from the available user device, such as the FlexPendant. A message is written to the operator, who answers with a text string. The string is then transferred back to the program.

Basic examples

The following example illustrates the function UIAlphaEntry.

See [More examples on page 1540](#).

Example 1

```
VAR string answer;  
...  
answer := UIAlphaEntry(  
  \Header:= "UIAlphaEntry Header",  
  \Message:= "Which procedure do You want to run?"  
  \Icon:=iconInfo  
  \InitString:= "default_proc");  
%answer%;
```

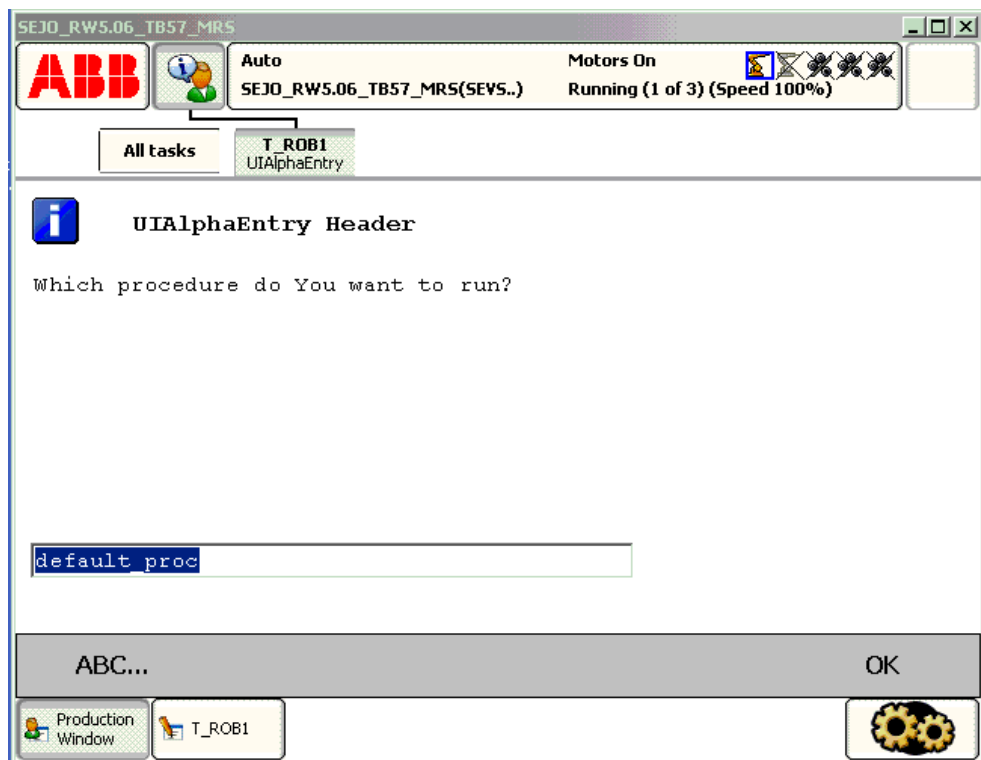

xx0500002437

The message box with icon, header, message, and initial string are shown on the FlexPendant. The user can edit the string or write a new string with the soft keyboard. Program execution waits until OK is tapped and then the string is returned

Continues on next page

in the variable `answer`. The program then calls the specified procedure with late binding.

Return value

Data type: `string`

This functions returns the input string.

If function breaks via `\BreakFlag`:

- If parameter `\InitString` is specified, this string is returned
- If parameter `\InitString` is not specified, empty string "" is returned.

If function breaks via `ERROR` handler, no return value will be returned at all.

Arguments

```
UIAlphaEntry ([\Header] [\Message][\MsgArray]
              [\Wrap][\Icon][\InitString] [\MaxTime] [\DIBreak] [\DIPassive]
              [\DOBreak] [\DOPassive] [\PersBoolBreak] [\PersBoolPassive]
              [\BreakFlag] [\UIActiveSignal])
```

`[\Header]`

Data type: `string`

Header text to be written at the top of the message box. Max. 40 characters.

`[\Message]`

Data type: `string`

One text line to be written on the display. Max 55 characters.

`[\MsgArray]`

Message Array

Data type: `string`

Several text lines from an array to be written on the display.

Only one of parameters `\Message` or `\MsgArray` can be used at the same time.

Max. layout space is 9 lines with 55 characters.

`[\Wrap]`

Data type: `switch`

If selected, all the specified strings in the argument `\MsgArray` will be concatenated to one string with single space between each individual strings and spread out on as few lines as possible.

Default, each string in the argument `\MsgArray` will be on separate line on the display.

`[\Icon]`

Data type: `icondata`

Defines the icon to be displayed. Only one of the predefined icons of type `icondata` can be used. See [Predefined data on page 1540](#).

Default no icon.

Continues on next page

2 Functions

2.211 UIAlphaEntry - User Alpha Entry

RobotWare Base

Continued

`[\InitString]`

Data type: `string`

An initial string to be display in the text entry box as default.

`[\MaxTime]`

Data type: `num`

The maximum amount of time in seconds that program execution waits. If the OK button is not pressed within this time, the program continues to execute in the error handler unless the `BreakFlag` is used (see below). The constant `ERR_TP_MAXTIME` can be used to test whether or not the maximum time has elapsed.

`[\DIBreak]`

Digital Input Break

Data type: `signal di`

The digital input signal that may interrupt the operator dialog. If the OK button is not pressed before the signal is set to 1 (or is already 1), the program continues to execute in the error handler, unless the `BreakFlag` is used (see below). The constant `ERR_TP_DIBREAK` can be used to test whether or not this has occurred.

`[\DIPassive]`

Digital Input Passive

Data type: `switch`

This switch overrides the default behavior when using `DIBreak` optional argument. Instead of reacting when signal is set to 1 (or already 1), the instruction should continue in the error handler (if no `BreakFlag` is used) when the signal `DIBreak` is set to 0 (or already is 0). The constant `ERR_TP_DIBREAK` can be used to test whether or not this has occurred.

`[\DOBreak]`

Digital Output Break

Data type: `signal do`

The digital output signal that may interrupt the operator dialog. If the OK button is not pressed before the signal is set to 1 (or is already 1), the program continues to execute in the error handler, unless the `BreakFlag` is used (see below). The constant `ERR_TP_DOBREAK` can be used to test whether or not this has occurred.

`[\DOPassive]`

Digital Output Passive

Data type: `switch`

This switch overrides the default behavior when using `DOBreak` optional argument. Instead of reacting when signal is set to 1 (or already 1), the instruction should continue in the error handler (if no `BreakFlag` is used) when the signal `DOBreak` is set to 0 (or already is 0). The constant `ERR_TP_DOBREAK` can be used to test whether or not this has occurred.

Continues on next page

[\PersBoolBreak]

Persistent Boolean Break

Data type: bool

The persistent boolean that may interrupt the operator dialog. If no button is selected when the persistent boolean is set to TRUE (or is already TRUE) then the program continues to execute in the error handler unless the BreakFlag is used (see below). The constant ERR_TP_PERSBOOLBREAK can be used to test whether or not this has occurred.

[\PersBoolPassive]

Persistent Boolean Passive

Data type: switch

This switch overrides the default behavior when using PersBoolBreak optional argument. Instead of reacting when persistent boolean is set to TRUE (or already TRUE), the instruction should continue in the error handler (if no BreakFlag is used) when the persistent boolean PersBoolBreak is set to FALSE (or already is FALSE). The constant ERR_TP_PERSBOOLBREAK can be used to test whether or not this has occurred.

[\BreakFlag]

Data type: errnum

A variable that will hold the error code if MaxTime, DIBreak, DOBreak, or PersBoolBreak is used. If this optional variable is omitted then the error handler will be executed. The constants ERR_TP_MAXTIME, ERR_TP_DIBREAK, ERR_TP DOBREAK, and ERR_TP_PERSBOOLBREAK can be used to select the reason.

[\UIActiveSignal]

Data type: signaldo

The digital output signal used in optional argument UIActiveSignal is set to 1 when the message box is activated on the FlexPendant. When the user selection has been done and the execution continue, the signal is set to 0 again.

No supervision of stop or restart exist. The signal is set to 0 when the function is ready, or when PP is moved.

Program execution

The alpha message box with alpha pad, icon, header, message lines, and init string are displayed according to the programmed arguments. Program execution waits until the user edits or creates a new string and presses OK, or the message box is interrupted by time-out or signal action. The input string and interrupt reason are transferred back to the program.

New message box on trap level takes the focus from the message box on the basic level.

Continues on next page

2 Functions

2.211 UIAlphaEntry - User Alpha Entry

RobotWare Base

Continued

Predefined data

The following constants of the data type `icondata` are predefined in the system:

Value	Constant	Icon
0	<code>iconNone</code>	No icon
1	<code>iconInfo</code>	Information icon
2	<code>iconWarning</code>	Warning icon
3	<code>iconError</code>	Error icon
4	<code>iconQuestion</code>	Question icon

Error handling

The following recoverable errors are generated and can be handled in an error handler. The system variable `ERRNO` will be set to:

Name	Cause of error
<code>ERR_NO_ALIASIO_DEF</code>	The signal variable is a variable declared in RAPID and it has not been connected to an I/O signal defined in the I/O configuration with instruction <code>AliasIO</code> .
<code>ERR_TP_NO_CLIENT</code>	There is no client, for example, a FlexPendant, to take care of the instruction.
<code>ERR_UI_ICON</code>	The argument <code>Icon</code> of type <code>icondata</code> has a not allowed value.

If parameter `\BreakFlag` is not used, these situations can then be dealt with by the error handler:

If there is a time-out (parameter `\MaxTime`) before an input from the operator, the system variable `ERRNO` is set to `ERR_TP_MAXTIME` and the execution continues in the error handler.

If digital input is set (parameter `\DIBreak`) before an input from the operator, the system variable `ERRNO` is set to `ERR_TP_DIBREAK` and the execution continues in the error handler.

If a digital output is set (parameter `\DOBBreak`) before an input from the operator, the system variable `ERRNO` is set to `ERR_TP_DOBREAK` and the execution continues in the error handler.

If a persistent boolean is set (parameter `\PersBoolBreak`) before an input from the operator, the system variable `ERRNO` is set to `ERR_TP_PERSBOOLBREAK` and the execution continues in the error handler.

More examples

The following example illustrates the function `UIAlphaEntry`.

Example 1

```
VAR errnum err_var;
VAR string answer;
VAR string logfile;
...
answer := UIAlphaEntry (\Header:= "Log file name:"
    \Message:= "Enter the name of the log file to create?")
```

Continues on next page

```

\Icon:=iconInfo
\InitString:= "signal.log"
\MaxTime:=60
\DIBreak:=di5\BreakFlag:=err_var);
TEST err_var
CASE ERR_TP_MAXTIME:
CASE ERR_TP_DIBREAK:
    ! No operator answer
    logfile:="signal.log";
CASE 0:
    ! Operator answer
    logfile := answer;
DEFAULT:
    ! No such case defined
ENDTEST

```

The message box is displayed and the operator can enter a string and press OK. The message box can also be interrupted with time out or break by digital input signal. In the program it is possible to find out the reason and take the appropriate action.

Limitations

Avoid using too small a value for the time-out parameter `\MaxTime` when `UIAlphaEntry` is frequently executed, for example in a loop. It can result in an unpredictable behavior of the system performance, like slow response of the FlexPendant.

Syntax

```

UIAlphaEntry '('
  ['\' Header ':=' <expression (IN) of string>]
  ['\' Message ':=' <expression (IN) of string>]
  | ['\' MsgArray ':='<array {*} (IN) of string>]
  ['\' Wrap]
  ['\' Icon ':=' <expression (IN) of icondata>]
  ['\' InitString ':='<expression (IN) of string>]
  ['\' MaxTime ':=' <expression (IN) of num>]
  ['\' DIBreak ':=' <variable (VAR) of signaldi>]
  ['\' DIPassive]
  ['\' DOBreak ':='<variable (VAR) of signaldo>]
  ['\' DOPassive]
  ['\' PersBoolBreak ':=' <persistent (PERS) of bool>]
  ['\' PersBoolPassive]
  ['\' BreakFlag ':=' <var or pers (INOUT) of errnum>]
  ['\' UIActiveSignal ':=' <variable (VAR) of signaldo>] ')'

```

A function with return value of the data type `string`.

Related information

For information about	See
Icon display data	icondata - Icon display data on page 1671

Continues on next page

2 Functions

2.211 UIAlphaEntry - User Alpha Entry

RobotWare Base

Continued

For information about	See
User interaction message box type basic	UIMsgBox - User Message Dialog Box type basic on page 992
User interaction message box type advanced	UIMessageBox - User Message Box type advanced on page 1567
User interaction number entry	UINumEntry - User Number Entry on page 1576
User interaction number tune	UINumTune - User Number Tune on page 1583
User interaction list view	UIListView - User List View on page 1558
System connected to FlexPendant etc.	UIClientExist - Exist User Client on page 1543
Procedure call with late binding	<i>Technical reference manual - RAPID Overview</i>
Clean up the operator window	TPErase - Erases text printed on the FlexPendant on page 865

2.212 UIClientExist - Exist User Client

Usage

UIClientExist (*User Interaction Client Exist*) is used to check if some User Device such as the FlexPendant is connected to the controller.

Basic examples

The following example illustrates the function UIClientExist.

Example 1

```
IF UIClientExist() THEN
  ! Possible to get answer from the operator
  ! The TPReadFK and UIMsgBox ... can be used
ELSE
  ! Not possible to communicate with any operator
ENDIF
```

The test is done if it is possible to get some answer from the operator of the system.

Return value

Data type: `bool`

Returns `TRUE` if a FlexPendant is connected to the system, otherwise `FALSE`.

Limitations

UIClientExist returns `TRUE` up to 16 seconds. After that, the FlexPendant is removed. After that time, UIClientExist returns `FALSE` (i.e when network connection lost from FlexPendant is detected). Same limitation when the FlexPendant is connected again.

Syntax

```
UIClientExist '(' '')
```

A function with return value of the type `bool`.

Related information

For information about	See
User interaction message box type basic	UIMsgBox - User Message Dialog Box type basic on page 992
User interaction message box type advanced	UIMessageBox - User Message Box type advanced on page 1567
User interaction number entry	UINumEntry - User Number Entry on page 1576
User interaction number tune	UINumTune - User Number Tune on page 1583
User interaction alpha entry	UIAlphaEntry - User Alpha Entry on page 1536
User interaction list view	UIListView - User List View on page 1558
Clean up the operator window	TPERase - Erases text printed on the Flex-Pendant on page 865

2 Functions

2.213 UIDnumEntry - User Number Entry

RobotWare Base

2.213 UIDnumEntry - User Number Entry

Usage

UIDnumEntry (*User Interaction Number Entry*) is used to let the operator enter a numeric value from the available user device, such as the FlexPendant. A message is written to the operator, who answers with a numeric value. The numeric value is then checked, approved and transferred back to the program.

Basic examples

The following example illustrates the function UIDnumEntry.

See also [More examples on page 1549](#).

Example 1

```
VAR dnum answer;  
...  
answer := UIDnumEntry(  
  \Header:="UIDnumEntry Header"  
  \Message:="How many units should be produced?"  
  \Icon:=iconInfo  
  \InitValue:=50000000  
  \MinValue:=10000000  
  \MaxValue:=100000000  
  \AsInteger);
```

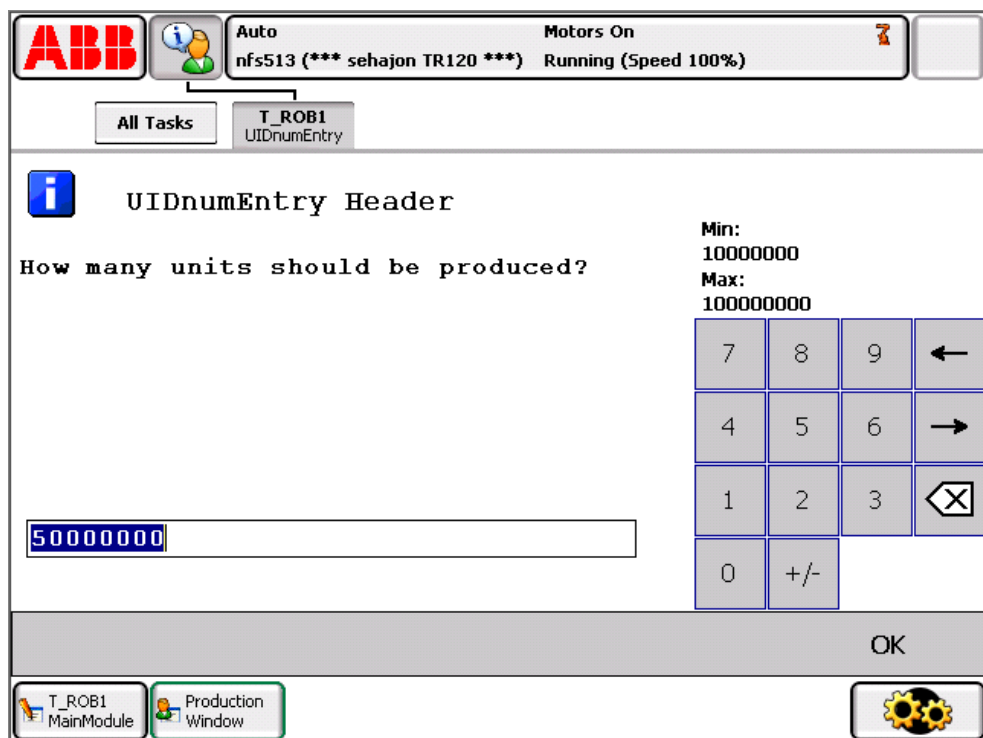

xx0900001064

The numeric message box with icon, header, message, initial, maximum, and minimum values are shown on the FlexPendant. The message box checks that the

Continues on next page

operator selects an integer within the value range. Program execution waits until OK is pressed and then the selected numerical value is returned.

Return value

Data type: dnum

This function returns the input numeric value.

If function breaks via `\BreakFlag`:

- If parameter `\InitValue` is specified, this value is returned
- If parameter `\InitValue` is not specified, value 0 is returned.

If function breaks via `ERROR` handler there is no return value at all.

Arguments

```
UIDnumEntry ( [\Header] [\Message] | [\MsgArray]
              [\Wrap][\Icon][\InitValue] [\MinValue] [\MaxValue]
              [\AsInteger][\MaxTime] [\DIBreak] [\DIPassive] [\DOBreak]
              [\DOPassive] [\PersBoolBreak] [\PersBoolPassive] [\BreakFlag]
              [\UIActiveSignal])
```

`[\Header]`

Data type: string

Header text to be written at the top of the message box. Max. 40 characters.

`[\Message]`

Data type: string

One text line to be written on the display. Max. 40 characters.

`[\MsgArray]`

Message Array

Data type: string

Several text lines from an array to be written on the display.

Only one of parameters `Message` or `MsgArray` can be used at the same time.

Max. layout space is 9 lines with 40 characters.

`[\Wrap]`

Data type: switch

If selected, all the specified strings in the argument `\MsgArray` will be concatenated to one string with a single space between each individual string, and spread out on as few lines as possible.

Default, each string in the argument `\MsgArray` will be on a separate line on the display.

`[\Icon]`

Data type: icondata

Defines the icon to be displayed. Only one of the predefined icons of type `icondata` can be used. See [Predefined data on page 1548](#).

Default no icon.

Continues on next page

2 Functions

2.213 UIDnumEntry - User Number Entry

RobotWare Base

Continued

`[\InitValue]`

Data type: dnum

Initial value that is displayed in the entry box.

`[\MinValue]`

Data type: dnum

The minimum value for the return value.

`[\MaxValue]`

Data type: dnum

The maximum value for the return value.

`[\AsInteger]`

Data type: switch

Eliminates the decimal point from the number pad to ensure that the return value is an integer.

`[\MaxTime]`

Data type: num

The maximum amount of time in seconds that program execution waits. If the OK button is not pressed within this time, the program continues to execute in the error handler unless the `BreakFlag` is used (see below). The constant `ERR_TP_MAXTIME` can be used to test whether or not the maximum time has elapsed.

`[\DIBreak]`

Digital Input Break

Data type: signaldi

The digital input signal that may interrupt the operator dialog. If the OK button is not pressed before the signal is set to 1 (or is already 1) then the program continues to execute in the error handler unless the `BreakFlag` is used (see below). The constant `ERR_TP_DIBREAK` can be used to test whether or not this has occurred.

`[\DIPassive]`

Digital Input Passive

Data type: switch

This switch overrides the default behavior when using `DIBreak` optional argument. Instead of reacting when signal is set to 1 (or already 1), the instruction should continue in the error handler (if no `BreakFlag` is used) when the signal `DIBreak` is set to 0 (or already is 0). The constant `ERR_TP_DIBREAK` can be used to test whether or not this has occurred.

`[\DOBreak]`

Digital Output Break

Data type: signaldo

The digital output signal that may interrupt the operator dialog. If the OK button is not pressed before the signal is set to 1 (or is already 1) then the program continues

Continues on next page

to execute in the error handler unless the `BreakFlag` is used (see below). The constant `ERR_TP_DOBREAK` can be used to test whether or not this has occurred.

`[\DOPassive]`

Digital Output Passive

Data type: `switch`

This switch overrides the default behavior when using `DOBreak` optional argument. Instead of reacting when signal is set to 1 (or already 1), the instruction should continue in the error handler (if no `BreakFlag` is used) when the signal `DOBreak` is set to 0 (or already is 0). The constant `ERR_TP_DOBREAK` can be used to test whether or not this has occurred.

`[\PersBoolBreak]`

Persistent Boolean Break

Data type: `bool`

The persistent boolean that may interrupt the operator dialog. If no button is selected when the persistent boolean is set to `TRUE` (or is already `TRUE`) then the program continues to execute in the error handler unless the `BreakFlag` is used (see below). The constant `ERR_TP_PERSBOOLBREAK` can be used to test whether or not this has occurred.

`[\PersBoolPassive]`

Persistent Boolean Passive

Data type: `switch`

This switch overrides the default behavior when using `PersBoolBreak` optional argument. Instead of reacting when persistent boolean is set to `TRUE` (or already `TRUE`), the instruction should continue in the error handler (if no `BreakFlag` is used) when the persistent boolean `PersBoolBreak` is set to `FALSE` (or already is `FALSE`). The constant `ERR_TP_PERSBOOLBREAK` can be used to test whether or not this has occurred.

`[\BreakFlag]`

Data type: `errnum`

A variable that will hold the error code if `MaxTime`, `DIBreak`, `DOBreak`, or `PersBoolBreak` is used. If this optional variable is omitted then the error handler will be executed. The constants `ERR_TP_MAXTIME`, `ERR_TP_DIBREAK`, `ERR_TP_DOBREAK`, and `ERR_TP_PERSBOOLBREAK` can be used to select the reason.

`[\UIActiveSignal]`

Data type: `signaldo`

The digital output signal used in optional argument `UIActiveSignal` is set to 1 when the message box is activated on the FlexPendant. When the user selection has been done and the execution continue, the signal is set to 0 again.

No supervision of stop or restart exist. The signal is set to 0 when the function is ready, or when PP is moved.

Continues on next page

2 Functions

2.213 UIDnumEntry - User Number Entry

RobotWare Base

Continued

Program execution

The numeric message box with numeric pad, icon, header, message lines, init-, max-, and minvalue is displayed according to the programmed arguments. Program execution waits until the user has entered an approved numeric value and pressed OK or the message box is interrupted by timeout or signal action. The input numeric value and interrupt reason are transferred back to the program.

New message box on trap level takes the focus from the message box on the basic level.

Predefined data

The following constants of the data type `icondata` are predefined in the system:

Value	Constant	Icon
0	<code>iconNone</code>	No icon
1	<code>iconInfo</code>	Information icon
2	<code>iconWarning</code>	Warning icon
3	<code>iconError</code>	Error icon
4	<code>iconQuestion</code>	Question icon

Error handling

The following recoverable errors are generated and can be handled in an error handler. The system variable `ERRNO` will be set to:

Name	Cause of error
<code>ERR_NO_ALIASIO_DEF</code>	The signal variable is a variable declared in RAPID and it has not been connected to an I/O signal defined in the I/O configuration with instruction <code>AliasIO</code> .
<code>ERR_TP_NO_CLIENT</code>	There is no client, for example, a FlexPendant, to take care of the instruction.
<code>ERR_UI_ICON</code>	The argument <code>Icon</code> of type <code>icondata</code> has a not allowed value.
<code>ERR_UI_INITVALUE</code>	The initial value (parameter <code>\InitValue</code>) is not specified within the range of the minimum and maximum value (parameters <code>\MinValue</code> and <code>\MaxValue</code>).
<code>ERR_UI_MAXMIN</code>	The minimum value (parameter <code>\MinValue</code>) is greater than the maximum value (parameter <code>\MaxValue</code>).
<code>ERR_UI_NOTINT</code>	The initial value (parameter <code>\InitValue</code>) is not an integer as specified in the parameter <code>\AsInteger</code> .

If parameter `\BreakFlag` is not used, these situations can then be dealt with by the error handler:

- If there is a time-out (parameter `\MaxTime`) before an input from the operator then the system variable `ERRNO` is set to `ERR_TP_MAXTIME` and the execution continues in the error handler.
- If digital input is set (parameter `\DIBreak`) before an input from the operator then the system variable `ERRNO` is set to `ERR_TP_DIBREAK` and the execution continues in the error handler.

Continues on next page

- If a digital output is set (parameter `\DOBreak`) before an input from the operator then the system variable `ERRNO` is set to `ERR_TP_DOBREAK` and the execution continues in the error handler.
- If a persistent boolean is set (parameter `\PersBoolBreak`) before an input from the operator then the system variable `ERRNO` is set to `ERR_TP_PERSBOOLBREAK` and the execution continues in the error handler.

This situation can only be dealt with by the error handler:

More examples

The following example illustrates the function `UIDnumEntry`.

Example 1

```

VAR errnum err_var;
VAR dnum answer;
VAR dnum distance;
...
answer := UIDnumEntry (\Header:= "BWD move on path"
  \Message:="Enter the path overlap?" \Icon:=iconInfo
  \InitValue:=5 \MinValue:=0 \MaxValue:=10
  \MaxTime:=60 \DIBreak:=di5 \BreakFlag:=err_var);
TEST err_var
CASE ERR_TP_MAXTIME:
CASE ERR_TP_DIBREAK:
  ! No operator answer distance := 5;
CASE 0
  ! Operator answer
  distance := answer;
DEFAULT:
  ! No such case defined
ENDTEST

```

The message box is displayed and the operator can enter a numeric value and press OK. The message box can also be interrupted with a time out or break by digital input signal. In the program, it is possible to find out the reason and take the appropriate action.

Limitations

Avoid using too small a value for the timeout parameter `\MaxTime` when `UIDnumEntry` is frequently executed, for example, in a loop. It can result in unpredictable behavior from the system performance, like the slow response of the FlexPendant.

Syntax

```

UIDnumEntry '('
  ['\' Header :=' <expression (IN) of string>]
  [Message :=' <expression (IN) of string> ]
  | ['\' MsgArray :=' <array {*} (IN) of string>]
  ['\' Wrap]
  ['\' Icon :=' <expression (IN) of icondata>]
  ['\' InitValue :=' <expression (IN) of dnum>]

```

Continues on next page

2 Functions

2.213 UIDnumEntry - User Number Entry

RobotWare Base

Continued

```
['\' MinValue ':=' <expression (IN) of dnum>]  
['\' MaxValue ':=' <expression (IN) of dnum>]  
['\' AsInteger]  
['\' MaxTime ':=' <expression (IN) of num>]  
['\' DIBreak ':=' <variable (VAR) of signaldi>]  
['\' DIPassive]  
['\' DOBreak ':=' <variable (VAR) of signaldo>]  
['\' DOPassive]  
['\' PersBoolBreak ':=' <persistent (PERS) of bool>]  
['\' PersBoolPassive]  
['\' BreakFlag ':=' <var or pers (INOUT) of errnum>]  
['\' UIActiveSignal ':=' <variable (VAR) of signaldo>] ''
```

A function with return value of the data type `dnum`.

Related information

For information about	See
Icon display data	icondata - Icon display data on page 1671
User interaction message box type basic	UIMsgBox - User Message Dialog Box type basic on page 992
User interaction message box type advanced	UIMessageBox - User Message Box type advanced on page 1567
User interaction number entry	UINumEntry - User Number Entry on page 1576
User interaction number tune	UIDnumTune - User Number Tune on page 1551
User interaction number tune	UINumTune - User Number Tune on page 1583
User interaction alpha entry	UIAlphaEntry - User Alpha Entry on page 1536
User interaction list view	UIListView - User List View on page 1558
System connected to FlexPendant etc.	UIClientExist - Exist User Client on page 1543
Clean up the operator window	TPErase - Erases text printed on the Flex-Pendant on page 865

2.214 UIDnumTune - User Number Tune

Usage

UIDnumTune (*User Interaction Number Tune*) is used to let the operator tune a numeric value from the available user device, such as the FlexPendant. A message is written to the operator, who tunes a numeric value. The tuned numeric value is then checked, approved and transferred back to the program.

Basic examples

The following example illustrates the function UIDnumTune.

See also [More examples on page 1556](#).

Example 1

```
VAR dnum flow;
...
flow := UIDnumTune(
  \Header:="UIDnumTune Header"
  \Message:="Tune the flow?"
  \Icon:=iconInfo,
  10000000,
  1000000
  \MinValue:=1000000
  \MaxValue:=20000000);
```

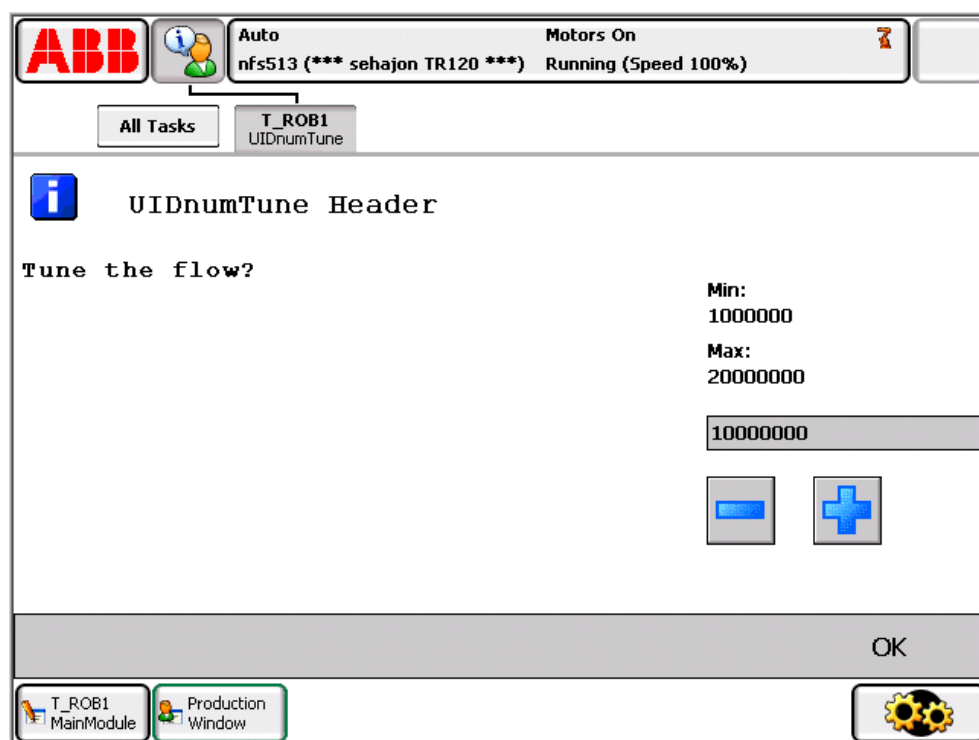

xx0900001063

The numeric tune message box with icon, header, message, initial, increment, maximum, and minimum values are shown on the FlexPendant. The message box checks that the operator tunes the `flow` value with step (increment) 1000000 from

Continues on next page

2 Functions

2.214 UIDnumTune - User Number Tune

RobotWare Base

Continued

the initial value 10000000 and is within the value range 1000000-20000000. Program execution waits until OK is pressed and then the selected numerical value is returned and stored in the variable `flow`.

Return value

Data type: `dnum`

This function returns the tuned numeric value.

If function breaks via `\BreakFlag`, the specified `InitValue` is returned.

If function breaks via `ERROR` handler, no return value is returned at all.

Arguments

```
UIDnumTune ( [\Header] [\Message] | [\MsgArray] [\Wrap]
             [\Icon]InitValue Increment [\MinValue] [\MaxValue]
             [\MaxTime][\DIBreak] [\DIPassive] [\DOBreak] [\DOPassive]
             [\PersBoolBreak] [\PersBoolPassive] [\BreakFlag]
             [\UIActiveSignal])
```

`[\Header]`

Data type: `string`

Header text to be written at the top of the message box. Max. 40 characters.

`[\Message]`

Data type: `string`

One text line to be written on the display. Max. 40 characters.

`[\MsgArray]`

Message Array

Data type: `string`

Several text lines from an array to be written on the display.

Only one of parameters `Message` or `MsgArray` can be used at the same time.

Max. layout space is 9 lines with 40 characters.

`[\Wrap]`

Data type: `switch`

If selected, all the specified strings in the argument `\MsgArray` will be concatenated to one string with a single space between each individual string and spread out on as few lines as possible.

Default, each string in the argument `\MsgArray` will be on a separate line on the display.

`[\Icon]`

Data type: `icondata`

Defines the icon to be displayed. Only one of the predefined icons of type `icondata` can be used. See [Predefined data on page 1555](#).

Default no icon.

`InitValue`

Initial Value

Continues on next page

Data type: dnum

Initial value that is displayed in the entry box.

Increment

Data type: dnum

This parameter specifies how much the value should change when the plus or minus button is pressed.

[\MinValue]

Data type: dnum

The minimum value for the return value.

[\MaxValue]

Data type: dnum

The maximum value for the return value.

[\MaxTime]

Data type: num

The maximum amount of time in seconds that program execution waits. If the OK button is not pressed within this time, the program continues to execute in the error handler unless the `BreakFlag` is used (see below). The constant `ERR_TP_MAXTIME` can be used to test whether or not the maximum time has elapsed.

[\DIBreak]

Digital Input Break

Data type: signaldi

The digital input signal that may interrupt the operator dialog. If the OK button is not pressed before the signal is set to 1 (or is already 1) then the program continues to execute in the error handler unless the `BreakFlag` is used (see below). The constant `ERR_TP_DIBREAK` can be used to test whether or not this has occurred.

[\DIPassive]

Digital Input Passive

Data type: switch

This switch overrides the default behavior when using `DIBreak` optional argument. Instead of reacting when signal is set to 1 (or already 1), the instruction should continue in the error handler (if no `BreakFlag` is used) when the signal `DIBreak` is set to 0 (or already is 0). The constant `ERR_TP_DIBREAK` can be used to test whether or not this has occurred.

[\DOBreak]

Digital Output Break

Data type: signaldo

The digital output signal that may interrupt the operator dialog. If the OK button is not pressed before the signal is set to 1 (or is already 1) then the program continues

Continues on next page

2 Functions

2.214 UIDnumTune - User Number Tune

RobotWare Base

Continued

to execute in the error handler unless the `BreakFlag` is used (see below). The constant `ERR_TP_DOBREAK` can be used to test whether or not this has occurred.

`[\DOPassive]`

Digital Output Passive

Data type: `switch`

This switch overrides the default behavior when using `DOBreak` optional argument. Instead of reacting when signal is set to 1 (or already 1), the instruction should continue in the error handler (if no `BreakFlag` is used) when the signal `DOBreak` is set to 0 (or already is 0). The constant `ERR_TP_DOBREAK` can be used to test whether or not this has occurred.

`[\PersBoolBreak]`

Persistent Boolean Break

Data type: `bool`

The persistent boolean that may interrupt the operator dialog. If no button is selected when the persistent boolean is set to `TRUE` (or is already `TRUE`) then the program continues to execute in the error handler unless the `BreakFlag` is used (see below). The constant `ERR_TP_PERSBOOLBREAK` can be used to test whether or not this has occurred.

`[\PersBoolPassive]`

Persistent Boolean Passive

Data type: `switch`

This switch overrides the default behavior when using `PersBoolBreak` optional argument. Instead of reacting when persistent boolean is set to `TRUE` (or already `TRUE`), the instruction should continue in the error handler (if no `BreakFlag` is used) when the persistent boolean `PersBoolBreak` is set to `FALSE` (or already is `FALSE`). The constant `ERR_TP_PERSBOOLBREAK` can be used to test whether or not this has occurred.

`[\BreakFlag]`

Data type: `errnum`

A variable that will hold the error code if `MaxTime`, `DIBreak`, `DOBreak`, or `PersBoolBreak` is used. If this optional variable is omitted then the error handler will be executed. The constants `ERR_TP_MAXTIME`, `ERR_TP_DIBREAK`, `ERR_TP_DOBREAK`, and `ERR_TP_PERSBOOLBREAK` can be used to select the reason.

`[\UIActiveSignal]`

Data type: `signaldo`

The digital output signal used in optional argument `UIActiveSignal` is set to 1 when the message box is activated on the FlexPendant. When the user selection has been done and the execution continue, the signal is set to 0 again.

No supervision of stop or restart exist. The signal is set to 0 when the function is ready, or when PP is moved.

Continues on next page

Program execution

The numeric tune message box with tune +/- buttons, icon, header, message lines, init-, increment, max, and minvalue is displayed according to the programmed arguments. Program execution waits until the user has tuned the numeric value and pressed OK or the message box is interrupted by timeout or signal action. The input numeric value and interrupt reason are transferred back to the program.

New message box on trap level takes the focus from the message box on the basic level.

Predefined data

The following constants of the data type `icondata` are predefined in the system:

Value	Constant	Icon
0	<code>iconNone</code>	No icon
1	<code>iconInfo</code>	Information icon
2	<code>iconWarning</code>	Warning icon
3	<code>iconError</code>	Error icon
4	<code>iconQuestion</code>	Question icon

Error handling

The following recoverable errors are generated and can be handled in an error handler. The system variable `ERRNO` will be set to:

Name	Cause of error
<code>ERR_NO_ALIASIO_DEF</code>	The signal variable is a variable declared in RAPID and it has not been connected to an I/O signal defined in the I/O configuration with instruction <code>AliasIO</code> .
<code>ERR_TP_NO_CLIENT</code>	There is no client, for example, a FlexPendant, to take care of the instruction.
<code>ERR_UI_ICON</code>	The argument <code>Icon</code> of type <code>icondata</code> has a not allowed value.
<code>ERR_UI_INITVALUE</code>	The initial value (parameter <code>\InitValue</code>) is not specified within the range of the minimum and maximum value (parameters <code>\MinValue</code> and <code>\MaxValue</code>).
<code>ERR_UI_MAXMIN</code>	The minimum value (parameter <code>\MinValue</code>) is greater than the maximum value (parameter <code>\MaxValue</code>).

If parameter `\BreakFlag` is not used then these situations can be dealt with by the error handler:

- If there is a timeout (parameter `\MaxTime`) before an input from the operator, the system variable `ERRNO` is set to `ERR_TP_MAXTIME` and the execution continues in the error handler.
- If a digital input is set (parameter `\DIBreak`) before an input from the operator, the system variable `ERRNO` is set to `ERR_TP_DIBREAK` and the execution continues in the error handler.

Continues on next page

2 Functions

2.214 UIDnumTune - User Number Tune

RobotWare Base

Continued

- If a digital output is set (parameter `\DOBreak`) before an input from the operator, the system variable `ERRNO` is set to `ERR_TP_DOBREAK` and the execution continues in the error handler.
- If a persistent boolean is set (parameter `\PersBoolBreak`) before an input from the operator then the system variable `ERRNO` is set to `ERR_TP_PERSBOOLBREAK` and the execution continues in the error handler.

More examples

The following example illustrates the function `UIDnumTune`.

Example 1

```
VAR errnum err_var;
VAR dnum tune_answer;
VAR dnum distance;
...
tune_answer := UIDnumTune (\Header:=" BWD move on path"
  \Message:="Enter the path overlap?" \Icon:=iconInfo,
  5, 1 \MinValue:=0 \MaxValue:=10
  \MaxTime:=60 \DIBreak:=di5 \BreakFlag:=err_var);
TEST err_var
CASE ERR_TP_MAXTIME:
CASE ERR_TP_DIBREAK:
  ! No operator answer
  distance := 5;
CASE 0:
  ! Operator answer
  distance := tune_answer;
DEFAULT:
  ! No such case defined
ENDTEST
```

The tune message box is displayed and the operator can tune the numeric value and press OK. The message box can also be interrupted with timeout or break by digital input signal. In the program, it is possible to find out the reason and take the appropriate action.

Limitations

Avoid using too small a value for the timeout parameter `\MaxTime` when `UIDnumTune` is frequently executed, for example, in a loop. It can result in unpredictable behavior from the system performance, like a slow response of the FlexPendant.

Syntax

```
UIDnumTune '('
  ['\' Header ::= ' <expression (IN) of string>]
  ['\' Message ::= ' <expression (IN) of string> ]
  | ['\' MsgArray ::= ' <array {*} (IN) of string>]
  ['\' Wrap]
  ['\' Icon ::= ' <expression (IN) of icondata> ' , ' ]
  [InitValue ::= ' ] <expression (IN) of dnum> ' , ' ]
```

Continues on next page

```

[Increment ':='] <expression (IN) of dnum>
['\ ' MinValue ':='] <expression (IN) of dnum>]
['\ ' MaxValue ':='] <expression(IN) of dnum>]
['\ ' MaxTime ':='] <expression (IN) of num>]
['\ ' DIBreak ':='] <variable (VAR) of signaldi>]
['\ ' DIPassive]
['\ ' DOBreak ':='] <variable (VAR) of signaldo>]
['\ ' DOPassive]
['\ ' PersBoolBreak ':='] <persistent (PERS) of bool>]
['\ ' PersBoolPassive]
['\ ' BreakFlag ':='] <var or pers (INOUT) of errnum>]
['\ ' UIActiveSignal ':='] <variable (VAR) of signaldo>] ')'

```

A function with return value of the data type `dnum`.

Related information

For information about	See
Icon display data	icondata - Icon display data on page 1671
User interaction message box type basic	UIMsgBox - User Message Dialog Box type basic on page 992
User interaction message box type advanced	UIMessageBox - User Message Box type advanced on page 1567
User interaction number entry	UIDnumEntry - User Number Entry on page 1544
User interaction number entry	UINumEntry - User Number Entry on page 1576
User interaction number tune	UINumTune - User Number Tune on page 1583
User interaction alpha entry	UIAlphaEntry - User Alpha Entry on page 1536
User interaction list view	UIListView - User List View on page 1558
System connected to FlexPendant etc.	UIClientExist - Exist User Client on page 1543
Clean up the operator window	TPErase - Erases text printed on the Flex-Pendant on page 865

2 Functions

2.215 UICollection - User List View

RobotWare Base

2.215 UICollection - User List View

Usage

`UICollection` (*User Interaction List View*) is used to define menu lists with text and optional icons on the available User Device such as the FlexPendant. The menu has two different styles, one with validation buttons and one that reacts instantly to the user selection.

Basic examples

The following example illustrates the function `UICollection`.

See also [More examples on page 1564](#).

Example 1

```
CONST listitem list{3} := [ ["", "Item 1"], ["", "Item 2"],
                           ["", "Item 3"] ];
VAR num list_item;
VAR btnres button_answer;
...
list_item := UICollection (
  \Result:=button_answer
  \Header:="UICollection Header",
  list
  \Buttons:=btnOKCancel
  \Icon:=iconInfo
  \DefaultIndex:=1);
IF button_answer = resOK THEN
  IF list_item = 1 THEN
    ! Do item1
  ELSEIF list_item = 2 THEN
    ! Do item 2
  ELSE
    ! Do item3
  ENDIF
ELSE
  ! User has select Cancel
ENDIF
```

Continues on next page

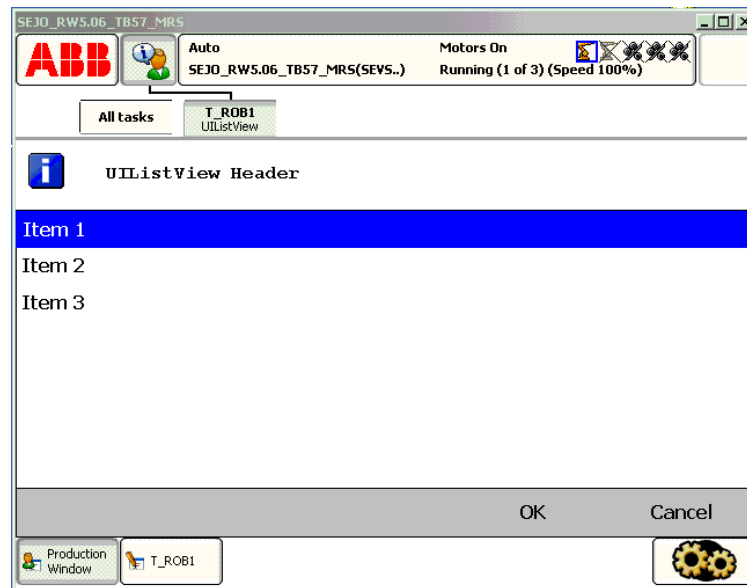

xx0500002416

The menu list with icon, header, menu Item 1 ... Item 3, and buttons is shown on the FlexPendant. Program execution waits until OK or Cancel is pressed. Both the selection in the list and the pressed button are transferred to the program.

Return value

Data type: num

This function returns the user selection in the list menu corresponding to the index in the array specified in the parameter `ListItems`.

If the function breaks via `\BreakFlag`:

- If parameter `\DefaultIndex` is specified, this index is returned
- If parameter `\DefaultIndex` is not specified, 0 is returned

If function breaks via `ERROR` handler, no return value is returned at all.

Arguments

```
UListView ( [\Result] [\Header] ListItems [\Buttons] | [\BtnArray]
[\Icon] [\DefaultIndex ] [\MaxTime] [\DIBreak] [\DIPassive]
[\DOBreak] [\DOPassive] [\PersBoolBreak] [\PersBoolPassive]
[\BreakFlag] [\UIActiveSignal])
```

`[\Result]`

Data type: btnres

The numeric value of the button that is selected from the list menu box.

If argument `\Buttons` is used, the predefined symbolic constants of type `btnres` is returned. If argument `\BtnArray` is used, the corresponding array index is returned.

Argument `\Result` set to `resUnkwn` equal to 0 if one of following condition:

- none of parameters `\Buttons` or `\BtnArray` are used
- argument `\Buttons := btnNone` is used

Continues on next page

2 Functions

2.215 UICollection - User List View

RobotWare Base

Continued

- if the function breaks via `\BreakFlag` or `ERROR` handler

See [Predefined data on page 1563](#).

`[\Header]`

Data type: `string`

Header text to be written at the top of the list menu box. Max. 40 characters.

`ListItems`

Data type: `listitem`

An array with one or several list menu items to be displayed consisting of:

Component `image` of type `string`:

The name of the icon image that should be used. To launch own images, the images has to be placed in the `HOME :` directory in the active system or directly in the active system.

The recommendation is to place the files in the `HOME :` directory so that they are saved if a Backup and Restore is done.

A Restart is required and then the FlexPendant loads the images.

A demand on the system is that the RobotWare option *FlexPendant Interface* is used.

The image that will be shown can have the width and height of 28 pixels. If the image is bigger, then it will be resized to show only 28 * 28 pixels.

No exact value can be specified on the size that an image can have or the amount of images that can be loaded to the FlexPendant. It depends on the size of other files loaded to the FlexPendant. The program execution will just continue if an image is used that has not been loaded to the FlexPendant.

Use empty string `""` or `stEmpty` if no icon to display.

Component `text` of type `string`:

- The text for the menu line to display.
- Max. 75 characters for each list menu item.

`[\Buttons]`

Data type: `buttondata`

Defines the push buttons to be displayed. Only one of the predefined buttons combination of type `buttondata` can be used. See [Predefined data on page 1563](#).

`[\BtnArray]`

Button Array

Data type: `string`

Own definition of push buttons stored in an array of strings. This function returns the array index when corresponding string is selected.

Only one of parameter `\Buttons` or `\BtnArray` can be used at the same time.

If none of the parameters `\Buttons` or `\BtnArray` or argument

`\Buttons :=btnNone` are used then the menu list reacts instantly to the user selection.

Max. 5 buttons with 42 characters each.

Continues on next page

[\`Icon`]

Data type: `icondata`

Defines the icon to be displayed. Only one of the predefined icons of type `icondata` can be used.

Default no icon. See [Predefined data on page 1563](#).

[\`DefaultIndex`]

Data type: `num`

The default user selection in the list menu corresponding to the index in the array specified in the parameter `ListItems`.

[\`MaxTime`]

Data type: `num`

The maximum amount of time in seconds that program execution waits. If no button is pressed or no selection is done within this time then the program continues to execute in the error handler unless the `BreakFlag` is used (see below). The constant `ERR_TP_MAXTIME` can be used to test whether or not the maximum time has elapsed.

[\`DIBreak`]

Digital Input Break

Data type: `signalDI`

The digital input signal that may interrupt the operator dialog. If no button is pressed or no selection is done before the signal is set to 1 (or is already 1) then the program continues to execute in the error handler, unless the `BreakFlag` is used (see below). The constant `ERR_TP_DIBREAK` can be used to test whether or not this has occurred.

[\`DIPassive`]

Digital Input Passive

Data type: `switch`

This switch overrides the default behavior when using `DIBreak` optional argument. Instead of reacting when signal is set to 1 (or already 1), the instruction should continue in the error handler (if no `BreakFlag` is used) when the signal `DIBreak` is set to 0 (or already is 0). The constant `ERR_TP_DIBREAK` can be used to test whether or not this has occurred.

[\`DOBreak`]()

Digital Output Break

Data type: `signalDO`

The digital output signal that may interrupt the operator dialog. If no button is pressed or no selection is done before the signal is set to 1 (or is already 1) then the program continues to execute in the error handler, unless the `BreakFlag` is used (see below). The constant `ERR_TP_DOBREAK` can be used to test whether or not this has occurred.

Continues on next page

2 Functions

2.215 UICollection - User List View

RobotWare Base

Continued

`[\DOPassive]`

Digital Output Passive

Data type: `switch`

This switch overrides the default behavior when using `DOBreak` optional argument. Instead of reacting when signal is set to 1 (or already 1), the instruction should continue in the error handler (if no `BreakFlag` is used) when the signal `DOBreak` is set to 0 (or already is 0). The constant `ERR_TP_DOBREAK` can be used to test whether or not this has occurred.

`[\PersBoolBreak]`

Persistent Boolean Break

Data type: `bool`

The persistent boolean that may interrupt the operator dialog. If no button is selected when the persistent boolean is set to `TRUE` (or is already `TRUE`) then the program continues to execute in the error handler unless the `BreakFlag` is used (see below). The constant `ERR_TP_PERSBOOLBREAK` can be used to test whether or not this has occurred.

`[\PersBoolPassive]`

Persistent Boolean Passive

Data type: `switch`

This switch overrides the default behavior when using `PersBoolBreak` optional argument. Instead of reacting when persistent boolean is set to `TRUE` (or already `TRUE`), the instruction should continue in the error handler (if no `BreakFlag` is used) when the persistent boolean `PersBoolBreak` is set to `FALSE` (or already is `FALSE`). The constant `ERR_TP_PERSBOOLBREAK` can be used to test whether or not this has occurred.

`[\BreakFlag]`

Data type: `errnum`

A variable that will hold the error code if `MaxTime`, `DIBreak`, `DOBreak`, or `PersBoolBreak` is used. If this optional variable is omitted then the error handler will be executed. The constants `ERR_TP_MAXTIME`, `ERR_TP_DIBREAK`, `ERR_TP_DOBREAK`, and `ERR_TP_PERSBOOLBREAK` can be used to select the reason.

`[\UIActiveSignal]`

Data type: `signaldo`

The digital output signal used in optional argument `UIActiveSignal` is set to 1 when the message box is activated on the FlexPendant. When the user selection has been done and the execution continue, the signal is set to 0 again.

No supervision of stop or restart exist. The signal is set to 0 when the function is ready, or when PP is moved.

Continues on next page

Program execution

The menu list with icon, header, list items, and default item are displayed according to the programmed arguments. Program execution waits until the operator has done the selection or the menu list is interrupted by time-out or signal action. The selected list item and interrupt reason are transferred back to the program.

New menu list on trap level takes focus from menu list on basic level.

Predefined data

icondata

The following constants of the data type `icondata` are predefined in the system:

Value	Constant	Icon
0	<code>iconNone</code>	No icon
1	<code>iconInfo</code>	Information icon
2	<code>iconWarning</code>	Warning icon
3	<code>iconError</code>	Error icon
4	<code>iconQuestion</code>	Question icon

buttondata

The following constants of the data type `buttondata` are predefined in the system.

Value	Constants	Button displayed
-1	<code>btnNone</code>	No button
0	<code>btnOK</code>	OK
1	<code>btnAbtrRtryIgn</code>	Abort, Retry and Ignore
2	<code>btnOKCancel</code>	OK and Cancel
3	<code>btnRetryCancel</code>	Retry and Cancel
4	<code>btnYesNo</code>	Yes and No
5	<code>btnYesNoCancel</code>	Yes, No and Cancel

It is possible to display user defined push buttons with the functions `UIMessageBox` and `UListView`.

btnres

The following constants of the data type `btnres` are predefined in the system.

Value	Constants	Button answer
0	<code>resUnkwn</code>	Unknown result
1	<code>resOK</code>	OK
2	<code>resAbort</code>	Abort
3	<code>resRetry</code>	Retry
4	<code>resIgnore</code>	Ignore
5	<code>resCancel</code>	Cancel
6	<code>resYes</code>	Yes

Continues on next page

2 Functions

2.215 UICollection - User List View

RobotWare Base

Continued

Value	Constants	Button answer
7	resNo	No

It is possible to work with user defined push buttons that answer with the functions `UICollection` and `UICollection`.

Error handling

The following recoverable errors are generated and can be handled in an error handler. The system variable `ERRNO` will be set to:

Name	Cause of error
<code>ERR_NO_ALIASIO_DEF</code>	The signal variable is a variable declared in RAPID and it has not been connected to an I/O signal defined in the I/O configuration with instruction <code>AliasIO</code> .
<code>ERR_TP_NO_CLIENT</code>	There is no client, for example, a <code>FlexPendant</code> , to take care of the instruction.
<code>ERR_UI_BUTTONS</code>	The argument <code>Buttons</code> of type <code>buttondata</code> has a not allowed value.
<code>ERR_UI_ICON</code>	The argument <code>Icon</code> of type <code>icondata</code> has a not allowed value.

If parameter `\BreakFlag` is not used, these situations can then be dealt with by the error handler:

- If there is a time-out (parameter `\MaxTime`) before an input from the operator, the system variable `ERRNO` is set to `ERR_TP_MAXTIME` and the execution continues in the error handler.
- If digital input is set (parameter `\DIBreak`) before an input from the operator, the system variable `ERRNO` is set to `ERR_TP_DIBREAK` and the execution continues in the error handler.
- If a digital output is set (parameter `\DOBreak`) before an input from the operator, the system variable `ERRNO` is set to `ERR_TP_DOBREAK` and the execution continues in the error handler.
- If a persistent boolean is set (parameter `\PersBoolBreak`) before an input from the operator then the system variable `ERRNO` is set to `ERR_TP_PERSBOOLBREAK` and the execution continues in the error handler.

More examples

The following example illustrates the function `UICollection`.

Example 1

```
CONST listitem list{2} := [ ["", "Calibrate tool1"], ["", "Calibrate tool2"] ];
VAR num list_item;
VAR errnum err_var;
...
list_item := UICollection
( \Header:="Select tool ?",
  list \Icon:=iconInfo
  \MaxTime:=60
```

Continues on next page

```

\DIBreak:=di5
\BreakFlag:=err_var);
TEST err_var
CASE ERR_TP_MAXTIME:
CASE ERR_TP_DIBREAK:
    ! No operator answer
CASE 0:
    ! Operator answer
    IF list_item =1 THEN
        ! Calibrate tool1
    ELSEIF list_item=2 THEN
        ! Calibrate tool2
    ENDIF
DEFAULT:
    ! Not such case defined
ENDTEST

```

The message box is displayed and the operator can select an item in the list. The message box can also be interrupted with time out or break by digital input signal. In the program it's possible to find out the reason and take the appropriate action.

Limitations

Avoid using too small a value for the time-out parameter `\MaxTime` when `UListView` is frequently executed, for example in a loop. It can result in unpredictable behavior from the system performance, like slow response of the FlexPendant.

Syntax

```

UListView '('
    [['\ Result ']:= <var or pers (INOUT) of btnres>]
    [['\ Header ']:= <expression (IN) of string>] ','
    [ListItems '='] <array {*} (IN) of listitem>
    [['\ Buttons ']:= <expression (IN) of buttondata>]
    | [['\ BtnArray ']:= <array {*} (IN) of string>]
    [['\ Icon ']:= <expression (IN) of icondata>]
    [['\ DefaultIndex ']:= <expression (IN) of num>]
    [['\ MaxTime ']:= <expression (IN) of num>]
    [['\ DIBreak ']:= <variable (VAR) of signaldi>]
    [['\ DIPassive]
    [['\ DOBreak ']:= <variable (VAR) of signaldo>]
    [['\ DOPassive]
    [['\ PersBoolBreak ']:= <persistent (PERS) of bool>]
    [['\ PersBoolPassive]
    [['\ BreakFlag ']:= <var or pers (INOUT) of errnum>]
    [['\ UIActiveSignal ']:= <variable (VAR) of signaldo>] ')'

```

A function with return value of the data type `num`.

Continues on next page

2 Functions

2.215 UICollection - User List View

RobotWare Base

Continued

Related information

For information about	See
Icon display data	icondata - Icon display data on page 1671
Push button data	buttondata - Push button data on page 1604
Push button result data	btnres - Push button result data on page 1601
List item data structure	listitem - List item data structure on page 1681
User interaction message box type basic	UIMsgBox - User Message Dialog Box type basic on page 992
User interaction message box type advanced	UIMessageBox - User Message Box type advanced on page 1567
User interaction number entry	UINumEntry - User Number Entry on page 1576
User interaction number tune	UINumTune - User Number Tune on page 1583
User interaction alpha entry	UIAlphaEntry - User Alpha Entry on page 1536
System connected to FlexPendant etc.	UIClientExist - Exist User Client on page 1543
Clean up the operator window	TPErase - Erases text printed on the FlexPendant on page 865

2.216 UIMessageBox - User Message Box type advanced

Usage

UIMessageBox (*User Interaction Message Box*) is used to communicate with the user of the robot system on available user device, such as the FlexPendant. A message is written to the operator, who answers by selecting a button. The user selection is then transferred back to the program.

Basic examples

The following example illustrates the function UIMessageBox.

See also [More examples on page 1573](#).

Example 1

```

VAR btnres answer;
CONST string my_message{5}:= ["Message Line 1","Message Line 2",
    "Message Line 3","Message Line 4","Message Line 5"];
CONST string my_buttons{2}:=["OK","Skip"];
...
answer:= UIMessageBox (
    \Header:="UIMessageBox Header"
    \MsgArray:=my_message
    \BtnArray:=my_buttons
    \Icon:=iconInfo);
IF answer = 1 THEN
    ! Operator selection OK
ELSEIF answer = 2 THEN
    ! Operator selection Skip
ELSE
    ! No such case defined
ENDIF

```

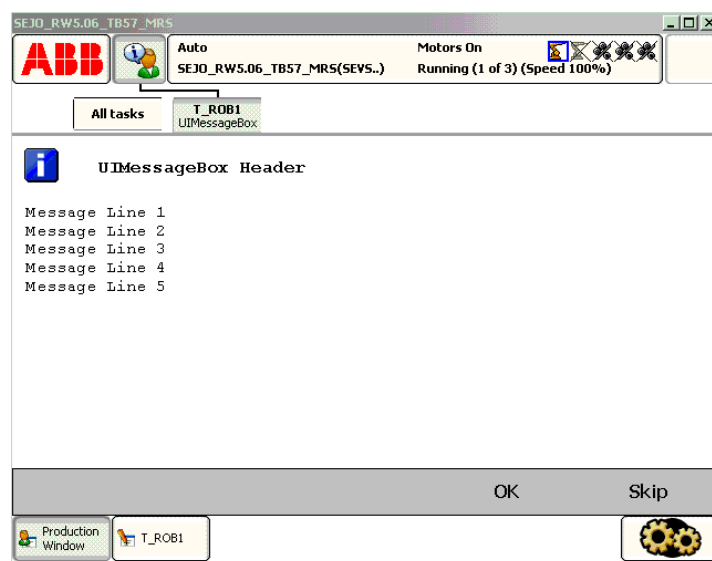

xx0500002409

Continues on next page

2 Functions

2.216 UIMessageBox - User Message Box type advanced

RobotWare Base

Continued

The message box is with icon, header, message, and user defined push buttons are shown on the FlexPendant. Program execution waits until OK or Skip is pressed. In other words, `answer` will be assigned 1 (OK) or 2 (Skip) depending on which of the buttons is pressed (corresponding array index).



Note

Message Line 1 to Message Line 5 are displayed on separate lines 1 to 5 (the switch `\Wrap` is not used).

Example 2

```
VAR btnres answer;  
...  
answer := UIMessageBox (\Header:= "Critical Error"  
\Message:="Move the program pointer to continue."  
\Buttons:=btnNone);
```

This example will result in a dialog that will stay open until the operator moves the program pointer.

Return value

Data type: `btnres`

The numeric value of the button that is selected from the message box.

If argument `\Buttons` is used, the predefined symbolic constants of type `btnres` is returned.

If argument `\BtnArray` is used, the corresponding array index is returned.

If function breaks via `\BreakFlag` or if `\Buttons:=btnNone`:

- If parameter `\DefaultBtn` is specified, this index is returned.
- If parameter `\DefaultBtn` is not specified, `resUnkwn` equal to 0 is returned.

If function breaks via `ERROR` handler, there is no return value at all.

Arguments

```
UIMessageBox ( [\Header] [\Message] | [\MsgArray] [\Wrap][\Buttons]  
| [\BtnArray] [\DefaultBtn] [\Icon][\Image] [\MaxTime]  
[\DIBreak] [\DIPassive] [\DOBreak] [\DOPassive]  
[\PersBoolBreak] [\PersBoolPassive] [\BreakFlag]  
[\UIActiveSignal])
```

`[\Header]`

Data type: `string`

Header text to be written at the top of the message box. Max. 40 characters.

`[\Message]`

Data type: `string`

One text line to be written on the display. Max 55 characters.

`[\MsgArray]`

Message Array

Continues on next page

Data type: string

Several text lines from an array to be written on the display.

Only one of parameters `\Message` or `\MsgArray` can be used at the same time.

Max. layout space is 11 lines with 55 characters.

[`\Wrap`]

Data type: switch

If selected, all the specified strings in the argument `\MsgArray` will be concatenated to one string with single spaces between each individual string and spread out on as few lines as possible.

Default, each string in the argument `\MsgArray` will be on separate line on the display.

[`\Buttons`]

Data type: buttondata

Defines the push buttons to be displayed. Only one of the predefined buttons combination of type `buttondata` can be used. See [Predefined data on page 1572](#).

Default, the system displays the OK button.

[`\BtnArray`]

Button Array

Data type: string

Own definition of push buttons stored in an array of strings. This function returns the array index when corresponding string is selected.

Only one of parameter `\Buttons` or `\BtnArray` can be used at the same time.

Max. 5 buttons with 42 characters each.

[`\DefaultBtn`]

Default Button

Data type: btnres

Allows to specify a value that should be returned if the message box is interrupted by `\MaxTime`, `\DIBreak`, or `\DOBreak`. It is possible to specify the predefined symbolic constant of type `btnres` or any user defined value. See [Predefined data on page 1572](#).

[`\Icon`]

Data type: icondata

Defines the icon to be displayed. Only one of the predefined icons of type `icondata` can be used. See [Predefined data on page 1572](#).

Default, no icon.

[`\Image`]

Data type: string

The name of the image that should be used. To launch own images, the images has to be placed in the `HOME:` directory in the active system or directly in the active system.

Continues on next page

2 Functions

2.216 UIMessageBox - User Message Box type advanced

RobotWare Base

Continued

The recommendation is to place the files in the `HOME:` directory so that they are saved if a Backup and Restore is done.

A **Restart** is required and then the FlexPendant loads the images.

The RobotWare option *FlexPendant Interface* is required.

The image can have the width of 185 pixels and the height of 300 pixels. If the image is bigger, only 185x300 pixels of the image are shown, starting at the top left of the image.

No exact value can be specified on the file size for an image or the number of images that can be loaded to the FlexPendant. It depends on the size of other files loaded to the FlexPendant. The program execution will continue if an image is used that has not been loaded to the FlexPendant.

[\MaxTime]

Data type: num

The maximum amount of time in seconds that program execution waits. If no button is selected within this time, the program continues to execute in the error handler unless the `BreakFlag` is used (see below). The constant `ERR_TP_MAXTIME` can be used to test whether or not the maximum time has elapsed.

[\DIBreak]

Digital Input Break

Data type: signaldi

The digital input signal that may interrupt the operator dialog. If no button is selected when the signal is set to 1 (or is already 1) then the program continues to execute in the error handler, unless the `BreakFlag` is used (see below). The constant `ERR_TP_DIBREAK` can be used to test whether or not this has occurred.

[\DIPassive]

Digital Input Passive

Data type: switch

This switch overrides the default behavior when using `DIBreak` optional argument. Instead of reacting when signal is set to 1 (or already 1), the instruction should continue in the error handler (if no `BreakFlag` is used) when the signal `DIBreak` is set to 0 (or already is 0). The constant `ERR_TP_DIBREAK` can be used to test whether or not this has occurred.

[\DOBreak]

Digital Output Break

Data type: signaldo

The digital output signal that may interrupt the operator dialog. If no button is selected when the signal is set to 1 (or is already 1) then the program continues to execute in the error handler, unless the `BreakFlag` is used (see below). The constant `ERR_TP_DOBREAK` can be used to test whether or not this has occurred.

[\DOPassive]

Digital Output Passive

Data type: switch

Continues on next page

This switch overrides the default behavior when using `DOBreak` optional argument. Instead of reacting when signal is set to 1 (or already 1), the instruction should continue in the error handler (if no `BreakFlag` is used) when the signal `DOBreak` is set to 0 (or already is 0). The constant `ERR_TP_DOBREAK` can be used to test whether or not this has occurred.

`[\PersBoolBreak]`

Persistent Boolean Break

Data type: `bool`

The persistent boolean that may interrupt the operator dialog. If no button is selected when the persistent boolean is set to `TRUE` (or is already `TRUE`) then the program continues to execute in the error handler unless the `BreakFlag` is used (see below). The constant `ERR_TP_PERSBOOLBREAK` can be used to test whether or not this has occurred.

`[\PersBoolPassive]`

Persistent Boolean Passive

Data type: `switch`

This switch overrides the default behavior when using `PersBoolBreak` optional argument. Instead of reacting when persistent boolean is set to `TRUE` (or already `TRUE`), the instruction should continue in the error handler (if no `BreakFlag` is used) when the persistent boolean `PersBoolBreak` is set to `FALSE` (or already is `FALSE`). The constant `ERR_TP_PERSBOOLBREAK` can be used to test whether or not this has occurred.

`[\BreakFlag]`

Data type: `errnum`

A variable that will hold the error code if `MaxTime`, `DIBreak`, `DOBreak`, or `PersBoolBreak` is used. If this optional variable is omitted then the error handler will be executed. The constants `ERR_TP_MAXTIME`, `ERR_TP_DIBREAK`, `ERR_TP_DOBREAK`, and `ERR_TP_PERSBOOLBREAK` can be used to select the reason.

`[\UIActiveSignal]`

Data type: `signaldo`

The digital output signal used in optional argument `UIActiveSignal` is set to 1 when the message box is activated on the FlexPendant. When the user selection has been done and the execution continue, the signal is set to 0 again.

No supervision of stop or restart exist. The signal is set to 0 when the function is ready, or when PP is moved.

Program execution

The message box with icon, header, message lines, image, and buttons are displayed according to the programmed arguments. Program execution waits until the user selects one button or the message box is interrupted by time-out or signal action. The user selection and interrupt reason are transferred back to the program.

New message box on trap level takes the focus from the message box on the basic level.

Continues on next page

2 Functions

2.216 UIAlertView - User Message Box type advanced

RobotWare Base

Continued

Predefined data

icondata

The following constants of the data type `icondata` are predefined in the system:

Value	Constant	Icon
0	<code>iconNone</code>	No icon
1	<code>iconInfo</code>	Information icon
2	<code>iconWarning</code>	Warning icon
3	<code>iconError</code>	Error icon
4	<code>iconQuestion</code>	Question icon

buttondata

The following constants of the data type `buttondata` are predefined in the system.

Value	Constants	Button displayed
-1	<code>btnNone</code>	No button
0	<code>btnOK</code>	OK
1	<code>btnAbtrRtryIgn</code>	Abort, Retry and Ignore
2	<code>btnOKCancel</code>	OK and Cancel
3	<code>btnRetryCancel</code>	Retry and Cancel
4	<code>btnYesNo</code>	Yes and No
5	<code>btnYesNoCancel</code>	Yes, No and Cancel

It is possible to display user defined push buttons with the functions `UIAlertView` and `UIListView`.

btnres

The following constants of the data type `btnres` are predefined in the system.

Value	Constants	Button answer
0	<code>resUnkwn</code>	Unknown result
1	<code>resOK</code>	OK
2	<code>resAbort</code>	Abort
3	<code>resRetry</code>	Retry
4	<code>resIgnore</code>	Ignore
5	<code>resCancel</code>	Cancel
6	<code>resYes</code>	Yes
7	<code>resNo</code>	No

It is possible to work with user defined push buttons that answer with the functions `UIAlertView` and `UIListView`.

Continues on next page

Error handling

The following recoverable errors are generated and can be handled in an error handler. The system variable `ERRNO` will be set to:

Name	Cause of error
<code>ERR_NO_ALIASIO_DEF</code>	The signal variable is a variable declared in RAPID and it has not been connected to an I/O signal defined in the I/O configuration with instruction <code>AliasIO</code> .
<code>ERR_TP_NO_CLIENT</code>	There is no client, for example, a FlexPendant, to take care of the instruction.
<code>ERR_UI_BUTTONS</code>	The argument <code>Buttons</code> of type <code>buttondata</code> has a not allowed value.
<code>ERR_UI_ICON</code>	The argument <code>Icon</code> of type <code>icondata</code> has a not allowed value.

If parameter `\BreakFlag` is not used, these situations can then be dealt with by the error handler:

- If there is a time-out (parameter `\MaxTime`) before an input from the operator, the system variable `ERRNO` is set to `ERR_TP_MAXTIME` and the execution continues in the error handler.
- If digital input is set (parameter `\DIBreak`) before an input from the operator, the system variable `ERRNO` is set to `ERR_TP_DIBREAK` and the execution continues in the error handler.
- If a digital output is set (parameter `\DOBreak`) before an input from the operator, the system variable `ERRNO` is set to `ERR_TP_DOBREAK` and the execution continues in the error handler.
- If a persistent boolean is set (parameter `\PersBoolBreak`) before an input from the operator then the system variable `ERRNO` is set to `ERR_TP_PERSBOOLBREAK` and the execution continues in the error handler.

More examples

The following example illustrates the function `UIMessageBox`.

Example 1

```

VAR errnum err_var;
VAR btnres answer;
...
answer := UIMessageBox (\Header:= "Cycle step 3"
  \Message:="Continue with the calibration ?" \Buttons:=btnOKCancel
  \DefaultBtn:=resCancel \Icon:=iconInfo \MaxTime:=60 \DIBreak:=di5
  \BreakFlag:=err_var);
IF answer = resOK THEN
  ! OK from the operator
ELSE
  ! Cancel from the operator or operation break
TEST err_var
CASE ERR_TP_MAXTIME:
  ! Time out

```

Continues on next page

2 Functions

2.216 UIMessageBox - User Message Box type advanced

RobotWare Base

Continued

```
CASE ERR_TP_DIBREAK:
    ! Input signal break
DEFAULT:
    ! Not such case defined
ENDTEST
ENDIF
```

The message box is displayed, and the operator can answer OK or Cancel. The message box can also be interrupted with time out or break by digital input signal. In the program it's possible to find out the reason.

Limitations

Avoid using too small a value for the time-out parameter `\MaxTime` when `UIMessageBox` is frequently executed, for example in a loop. It can result in an unpredictable behavior of the system performance, like slow response of the `FlexPendant`.

Syntax

```
UIMessageBox '('
  ['\' Header :=' <expression (IN) of string>] ','
  ['\' Message :=' <expression (IN) of string>]
  | ['\' MsgArray :=' <array {*} (IN) of string>]
  ['\' Wrap]
  ['\' Buttons :=' <expression (IN) of buttondata>]
  | ['\' BtnArray :=' <array {*} (IN) of string>]
  ['\' DefaultBtn :=' <expression (IN) of btnres>]
  ['\' Icon :=' <expression (IN) of icondata>]
  ['\' Image :=' <expression (IN) of string>]
  ['\' MaxTime :=' <expression (IN) of num>]
  ['\' DIBreak :=' <variable (VAR) of signaldi>]
  ['\' DIPassive]
  ['\' DOBreak :=' <variable (VAR) of signaldo>]
  ['\' DOPassive]
  ['\' PersBoolBreak :=' <persistent (PERS) of bool>]
  ['\' PersBoolPassive]
  ['\' BreakFlag :=' <var or pers (INOUT) of errnum>]
  ['\' UIActiveSignal :=' <variable (VAR) of signaldo>] ')''
```

A function with return value of the data type `btnres`.

Related information

For information about	See
Icon display data	icondata - Icon display data on page 1671
Push button data	buttondata - Push button data on page 1604
Push button result data	btnres - Push button result data on page 1601
User interaction message box type basic	UIMsgBox - User Message Dialog Box type basic on page 992
User interaction number entry	UINumEntry - User Number Entry on page 1576
User interaction number tune	UINumTune - User Number Tune on page 1583

Continues on next page

For information about	See
User interaction alpha entry	UIAlphaEntry - User Alpha Entry on page 1536
User interaction list view	UIListView - User List View on page 1558
System connected to FlexPendant etc.	UIClientExist - Exist User Client on page 1543
<i>FlexPendant interface</i>	<i>Product specification - Controller software IRC5</i>
Clean up the operator window	TPErase - Erases text printed on the FlexPendant on page 865

2 Functions

2.217 UINumEntry - User Number Entry

RobotWare Base

2.217 UINumEntry - User Number Entry

Usage

`UINumEntry` (*User Interaction Number Entry*) is used to let the operator enter a numeric value from the available user device, such as the FlexPendant. A message is written to the operator, who answers with a numeric value. The numeric value is then checked, approved and transferred back to the program.

Basic examples

The following example illustrates the function `UINumEntry`.

See also [More examples on page 1581](#).

Example 1

```
VAR num answer;  
...  
answer := UINumEntry(  
  \Header:="UINumEntry Header"  
  \Message:="How many units should be produced?"  
  \Icon:=iconInfo  
  \InitValue:=5  
  \MinValue:=1  
  \MaxValue:=10  
  \AsInteger);  
FOR i FROM 1 TO answer DO  
  produce_part;  
ENDFOR
```

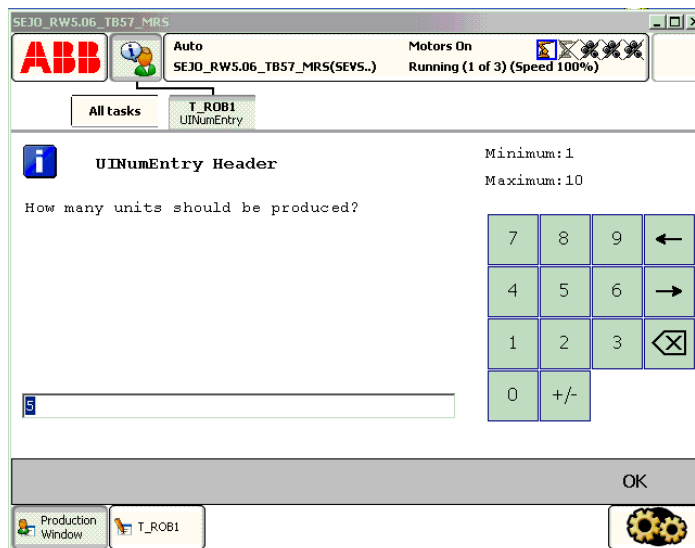

xx0500002412

The numeric message box with icon, header, message, initial, maximum, and minimum values are shown on the FlexPendant. The message box checks that the operator selects an integer within the value range. Program execution waits until OK is pressed and then the selected numerical value is returned. The routine `produce_part` is then repeated the number of input times via the FlexPendant.

Continues on next page

Return value

Data type: num

This function returns the input numeric value.

If function breaks via `\BreakFlag`:

- If parameter `\InitValue` is specified, this value is returned
- If parameter `\InitValue` is not specified, value 0 is returned.

If function breaks via `ERROR` handler, no return value at all.

Arguments

```
UINumEntry ( [\Header] [\Message] | [\MsgArray]
             [\Wrap][\Icon][\InitValue] [\MinValue] [\MaxValue]
             [\AsInteger][\MaxTime] [\DIBreak] [\DIPassive] [\DOBreak]
             [\DOPassive] [\PersBoolBreak] [\PersBoolPassive] [\BreakFlag]
             [\UIActiveSignal])
```

`[\Header]`

Data type: string

Header text to be written at the top of the message box. Max. 40 characters.

`[\Message]`

Data type: string

One text line to be written on the display. Max. 40 characters.

`[\MsgArray]`

Message Array

Data type: string

Several text lines from an array to be written on the display.

Only one of parameters `\Message` or `\MsgArray` can be used at the same time.

Max. layout space is 9 lines with 40 characters.

`[\Wrap]`

Data type: switch

If selected, all the specified strings in the argument `\MsgArray` will be concatenated to one string with a single space between each individual string, and spread out on as few lines as possible.

Default, each string in the argument `\MsgArray` will be on a separate line on the display.

`[\Icon]`

Data type: icondata

Defines the icon to be displayed. Only one of the predefined icons of type `icondata` can be used. See [Predefined data on page 1580](#).

Default no icon.

`[\InitValue]`

Data type: num

Initial value that is displayed in the entry box.

Continues on next page

2 Functions

2.217 UINumEntry - User Number Entry

RobotWare Base

Continued

[\MinValue]

Data type: num

The minimum value for the return value.

[\MaxValue]

Data type: num

The maximum value for the return value.

[\AsInteger]

Data type: switch

Eliminates the decimal point from the number pad to ensure that the return value is an integer.

[\MaxTime]

Data type: num

The maximum amount of time in seconds that program execution waits. If the OK button is not pressed within this time, the program continues to execute in the error handler unless the `BreakFlag` is used (see below). The constant `ERR_TP_MAXTIME` can be used to test whether or not the maximum time has elapsed.

[\DIBreak]

Digital Input Break

Data type: signaldi

The digital input signal that may interrupt the operator dialog. If the OK button is not pressed before the signal is set to 1 (or is already 1) then the program continues to execute in the error handler, unless the `BreakFlag` is used (see below). The constant `ERR_TP_DIBREAK` can be used to test whether or not this has occurred.

[\DIPassive]

Digital Input Passive

Data type: switch

This switch overrides the default behavior when using `DIBreak` optional argument. Instead of reacting when signal is set to 1 (or already 1), the instruction should continue in the error handler (if no `BreakFlag` is used) when the signal `DIBreak` is set to 0 (or already is 0). The constant `ERR_TP_DIBREAK` can be used to test whether or not this has occurred.

[\DOBreak]

Digital Output Break

Data type: signaldo

The digital output signal that may interrupt the operator dialog. If the OK button is not pressed before the signal is set to 1 (or is already 1) then the program continues to execute in the error handler, unless the `BreakFlag` is used (see below). The constant `ERR_TP_DOBREAK` can be used to test whether or not this has occurred.

Continues on next page

`[\DOPassive]`

Digital Output Passive

Data type: `switch`

This switch overrides the default behavior when using `DOBreak` optional argument. Instead of reacting when signal is set to 1 (or already 1), the instruction should continue in the error handler (if no `BreakFlag` is used) when the signal `DOBreak` is set to 0 (or already is 0). The constant `ERR_TP_DOBREAK` can be used to test whether or not this has occurred.

`[\PersBoolBreak]`

Persistent Boolean Break

Data type: `bool`

The persistent boolean that may interrupt the operator dialog. If no button is selected when the persistent boolean is set to `TRUE` (or is already `TRUE`) then the program continues to execute in the error handler unless the `BreakFlag` is used (see below). The constant `ERR_TP_PERSBOOLBREAK` can be used to test whether or not this has occurred.

`[\PersBoolPassive]`

Persistent Boolean Passive

Data type: `switch`

This switch overrides the default behavior when using `PersBoolBreak` optional argument. Instead of reacting when persistent boolean is set to `TRUE` (or already `TRUE`), the instruction should continue in the error handler (if no `BreakFlag` is used) when the persistent boolean `PersBoolBreak` is set to `FALSE` (or already is `FALSE`). The constant `ERR_TP_PERSBOOLBREAK` can be used to test whether or not this has occurred.

`[\BreakFlag]`

Data type: `errnum`

A variable that will hold the error code if `MaxTime`, `DIBreak`, `DOBreak`, or `PersBoolBreak` is used. If this optional variable is omitted then the error handler will be executed. The constants `ERR_TP_MAXTIME`, `ERR_TP_DIBREAK`, `ERR_TP_DOBREAK`, and `ERR_TP_PERSBOOLBREAK` can be used to select the reason.

`[\UIActiveSignal]`

Data type: `signaldo`

The digital output signal used in optional argument `UIActiveSignal` is set to 1 when the message box is activated on the FlexPendant. When the user selection has been done and the execution continue, the signal is set to 0 again.

No supervision of stop or restart exist. The signal is set to 0 when the function is ready, or when PP is moved.

Continues on next page

2 Functions

2.217 UINumEntry - User Number Entry

RobotWare Base

Continued

Program execution

The numeric message box with numeric pad, icon, header, message lines, init-, max-, and minvalue are displayed according to the programmed arguments. Program execution waits until the user has entered an approved numeric value and presses OK or the message box is interrupted by time-out or signal action. The input numeric value and interrupt reason are transferred back to the program. New message box on trap level takes the focus from the message box on the basic level.

Predefined data

The following constants of the data type `icondata` are predefined in the system:

Value	Constant	Icon
0	<code>iconNone</code>	No icon
1	<code>iconInfo</code>	Information icon
2	<code>iconWarning</code>	Warning icon
3	<code>iconError</code>	Error icon
4	<code>iconQuestion</code>	Question icon

Error handling

The following recoverable errors are generated and can be handled in an error handler. The system variable `ERRNO` will be set to:

Name	Cause of error
<code>ERR_NO_ALIASIO_DEF</code>	The signal variable is a variable declared in RAPID and it has not been connected to an I/O signal defined in the I/O configuration with instruction <code>AliasIO</code> .
<code>ERR_TP_NO_CLIENT</code>	There is no client, for example, a FlexPendant, to take care of the instruction.
<code>ERR_UI_ICON</code>	The argument <code>Icon</code> of type <code>icondata</code> has a not allowed value.
<code>ERR_UI_INITVALUE</code>	The initial value (parameter <code>\InitValue</code>) is not specified within the range of the minimum and maximum value (parameters <code>\MinValue</code> and <code>\MaxValue</code>).
<code>ERR_UI_MAXMIN</code>	The minimum value (parameter <code>\MinValue</code>) is greater than the maximum value (parameter <code>\MaxValue</code>).
<code>ERR_UI_NOTINT</code>	The initial value (parameter <code>\InitValue</code>) is not an integer as specified in the parameter <code>\AsInteger</code> .

If parameter `\BreakFlag` is not used, these situations can then be dealt with by the error handler:

- If there is a time-out (parameter `\MaxTime`) before an input from the operator then the system variable `ERRNO` is set to `ERR_TP_MAXTIME` and the execution continues in the error handler.
- If digital input is set (parameter `\DIBreak`) before an input from the operator then the system variable `ERRNO` is set to `ERR_TP_DIBREAK` and the execution continues in the error handler.

Continues on next page

- If a digital output is set (parameter `\DOBreak`) before an input from the operator then the system variable `ERRNO` is set to `ERR_TP_DOBREAK` and the execution continues in the error handler.
- If a persistent boolean is set (parameter `\PersBoolBreak`) before an input from the operator then the system variable `ERRNO` is set to `ERR_TP_PERSBOOLBREAK` and the execution continues in the error handler.

More examples

The following example illustrates the function `UINumEntry`.

Example 1

```

VAR errnum err_var;
VAR num answer;
VAR num distance;
...
answer := UINumEntry (\Header:= "BWD move on path"
  \Message:="Enter the path overlap ?" \Icon:=iconInfo
  \InitValue:=5 \MinValue:=0 \MaxValue:=10
  \MaxTime:=60 \DIBreak:=di5 \BreakFlag:=err_var);
TEST err_var
CASE ERR_TP_MAXTIME:
CASE ERR_TP_DIBREAK:
  ! No operator answer distance := 5;
CASE 0
  ! Operator answer
  distance := answer;
DEFAULT:
  ! Not such case defined
ENDTEST

```

The message box is displayed and the operator can enter a numeric value and press OK. The message box can also be interrupted with a time out or break by digital input signal. In the program it's possible to find out the reason and take the appropriate action.

Limitations

Avoid using too small a value for the time-out parameter `\MaxTime` when `UINumEntry` is frequently executed, for example in a loop. It can result in unpredictable behavior from the system performance, like slow response of the FlexPendant.

Syntax

```

UINumEntry '('
  ['\ ' Header :=' <expression (IN) of string>]
  [Message :=' <expression (IN) of string > ]
  | ['\ ' MsgArray :=' <array {*} (IN) of string>]
  ['\ ' Wrap]
  ['\ ' Icon :=' <expression (IN) of icondata>]
  ['\ ' InitValue :=' <expression (IN) of dnum>]
  ['\ ' MinValue :=' <expression (IN) of dnum>]

```

Continues on next page

2 Functions

2.217 UINumEntry - User Number Entry

RobotWare Base

Continued

```
['\' MaxValue ':=' <expression (IN) of dnum>]  
['\' AsInteger]  
['\' MaxTime ':=' <expression (IN) of num>]  
['\' DIBreak ':=' <variable (VAR) of signaldi>]  
['\' DIPassive]  
['\' DOBreak ':=' <variable (VAR) of signaldo>]  
['\' DOPassive]  
['\' PersBoolBreak ':=' <persistent (PERS) of bool>]  
['\' PersBoolPassive]  
['\' BreakFlag ':=' <var or pers (INOUT) of errnum>]  
['\' UIActiveSignal ':=' <variable (VAR) of signaldo>] ''
```

A function with return value of the data type num.

Related information

For information about	See
Icon display data	icondata - Icon display data on page 1671
User interaction message box type basic	UIMsgBox - User Message Dialog Box type basic on page 992
User interaction message box type advanced	UIMessageBox - User Message Box type advanced on page 1567
User interaction number tune	UINumTune - User Number Tune on page 1583
User interaction alpha entry	UIAlphaEntry - User Alpha Entry on page 1536
User interaction list view	UIListView - User List View on page 1558
System connected to FlexPendant etc.	UIClientExist - Exist User Client on page 1543
Clean up the operator window	TPErase - Erases text printed on the Flex-Pendant on page 865

2.218 UINumTune - User Number Tune

Usage

UINumTune (*User Interaction Number Tune*) is used to let the operator tune a numeric value from the available user device, such as the FlexPendant. A message is written to the operator, who tunes a numeric value. The tuned numeric value is then checked, approved and transferred back to the program.

Basic examples

The following example illustrates the function UINumTune.

See also [More examples on page 1587](#).

Example 1

```
VAR num flow;
...
flow := UINumTune(
  \Header:="UINumTune Header"
  \Message:="Tune the flow?"
  \Icon:=iconInfo,
  2.5,
  0.1
  \MinValue:=1.5
  \MaxValue:=3.5);
```

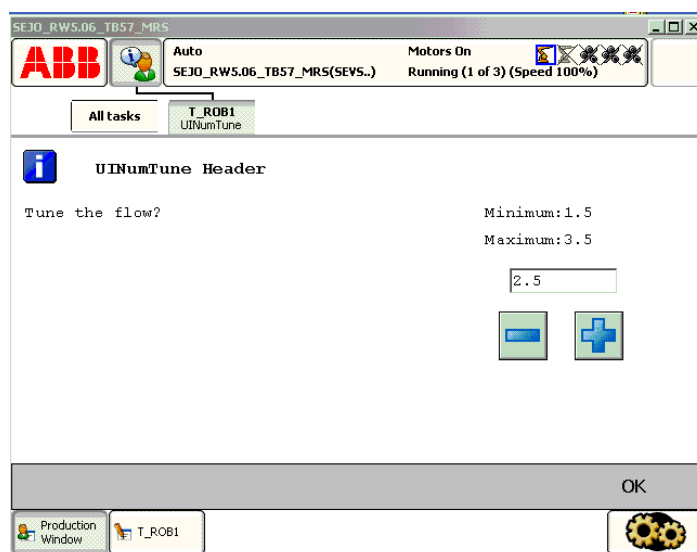

xx0500002414

The numeric tune message box with icon, header, message, initial, increment, maximum, and minimum values are shown on the FlexPendant. The message box checks that the operator tunes the flow value with step 0.1 from the initial value 2.5, within the value range 1.5-3.5. Program execution waits until OK is pressed and then the selected numerical value is returned and stored in the variable flow.

Return value

Data type: num

Continues on next page

2 Functions

2.218 UINumTune - User Number Tune

RobotWare Base

Continued

This function returns the tuned numeric value.

If function breaks via `\BreakFlag`, the specified `\InitValue` is returned.

If function breaks via `ERROR` handler, no return value is returned at all.

Arguments

```
UINumTune ( [\Header] [\Message] | [\MsgArray] [\Wrap] [\Icon]  
            InitValue Increment [\MinValue] [\MaxValue] [\MaxTime]  
            [\DIBreak] [\DIPassive] [\DOBreak] [\DOPassive]  
            [\PersBoolBreak] [\PersBoolPassive] [\BreakFlag]  
            [\UIActiveSignal])
```

`[\Header]`

Data type: `string`

Header text to be written at the top of the message box. Max. 40 characters.

`[\Message]`

Data type: `string`

One text line to be written on the display. Max. 40 characters.

`[\MsgArray]`

Message Array

Data type: `string`

Several text lines from an array to be written on the display.

Only one of parameters `\Message` or `\MsgArray` can be used at the same time.

Max. layout space is 9 lines with 40 characters.

`[\Wrap]`

Data type: `switch`

If selected, all the specified strings in the argument `\MsgArray` will be concatenated to one string with a single space between each individual string, and spread out on as few lines as possible.

Default, each string in the argument `\MsgArray` will be on a separate line on the display.

`[\Icon]`

Data type: `icondata`

Defines the icon to be displayed. Only one of the predefined icons of type `icondata` can be used. See [Predefined data on page 1587](#).

Default no icon.

`InitValue`

Data type: `num`

Initial value that is displayed in the entry box.

`Increment`

Data type: `num`

This parameter specifies how much the value should change when the plus or minus button is pressed.

Continues on next page

[\MinValue]

Data type: num

The minimum value for the return value.

[\MaxValue]

Data type: num

The maximum value for the return value.

[\MaxTime]

Data type: num

The maximum amount of time in seconds that program execution waits. If the OK button is not pressed within this time, the program continues to execute in the error handler unless the `BreakFlag` is used (see below). The constant `ERR_TP_MAXTIME` can be used to test whether or not the maximum time has elapsed.

[\DIBreak]

Digital Input Break

Data type: signaldi

The digital input signal that may interrupt the operator dialog. If the OK button is not pressed before the signal is set to 1 (or is already 1) then the program continues to execute in the error handler, unless the `BreakFlag` is used (see below). The constant `ERR_TP_DIBREAK` can be used to test whether or not this has occurred.

[\DIPassive]

Digital Input Passive

Data type: switch

This switch overrides the default behavior when using `DIBreak` optional argument. Instead of reacting when signal is set to 1 (or already 1), the instruction should continue in the error handler (if no `BreakFlag` is used) when the signal `DIBreak` is set to 0 (or already is 0). The constant `ERR_TP_DIBREAK` can be used to test whether or not this has occurred.

[\DOBreak]

Digital Output Break

Data type: signaldo

The digital output signal that may interrupt the operator dialog. If the OK button is not pressed before the signal is set to 1 (or is already 1) then the program continues to execute in the error handler, unless the `BreakFlag` is used (see below). The constant `ERR_TP_DOBREAK` can be used to test whether or not this has occurred.

[\DOPassive]

Digital Output Passive

Data type: switch

This switch overrides the default behavior when using `DOBreak` optional argument. Instead of reacting when signal is set to 1 (or already 1), the instruction should continue in the error handler (if no `BreakFlag` is used) when the signal `DOBreak`

Continues on next page

2 Functions

2.218 UINumTune - User Number Tune

RobotWare Base

Continued

is set to 0 (or already is 0). The constant `ERR_TP_DOBREAK` can be used to test whether or not this has occurred.

`[\PersBoolBreak]`

Persistent Boolean Break

Data type: `bool`

The persistent boolean that may interrupt the operator dialog. If no button is selected when the persistent boolean is set to `TRUE` (or is already `TRUE`) then the program continues to execute in the error handler unless the `BreakFlag` is used (see below). The constant `ERR_TP_PERSBOOLBREAK` can be used to test whether or not this has occurred.

`[\PersBoolPassive]`

Persistent Boolean Passive

Data type: `switch`

This switch overrides the default behavior when using `PersBoolBreak` optional argument. Instead of reacting when persistent boolean is set to `TRUE` (or already `TRUE`), the instruction should continue in the error handler (if no `BreakFlag` is used) when the persistent boolean `PersBoolBreak` is set to `FALSE` (or already is `FALSE`). The constant `ERR_TP_PERSBOOLBREAK` can be used to test whether or not this has occurred.

`[\BreakFlag]`

Data type: `errnum`

A variable that will hold the error code if `MaxTime`, `DIBreak`, `DOBreak`, or `PersBoolBreak` is used. If this optional variable is omitted then the error handler will be executed. The constants `ERR_TP_MAXTIME`, `ERR_TP_DIBREAK`, `ERR_TP_DOBREAK`, and `ERR_TP_PERSBOOLBREAK` can be used to select the reason.

`[\UIActiveSignal]`

Data type: `signaldo`

The digital output signal used in optional argument `UIActiveSignal` is set to 1 when the message box is activated on the FlexPendant. When the user selection has been done and the execution continue, the signal is set to 0 again.

No supervision of stop or restart exist. The signal is set to 0 when the function is ready, or when PP is moved.

Program execution

The numeric tune message box with tune +/- buttons, icon, header, message lines, init-, increment, max, and minvalue are displayed according to the programmed arguments. Program execution waits until the user has tuned the numeric value and pressed OK or the message box is interrupted by time-out or signal action.

The input numeric value and interrupt reason are transferred back to the program.

New message box on trap level takes the focus from the message box on the basic level.

Continues on next page

Predefined data

The following constants of the data type `icondata` are predefined in the system:

Value	Constant	Icon
0	<code>iconNone</code>	No icon
1	<code>iconInfo</code>	Information icon
2	<code>iconWarning</code>	Warning icon
3	<code>iconError</code>	Error icon
4	<code>iconQuestion</code>	Question icon

Error handling

The following recoverable errors are generated and can be handled in an error handler. The system variable `ERRNO` will be set to:

Name	Cause of error
<code>ERR_NO_ALIASIO_DEF</code>	The signal variable is a variable declared in RAPID. It has not been connected to an I/O signal defined in the I/O configuration with instruction <code>AliasIO</code> .
<code>ERR_TP_NO_CLIENT</code>	There is no client, for example, a FlexPendant, to take care of the instruction.
<code>ERR_UI_ICON</code>	The argument <code>Icon</code> of type <code>icondata</code> has a not allowed value.
<code>ERR_UI_INITVALUE</code>	The initial value (parameter <code>\InitValue</code>) is not specified within the range of the minimum and maximum value (parameters <code>\MinValue</code> and <code>\MaxValue</code>).
<code>ERR_UI_MAXMIN</code>	The minimum value (parameter <code>\MinValue</code>) is greater than the maximum value (parameter <code>\MaxValue</code>).

If parameter `\BreakFlag` is not used, these situations can then be dealt with by the error handler:

- If there is a time-out (parameter `\MaxTime`) before an input from the operator then the system variable `ERRNO` is set to `ERR_TP_MAXTIME` and the execution continues in the error handler.
- If digital input is set (parameter `\DIBreak`) before an input from the operator then the system variable `ERRNO` is set to `ERR_TP_DIBREAK` and the execution continues in the error handler.
- If a digital output is set (parameter `\DOBBreak`) before an input from the operator then the system variable `ERRNO` is set to `ERR_TP_DOBREAK` and the execution continues in the error handler.
- If a persistent boolean is set (parameter `\PersBoolBreak`) before an input from the operator then the system variable `ERRNO` is set to `ERR_TP_PERSBOOLBREAK` and the execution continues in the error handler.

More examples

The following example illustrates the function `UINumTune`.

Example 1

```
VAR errnum err_var;
```

Continues on next page

2 Functions

2.218 UINumTune - User Number Tune

RobotWare Base

Continued

```
VAR num tune_answer;
VAR num distance;
...
tune_answer := UINumTune (\Header:=" BWD move on path"
    \Message:="Enter the path overlap ?" \Icon:=iconInfo, 5, 1
    \MinValue:=0 \MaxValue:=10 \MaxTime:=60 \DIBreak:=di5
    \BreakFlag:=err_var);
TEST err_var
CASE ERR_TP_MAXTIME:
CASE ERR_TP_DIBREAK:
    ! No operator answer
    distance := 5;
CASE 0:
    ! Operator answer
    distance := tune_answer;
DEFAULT:
    ! No such case defined
ENDTEST
```

The tune message box is displayed and the operator can tune the numeric value and press OK. The message box can also be interrupted with time-out or break by digital input signal. In the program it's possible to find out the reason and take the appropriate action.

Limitations

Avoid using too small a value for the time-out parameter `\MaxTime` when `UINumTune` is frequently executed, for example in a loop. It can result in unpredictable behavior from the system performance, like slow response of the FlexPendant.

Syntax

```
UINumTune '('
    ['\ Header :=' <expression (IN) of string>]
    [Message :=' <expression (IN) of string > ]
    | ['\ MsgArray :=' <array {*} (IN) of string>]
    ['\ Wrap]
    ['\ Icon :=' <expression (IN) of icondata>]
    [InitValue :=' <expression (IN) of num>]
    [Increment :=' <expression (IN) of num>]
    ['\ MinValue :=' <expression (IN) of num>]
    ['\ MaxValue :=' <expression (IN) of num>]
    ['\ MaxTime :=' <expression (IN) of num>]
    ['\ DIBreak :=' <variable (VAR) of signaldi>]
    ['\ DIPassive]
    ['\ DOBreak :=' <variable (VAR) of signaldo>]
    ['\ DOPassive]
    ['\ PersBoolBreak :=' <persistent (PERS) of bool>]
    ['\ PersBoolPassive]
    ['\ BreakFlag :=' <var or pers (INOUT) of errnum>]
    ['\ UIActiveSignal :=' <variable (VAR) of signaldo>] ')'

```

A function with return value of the data type `num`.

Continues on next page

Related information

For information about	See
Icon display data	icondata - Icon display data on page 1671
User interaction message box type basic	UIMsgBox - User Message Dialog Box type basic on page 992
User interaction message box type advanced	UIMessageBox - User Message Box type advanced on page 1567
User interaction number entry	UINumEntry - User Number Entry on page 1576
User interaction alpha entry	UIAlphaEntry - User Alpha Entry on page 1536
User interaction list view	UIListView - User List View on page 1558
System connected to FlexPendant etc.	UIClientExist - Exist User Client on page 1543
Clean up the operator window	TPErase - Erases text printed on the Flex-Pendant on page 865

2 Functions

2.219 ValidIO - Valid I/O signal to access

RobotWare Base

2.219 ValidIO - Valid I/O signal to access

Usage

`ValidIO` is used to check if the specified I/O signal can be accessed without any error at present.

Basic examples

The following example illustrates the function `ValidIO`.

Example 1

```
IF ValidIO(mydosignal) SetDO mydosignal, 1;
```

Set the digital output signal `mydosignal` to 1 if its I/O device is up and running.

Return value

Data type: `bool`

Returns `TRUE` if the I/O signal is valid and the I/O device for the signal is up and running.

Returns `FALSE` if the I/O device is not up and running, or if no `AliasIO` instruction has been executed to connect a signal variable declared in the RAPID program to a signal defined in I/O configuration.

Arguments

`ValidIO (Signal)`

Signal

Data type: `signalxx`

The I/O signal name. Must be of data type `signaldo`, `signaldi`, `signalgo`, `signalgi`, `signalao` or `signalai`.

Program execution

Execution behaviour:

- Check if valid I/O signal
- Check if the I/O device for the signal is up and running.

No error messages are generated.

Syntax

```
ValidIO '('  
  [Signal ':=' ] <variable (VAR) of anytype> ')'
```

A function with a return value of the data type `bool`.

Related information

For information about	See
Input/Output instructions	<i>Technical reference manual - RAPID Overview</i>
Input/Output functionality in general	<i>Technical reference manual - RAPID Overview</i>

Continues on next page

For information about	See
Configuration of I/O	<i>Technical reference manual - System parameters</i>
Define I/O signal with alias name	AliasIO - Define I/O signal with alias name on page 36
Read attribute of a system parameter	ReadCfgData - Reads attribute of a system parameter on page 586

2 Functions

2.220 ValToStr - Converts a value to a string

RobotWare Base

2.220 ValToStr - Converts a value to a string

Usage

`ValToStr` (*Value To String*) is used to convert a value of any data type to a string.

Basic examples

The following examples illustrate the function `ValToStr`.

Example 1

```
VAR string str;  
VAR pos p := [100,200,300];  
str := ValToStr(p);
```

The variable `str` is given the value "[100,200,300]".

Example 2

```
str := ValToStr(TRUE);
```

The variable `str` is given the value `TRUE`.

Example 3

```
str := ValToStr(1.234567890123456789);
```

The variable `str` is given the value "1.23456789012346".

Example 4

```
VAR num numtype:=1.234567890123456789;
```

```
str := ValToStr(numtype);
```

The variable `str` is given the value "1.23457".

Example 5

```
VAR dnum dnumtype:=1.234567890123456789;
```

```
str := ValToStr(dnumtype);
```

The variable `str` is given the value "1.23456789012346".

Return value

Data type: `string`

The value is converted to a string with standard `RAPID` format. This means, in principle, 6 significant digits. Literal value interpreted as a `dnum` (see example 3) and `dnum` variables (see example 5) though have 15 significant digits.

A runtime error is generated if the resulting string is too long.

Arguments

```
ValToStr ( Val )
```

`Val`

Value

Data type: `anytype`

A value of any data type. All types of value data with structure atomic, record, record component, array, or array element can be used.

Continues on next page

Syntax

```
ValToStr '('  
  [ Val ':=' ] <expression (IN) of anytype> ')'
```

A function with a return value of the data type `string`.

Related information

For information about	See
String functions	<i>Technical reference manual - RAPID Overview</i>
Definition of string	string - Strings on page 1761
String values	<i>Technical reference manual - RAPID Overview</i>

2 Functions

2.221 VectMagn - Magnitude of a pos vector *RobotWare Base*

2.221 VectMagn - Magnitude of a pos vector

Usage

`VectMagn` (*Vector Magnitude*) is used to calculate the magnitude of a `pos` vector.

Basic examples

The following example illustrates the function `VectMagn`.

Example 1

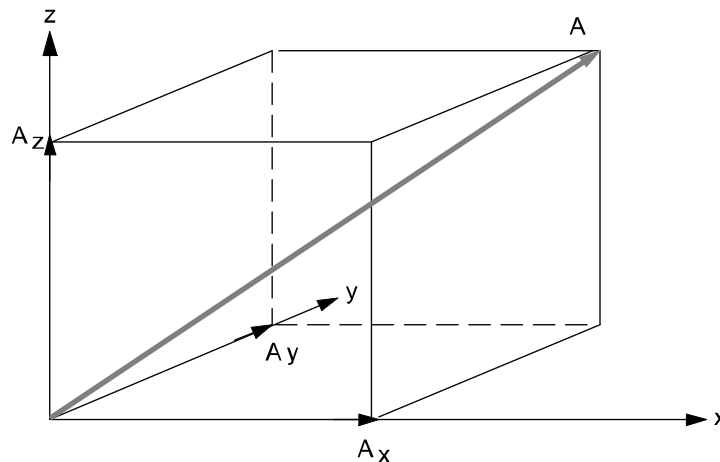

xx0500002446

A vector **A** can be written as the sum of its components in the three orthogonal directions:

$$\mathbf{A} = A_x \mathbf{x} + A_y \mathbf{y} + A_z \mathbf{z}$$

The magnitude of **A** is:

$$|\mathbf{A}| = \sqrt{A_x^2 + A_y^2 + A_z^2}$$

The vector is described by the data type `pos` and the magnitude by the data type `num`:

```
VAR num magnitude;  
VAR pos vector;  
...  
vector := [1,1,1];  
magnitude := VectMagn(vector);
```

Return value

Data type: `num`

The magnitude of the vector (data type `pos`).

Arguments

`VectMagn` (`Vector`)

Continues on next page

Vector

Data type: pos

The vector described by the data type pos.

Syntax

```
VectMagn '('  
  [Vector ':='] <expression (IN) of pos> ')'
```

A function with a return value of the data type num.

Related information

For information about	See
Mathematical instructions and functions	<i>Technical reference manual - RAPID Overview</i>

2 Functions

2.222 XOR - Evaluates a logical value

RobotWare Base

2.222 XOR - Evaluates a logical value

Usage

XOR (*Exclusive Or*) is a conditional expression used to evaluate a logical value (true/false).

Basic examples

The following examples illustrate the function XOR.

Example 1

```
VAR bool a;  
VAR bool b;  
VAR bool c;  
c := a XOR b;
```

The return value `c` is `TRUE` if one, and only one, of `a` or `b` are `TRUE`. Otherwise the return value is `FALSE`.

Example 2

```
VAR num a;  
VAR num b;  
VAR bool c;  
...  
c := a>5 XOR b=3;
```

The return value of `c` is `TRUE` if one, and only one, of the conditions are `TRUE`. Either `a` is larger than 5, or `b` equals 3. Otherwise the return value is `FALSE`.

Return value

Data type: `bool`

The return value is `TRUE` if one, and only one, of the conditional expressions are correct. Otherwise the return value is `FALSE`.

Syntax

```
<expression of bool> XOR <expression of bool>
```

A function with a return value of data type `bool`.

Related information

For information about	See
AND	AND - Evaluates a logical value on page 1151
OR	OR - Evaluates a logical value on page 1384
NOT	NOT - Inverts a logical value on page 1375
Expressions	Technical reference manual - RAPID Overview

3 Data types

3.1 aiotrigg - Analog I/O trigger condition

Usage

`aiotrigg` (*Analog I/O Trigger*) is used to define the condition to generate an interrupt for an analog input or output signal.

Description

Data of the type `aiotrigg` defines the way a low and a high threshold will be used to determine whether the logical value of an analog signal satisfies a condition to generate an interrupt.

Basic examples

The following example illustrates the data type `aiotrigg`:

Example 1

```
VAR intnum siglint;
PROC main()
  CONNECT siglint WITH iroutine1;
  ISignalAI \Single, ail, AIO_BETWEEN, 1.5, 0.5, 0, siglint;
```

Orders an interrupt which is to occur the first time the logical value of the analog input signal `ail` is between 0.5 and 1.5. A call is then made to the `iroutine1` trap routine.

Predefined data

The following symbolic constants of the data type `aiotrigg` are predefined and can be used when specifying a condition for the instructions `ISignalAI` and `ISignalAO`.

Value	Symbolic constant	Comment
1	AIO_ABOVE_HIGH	Signal will generate interrupts if above specified high value
2	AIO_BELOW_HIGH	Signal will generate interrupts if below specified high value
3	AIO_ABOVE_LOW	Signal will generate interrupts if above specified low value
4	AIO_BELOW_LOW	Signal will generate interrupts if below specified low value
5	AIO_BETWEEN	Signal will generate interrupts if between specified low and high values
6	AIO_OUTSIDE	Signal will generate interrupts if below specified low value or above specified high value
7	AIO_ALWAYS	Signal will always generate interrupts

Characteristics

`aiotrigg` is an alias data type for `num` and consequently inherits its characteristics.

Continues on next page

3 Data types

3.1 aiotrigger - Analog I/O trigger condition

RobotWare Base

Continued

Related information

For information about	See
Interrupt from analog input signal	ISignalAI - Interrupts from analog input signal on page 305
Interrupt from analog output signal	ISignalAO - Interrupts from analog output signal on page 315
Data types in general, alias data types	<i>Technical reference manual - RAPID Overview, section Basic characteristics - Data types</i>

3.2 ALIAS - Assigning an alias data type

Usage

ALIAS is used to define a data type as being equal to another data type. Alias types provide a means to classify objects. The system may use the alias classification to look up and present type related objects. An alias type is introduced by an alias definition.

The built-in alias types are `errnum` and `intnum`, both aliases for `num`.

`errnum` type

The `errnum` type is an alias for `num` and is used for the representation of error numbers.

`intnum` type

The `intnum` type is an alias for `num` and is used for the representation of interrupt numbers.

Basic examples

The following example illustrates the ALIAS definition.

Example 1

```
ALIAS num level;
CONST level low := 2.5;
CONST level high := 4.0;
```

An alias type `level` is defined (alias for `num`).

Limitations

To be recognized by RAPID, any alias definitions must be declared at the very top of the program or system module before all other data declarations. The only data type that is allowed to be declared before alias is `RECORD`.

One alias type cannot be defined upon another alias type.

Syntax

```
ALIAS <type name> <identifier> ';'
Alias definition.
```

Related information

For information about	See
<code>errnum</code> - Error number	errnum - Error number on page 1653
<code>intnum</code> - Interrupt identity	intnum - Interrupt identity on page 1675
Lexical elements	<i>Technical reference manual - RAPID kernel</i>

3 Data types

3.3 bool - Logical values

RobotWare Base

3.3 bool - Logical values

Usage

`bool` is used for logical values (true/false).

Description

The value of data of the type `bool` can be either `TRUE` or `FALSE`.

Basic examples

The following examples illustrate the data type `bool` :

Example 1

```
flag1 := TRUE;
```

`flag` is assigned the value `TRUE`.

Example 2

```
VAR bool highvalue;  
VAR num reg1;  
...  
highvalue := reg1 > 100;
```

`highvalue` is assigned the value `TRUE` if `reg1` is greater than 100; otherwise, `FALSE` is assigned.

Example 3

```
IF highvalue Set dol;
```

The `dol` signal is set if `highvalue` is `TRUE`.

Example 4

```
highvalue := reg1 > 100;  
mediumvalue := reg1 > 20 AND NOT highvalue;
```

`mediumvalue` is assigned the value `TRUE` if `reg1` is between 20 and 100.

Related information

For information about	See
Logical expressions	<i>Technical reference manual - RAPID Overview, section Basic characteristics - Expressions</i>
Operations using logical values	<i>Technical reference manual - RAPID Overview, section Basic characteristics - Expressions</i>

3.4 btnres - Push button result data

Usage

`btnres` (*button result*) is used for representing the user selection of the push button display on the User Device such as the FlexPendant.

Description

A `btnres` constant is intended to be used when checking the result value from the instruction `UIMsgBox` and the return value from the functions `UIMessageBox` and `UIListView`.

Basic examples

The following example illustrates the data type `btnres`:

Example 1

```
VAR btnres answer;

UIMsgBox "More ?" \Buttons:=btnYesNo \Result:= answer;
IF answer= resYes THEN
  ...
ELSEIF answer =ResNo THEN
  ...
ENDIF
```

The standard button enumeration `btnYesNo` will give one Yes and one No push button on the user interface. The user selection will be stored in the variable `answer`.

Predefined data

The following constants of the data type `btnres` are predefined in the system.

Value	Constants	Button answer
0	<code>resUnkwn</code>	Unknown result
1	<code>resOK</code>	OK
2	<code>resAbort</code>	Abort
3	<code>resRetry</code>	Retry
4	<code>resIgnore</code>	Ignore
5	<code>resCancel</code>	Cancel
6	<code>resYes</code>	Yes
7	<code>resNo</code>	No

It is possible to work with user defined push buttons that answer with the functions `UIMessageBox` and `UIListView`.

Characteristics

`btnres` is an alias data type for `num` and consequently inherits its characteristics.

Continues on next page

3 Data types

3.4 btnres - Push button result data

RobotWare Base

Continued

Related information

For information about	See
User Interaction Message Box	UIMsgBox - User Message Dialog Box type basic on page 992
User Interaction Message Box	UIMessageBox - User Message Box type advanced on page 1567
User Interaction List View	UICollection - User List View on page 1558
Alias data type button data	buttondata - Push button data on page 1604

3.5 busstate - State of I/O network

Usage

`busstate` is used to mirror which state an I/O network is currently in.

Description

A `busstate` constant is intended to be used when checking the return value from the instruction `IOBusState`.

Basic examples

The following example illustrates the data type `busstate`:

Example 1

```

VAR busstate bstate;

IOBusState "IBS", bstate \Phys;
TEST bstate
CASE IOBUS_PHYS_STATE_RUNNING:
    ! Possible to access some signal on the IBS bus
DEFAULT:
    ! Actions for not up and running IBS bus
ENDTEST

```

Predefined data

The predefined symbolic constants of the data type `busstate` can be viewed in instruction `IOBusState`.

Characteristics

`busstate` is an alias data type for `num` and consequently inherits its characteristics.

Related information

For information about	See
Get current state of I/O network	IOBusState - Get current state of I/O network on page 286
Input/Output instructions	<i>Technical reference manual - RAPID Overview, section RAPID Summary - Input and Output Signals</i>
Input/Output functionality in general	<i>Technical reference manual - RAPID Overview, section Motion and I/O Principles - I/O Principles</i>
Configuration of I/O	<i>Technical reference manual - System parameters</i>

3 Data types

3.6 buttodata - Push button data

RobotWare Base

3.6 buttodata - Push button data

Usage

`buttodata` is used for representing a standard push button combination for display on the User Device such as the FlexPendant.

Description

A `buttodata` constant is used for representing response push buttons in instruction `UIMsgBox` and functions `UIMessageBox` and `UIListView`.

Basic examples

The following example illustrates the data type `buttodata`:

Example 1

```
VAR btnres answer;  
UIMsgBox "More ?" \Buttons:=btnYesNo \Result:= answer;  
IF answer= resYes THEN  
...  
ELSE  
...  
ENDIF
```

The standard button enumeration `btnYesNo` will give one Yes and one No push button.

Predefined data

The following constants of the data type `buttodata` are predefined in the system.

Value	Constants	Button displayed
-1	<code>btnNone</code>	No button
0	<code>btnOK</code>	OK
1	<code>btnAbtrRtryIgn</code>	Abort, Retry and Ignore
2	<code>btnOKCancel</code>	OK and Cancel
3	<code>btnRetryCancel</code>	Retry and Cancel
4	<code>btnYesNo</code>	Yes and No
5	<code>btnYesNoCancel</code>	Yes, No and Cancel

It is possible to display user defined push buttons with the functions `UIMessageBox` and `UIListView`.

Characteristics

`buttodata` is an alias data type for `num` and consequently inherits its characteristics.

Continues on next page

Related information

For information about	See
User Interaction Message Box	UIMsgBox - User Message Dialog Box type basic on page 992
User Interaction Message Box	UIMessageBox - User Message Box type advanced on page 1567
User Interaction List View	UIListView - User List View on page 1558
Alias data type button result	btnres - Push button result data on page 1601
Data types in general, alias data types	<i>Technical reference manual - RAPID Overview, section Basic Characteristics - Data Types</i>

3 Data types

3.7 byte - Integer values 0-255

RobotWare Base

3.7 byte - Integer values 0-255

Usage

`byte` is used for integer values (0 - 255) according to the range of a byte.

This data type is used in conjunction with instructions and functions that handle the bit manipulations and convert features.

Description

Data of the type `byte` represents an integer byte value.

Basic examples

The following examples illustrate the data type `byte`:

Example 1

```
VAR byte data1 := 130;
```

Definition of a variable `data1` with a decimal value 130.

Example 2

```
CONST num parity_bit := 8;  
VAR byte data1 := 130;  
BitClear data1, parity_bit;
```

Bit number 8 (`parity_bit`) in the variable `data1` will be set to 0, e.g. the content of the variable `data1` will be changed from 130 to 2 (integer representation).

Error handling

If an argument of the type `byte` has a value that is not in the range between 0 and 255, an error is returned on program execution.

Characteristics

`byte` is an alias data type for `num` and consequently inherits its characteristics.

Related information

For information about	See
Alias data types	<i>Technical reference manual - RAPID Overview</i>
Bit functions	<i>Technical reference manual - RAPID Overview</i>
<i>Advanced RAPID</i>	<i>Product specification - Controller software IRC5</i>

3.8 cameradev - camera device

Usage

`cameradev` (*camera device*) is used to define the different camera devices which can be controlled and accessed from the RAPID program. The data type `cameradev` is used for instructions and functions communicating with a camera. The names of the camera devices are defined in the system parameters and, consequently, must not be defined in the program.

Description

Data of the type `cameradev` only contains a reference to the camera device.

Basic examples

The following example illustrates the data type `cameradev`.

Example 1

```
CamLoadJob mycamera, "myjob.job";
```

Predefined data

All cameras defined in the system parameters are predefined in every program task.

Limitations

Data of the type `cameradev` must not be defined in the program. However, if it is then an error message will be displayed as soon as an instruction or function that refers to this `cameradev` is executed. The data type can, on the other hand, be used as a parameter when declaring a routine.

Characteristics

`cameradev` is a non-value data type. This means that data of this type does not permit value-oriented operations.

Related information

For information about	See
Integrated Vision	<i>Application manual - Integrated Vision</i>

3 Data types

3.9 camerastatus - Camera communication status

Integrated Vision

3.9 camerastatus - Camera communication status

Usage

`camerastatus` is used for representing the status of the communication with the camera.

Description

Camera status is fetched with the function `CamGetMode` and can be used for program flow control or debugging purposes.

Basic examples

The following example illustrates the data type `camerastatus`:

Example 1

```
VAR camerastatus curr_camerastatus;
...
curr_camerastatus:=CamGetMode(mycamera);
IF curr_camerastatus = CAMERA_DISCON THEN
    TPWrite "Current mode of camera " + CamGetName(mycamera) + " is
        CAMERA_DISCON";
ELSEIF curr_camerastatus = CAMERA_STANDBY THEN
    TPWrite "Current mode of camera "+CamGetName(mycamera) + " is
        CAMERA_STANDBY";
ELSEIF curr_camerastatus = CAMERA_RUNNING THEN
    TPWrite "Current mode of camera " + CamGetName(mycamera) + " is
        CAMERA_RUNNING";
ENDIF
```

Get current mode of the camera, and write the status to the FlexPendant.

Predefined data

Following constants of type `camerastatus` are predefined:

RAPID constant	Value	
CAMERA_DISCON	1	The camera is disconnected.
CAMERA_STANDBY	2	The camera is in standby mode.
CAMERA_RUNNING	3	The camera is running.

Characteristics

`camerastatus` is an alias data type for `num` and consequently inherits its characteristics.

Related information

For information about	See
Integrated Vision	<i>Application manual - Integrated Vision</i>
Get camera mode	CamGetMode - Get current mode of camera on page 1213

Continues on next page

For information about	See
Data types in general, alias data types	<i>Technical reference manual - RAPID Overview, section Basic Characteristics - Data Types</i>

3 Data types

3.10 cameratarget - camera data

Integrated Vision

3.10 cameratarget - camera data

Usage

`cameratarget` is used to exchange vision data from the camera image to the RAPID program.

Description

Data of the type `cameratarget` is a user defined collection of data that can be set up to exchange vision data from the camera image to the RAPID program.

The data has a range of components that can be set up according to the specific needs in the current vision application. The `cframe` component is meant for transmitting information about the location of an object whereas the numerical values and the strings are meant to hold inspection data.

Basic examples

The following example illustrates the data type `cameratarget`.

Example 1

```
VAR cameratarget target1;
...
wobjmycamera.oframe := target1.cframe;
MoveL pickpart, v100, fine, mygripper \WObj:= wobjmycamera;
```

The `cframe` coordinate transformation is assigned to the object frame of the work object. The `robtarget pickpart` has previously been tuned to a correct picking position within the object frame of the work object.

Components

The data type has the following components:

`name`

Data type: `string`

The name identifier of the `cameratarget`.

`cframe`

current frame

Data type: `pose`

For storing position data which is normally used for guiding the robot by modifying the work object.

`val1`

value 1

Data type: `num`

For storing numerical outputs such as measurements.

...

`val5`

value 5

Continues on next page

	Data type: num
	For storing numerical outputs such as measurements.
string1	Data type: string
	For storing numerical vision output such as inspection or identification output.
string2	Data type: string
	For storing numerical vision output such as inspection or identification output.
type	Data type: num
	A numerical identifier of the camera target. Similar purpose as the <code>name</code> component.
cameraname	Data type: string
	The name of the camera.
sceneid	scene identification
	Data type: num
	The unique identifier of the image used to generate the <code>cameratarget</code> .

Structure

```

< dataobject of cameratarget >
  < name of string >
  < cframe of pose >
    < trans of pos >
    < rot of orient >
  < val1 of num >
  < val2 of num >
  < val3 of num >
  < val4 of num >
  < val5 of num >
  < string1 of string >
  < string2 of string >
  < type of num >
  < cameraname of string >
  < sceneid of num >

```

Related information

For information about	See
Integrated Vision	<i>Application manual - Integrated Vision</i>

3 Data types

3.11 capaptrreferencedata - Variable setup data for At-Point-Tracker Continuous Application Platform (CAP)

3.11 capaptrreferencedata - Variable setup data for At-Point-Tracker

Usage

capaptrreferencedata is used to setup the needed information for the At-Point-Tracker correction process setup by the CapAPTrSetupAO, CapAPTrSetupAI, and CapAPTrSetupPERS instructions.

Components

reference_y

Data type: num

Defines the reference for the Y position.

reference_z

Data type: num

Defines the reference for the Z position.

threshold_y

Data type: num

The difference between the input signal and the reference_y value must be greater than the threshold_y value for the regulator to react on the change.

threshold_z

Data type: num

The difference between the input signal and the reference_z value must be greater than the threshold_z value for the regulator to react on the change.

gain_y

Data type: num

The difference between the reference_y value and the input signal value is scaled with the gain_y value.

gain_z

Data type: num

The difference between the reference_z value and the input signal value is scaled with the gain_z value.

Structure

```
< data object of capaptrreferencedata >
  < reference_y of num >
  < reference_z of num >
  < threshold_y of num >
  < threshold_z of num >
  < gain_y of num >
  < gain_z of num >
```

Continues on next page

3.11 capptrreferencedata - Variable setup data for At-Point-Tracker
Continuous Application Platform (CAP)

Continued

Related information

For information about	See
Instruction CapAPTrSetupAI	CapAPTrSetupAI - Setup an At-Point-Tracker controlled by analog input signals on page 83
Instruction CapAPTrSetupAO	CapAPTrSetupAO - Setup an At-Point-Tracker controlled by analog output signals on page 86
Instruction CapAPTrSetupPERS	CapAPTrSetupPERS - Setup an At-Point-Tracker controlled by persistent variables on page 89
Continuous Application Platform	Application manual - Continuous Application Platform
Sensor Interface	Application manual - Controller software IRC5

3 Data types

3.12 capdata - CAP data

Continuous Application Platform (CAP)

3.12 capdata - CAP data

Usage

capdata contains all data necessary for defining the behavior of the CAP process.

Components

start_fly

Flying start

Data type: bool

Defines whether or not flying start is used:

Value	Consequence
TRUE	flying start is used
FALSE	flying start is NOT used

Flying start means that the robot movement is started before the process is started. The process is then started on the run (see [flypointdata - Data for flying start/end on page 1667](#)).

end_fly

Flying end

Data type: bool

Defines whether or not flying end is used:

Value	Consequence
TRUE	flying end is used
FALSE	flying end is NOT used

Flying end means that the CAP process can be terminated before the robot reaches the end point, thus allowing the robot to leave the process path on the run that is, using a zone point (see [flypointdata - Data for flying start/end on page 1667](#)).

first_instr

First instruction

Data type: bool

Defines whether or not a CapL/CapC instruction is the first instruction in a sequence of CapL/CapC instructions:

Value	Consequence
TRUE	this is the first instruction in a sequence of CapL/CapC instructions
FALSE	this is not the first instruction in a sequence of CapL/CapC instructions

last_instr

Last instruction

Data type: bool

Continues on next page

Defines whether or not a CapL/CapC instruction is the last instruction in a sequence of CapL/CapC instructions:

Value	Consequence
TRUE	this is the last instruction in a sequence of CapL/CapC instructions
FALSE	this is not the last instruction in a sequence of CapL/CapC instructions

restart_dist

Restart distance, unit: mm

Data type: num

Defines the distance the robot has to back along the path, when it is restarted after having encountered a stop when a CAP process was active.

In MultiMove systems all synchronized robots must use the same restart distance.

speed_data

Speed data for CAP

Data type: capspeeddata

Defines all CAP data concerning speed (see [capspeeddata - Speed data for CAP on page 1622](#)).

start_fly_point

Data type: flypointdata

These data are only taken into account when `start_fly` is TRUE.

Defines flying start information for the CAP process (see [flypointdata - Data for flying start/end on page 1667](#).)

end_fly_point

Data type: flypointdata

These data are only taken into account when `end_fly` is TRUE.

Defines flying end information for the CAP process (see [flypointdata - Data for flying start/end on page 1667](#).)

sup_timeouts

Data type: supervtimeouts

Defines the timeouts used for all handshake supervision phases (see [supervtimeouts - Handshake supervision time outs on page 1764](#) and section *Supervision in Application manual - Continuous Application Platform*).

proc_times

Data type: processtimes

Defines the timeouts used for the status supervision phases PRE, POST1, and POST2 (see [processtimes - process times on page 1718](#) and section *Supervision and process phases in Application manual - Continuous Application Platform*).

block_at_restart

Data type: restartblkdata

Continues on next page

3 Data types

3.12 capdata - CAP data

Continuous Application Platform (CAP)

Continued

Defines the behavior of the CAP process during a restart (see [restartblkdata - blockdata for restart on page 1723](#)).

Structure

```
< data object of capdata >
  < start_fly of bool >
  < end_fly of bool >
  < first_instr of bool >
  < last_instr of bool >
  < restart_dist of num >
  < speed_data of capspeeddata >
    < fly_start of num >
    < start of num >
    < startspeed_time of num >
    < startmove_delay of num >
    < main of num >
    < fly_end of num >
  < start_fly_point of flypointdata >
    < from_start of bool >
    < time_before of num >
    < distance of num >
  < end_fly_point of flypointdata >
    < from_start of bool >
    < time_before of num >
    < distance of num >
  < sup_timeouts of supervtimeouts >
    < pre_cond of num >
    < start_cond of num >
    < end_main_cond of num >
    < end_post1_cond of num >
    < end_post2_cond of num >
  < proc_times of processtimes >
    < pre of num >
    < post1 of num >
    < post2 of num >
  < block_at_restart of restartblkdata >
    < weave_start of bool >
    < motion_delay of bool >
    < pre_phase of bool >
    < startspeed_phase of bool >
    < post1_phase of bool >
    < post2_phase of bool >
```

Related information

	Described in:
<i>Continuous Application Platform</i>	<i>Application manual - Continuous Application Platform</i>
capspeeddata data type	capspeeddata - Speed data for CAP on page 1622

Continues on next page

3 Data types

3.12 capdata - CAP data
Continuous Application Platform (CAP)
Continued

	Described in:
flypointdata data type	flypointdata - Data for flying start/end on page 1667
supervtimeouts data type	supervtimeouts - Handshake supervision time outs on page 1764
processtimes data type	processtimes - process times on page 1718
block_at_restart data type	restartblkdata - blockdata for restart on page 1723
CapL instruction	CapL - Linear CAP movement instruction on page 107
CapC instruction	CapC - Circular CAP movement instruction on page 92

3 Data types

3.13 capltrackdata - CAP Look-Ahead-Tracker track data *Continuous Application Platform (CAP)*

3.13 capltrackdata - CAP Look-Ahead-Tracker track data

Usage

capltrackdata contains data, with which the user can influence how the CapL/CapC instructions incorporate the path correction data generated by a Look-Ahead-Tracker (for example, Laser Tracker). capltrackdata is part of the captrackdata.

Basic examples

```
PERS captrackdata captrack := ["laser1:",50,[1,10,1,0,0,0,0,0]]
CapL p1, v200, cd, wsd, cwd, z20, tWeldGun \Track:=captrack;
```

Components

joint_no

Data type: num

Defines the joint type (expressed as a number) the sensor equipment shall use during tracking.

filter

Data type: num

Defines the time constant of a low pass filter applied to path corrections. The component may be set to values between 1 and 10 where 1 gives the fastest response (no filtering) to path errors detected by the sensor.

calibframe_no

Data type: num

Defines which calibration frame of the three frames defined in CapLATrSetup, that shall be used.

Value	Calibration frame	Description
1	calibframe	Mandatory in CapLATrSetup
2	calibframe2	Optional in CapLATrSetup
3	calibframe3	Optional in CapLATrSetup)

seamoffs_y, seamoffs_z

Data type: num

The seam offset components are used to add constant offsets to the sensor generated path (in mm). If for example the sensor considers the upper edge of a

Continues on next page

lap joint to be the correct seam position, as indicated in the figure below, the seam offsets may be used to correct the path.

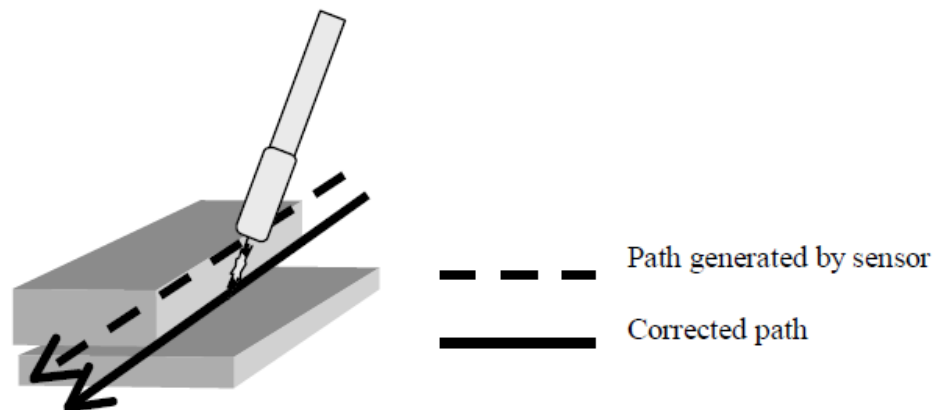

xx120000199

The corrections are defined in the path coordinate system, which is right handed.

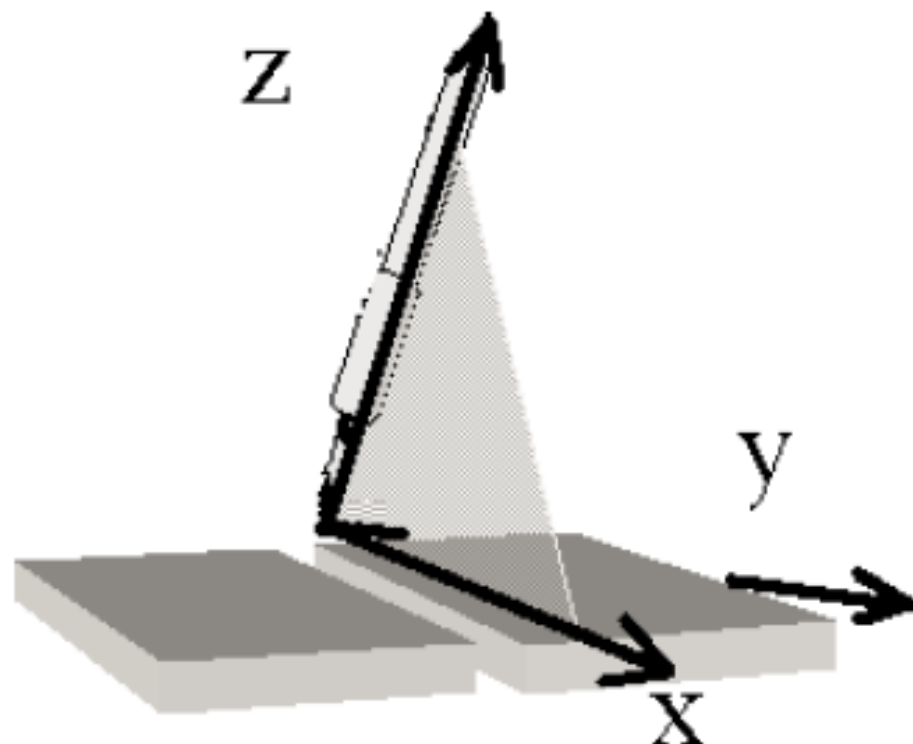

xx120000200

- The x-direction is parallel to the path tangent.
- The z-direction is the tool z-vector.
- The x-direction is perpendicular to a plane through the x and z-directions.

seamadapt_y, seamadapt_z

Data type: num

Continues on next page

3 Data types

3.13 caplatrackdata - CAP Look-Ahead-Tracker track data

Continuous Application Platform (CAP)

Continued

The seam adapt components are similar to the seam offset components. The magnitudes of the offsets are however not given as fixed values. The offsets are calculated as the measured seam gap multiplied by the seam adapt values.

The components are used to adapt the tool offset with respect to the seam to optimize the process for different gap sizes.

track_mode

Data type: num

With the `track_mode` component it is possible to selectively influence the tracking behavior of a laser tracker.

Value	Track Mode
0	Normal tracking. y- and z-corrections are both taken into account
1	Tracking as if y-corrections sent by the Laser Tracker were zero. z-corrections are taken into account. ⁱ
2	Tracking as if z-corrections sent by the Laser Tracker were zero. y-corrections are taken into account. ⁱ
3	Tracking as if y- and z-corrections sent by the Laser Tracker were zero. ⁱ
4	y-correction switched off totally, that is, the correction of the y component is set to zero before it is sent to the robot. z-correction is taken into account. ⁱⁱ
5	z-correction switched off totally, that is, the correction of the z component is set to zero before it is sent to the robot. y-correction is taken into account. ⁱⁱ
6	y- and z-corrections are switched off totally, that is, the correction of the y and the z component is set to zero before it is sent to the robot. ⁱⁱ
7	y-correction is faded out, that is, the TCP returns ramped to the programmed y component of the path. z-correction is active.
8	z-correction is faded out, that is, the TCP returns ramped to the programmed z component of the path. y-correction is active.
9	y- and z-corrections are faded out, that is, the TCP returns ramped to the programmed path.
10	y-correction is faded in, that is, the TCP returns ramped to the programmed y component of the path. z-correction is active.
11	z-correction is faded in, that is, the TCP returns ramped to the programmed z component of the path. y-correction is active.
12	y- and z-corrections are faded in, that is, the TCP returns ramped to the programmed path.
13	Tracking as if y-corrections sent by the Laser Tracker were zero. z-corrections are taken into account. The difference to <code>track_mode 1</code> is, that the mode starts at the robot TCP position and not at the sensor TCP position. ⁱ
14	Tracking as if z-corrections sent by the Laser Tracker were zero. y-corrections are taken into account. The difference to <code>track_mode 2</code> is that the mode starts at the robot TCP position and not at the sensor TCP position. ⁱ

Continues on next page

3.13 capltrackdata - CAP Look-Ahead-Tracker track data

*Continuous Application Platform (CAP)**Continued*

Value	Track Mode
15	Tracking as if y- and z-corrections sent by the Laser Tracker were zero. The difference to <code>track_mode 3</code> is that the mode starts at the robot TCP position and not at the sensor TCP position. ⁱ

- ⁱ For `track_mode 1, 2, or 3`, the accumulated correction from the previous `CapL/CapC` instruction will be preserved for y or/and z and passed on to the next `CapL/CapC` instruction. This is the case during the hole lifetime of the CAP process. A new CAP process will be unaffected
- ⁱⁱ For `track_mode 4, 5, or 6`, the sensor readings are accumulated even though y- and/or z-correction is set to zero before sending to the robot. That means, a 'dip' might occur in the beginning and in the end of the `CapL/CapC` instruction.

Syntax

```

< data object of capltrackdata >
  < joint_no of num >
  < filter of num >
  < calibframe_no of num >
  < seamoffs_y of num >
  < seamoffs_z of num >
  < seamadapt_y of num >
  < seamadapt_z of num >
  < track_mode of num >

```

Related information

	Described in:
<code>captrackdata</code> data type	captrackdata - CAP track data on page 1625
<i>Continuous Application Platform</i>	<i>Application manual - Continuous Application Platform</i>

3 Data types

3.14 capspeeddata - Speed data for CAP Continuous Application Platform (CAP)

3.14 capspeeddata - Speed data for CAP

Usage

`capspeeddata` is used to define all data concerning velocity for a CAP process - it is part of `capdata` and defines all velocity data and process times needed for a CAP process:

- velocity and how long this velocity shall be used at the start of the CAP process,
- delay for the movement of the robot relative the start of the CAP process,
- velocity for the CAP process,

The velocity is restricted by the performance of the robot. This differs, depending on the type of robot and the path of movement.

Components

fly_start

Data type: num

Not used.

start

Data type: num

Velocity (in mm/s) used at the start of the CAP process.

startspeed_time

Data type: num

The time (in seconds) to run at `start` velocity.

startmove_delay

Data type: num

The time (in seconds) that the robot movement is delayed relative the start of the CAP process.

main

Data type: num

The main CAP process velocity (mm/s).

fly_end

Data type: num

Not used.

Structure

```
< data object of capspeeddata >  
  < fly_start of num >  
  < start of num >  
  < startspeed_time of num >  
  < startmove_delay of num >  
  < main of num >  
  < fly_end of num >
```

Continues on next page

3.14 capspeeddata - Speed data for CAP *Continuous Application Platform (CAP)* *Continued*

Related information

	Described in:
capdata data type	capdata - CAP data on page 1614
<i>Continuous Application Platform</i>	<i>Application manual - Continuous Application Platform</i>

3 Data types

3.15 capstopmode - Defines stop modes for CAP *Continuous Application Platform (CAP)*

3.15 capstopmode - Defines stop modes for CAP

Usage

capstopmode is used to define the available stop modes in CAP.

Basic examples

The following example illustrates the data type capstopmode.

Example 1

```
CAPSetStopMode SMOOTH_STOP_ON_PATH;
```

Predefined values

Value	Description
SMOOTH_STOP_ON_PATH	The robot movement is stopped smoothly without leaving the programmed path.
QUICK_STOP_ON_PATH	The robot movement is stopped as fast as possible without leaving the programmed path.
EMERGENCY_STOP	The robot movement is stopped as fast as possible regardless if it leaves the programmed path.

Characteristics

capstopmode is an alias data type for num and consequently inherits its characteristics.

Related information

	Described in:
Instruction CAPSetStopMode	CAPSetStopMode - Set the stop mode for execution errors on page 126
<i>Continuous Application Platform</i>	<i>Application manual - Continuous Application Platform</i>

3.16 captrackdata - CAP track data

Usage

captrackdata provides the CapL/CapC instructions with all data necessary for path correction with a Look-Ahead- or At-Point-Tracker. The data is passed to the CapL/C instructions with use of the optional argument \Track.

The component device determines, which type of tracker is to be used.

captrackdata cannot be changed within a sequence of CapL/CapC instructions. The component device is set by the first CapL/C instruction - if it is different in the remaining CapL/C instructions of the same sequence of CapL/CapC instructions, it will not have any effect.

To be able to change the captrackdata to be used in a CapL/CapC instruction, the sequence has to be terminated first by setting the component last_inst to TRUE in capdata.

If the \Track is not present in the first CapL/C instruction and all following in the same sequence of CapL/CapC instructions, no correction will be applied.

Basic examples

SIO.cfg:

```
COM_TRP:
-Name "SCOUT:" -Type "RTP1"
-Name "digi-ip:" -Type "SOCKDEV" -PhyChannel "LAN1" -RemoteAdress
"192.168.125.5"
```

RAPID program:

```
PERS captrackdata captrack1 := ["digi-ip:",50,[1,10,1,0,0,0,0,0]];
CONST string laser := "digi-ip:";
PERS pose pose1 := [[137.867,-326.31,18.5],
[0.640984,0.766438,0.0348674,0.0223137]];
PROC main()
VAR pos sensorPos;
CapLATrSetup laser, pose1, pos \SensorFreq:=10 \CorrFilter:=5
\MaxBlind:=100 \MaxIncCorr:=2;
WriteVar laser, 6, 1;
! sensor ON
CapL p1, v200, cd, wsd_event, cwd, z20, tWeldGun
\Track:=captrack1;
CapC p2, p3, v200, cd2, wsd, cwd, z20, tWeldGun \Track:=captrack1;
CapL p4, v200, cd3, wsd, cwd, fine, tWeldGun \Track:=captrack1;
WriteVar laser, 6, 0;
! sensor OFF
ENDPROC
```

Components

device

Sensor device

Data type: string

Continues on next page

3 Data types

3.16 captrackdata - CAP track data

Continuous Application Platform (CAP)

Continued

Defines, to which device the sensor is connected, that shall be used in the CapL/CapC instructions to generate path corrections.

max_corr

Maximum allowed path correction

Data type: num

Defines the maximum path correction allowed.

For Look-Ahead trackers:

- If the TCP offset due to path corrections is more than max_corr and \WarnMaxCorr was specified in CapLAtSetup, the robot will continue its path but the applied path correction will not exceed max_corr.
- If \WarnMaxCorr was not specified, a track error is reported and program execution is stopped.

For At-Point trackers:

- If the TCP offset due to path corrections is more than max_corr, a track error is reported and program execution is stopped.

The figure shows the tool in a position relative to the programmed path where a max_corr track error would be reported. Unit: mm

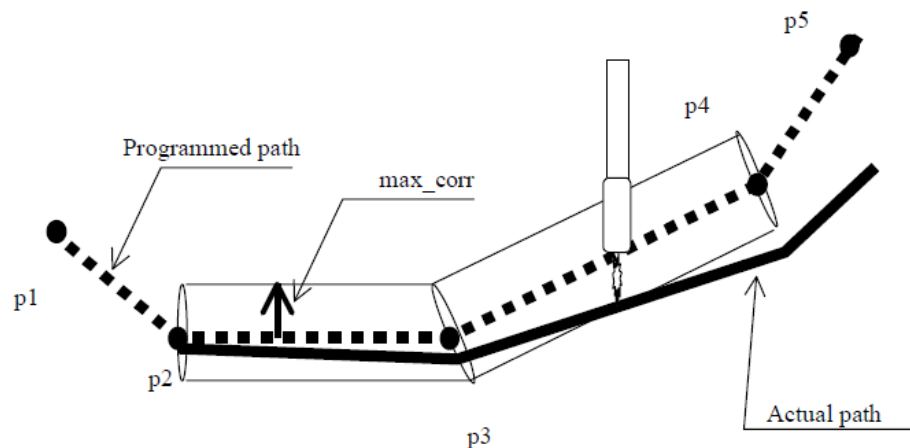

xx1200000198

la_trackdata

Look-Ahead-Tracker track data

Data type: caplatrackdata

Defines tracking data, that are specific for Look-Ahead-Trackers (for example, laser trackers).

Syntax

```
< data object of captrackdata >  
  < device of string >  
  < max_corr of num >  
  < la_trackdata of caplatrackdata >
```

Continues on next page

Related information

	Described in:
caplatrackdata	caplatrackdata - CAP Look-Ahead-Tracker track data on page 1618
CapAPTrSetup	CapAPTrSetup - Set up an At-Point-Tracker on page 80
CapLATrSetup	CapLATrSetup - Set up a Look-Ahead-Tracker on page 117
<i>Continuous Application Platform</i>	<i>Application manual - Continuous Application Platform</i>

3 Data types

3.17 capweavedata - Weavedata for CAP *Continuous Application Platform (CAP)*

3.17 capweavedata - Weavedata for CAP

Usage

`capweavedata` is used to define weaving for a CAP process during its MAIN phase (see *Application manual - Continuous Application Platform*).

Description of weaving

Weaving is superimposed on the basic path of the process. That means, that the process speed (defined in `capspeeddata`) is kept as defined, but the TCP speed is increased unless the physical robot limitations are reached.

Available weaving types:

- geometric weaving: most accurate shape
- wrist weaving: only robot axis 6 is used for weaving
- rapid weaving: geometric weaving but specifying weaving frequency instead of length
- rapid weaving axis 4-6: only robot axis 4, 5 and 6 are used for weaving

Available weaving shapes:

- Zig-zag weaving
- V-shaped weaving
- Triangular weaving
- Circular weaving

All `capweavedata` components apply to the MAIN phase.

Components

The path coordinate system is defined by:

- X: path/movement direction
- Z: tool z-direction
- Y: perpendicular to both X and Z as to build a right-handed coordinate system

active

Data type: `bool`

Value	Description
TRUE	Perform weaving during the MAIN phase of the CAP process
FALSE	Do NOT perform weaving during the MAIN phase of the CAP process

Continues on next page

width

Data type: num

For circular weaving, width is the radius of the circle (W in the following figure).
For all other weaving shapes, width is the total amplitude of the weaving pattern.

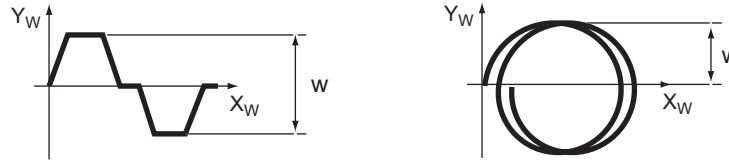

xx1200000721

shape

Data type: num

The shape of the weaving pattern in the main phase.

Value	Shape geometry	Result
0	No weaving	
1	Zig-zag weaving	Weaving horizontal to the seam xx1200000714
2	V-shaped weaving	Weaving in the shape of a "V", vertical to the seam xx1200000715
3	Triangular weaving	A triangular shape, vertical to the seam xx1200000716
4	Circular weaving (Only available with geometric weaving, weaving type 0)	A circular shape, vertical to the seam xx1200000717

type

Data type: num

Defines what axes are used for weaving during the MAIN phase

Specified value	Weaving type
0	Geometric weaving. All axes are used during weaving.
1	Wrist weaving. Mainly axis 4, 5 and 6 are used during weaving.
2	Rapid weaving. Mainly axis 4, 5 and 6 are used during weaving, but weaving frequency is specified instead of weaving length.
3	Rapid weaving, mainly with Axes 4, 5 and 6.

Continues on next page

3 Data types

3.17 capweavedata - Weavedata for CAP

Continuous Application Platform (CAP)

Continued

length

Data type: num

Defines the length of the weaving cycle in the MAIN phase for geometric weaving (type = 0) and wrist weaving (type = 1). The length argument is not used for the other weaving types.

For circular weaving the length component defines the distance between two successive circles (L) if the cycle_time argument is set to 0. The TCP rotates left with a positive length value, and right with a negative length value. If cycle_time has a value then length is not used.

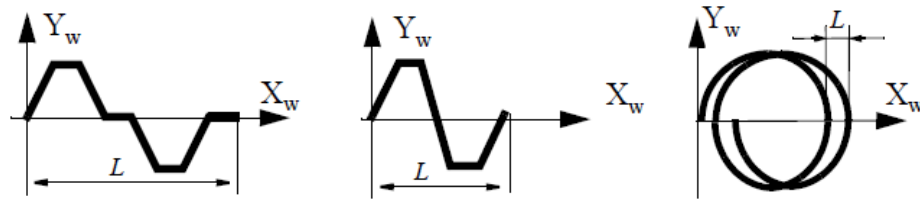

xx120000187

cycle_time

Data type: num

Defines the weaving frequency (in Hz) in the MAIN phase for of Rapid weaving types and for circular weaving. The cycle_time argument is not used for the other weaving types.

For circular weaving the cycle_time argument defines the number of circles per second. The TCP rotates left with a positive cycle_time value, and right with a negative cycle_time value. If cycle_time has a value then length is not used.

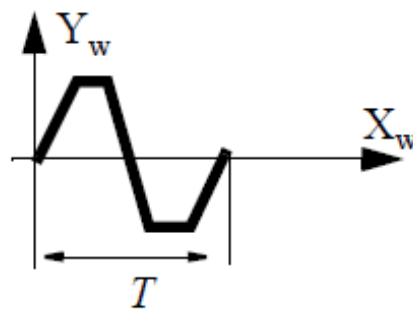

T = Weaving cycle time

f = Weaving frequency

$$f = \frac{1}{T}$$

xx120000188

height

Data type: num

Defines the height of the weaving pattern (in mm) during V-shaped and triangular weaving.

Continues on next page

Not available for circular weaving.

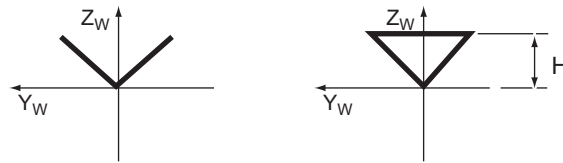

xx1200000722

dwel_left

Data type: num

The length of the dwell (DL) used to force the TCP to move only in the direction of the seam at the left turning point of the weave. Not available for circular weaving.

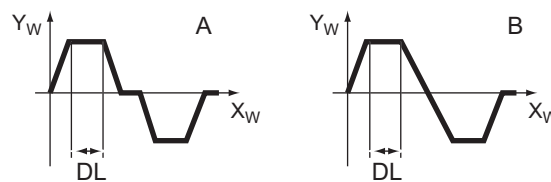

xx1200000723

A	Zigzag and V-shaped weaving
B	Triangular weaving

dwel_center

Data type: num

The length of the dwell (DC) used to force the TCP to move only in the direction of the seam at the center point of the weave. Not available for circular weaving.

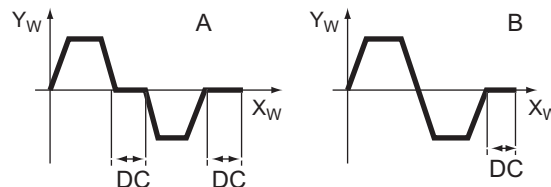

xx1200000724

A	Zigzag and V-shaped weaving
B	Triangular weaving

dwel_right

Data type: num

The length of the dwell (DR) used to force the TCP to move only in the direction of the seam at the right turning point of the weave. Not available for circular weaving.

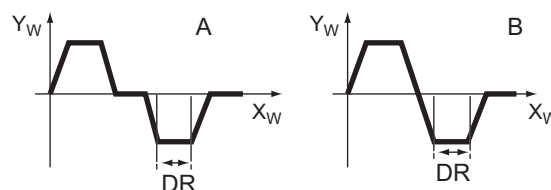

xx1200000725

Continues on next page

3 Data types

3.17 capweavedata - Weavedata for CAP

Continuous Application Platform (CAP)

Continued

A	Zigzag and V-shaped weaving
B	Triangular weaving

dir

Data type: num

The weave direction angle horizontal to the seam. An angle of zero degrees results in a weave vertical to the seam.



xx1200000726

tilt

Data type: num

The weave tilt angle, vertical to the seam. An angle of zero degrees results in a weave which is vertical to the seam.

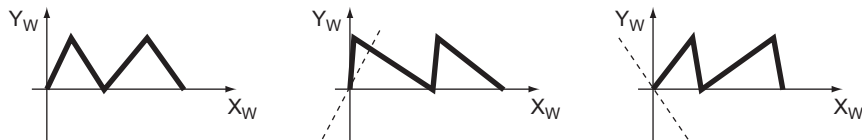

xx1200000727

rot

Data type: num

The weave orientation angle, horizontal-vertical to the seam. An angle of zero degrees results in symmetrical weaving.

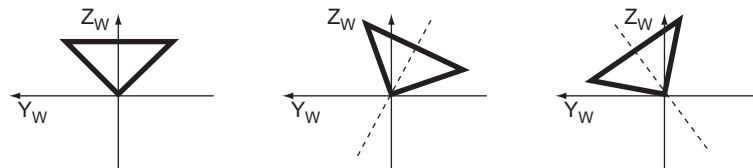

xx1200000728

bias

Data type: num

The bias horizontal to the weaving pattern. The bias can only be specified for zig-zag weaving and may not be greater than half the width of the weave. Not available for circular weaving.

The following figure shows zigzag weaving with and without bias (B).



xx1200000729

Continues on next page

ptrn_sync_on

Data type: bool

Value	Description
TRUE	Send synchronization pulses at the right and left turning points of the weave pattern
FALSE	Do NOT send synchronization pulses at the right and left turning points of the weave pattern

Limitations

The maximum weaving frequency is 2 Hz.

The inclination of the weaving pattern must not exceed the ratio 1:10 (84 degrees). See the following figure.

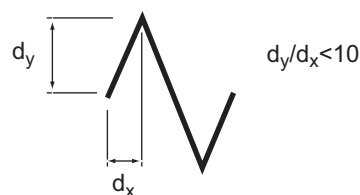

xx1200000730

Change of `weave_type` in `weavedata` is not possible in zone points, only in fine points. This is the behavior for both *TrueMove* and *QuickMove*, first and second generation.

All robots, that use *TrueMove* or *QuickMove* second generation have the following changed behavior for the different weaving types available in RW Arc, compared to *TrueMove* or *QuickMove* first generation:

- Geometric weaving - There is no change.
- Wrist weaving - uses mainly the wrist axes (4, 5, and 6) but small corrections can also be added to the main axes to be able to keep the pattern in the desired plane.
- Rapid weaving - In *TrueMove* or *QuickMove* second generation both geometric weaving and wrist weaving have highly improved performance. Therefore Rapid weaving (both types) is not necessary as a special weaving type any more.

Rapid weaving axis 1, 2, and 3 is the same as geometric weaving.

Rapid weaving axis 4, 5, and 6 is the same as wrist weaving.

The weaving types are still available for backward compatibility.

The system uses *TrueMove* or *QuickMove* second generation, if there is a switch `dyn_ipol_type 1` in `MOC.cfg` in the `MOTION_PLANNER` data (system parameters).

Syntax

```
< data object of capweavedata >
  < active of bool >
  < width of num >
  < shape of num >
```

Continues on next page

3 Data types

3.17 capweavedata - Weavedata for CAP

Continuous Application Platform (CAP)

Continued

< type of num >
< length of num >
< cycle_time of num >
< height of num >
< dwell_left of num >
< dwell_center of num >
< dwell_right of num >
< dir of num >
< tilt of num >
< rot of num >
< bias of num >
< ptrn_sync_on of bool >

Related information

	Described in:
capdata data type	capdata - CAP data on page 1614
<i>Continuous Application Platform</i>	<i>Application manual - Continuous Application Platform</i>

3.18 cfgdomain - Configuration domain

Usage

`cfgdomain` (*configuration domain*) is used to specify a configuration domain.

Description

Data of the type `cfgdomain` is intended to be used to define the configuration domain that shall be saved with instruction `SaveCfgData`.

Basic examples

The following example illustrates the data type `cfgdomain`:

Example 1

```
SaveCfgData "SYSPAR" \File:="MYEIO.cfg", EIO_DOMAIN;
```

Saving I/O domain configuration to the file `MYEIO.cfg` in directory `SYSPAR`.

Predefined data

The following predefined constants can be used to specify a configuration domain.

Name	Description
EIO_DOMAIN	I/O system configuration
MOC_DOMAIN	Motion configuration
SIO_DOMAIN	Communication domain
PROC_DOMAIN	Process domain
SYS_DOMAIN	Controller domain
MMC_DOMAIN	Man-machine communication
ALL_DOMAINS	All domains listed above

Characteristics

`cfgdomain` is an alias data type for `string` and consequently inherits its characteristics.

Related information

For information about	See
Save system parameters to file	SaveCfgData - Save system parameters to file on page 653
System parameters	<i>Technical reference manual - System parameters</i>

3 Data types

3.19 clock - Time measurement

RobotWare Base

3.19 clock - Time measurement

Usage

`clock` is used for time measurement. A clock functions like a stopwatch used for timing.

Description

Data of the type `clock` stores a time measurement in seconds and has a resolution of 0.001seconds.

Basic examples

The following example illustrates the data type `clock`:

Example 1

```
VAR clock myclock;  
ClkReset myclock;
```

The clock, `myclock`, is declared and reset. Before using `ClkReset`, `ClkStart`, `ClkStop`, and `ClkRead`, you must declare a variable of data type `clock` in your program.

Limitations

The maximum time that can be stored in a clock variable is approximately 49 days (4,294,967 seconds). The instructions `ClkStart`, `ClkStop`, and `ClkRead` report clock overflows in the very unlikely event that one occurs.

A clock must be declared as a `VAR` variable type, not as a persistent variable type.

Characteristics

`clock` is a non-value data type and cannot be used in value-oriented operations.

Related information

For information about	See
Summary of Time and Date Instructions	<i>Technical reference manual - RAPID Overview</i> , section <i>RAPID summary - System & time</i>
Non-value data type characteristics	<i>Technical reference manual - RAPID Overview</i> , section <i>Basic characteristics - Data types</i>

3.20 confdata - Robot configuration data

Usage

`confdata` is used to define the axis configurations of the robot.

Description

All positions of the robot are defined and stored using rectangular coordinates. When calculating the corresponding axis positions, there will often be two or more possible solutions. This means that the robot is able to achieve the same position, that is, the tool is in the same position and with the same orientation, with several different positions or configurations for the axes of the robot.

Some robots use iterative numerical methods to determine the robot axes positions. In these cases, the configuration parameters may be used to define good starting values for the joints to be used by the iterative procedure.

To unambiguously denote one of these possible configurations, the robot configuration is specified using four axis values. For a rotating axis, the value defines the current quadrant of the robot axis. The quadrants are numbered 0, 1, 2, and so on (they can also be negative). The quadrant number is connected to the current joint angle of the axis.

For 6-axis robots, quadrant 0 is the first quarter revolution, 0° to 90° , in a positive direction from the zero position; quadrant 1 is the next quarter revolution, 90° to 180° , and so on. Quadrant -1 is the quarter revolution 0° to (-90°) , and so on.

The figure shows the configuration quadrants for axis 1, 4, or 6 on a 6-axis robot, where the zero position is straight up.

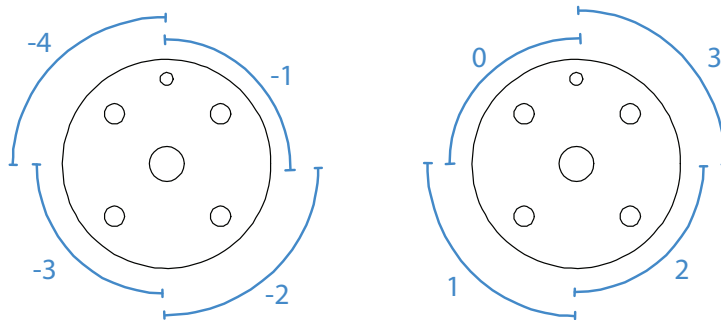

xx0500002398

For 7-axis robots, quadrant 0 is the quarter revolution centered around the zero position, -45° to $+45^\circ$; quadrant 1 is the next quarter revolution in positive direction, 45° to 135° , and so on. Quadrant -1 is the quarter revolution from -45° to -135° , and so on.

Continues on next page

3 Data types

3.20 confdata - Robot configuration data

RobotWare Base

Continued

The figure shows the configuration quadrants for axis 1, 4, or 6 on a 7-axis robot, where the zero position is straight up.

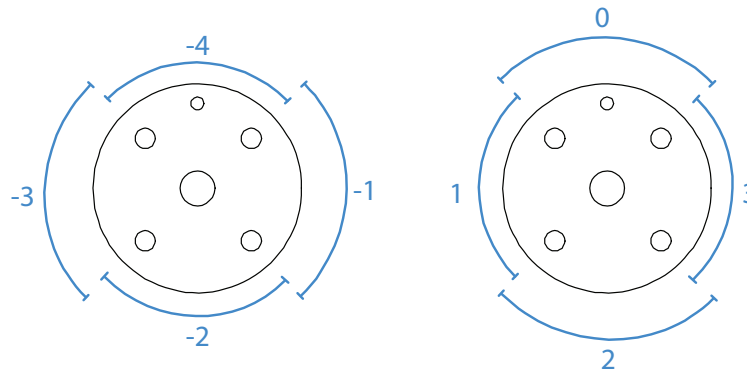

xx1700001572

For a linear axis, the value defines a meter interval for the robot axis. For each axis, value 0 means a position between 0 and 1 meters, and 1 means a position between 1 and 2 meters. For negative values, -1 means a position between -1 and 0 meters, and so on.

The figure shows configuration values for a linear axis.

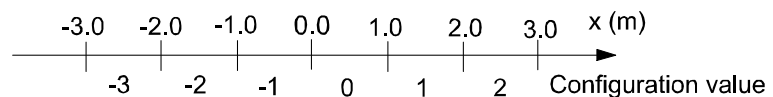

xx0500002399

Basic examples

The following example illustrates the data type `confdata`:

Example 1

```
VAR confdata conf15 := [1, -1, 0, 0]
```

A robot configuration `conf15` for a paint robot type is defined as follows:

- The axis configuration of the robot axis 1 is quadrant 1, i.e. 90-180°.
- The axis configuration of the robot axis 4 is quadrant -1, i.e. 0-(-90°).
- The axis configuration of the robot axis 6 is quadrant 0, i.e. 0 - 90°.
- The axis configuration of the robot axis 5 is quadrant 0, i.e. 0 - 90°.

Configuration supervision

For some robot models the configuration data (`confdata`) is also used to perform supervision of the programmed points for linear movements if `ConfL\On` is set.

No configuration supervision is performed with `ConfJ\On`, for more information see [ConfJ - Controls the configuration during joint movement on page 155](#).

Before an ordered movement is started, a verification is made to see if it is possible to achieve the programmed configuration. If it is not possible, the program is stopped. When the movement is finished (in a zone or in a finepoint), it is also verified that the robot has reached the programmed configuration.

Continues on next page

The configuration supervision with `ConfL\On` works differently for different robots. See the following sections for details.

6-axis serial link robots

The configuration supervision will check that axes 1, 4, and 6 will not move more than 180 degrees, and that the ordered movement does not require a change in `cfx`.

`cfx` is by default only used by serial link robots, not for parallel rod robots. For parallel rod robots, `cfx` can be enabled by setting the system parameter *Use cfx in robtargets for P-rod robots* to Yes.

4-axis serial link robots

The configuration supervision will check that axes 1 and 6 will not move more than 180 degrees.

Parallel arm robots (delta robots)

The configuration supervision will check that axis 4 will not move more than 180 degrees.

SCARA robots

The configuration supervision will check that axes 1 and 4 will not move more than 180 degrees. It will also check the sign of axis 2.

7-axis serial link robots

The configuration supervision will check that axes 1, 4, and 6 will not move more than 180 degrees, and that the ordered movement does not require a change in `cfx`.

Paint robots

No configuration supervision is done.

Robot configuration data

6-axis serial link robots

There are three singularities within the working range of the robot. For more information about singularities, see *Technical reference manual - RAPID Overview*.

- `cf1` is the quadrant number for axis 1.
- `cf4` is the quadrant number for axis 4.
- `cf6` is the quadrant number for axis 6.

`cfx` is used to select one of eight possible robot configurations numbered from 0 through 7. The following table describes each one of them in terms of how the robot is positioned relative to the three singularities.

<code>cfx</code>	Wrist center relative to axis 1	Wrist center relative to lower arm	Axis 5 angle
0	In front of	In front of	Positive
1	In front of	In front of	Negative
2	In front of	Behind	Positive
3	In front of	Behind	Negative

Continues on next page

3 Data types

3.20 confdata - Robot configuration data

RobotWare Base

Continued

<i>cfx</i>	Wrist center relative to axis 1	Wrist center relative to lower arm	Axis 5 angle
4	Behind	In front of	Positive
5	Behind	In front of	Negative
6	Behind	Behind	Positive
7	Behind	Behind	Negative

The following figures describe the eight different configurations with the same tool position and orientation.

The following figure shows an example of robot configuration 0 and 1. Note that because changing the sign of axis 5 also changes *cfx* one should avoid creating or doing ModPos of robtargets with axis 5 really close to zero. With axis 5 at zero, the measurement noise can cause the sign of the measured position of axis 5 to fluctuate and thereby giving an unpredictable value of *cfx*.

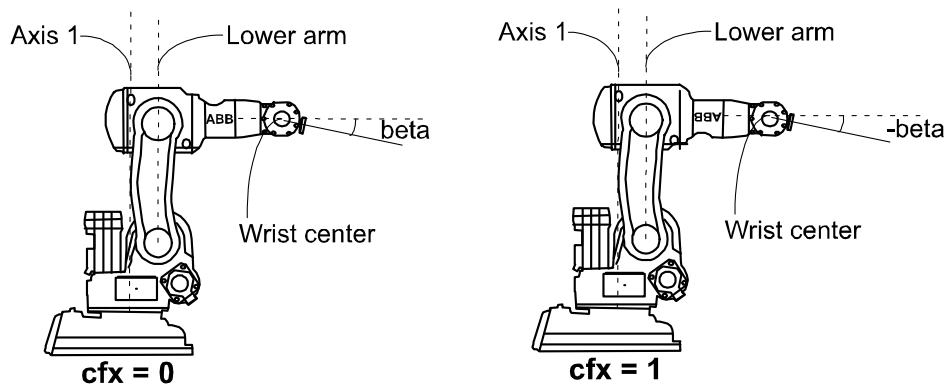

xx0500002400

The following figure shows an example of robot configuration 2 and 3. Note the different signs of the axis 5 angle.

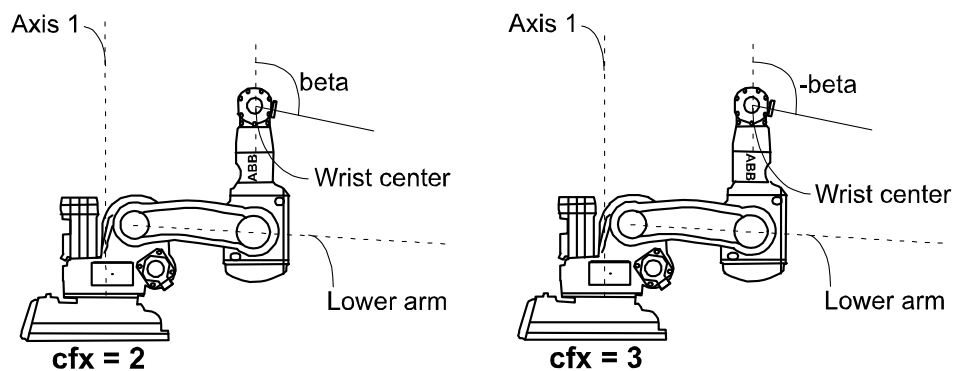

xx0500002401

Continues on next page

The following figure shows an example of robot configuration 4 and 5. Note the different signs of the axis 5 angle.

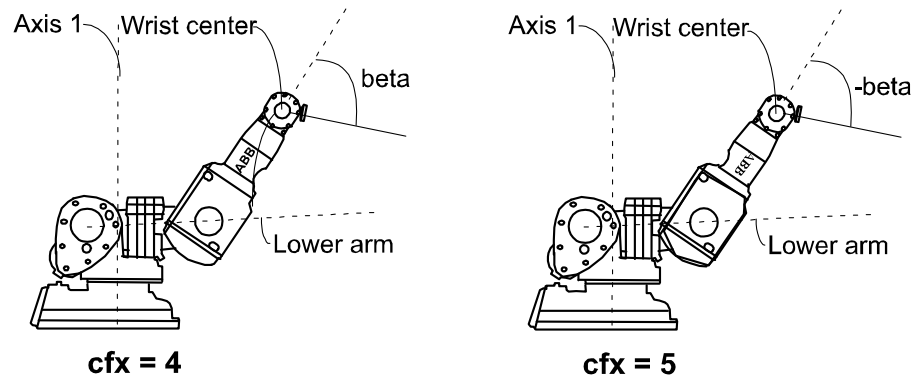

xx0500002402

The following figure shows an example of robot configuration 6 and 7. Note the different signs of the axis 5 angle.

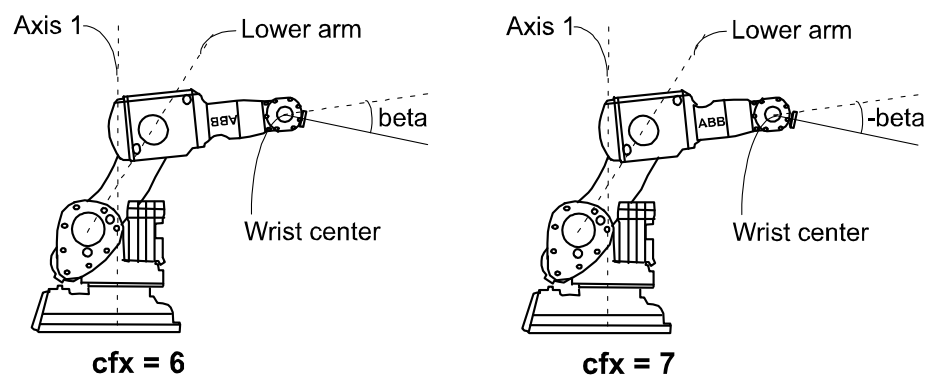

xx0500002403

6-axis robots with parallel rod

Only the three configuration parameters `cf1`, `cf4`, and `cf6` are used, unless the system parameter *Use cfx in robtargets for P-rod robots* is set to *Yes*.

4-axis serial link robots

Only the configuration parameter `cf6` is used.

Parallel arm robots (delta robots)

Only the configuration parameter `cf4` is used.

SCARA robots (not inverted)

Only the three configuration parameters `cf1`, `cf4`, and `cfx` are used.

The `cfx` value is used to display the sign of the axis 2 angle. `cfx` is 1 if the axis 2 angle is negative, otherwise `cfx` is 0.

Continues on next page

3 Data types

3.20 confdata - Robot configuration data

RobotWare Base

Continued

7-axis serial link robots

All four configuration parameters are used. `cf1`, `cf4`, `cf6` for joints 1, 4, and 6 respectively. `cfx` is used to select one of 8 possible robot configurations similar to how it works for other robots.

<code>cfx</code>	Axis 2 angle	Wrist center relative to lower arm	Axis 5 angle
0	Positive	In front of	Positive
1	Positive	In front of	Negative
2	Positive	Behind	Positive
3	Positive	Behind	Negative
4	Negative	In front of	Positive
5	Negative	In front of	Negative
6	Negative	Behind	Positive
7	Negative	Behind	Negative

Paint robots

All four configuration parameters are used. `cf1`, `cf4`, `cf6` for joints 1, 4, and 6 respectively and `cfx` for joint 5.

IRB 5500

All four configuration parameters are used. `cf1`, `cf4`, `cf6` for joints 1, 4, and 6 respectively. The `cfx` parameter contains a combination of the joint 5 quadrant number and the four possible configurations for axes 2 and 3.

For more information see the *Product Manual - IRB 5500*.

IRB 5350

The robot have two rotation axes (arms 1 and 2) and one linear axis (arm 3).

- `cf1` is used for the rotating axis 1
- `cfx` is used for the rotating axis 2
- `cf4` and `cf6` are not used

Components

`cf1`

Data type: num

Rotating axis:

The current quadrant of axis 1, expressed as a positive or negative integer.

Linear axis:

The current meter interval of axis 1, expressed as a positive or negative integer.

`cf4`

Data type: num

Rotating axis:

The current quadrant of axis 4, expressed as a positive or negative integer.

Linear axis:

Continues on next page

The current meter interval of axis 4, expressed as a positive or negative integer.

cf6

Data type: num

Rotating axis:

The current quadrant of axis 6, expressed as a positive or negative integer.

Linear axis:

The current meter interval of axis 6, expressed as a positive or negative integer.

cfx

Data type: num

Rotating axis:

For serial link robots, the current robot configuration, expressed as an integer in the range from 0 to 7.

For SCARA robots (not inverted versions), the current robot configuration, expressed as an integer in the range from 0 to 1, see [SCARA robots \(not inverted\) on page 1641](#).

For 7-axis robots, the the current robot configuration, expressed as an integer in the range from 0 to 7, see [7-axis serial link robots on page 1642](#).

For paint robots, the current quadrant of axis 5, expressed as a positive or negative integer. For IRB 5500, see [IRB 5500 on page 1642](#).

For other robots, using the current quadrant of axis 2, expressed as a positive or negative integer.

Linear axis:

The current meter interval of axis 2, expressed as a positive or negative integer.

Structure

```
< dataobject of confdata >
  < cf1 of num >
  < cf4 of num >
  < cf6 of num >
  < cfx of num >
```

Related information

For information about	See
Coordinate systems Handling configuration data Singularities	<i>Technical reference manual - RAPID Overview</i>
Position data	robtaraget - Position data on page 1734
System parameters	<i>Technical reference manual - System parameters</i>

3 Data types

3.21 corrdescr - Correction generator descriptor

Path Offset

3.21 corrdescr - Correction generator descriptor

Usage

`corrdescr` (*Correction generator descriptor*) is used by correction generators. A correction generator adds geometric offsets in the path coordinate system.

Description

Data of the type `corrdescr` contains a reference to a correction generator. Connection to a correction generator is done by the instruction `CorrCon` and the descriptor (the reference to the correction generator) can be used to deliver geometric offsets in the path coordinate system with the instruction `CorrWrite`. Offsets provided earlier can be removed by disconnecting a correction generator with the instruction `CorrDiscon`. All connected correction generators can be removed with the instruction `CorrClear`.

The function `CorrRead` returns the sum of all the delivered offsets so far (includes all connected correction generators).

Basic examples

The following example illustrates the data type `corrdescr`:

Example 1

```
VAR corrdescr id;
VAR pos offset;
...
CorrCon id;
offset := [1, 2 ,3];
CorrWrite id, offset;
```

A correction generator is connected with the instruction `CorrCon` and referenced by the descriptor `id`. Offsets are then delivered to the correction generator (with reference `id`) using the instruction `CorrWrite`.

Characteristics

`corrdescr` is a non-value data type.

Related information

For information about	See
Connects to a correction generator	CorrCon - Connects to a correction generator on page 174
Disconnects from a correction generator	CorrDiscon - Disconnects from a correction generator on page 179
Writes to a correction generator	CorrWrite - Writes to a correction generator on page 180
Reads the current total offsets	CorrRead - Reads the current total offsets on page 1224
Removes all correction generators	CorrClear - Removes all correction generators on page 173

Continues on next page

For information about	See
Characteristics of non-value data types	<i>Technical reference manual - RAPID Overview, section Basic characteristics - Data types</i>

3 Data types

3.22 datapos - Enclosing block for a data object

RobotWare Base

3.22 datapos - Enclosing block for a data object

Usage

`datapos` is the enclosing block to a data object (internal system data) retrieved with the function `GetNextSym`.

Description

Data of the type `datapos` contains information of where a certain object is defined in the system. It is used for instructions `GetDataVal` and `SetDataVal`.

Basic examples

The following example illustrates the data type `datapos`:

Example 1

```
VAR datapos block;
VAR string name;
VAR bool truevar:=TRUE;
...
SetDataSearch "bool" \Object:="my.*" \InMod:="mymod"\LocalSym;
WHILE GetNextSym(name,block) DO
    SetDataVal name\Block:=block,truevar;
ENDWHILE
```

This session will set all local `bool` data objects that begin with `my` in the module `mymod` to `TRUE`.

Characteristics

`datapos` is a non-value data type.

Related information

For information about	See
Define a symbol set in a search session	SetDataSearch - Define the symbol set in a search sequence on page 696
Get next matching symbol	GetNextSym - Get next matching symbol on page 1299
Get the value of a data object	GetDataVal - Get the value of a data object on page 229
Set the value of a data object	SetDataVal - Set the value of a data object on page 701
Set the value of many object	SetAllDataVal - Set a value to all data objects in a defined set on page 692
<i>Advanced RAPID</i>	<i>Product specification - Controller software IRC5</i>

3.23 dionum - Digital values (0-1)

Usage

`dionum`(*digital input output numeric*) is used for digital values (0 or 1).

This data type is used in conjunction with instructions and functions that handle digital input or output signals.

Description

Data of the type `dionum` represents a digital value 0 or 1.

Basic examples

The following example illustrates the data type `dionum`:

Example 1

```
CONST dionum close := 1;
SetDO gripl, close;
```

Definition of a constant `close` with a value equal to 1. The signal `gripl` is then set to `close`, i.e. 1.

Predefined data

The constants `high`, `low`, and `edge` are predefined in the system:

```
CONST dionum low:=0;
CONST dionum high:=1;
CONST dionum edge:=2;
```

The constants `low` and `high` are designed for I/O instructions.

`Edge` can be used together with the interrupt instructions `ISignalDI` and `ISignalDO`.

Characteristics

`dionum` is an alias data type for `num` and consequently inherits its characteristics.

Related information

For information about	See
Summary input/output instructions	<i>Technical reference manual - RAPID Overview, section RAPID Summary - Input and output signals</i>
Configuration of I/O	<i>Technical reference manual - System parameters</i>
Alias data types	<i>Technical reference manual - RAPID Overview, section Basic Characteristics- Data types</i>

3 Data types

3.24 dir - File directory structure

RobotWare Base

3.24 dir - File directory structure

Usage

`dir` (*directory*) is used to traverse directory structures.

Description

Data of the type `dir` contains a reference to a directory on disk or network. It can be linked to the physical directory by means of the instruction `OpenDir` and then used for reading.

Basic examples

The following example illustrates the data type `dir`:

Example 1

```
PROC lsdire(string dirname)
  VAR dir directory;
  VAR string filename;
  OpenDir directory, dirname;
  WHILE ReadDir(directory, filename) DO
    TPWrite filename;
  ENDWHILE
  CloseDir directory;
ENDPROC
```

This example prints out the names of all files or subdirectories under the specified directory.

Characteristics

`dir` is a non-value data type and cannot be used in value-oriented operations.

Related information

For information about	See
Open a directory	OpenDir - Open a directory on page 503
Make a directory	MakeDir - Create a new directory on page 353
Read a directory	ReadDir - Read next entry in a directory on page 1426
Close a directory	CloseDir - Close a directory on page 152
Remove a directory	RemoveDir - Delete a directory on page 602
Remove a file	RemoveFile - Delete a file on page 604
Rename a file	RenameFile - Rename a file on page 607
Check file type	IsFile - Check the type of a file on page 1343
File and I/O device handling	Application manual - Controller software IRC5

3.25 dnum - Double numeric values

Usage

`dnum` is used for numeric values, for example counters. It can handle larger integer values than data type `num` but its characteristics and function is the same as for `num`.

Description

The value of the `dnum` data type can be:

- An integer, for example -5
- A decimal number, for example 3.45

It can also be written exponentially, for example 2E3 (= $2 \cdot 10^3 = 2000$), 2.5E-2 (= 0.025).

Integers between -4503599627370496 and +4503599627370496 are always stored as exact integers.

Basic examples

The following examples illustrate the data type `dnum`:

Example 1

```
VAR dnum reg1;
...
reg1:=1000000;
reg1 is assigned the value 1000000.
```

Example 2

```
VAR dnum hex;
Var dnum bin;
VAR dnum oct;
! Hexadecimal representation of decimal value 4294967295
hex := 0xFFFFFFFF;
! Binary representation of decimal value 255
bin := 0b11111111;
! Octal representation of decimal value 255
oct := 0o377;
```

Example 3

```
VAR dnum a:=0;
VAR dnum b:=0;
a := 10 DIV 3;
b := 10 MOD 3;
```

Integer division where `a` is assigned an integer (=3) and `b` is assigned the remainder (=1).

Limitations

Literal values between -4503599627370496 to 4503599627370496 assigned to a `dnum` variable are stored as exact integers.

Continues on next page

3 Data types

3.25 dnum - Double numeric values

RobotWare Base

Continued

If a literal value that has been interpreted as a `num` is assigned/used as a `dnum`, it is automatically converted to a `dnum`.

Related information

For information about	See
Numeric values using data type <code>num</code>	num - Numeric values on page 1698
Numeric expressions	<i>Technical reference manual - RAPID overview, section Basic RAPID programming</i>
Operations using numeric values	<i>Technical reference manual - RAPID overview, section Basic RAPID programming</i>

3.26 errdomain - Error domain

Usage

`errdomain` (*error domain*) is used to specify an error domain.

Description

Data of the type `errdomain` represents the domain where the error, warning, or state changed is logged.

Basic examples

The following example illustrates the data type `errdomain`:

Example 1

```

VAR errdomain err_domain;
VAR num err_number;
VAR errtype err_type;
VAR trapdata err_data;
...
TRAP trap_err
  GetTrapData err_data;
  ReadErrData err_data, err_domain, err_number, err_type;
ENDTRAP

```

When an error is trapped to the trap routine `trap_err`, the error domain, the error number, and the error type are saved into appropriate variables.

Predefined data

The following predefined constants can be used to specify an error domain.

Name	Error Domain	Value
COMMON_ERR	All error and state changed domains	0
OP_STATE	Operational state change	1
SYSTEM_ERR	System errors	2
HARDWARE_ERR	Hardware errors	3
PROGRAM_ERR	Program errors	4
MOTION_ERR	Motion errors	5
OPERATOR_ERR	Operator errors - Obsolete, not used anymore	6
IO_COM_ERR	I/O and Communication errors	7
USER_DEF_ERR	User defined errors (raised by RAPID)	8
SAFETY_ERR	Safety related events	9
PROCESS_ERR	Process errors	11
CFG_ERR	Configuration error	12

Characteristics

`errdomain` is an alias data type for `num` and consequently inherits its characteristics.

Continues on next page

3 Data types

3.26 errdomain - Error domain

RobotWare Base

Continued

Related information

For information about	See
Ordering an interrupt on errors	!Error - Orders an interrupt on errors on page 255
Error numbers	<i>Operating manual - Troubleshooting IRC5</i>
Alias data types	<i>Technical reference manual - RAPID Overview</i>
<i>Advanced RAPID</i>	<i>Product specification - Controller software IRC5</i>

3.27 errnum - Error number

Usage

`errnum` is used to describe all recoverable (non fatal) errors that occur during program execution, such as division by zero.

Description

If the robot detects an error during program execution, this can be dealt with in the error handler of the routine. Examples of such errors are values that are too high and division by zero. The system variable `ERRNO`, of type `errnum`, is thus assigned different values depending on the nature of an error. The error handler may be able to correct an error by reading this variable and then program execution can continue in the correct way.

An error can also be created from within the program using the `RAISE` instruction. This particular type of error can be detected in the error handler by specifying an error number (within the range 1-90 or booked with instruction `BookErrNo`) as an argument to `RAISE`.

Basic examples

The following examples illustrate the data type `errnum`:

Example 1

```
reg1 := reg2 / reg3;
...
ERROR
  IF ERRNO = ERR_DIVZERO THEN
    reg3 := 1;
    RETRY;
  ENDIF
```

If `reg3 = 0`, the robot detects an error when division is taking place. This error, however, can be detected and corrected by assigning `reg3` the value 1. Following this, the division can be performed again and program execution can continue.

Example 2

```
CONST errnum machine_error := 1;
...
IF dil=0 RAISE machine_error;
...
ERROR
  IF ERRNO=machine_error RAISE;
```

An error occurs in a machine (detected by means of the input signal `dil`). A jump is made to the error handler in the routine which, in turn, calls the error handler of the calling routine where the error may possibly be corrected. The constant, `machine_error`, is used to let the error handler know exactly what type of error has occurred.

Continues on next page

3 Data types

3.27 errnum - Error number

RobotWare Base

Continued

Predefined data

The system variable `ERRNO` can be used to read the latest error that occurred. A number of predefined constants can be used to determine the type of error that has occurred.

Name	Cause of error
<code>ERR_ACC_TOO_LOW</code>	Too low acceleration/deceleration specified in instruction <code>PathAccLim</code> or <code>WorldAccLim</code> .
<code>ERR_ACTIV_PROF</code>	Error in the activated profile.
<code>ERR_ALIASCAM_DEF</code>	The camera in argument <code>CameraName</code> or the <code>cameradev</code> used in argument <code>FromCamera</code> is not defined in the system parameter Communication configuration. Or the <code>ToCamera</code> is not declared in the RAPID program or is already defined in the system parameter Communication configuration.
<code>ERR_ALIASIO_DEF</code>	The <code>FromSignal</code> is not defined in the I/O configuration or the <code>ToSignal</code> is not declared in the RAPID program or is defined in the I/O configuration. Instruction <code>AliasIO</code> .
<code>ERR_ALIASIO_TYPE</code>	The signal types for the arguments <code>FromSignal</code> and <code>ToSignal</code> is not the same (signalx). Instruction <code>AliasIO</code> .
<code>ERR_ALRDY_MOVING</code>	The robot is already moving when executing a <code>StartMove</code> or <code>StartMoveRetry</code> instruction.
<code>ERR_ALRDYCNT</code>	The interrupt variable is already connected to a trap routine.
<code>ERR_AO_LIM</code>	Analog signal value outside limit
<code>ERR_ARGDUPCND</code>	More than one present conditional argument for the same parameter
<code>ERR_ARGNAME</code>	Argument is an expression, not present, or of type <code>switch</code> when executing <code>ArgName</code> .
<code>ERR_ARGNOTPER</code>	Argument is not a persistent reference.
<code>ERR_ARGNOTVAR</code>	Argument is not a variable reference.
<code>ERR_ARGVALERR</code>	Argument value error.
<code>ERR_AXIS_ACT</code>	Axis is not active.
<code>ERR_AXIS_IND</code>	Axis is not independent.
<code>ERR_AXIS_MOVING</code>	Axis is moving.
<code>ERR_AXIS_PAR</code>	Parameter axis in instruction or function is wrong.
<code>ERR_BUSSTATE</code>	An <code>IOEnable</code> is done, and the I/O network is in error state or enter error state before the I/O device is activated.
<code>ERR_BWDLIMIT</code>	Limit <code>StepBwdPath</code> .
<code>ERR_CALC_DIVZERO</code>	<code>StrDig</code> division by zero.
<code>ERR_CALC_NEG</code>	<code>StrDig</code> negative calculation error.
<code>ERR_CALC_OVERFLOW</code>	<code>StrDig</code> calculation overflow.
<code>ERR_CALLPROC</code>	Procedure call error (not procedure) at runtime (late binding).
<code>ERR_CAM_BUSY</code>	The camera is busy with some other request and cannot perform the current order.
<code>ERR_CAM_COM_TIMEOUT</code>	The communication towards the camera timed out. The camera is not responding.

Continues on next page

Name	Cause of error
ERR_CAM_GET_MISMATCH	The parameter fetched from the camera with instruction <code>CamGetParameter</code> has the wrong data type.
ERR_CAM_MAXTIME	Timeout when executing a <code>CamLoadJob</code> or a <code>CamGetResult</code> instruction.
ERR_CAM_NO_MORE_DATA	No more vision results can be fetched.
ERR_CAM_NO_PROGMODE	The camera is not in program mode.
ERR_CAM_NO_RUNMODE	The camera is not in running mode.
ERR_CAM_NOT_ON_NETWORK	The camera is not connected.
ERR_CAM_SET_MISMATCH	The parameter written to the camera with instruction <code>CamSetParameter</code> has the wrong data type, or the value is out of range.
ERR_CFG_ILL_DOMAIN	The <code>cfgdomain</code> used in instruction <code>SaveCfgData</code> is invalid or not in use.
ERR_CFG_ILLTYPE	Type mismatch - <code>ReadCfgData</code> , <code>WriteCfgData</code> .
ERR_CFG_INTERNAL	Not allowed to read or write internal parameter.
ERR_CFG_LIMIT	Data limit - <code>WriteCfgData</code> .
ERR_CFG_NOTFND	Not found - <code>ReadCfgData</code> , <code>WriteCfgData</code> .
ERR_CFG_OUTOFBOUNDS	If <code>ListNo</code> is -1 at input or bigger then number of available instances - <code>ReadCfgData</code> , <code>WriteCfgData</code> .
ERR_CFG_WRITEFILE	The directory does not exist, or the <code>FilePath</code> and <code>File</code> used is a directory, or some other problem regarding saving the file when using instruction <code>SaveCfgData</code> .
ERR_CNTNOTVAR	CONNECT target is not a variable reference.
ERR_CNV_CONNECT	The <code>WaitWObj</code> instruction is already active.
ERR_CNV_DROPPED	The object that the instruction <code>WaitWObj</code> was waiting for has been dropped.
ERR_CNV_NOT_ACT	The conveyor is not activated.
ERR_CNV_OBJ_LOST	The object that the instruction <code>WaitWObj</code> or <code>WaitSensor</code> was waiting for has passed the <code>StartwindowWidth</code> without being connected.
ERR_COLL_STOP	Stop of the movement because of motion collision.
ERR_COMM_INIT	Communication interface could not be initialized.
ERR_CONC_MAX	The number of movement instructions in succession using argument <code>\Conc</code> has been exceeded.
ERR_DEV_MAXTIME	Timeout when executing a <code>ReadBin</code> , <code>ReadNum</code> , <code>ReadStr</code> , <code>ReadStrBin</code> , <code>ReadAnyBin</code> , or a <code>ReadRawBytes</code> instruction.
ERR_DIPLAG_LIM	Too big <code>DipLag</code> in the instruction <code>TriggSpeed</code> connected to current <code>TriggL/TriggC/TriggJ/CapL/CapC</code> .
ERR_DIVZERO	Division by zero.
ERR_EXCRTYMAX	Maximum number of retries exceeded. <code>RAISE</code> or <code>TRYNEXT</code> can be used to handle this error.
ERR_EXECPHR	An attempt was made to execute an instruction using a place holder.

Continues on next page

3 Data types

3.27 errnum - Error number

RobotWare Base

Continued

Name	Cause of error
ERR_FILEACC	A file is accessed incorrectly.
ERR_FILEEXIST	A file already exists.
ERR_FILEOPEN	A file cannot be opened.
ERR_FILNOTFND	File not found.
ERR_FIT_NOT_PLANE	Points are not on a plane. <code>FitPlane</code> and <code>FitCircle</code> instructions.
ERR_FIT_NUMPOINTS	Parameter <code>NumPoints</code> larger than array <code>Points</code> . All <code>FitX</code> instructions.
ERR_FIT_POINTS_IN_LINE	Identical points or collinear points. <code>FitPlane</code> , <code>FitCircle</code> , and <code>FitSphere</code> instructions.
ERR_FIT_POINTS_NOT_LINE	Points are not along a line (planar or spherical distribution). <code>FitLine</code> instruction.
ERR_FIT_POINTS_TOO_CLOSE	Identical points and $n=2$. <code>FitLine</code> instruction.
ERR_FIT_TOO_FEW_POINTS	Too few points. All <code>FitX</code> instructions.
ERR_FIT_TOO_MANY_POINTS	Too many points. <code>FitCircle</code> and <code>FitSphere</code> instructions.
ERR_FNCNORET	No return value.
ERR_FRAME	Unable to calculate new frame.
ERR_GO_LIM	Digital group signal value outside limit.
ERR_ILLDIM	Incorrect array dimension.
ERR_ILLQUAT	Attempt to use illegal orientation (quaternion) value.
ERR_ILLRAISE	Error number in <code>RAISE</code> out of range.
ERR_INDCNV_ORDER	An instruction requires execution of <code>IndCnvInit</code> before it is executed.
ERR_INOISSAFE	If trying to deactivate a safe interrupt temporarily with <code>ISleep</code> .
ERR_INOMAX	No more interrupt numbers available.
ERR_INT_MAXVAL	Not valid integer, too large or small value.
ERR_INT_NOTVAL	Not valid integer, decimal value.
ERR_INVDIM	Dimensions are not equal.
ERR_IODISABLE	Time-out when executing <code>IODisable</code> .
ERR_IOENABLE	Time-out when executing <code>IOEnable</code> .
ERR_IOERROR	I/O Error from instruction <code>Save</code> , <code>Load</code> and <code>WaitLoad</code> .
ERR_LINKREF	Reference error in the program task.
ERR_LOADED	The program module is already loaded.
ERR_LOADID_FATAL	Only internal use in <code>LoadId</code> and <code>ManLoadIdProc</code> .
ERR_LOADID_RETRY	Only internal use in <code>LoadId</code> .
ERR_LOADNO_INUSE	The load session is in use in <code>StartLoad</code> .
ERR_LOADNO_NOUSE	The load session is not in use in <code>CancelLoad</code> .

Continues on next page

Name	Cause of error
ERR_MOD_NOT_LOADED	The module does not exist, the symbol is not a module or the name was too long for being a symbol. Error from function <code>ModTimeDnum</code> .
ERR_MODULE	Incorrect module name in instruction <code>Save</code> and <code>EraseModule</code> .
ERR_NAME_INVALID	The I/O device name does not exist.
ERR_NO_ALIASIO_DEF	The signal variable is a variable declared in RAPID. It has not been connected to an I/O signal defined in the I/O configuration with instruction <code>AliasIO</code> .
ERR_NO_SGUN	The specified servo tool name is not a configured servo tool.
ERR_NORUNUNIT	There is no contact with the I/O device.
ERR_NOT_MOVETASK	Specified task is a non-motion task.
ERR_NOTARR	Data is not an array.
ERR_NOTEQDIM	The array dimension used when calling the routine does not coincide with its parameters.
ERR_NOTINTVAL	Not an integer value.
ERR_NOTPRES	A parameter is used, despite the fact that the corresponding argument was not used at the routine call.
ERR_NOTSAVED	Module has been changed since it was loaded into the system.
ERR_NUM_LIMIT	Value is above $3.40282347E+38$ or below $-3.40282347E+38$.
ERR_ORIENT_VALUE	Wrong orientation value in <code>NOrient</code> function.
ERR_OUTOFBND	The array index is outside the permitted limits.
ERR_OUTSIDE_REACH	The position (<code>robtargt</code>) is outside the robot's working area for function <code>CalcJoinT</code> .
ERR_OVERFLOW	Clock overflow.
ERR_PATH	Missing destination path in instruction <code>Save</code> .
ERR_PATH_STOP	Stop of the movement because of some process error.
ERR_PATHDIST	Too long regain distance for <code>StartMove</code> , <code>StartMoveRetry</code> or <code>SetLeadThrough</code> instruction.
ERR_PERSSUPSEARCH	The persistent variable is already TRUE at the beginning of the search process.
ERR_PID_MOVESTOP	Only internal use in <code>LoadId</code> and <code>ManLoadIdProc</code> .
ERR_PID_RAISE_PP	Error from <code>ParIdRobValid</code> , <code>ParIdPosValid</code> , <code>LoadId</code> or <code>ManLoadIdProc</code> .
ERR_PRGMEMFULL	Program memory full.
ERR_PROCSIGNAL_OFF	Process signal is off.
ERR_PROGSTOP	The robot is in program stop state when executing a <code>StartMove</code> , <code>StartMoveRetry</code> or <code>SetLeadThrough</code> instruction.
ERR_RANYBIN_CHK	Check sum error detected at data transfer with instruction <code>ReadAnyBin</code> .

Continues on next page

3 Data types

3.27 errnum - Error number

RobotWare Base

Continued

Name	Cause of error
ERR_RANYBIN_EOF	End of file is detected before all bytes are read in instruction <code>ReadAnyBin</code> or <code>ReadRawBytes</code> .
ERR_RCVDATA	An attempt was made to read non-numeric data with <code>ReadNum</code> .
ERR_REFUNKDAT	Reference to entire unknown data object.
ERR_REFUNKFUN	Reference to unknown function.
ERR_REFUNKPRC	Reference to unknown procedure at linking time or at run time (late binding).
ERR_REFUNKTRP	Reference to unknown trap.
ERR_RMQ_DIM	Wrong dimensions, the dimensions of the given data are not equal to the dimensions of the data in the message.
ERR_RMQ_FULL	Destination message queue is full.
ERR_RMQ_INVALID	Destination slot lost or invalid.
ERR_RMQ_INVMSG	Invalid message, likely sent from other client than a RAPID task.
ERR_RMQ_MSGSIZE	Size of message is too big. Decrease message size.
ERR_RMQ_NAME	The given slot name is not valid or not found.
ERR_RMQ_NOMSG	No message in queue, likely the results of power fail.
ERR_RMQ_TIMEOUT	Time-out occurred while waiting for answer in <code>RMQSendWait</code> or <code>RMQReadWait</code> .
ERR_RMQ_VALUE	The value syntax does not match the data type.
ERR_ROBLIMIT	The position is reachable, but at least one axis is outside the joint limits or limits exceeded for at least one coupled joint (function <code>CalcJointT</code>).
ERR_SC_WRITE	Error when sending to external computer.
ERR_SGUN_ESTOP	Emergency stop during servo tool movement.
ERR_SGUN_MOTOFF	The instruction is invoked from a background task and the system is in motors off state.
ERR_SGUN_NEGVAL	The argument <code>PrePos</code> is specified with a value less than zero.
ERR_SGUN_NOTACT	The servo tool mechanical unit is not activated.
ERR_SGUN_NOTINIT	The servo tool position is not initialized.
ERR_SGUN_NOTOPEN	The gun is not open when the instruction is invoked.
ERR_SGUN_NOTSYNC	The servo tool tips are not synchronized.
ERR_SIG_NOT_VALID	The I/O signal cannot be accessed. The reasons can be that the I/O device is not running or an error in the configuration (only valid for ICI field bus).
ERR_SIGSUPSEARCH	The signal has already a positive value at the beginning of the search process.
ERR_SOCKET_ADDR_INUSE	The address and port is already in use and can not be used again. Use a different port number or address in <code>SocketBind</code> .
ERR_SOCKET_ADDR_INVALID	The specified address is invalid.

Continues on next page

Name	Cause of error
ERR_SOCKET_CLOSED	The socket is closed, or is not created.
ERR_SOCKET_EXEC_LEVEL	Use of socket instructions on different RAPID execution levels at the same time, that is, normal execution level and TRAP level.
ERR_SOCKET_IS_BOUND	The socket has already been bound to an address and cannot be bound again.
ERR_SOCKET_IS_CONN	The socket is connected.
ERR_SOCKET_NET_UNREACH	Network is unreachable or connection is lost after a socket is opened.
ERR_SOCKET_NOT_BOUND	The socket has not been bound to an address.
ERR_SOCKET_NOT_CONN	The socket is not connected
ERR_SOCKET_TIMEOUT	The connection was not established within the time-out time, or no data was received within the time out time.
ERR_SOCKET_UNSPEC	Unspecified exception from underlying call to the operating system.
ERR_SPEED_REFRESH_LIM	Override out of limit in SpeedRefresh.
ERR_SPEEDLIM_VALUE	The speed used in instructions SpeedLimAxis and SpeedLimCheckPoint is too low.
ERR_STARTMOVE	The robot is in hold state when executing a StartMove, StartMoveRetry or SetLeadThrough instruction.
ERR_STORE_PROF	Error in the stored profile.
ERR_STRTOOLNG	The string is too long.
ERR_SYM_ACCESS	Symbol read/write access error.
ERR_SYMBOL_TYPE	The data object and the variable used in argument Value is of different types. If using ALIAS datatypes, you will also get this ERROR, eventhough the types might have the same base data type. Instructions GetDataVal, SetDataVal and SetAllDataVal.
ERR_SYNCMOVEOFF	Time-out from SyncMoveOff.
ERR_SYNCMOVEON	Time-out from SyncMoveOn.
ERR_SYNTAX	Syntax error in the loaded module.
ERR_TASKNAME	Task name not found in the system.
ERR_TP_DIBREAK	A read instruction from FlexPendant was interrupted by a digital input.
ERR_TP_DOBREAK	A read instruction from FlexPendant was interrupted by a digital output.
ERR_TP_MAXTIME	Time-out when executing a read instruction from FlexPendant.
ERR_TP_NO_CLIENT	No client to interact with when using a read instruction from FlexPendant.
ERR_TRUSTLEVEL	Not allowed to disable I/O device.
ERR_TXTNOEXIST	Wrong table or index in function TextGet.
ERR_UDPUC_COMM	Communication timeout for the UdpUc device.

Continues on next page

3 Data types

3.27 errnum - Error number

RobotWare Base

Continued

Name	Cause of error
ERR_UI_BUTTONS	The argument <code>Buttons</code> of type <code>buttondata</code> has a not allowed value.
ERR_UI_ICON	The argument <code>Icon</code> of type <code>icondata</code> has a not allowed value.
ERR_UI_INITVALUE	Initial value error in function <code>UINumEntry</code> .
ERR_UI_MAXMIN	Min value is greater then max value in function <code>UINumEntry</code> , <code>UIDnumEntry</code> , <code>UINumTune</code> or <code>UIDnumTune</code> .
ERR_UI_NOTINT	Value is not an integer when specified that an integer should be used when using <code>UINumEntry</code> or <code>UIDnumEntry</code> .
ERR_UISHOW_FATAL	Other error than <code>ERR_TP_NO_CLIENT</code> or <code>ERR_UISHOW_FULL</code> in instruction <code>UIShow</code> .
ERR_UISHOW_FULL	No space left on <code>FlexPendant</code> for another application when using instruction <code>UIShow</code> .
ERR_UNIT_PAR	Parameter <code>Mech_unit</code> in <code>TestSignDefine</code> is wrong.
ERR_UNKINO	Unknown interrupt number when executing instructions <code>IWatch</code> or <code>ISleep</code> .
ERR_UNKPROC	Incorrect reference to the load session in instruction <code>WaitLoad</code> .
ERR_UNLOAD	Unload error in instruction <code>UnLoad</code> or <code>WaitLoad</code> .
ERR_USE_PROF	Error in the used profile.
ERR_WAIT_MAXTIME	Time-out when executing a <code>WaitDI</code> , <code>WaitDO</code> , <code>WaitAI</code> , <code>WaitAO</code> , <code>WaitGI</code> , <code>WaitGO</code> , <code>WaitUntil</code> , <code>WaitSensor</code> or <code>WaitWObj</code> instruction.
ERR_WAITSYNCTASK	Time-out from <code>WaitSyncTask</code> .
ERR_WHLSEARCH	No search stop.
ERR_WOBJ_MOVING	The mechanical unit with work object is moving <code>CalcJointT</code> .

Characteristics

`errnum` is an alias data type for `num` and consequently inherits its characteristics.

Related information

For information about	See
Error recovery	<i>Technical reference manual - RAPID Overview</i>
Data types in general, alias data types	<i>Technical reference manual - RAPID Overview</i>

3.28 `errstr` - Error string

Usage

`errstr` is used to write text in error messages.

Basic examples

The following example illustrates the data type `errstr`:

Example 1

```
VAR errstr arg:= "This is an example";
```

```
ErrLog 4800, \W, ERRSTR_TASK, ERRSTR_CONTEXT, arg, ERRSTR_EMPTY,  
ERRSTR_EMPTY;
```

Predefined data

Name	Description
ERRSTR_EMPTY	Argument is empty, but exists in xml file. This is the case for 4800 to 4815 (see ErrLog - Write an error message on page 197). All these error messages have 5 arguments defined in the xml file.
ERRSTR_UNUSED	Argument is not used (see ErrRaise - Writes a warning and calls an error handler on page 201, example 2)
ERRSTR_TASK	Name of current task
ERRSTR_CONTEXT	Context

Characteristics

`errstr` is an alias data type for `string` and consequently inherits its characteristics.

Related information

For information about	See
Write an error message	ErrLog - Write an error message on page 197
Write a warning and call an error handler	ErrRaise - Writes a warning and calls an error handler on page 201
Data types in general, alias data types	<i>Technical reference manual - RAPID Overview, section Basic characteristics - Data Types</i>

3 Data types

3.29 errtype - Error type RobotWare Base

3.29 errtype - Error type

Usage

`errtype` (*error type*) is used to specify an error type.

Description

Data of the type `errtype` represents the type (state change, warning, error) of an error message.

Basic examples

The following example illustrates the data type `errtype`:

Example 1

```
VAR errdomain err_domain;  
VAR num err_number;  
VAR errtype err_type;  
VAR trapdata err_data;  
...  
TRAP trap_err  
  GetTrapData err_data;  
  ReadErrData err_data, err_domain, err_number, err_type;  
ENDTRAP
```

When an error is trapped to the trap routine `trap_err`, the error domain, the error number, and the error type are saved into appropriate variables.

Predefined data

The following predefined constants can be used to specify an error type.

Name	Error Type	Value
TYPE_ALL	Any type of error (state change, warning, error)	0
TYPE_STATE	State change (operational message)	1
TYPE_WARN	Warning (such as RAPID recoverable error)	2
TYPE_ERR	Error	3

Characteristics

`errtype` is an alias data type for `num` and consequently inherits its characteristics.

Related information

For information about	See
Ordering an interrupt on errors	IError - Orders an interrupt on errors on page 255
Error numbers	<i>Operating manual - Troubleshooting IRC5</i>
Alias data types	<i>Technical reference manual - RAPID Overview</i>
<i>Advanced RAPID</i>	<i>Product specification - Controller software IRC5</i>

3.30 event_type - Event routine type

Usage

`event_type` is used to represent the actual event routine type with a symbolic constant.

Description

With the function `EventType`, it is possible to check if the actual RAPID code is executed because of some specific system event or not.

Basic examples

The following example illustrates the data type `event_type`:

Example 1

```
VAR event_type my_type;
...
my_type := EventType( );
```

The event routine type that is executed will be stored in the variable `my_type`.

Predefined data

Following constants of type `event_type` are predefined:

RAPID constant	Value	Type of event executed
EVENT_NONE	0	No event is executed
EVENT_POWERON	1	POWER_ON event
EVENT_START	2	START event
EVENT_STOP	3	STOP event
EVENT_QSTOP	4	QSTOP event
EVENT_RESTART	5	RESTART event
EVENT_RESET	6	RESET event
EVENT_STEP	7	STEP event

Characteristics

`event_type` is an alias data type for `num` and consequently inherits its characteristics.

Related information

For information about	See
Event routines in general	<i>Technical reference manual - System parameters</i> , section <i>Controller - Event Routine</i>
Get event type	EventType - <i>Get current event type inside any event routine on page 1269</i>
Data types in general, alias data types	<i>Technical reference manual - RAPID Overview</i> , section <i>Basic characteristics - Data types</i>

3 Data types

3.31 exec_level - Execution level

RobotWare Base

3.31 exec_level - Execution level

Usage

`exec_level` is used to specify program execution level.

Description

With the function `ExecLevel`, it is possible to get the actual execution level for the RAPID code that currently is executed.

Predefined data

The following constants of type `exec_level` are predefined:

RAPID constant	Value	Execution level
<code>LEVEL_NORMAL</code>	0	Execute on base level
<code>LEVEL_TRAP</code>	1	Execute in trap routine
<code>LEVEL_SERVICE</code>	2	Execute in service routine ⁱ

ⁱ With `LEVEL_SERVICE` means event routine, service routine (including Call Routine) and interrupt routine from system input signal.

Characteristics

`exec_level` is an alias data type for `num` and consequently inherits its characteristics.

Related information

For information about	See
Get current execution level	ExecLevel - Get execution level on page 1272

3.32 extjoint - Position of external joints

Usage

`extjoint` is used to define the axis positions of additional axes, positioners, or workpiece manipulators.

Description

The robot can control up to six additional axes in addition to its six internal axes, i.e. a total of twelve axes. The six additional axes are logically denoted: a, b, c, d, e, f. Each such logical axis can be connected to a physical axis and, in this case, the connection is defined in the system parameters.

Data of the type `extjoint` is used to hold position values for each of the logical axes a - f.

For each logical axis connected to a physical axis, the position is defined as follows:

- For rotating axes– the position is defined as the rotation in degrees from the calibration position.
- For linear axes – the position is defined as the distance in mm from the calibration position.

If a logical axis is not connected to a physical one then the value 9E9 is used as a position value, indicating that the axis is not connected. At the time of execution, the position data of each axis is checked and it is checked whether or not the corresponding axis is connected. If the stored position value does not comply with the actual axis connection, the following applies:

- If the position is not defined in the position data (value is 9E9) then the value will be ignored if the axis is connected and not activated. But if the axis is activated, it will result in an error.
- If the position is defined in the position data, although the axis is not connected, then the value will be ignored.

No movement is performed but no error is generated for an axis with valid position data if the axis is not activated.

If an additional axis offset is used (instruction `EOffsOn` or `EOffsSet`) then the positions are specified in the `ExtOffs` coordinate system.

If an additional axis is running in independent mode and a new movement shall be performed by the robot and its additional axes, then the position data for the additional axes in independent mode must not be 9E9. The data must be an arbitrary value that is not used by the system.

Basic examples

The following example illustrates the data type `extjoint`:

Example 1

```
VAR extjoint axpos10 := [ 11, 12.3, 9E9, 9E9, 9E9, 9E9 ] ;
```

The position of an external positioner, `axpos10`, is defined as follows:

- The position of the external logical axis “a” is set to 11, expressed in degrees or mm (depending on the type of axis).

Continues on next page

3 Data types

3.32 extjoint - Position of external joints

RobotWare Base

Continued

- The position of the external logical axis“ b” is set to 12.3, expressed in degrees or mm (depending on the type of axis).
- Axes c to f are undefined.

Components

eax_a

external axis a

Data type: num

The position of the external logical axis“ a” expressed in degrees or mm (depending on the type of axis).

...

eax_f

external axis f

Data type: num

The position of the external logical axis“ f” expressed in degrees or mm (depending on the type of axis).

Structure

```
< dataobject of extjoint >
  < eax_a of num >
  < eax_b of num >
  < eax_c of num >
  < eax_d of num >
  < eax_e of num >
  < eax_f of num >
```

Related information

For information about	See
Position data	robtargt - Position data on page 1734 jointtargt - Joint position data on page 1679
ExtOffs coordinate system	EOffsOn - Activates an offset for additional axes on page 191

3.33 flypointdata - Data for flying start/end

Usage

`flypointdata` is used to define all data of flying start or flying end for a CAP process - it is part of `capdata` for both flying start and flying end.

Definitions

`flypointdata` defines data for both flying start and flying end:

- This functionality is only available for CAP.
- Flying start is triggered by the combination of *first instruction = TRUE* and zone point.
- Flying end is triggered by the combination of *last_instr = TRUE* and zone point.
- Weavestart will be ignored.
- If the starting point is a fine point, no flying start will be performed.
- If the end point is a fine point, no flying end will be performed.
- Motion delay will be ignored.
- Restart after an error will work in the same way as usual: there are no specific features for flying start, scrape start is available, if the application process was active, when the error occurred.
- If weaving is activated, the transition in the zone is made by ramping in the weaving pattern starting at the entrance to the zone until the full pattern is reached when the TCP leaves the zone.
- Supervision is active during START phase (with moving TCP), MAIN phase and END_MAIN phase (with moving TCP).
- Backing on the path will be limited to backing to position 4 (see the following figure).
- The user has to adapt distance and the approach and leaving angle to the application process: for example, for arc welding at the point where the arc shall be established (point 4 in the figure) has to be selected in such a way, that it is possible to ignite.
- The distance between position 4 and 6 must not be = 0.
- The `START process_dist` must be equal to or shorter than `START distance`.
- If program execution is stopped and the application process is active (between positions 3 and 6), CAP will behave as usual, that is, backing on path (only if pos. 4 had been passed), weave start, motion delay and movement start timeout are available.
- If program execution is stopped between positions 1 and 3 or between positions 7 and 10, the `CapX` instruction will behave like a `TrigX` instruction.
- The first CAP segment with flying start is recommended to be at least `START distance` long.

Continues on next page

3 Data types

3.33 flypointdata - Data for flying start/end

Continuous Application Platform (CAP)

Continued

- If the first segment is shorter than `START distance`, but longer than `START process_dist`, the positions 2 and 4 will be moved towards position 1.
- If the first segment is shorter than or equal `START process_dist`, positions 1 and 2 will coincide and position 4 will be at the end of the segment.
- The last CAP segment with flying end is recommended to be at least `END distance + END process_dist` long.
- If the last segment is shorter than `END distance + END process_dist`, but longer than `END process_dist`, the positions 7 and 9 will be moved towards position 10.
- If the last segment is shorter than or equal `END process_dist`, positions 8 and 10 will coincide and position 6 will be at the start of the segment.
- The `START` phase timeout specified in `capdata` will only be used at restart of the application process.
- If a process error occurs after the prefetch request from motion has arrived at the last CAP instruction (after position 9), that is, PGM is released from the CAP instruction and may continue with the next instruction, an error log message is sent, but the robot movement continues.

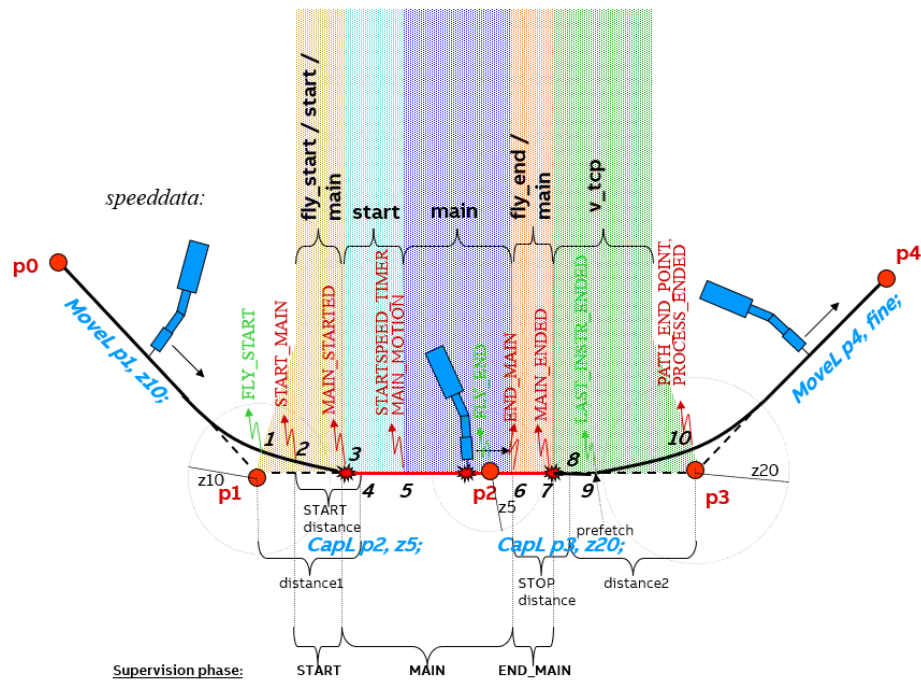

xx120000180

Components

from_start

Data type: bool

Not used.

process_dist

Data type: num

Continues on next page

3.33 flypointdata - Data for flying start/end Continuous Application Platform (CAP) Continued

The distance (in mm) within which the process is started (for *flying start*) or ended (for *flying end*).

distance

Data type: num

Sets the start/end of the supervision of the CAP process as a distance (in mm) from the start/end point.

Structure

```
< databases of flypointdata >  
  < from_start of bool >  
  < process_dist of num >  
  < distance of num >
```

Related information

	Described in:
capdata data type	capdata - CAP data on page 1614
<i>Continuous Application Platform</i>	<i>Application manual - Continuous Application Platform</i>

3 Data types

3.34 handler_type - Type of execution handler

RobotWare Base

3.34 handler_type - Type of execution handler

Usage

`handler_type` is used to specify type of execution handler in RAPID program routine.

Description

With the function `ExecHandler`, it is possible to check if the actual RAPID code is executed in some execution handler in RAPID program routine.

Basic examples

The following example illustrates the data type `handler_type`:

Example 1

```
VAR handler_type my_type;  
...  
my_type := ExecHandler( );
```

The type of execution handler that the code is executed in, will be stored in the variable `my_type`.

Predefined data

Following constants of type `handler_type` are predefined:

RAPID constant	Value	Type of execution handler
HANDLER_NONE	0	Not executed in any handler
HANDLER_BWD	1	Executed in BACKWARD handler
HANDLER_ERR	2	Executed in ERROR handler
HANDLER_UNDO	3	Executed in UNDO handler

Characteristics

`handler_type` is an alias data type for `num` and consequently inherits its characteristics.

Related information

For information about	See
Get type of execution handler	ExecHandler - Get type of execution handler on page 1271

3.35 icondata - Icon display data

Usage

`icondata` is used for representing standard icons on the User Device such as the FlexPendant.

Description

An `icondata` enumeration constant may be passed to the `Icon` argument in the instructions `UIMsgBox`, `UIMsgWrite`, `WaitAI`, `WaitAO`, `WaitDI`, `WaitDO`, `WaitGI`, `WaitGO` and `WaitUntil` and functions `UIMessageBox`, `UINumEntry`, `UIDnumEntry`, `UINumTune`, `UIDnumTune`, `UIAlphaEntry` and `UIListView`.

Basic examples

The following example illustrates the data type `icondata`:

Example 1

```
VAR btnres answer;

UIMsgBox "More ?" \Buttons:=btnYesNo \Icon:=iconInfo \Result:=
  answer;
IF answer= resYes THEN
  ...
ELSEIF answer =ResNo THEN
  ...
ENDIF
```

The standard button enumeration constant `iconInfo` will give an information icon at the head of the message box on the user interface.

Predefined data

The following constants of the data type `icondata` are predefined in the system:

Value	Constant	Icon
0	<code>iconNone</code>	No icon
1	<code>iconInfo</code>	Information icon
2	<code>iconWarning</code>	Warning icon
3	<code>iconError</code>	Error icon
4	<code>iconQuestion</code>	Question icon

Characteristics

`icondata` is an alias data type for `num` and consequently inherits its characteristics.

Related information

For information about	See
User Interaction Message Box	UIMsgBox - User Message Dialog Box type basic on page 992

Continues on next page

3 Data types

3.35 icondata - Icon display data

RobotWare Base

Continued

For information about	See
User Interaction Message Box	UIMessageBox - User Message Box type advanced on page 1567
User Interaction Number Entry	UINumEntry - User Number Entry on page 1576
User Interaction Number Tune	UINumTune - User Number Tune on page 1583
User Interaction Alpha Entry	UIAlphaEntry - User Alpha Entry on page 1536
User Interaction List View	UIListView - User List View on page 1558
Data types in general, alias data types	<i>Technical reference manual - RAPID Overview, section Basic Characteristics - Data Types</i>

3.36 identno - Identity for move instructions

Usage

`identno` (*Identity Number*) is used to control synchronizing of two or more coordinated synchronized movements with each other.

The data type `identno` can only be used in a *MultiMove* system with option *Coordinated Robots* and only in program tasks defined as Motion Task.

Description

Move instructions in a *MultiMove* system must be programmed with parameter `\ID` of data type `identno`, if coordinated synchronized movement, and `\ID` is not allowed in any other cases.

The specified `\ID` number must be the same in all cooperating program tasks. The id number gives a guarantee that the movements are not mixed up at runtime.

In coordinated synchronized mode, there must be the same amount of executed move instructions in all program tasks. The optional parameter `\ID` of data type `identno` will be used to check that associated move instructions are run in parallel before the start of the movements. The `\ID` number must be the same in the move instructions that are run in parallel.

The user does not have to declare any variable of type `identno`, but can use a number directly in the instructions (see *Basic examples*).

Basic examples

The following example illustrates the data type `identno`:

Example 1

```

PERS tasks task_list{2} := [{"T_ROB1"}, {"T_ROB2"}];
VAR syncident sync1;
VAR syncident sync2;

PROC procl()
  ...
  SyncMoveOn sync1, task_list;
  MoveL *\ID:=10,v100,z50,mytool;
  MoveL *\ID:=20,v100,fine,mytool;
  SyncMoveOff sync2;
  ...
ENDPROC

```

Characteristics

`identno` is an alias data type for `num` and thus inherits its properties.

Related information

For information about	See
Alias data types	<i>Technical reference manual - RAPID Overview</i> , section <i>Basic Characteristics - Data types</i>

Continues on next page

3 Data types

3.36 identno - Identity for move instructions

MultiMove - Coordinated Robots

Continued

For information about	See
Start coordinated synchronized movements	SyncMoveOn - Start coordinated synchronized movements on page 842
End coordinated synchronized movements	SyncMoveOff - End coordinated synchronized movements on page 836

3.37 intnum - Interrupt identity

Usage

`intnum` (*interrupt numeric*) is used to identify an interrupt.

Description

When a variable of type `intnum` is connected to a trap routine, it is given a specific value identifying the interrupt. This variable is then used in all dealings with the interrupt, such as when ordering or disabling an interrupt.

More than one interrupt identity can be connected to the same trap routine. The system variable `INTNO` can thus be used in a trap routine to determine the type of interrupt that occurs.

A variable of the type `intnum` must always be declared global in the module.

Basic examples

The following examples illustrate the data type `intnum`:

Example 1

```

VAR intnum feeder_error;
...
PROC main()
  CONNECT feeder_error WITH correct_feeder;
  ISignalDI di1, 1, feeder_error;

```

An interrupt is generated when the input `di1` is set to 1. When this happens, a call is made to the `correct_feeder` trap routine.

Example 2

```

VAR intnum feeder1_error;
VAR intnum feeder2_error;
...
PROC init_interrupt()
...
  CONNECT feeder1_error WITH correct_feeder;
  ISignalDI di1, 1, feeder1_error;
  CONNECT feeder2_error WITH correct_feeder;
  ISignalDI di2, 1, feeder2_error;
...
ENDPROC
...
TRAP correct_feeder
  IF INTNO=feeder1_error THEN
  ...
  ELSE
  ...
  ENDIF
...
ENDTRAP

```

Continues on next page

3 Data types

3.37 intnum - Interrupt identity

RobotWare Base

Continued

An interrupt is generated when either of the inputs `di1` or `di2` is set to 1. A call is then made to the `correct_feeder` trap routine. The system variable `INTNO` is used in the trap routine to find out which type of interrupt has occurred.

Limitations

The maximum number of active variables of type `intnum` at any one time (between `CONNECT` and `IDelete`) is limited to 100. The maximum number of interrupts, in the queue for execution of trap routine at any one time, is limited to 30.

Characteristics

`Intnum` is an alias data type for `num` and thus inherits its properties.

Related information

For information about	See
Summary of interrupts	<i>Technical reference manual - RAPID Overview, section RAPID Summary - Interrupts</i>
Alias data types	<i>Technical reference manual - RAPID Overview, section Basic Characteristics - Data Types</i>
Connecting interrupts	CONNECT - Connects an interrupt to a trap routine on page 160

3.38 iodev - I/O device

Usage

`iodev` (*I/O device*) is used for I/O devices and files.

Description

Data of the type `iodev` contains a reference to a file or I/O device. It can be linked to the physical unit by means of the instruction `Open` and then used for reading and writing.

Basic examples

The following example illustrates the data type `iodev`:

Example 1

```
VAR iodev file;
...
Open "HOME:/LOGDIR/INFILE.DOC", file\Read;
input := ReadNum(file);
```

The file `INFILE.DOC` is opened for reading. When reading from the file, `file` is used as a reference instead of the file name.

Characteristics

`iodev` is a non-value data type.

Related information

For information about	See
Communication via I/O devices	<i>Technical reference manual - RAPID Overview, section RAPID Summary - Communication</i>
Configuration of I/O devices	<i>Technical reference manual - System parameters</i>
Characteristics of non-value data types	<i>Technical reference manual - RAPID Overview, section Basic Characteristics - Data Types</i>
File and I/O device handling	<i>Application manual - Controller software IRC5</i>

3 Data types

3.39 iounit_state - State of I/O device RobotWare Base

3.39 iounit_state - State of I/O device

Usage

`iounit_state` is used to mirror which state an I/O device is currently in.

Description

An `iounit_state` constant is intended to be used when checking the return value from the function `IOUnitState`.

Basic examples

The following example illustrates the data type `iounit_state`:

Example 1

```
IF (IOUnitState ("UNIT1" \Phys) = IOUNIT_PHYS_STATE_RUNNING) THEN
  ! Possible to access some signal on the I/O unit
ELSE
  ! Read/Write some signal on the I/O unit result in error
ENDIF
```

Test is done if the I/O device `UNIT1` is up and running.

Predefined data

The predefined symbolic constants of the data type `iounit_state` is found in function `IOUnitState`.

Characteristics

`iounit_state` is an alias data type for `num` and consequently inherits its characteristics.

Related information

For information about	See
Get current state of I/O device	IOUnitState - Get current state of I/O device on page 1334
Input/Output instructions	<i>Technical reference manual - RAPID Overview, section RAPID Summary - Input and Output Signals</i>
Input/Output functionality in general	<i>Technical reference manual - RAPID Overview, section Motion and I/O Principles - I/O Principles</i>
Configuration of I/O	<i>Technical reference manual - System parameters</i>

3.40 jointtarget - Joint position data

Usage

`jointtarget` is used to define the position that the robot and the external axes will move to with the instruction `MoveAbsJ`.

Description

`jointtarget` defines each individual axis position, for both the robot and the external axes.

Basic examples

The following example illustrates the data type `jointtarget`:

Example 1

```
CONST jointtarget calib_pos := [ [ 0, 0, 0, 0, 0, 0 ], [ 0, 9E9,
                                9E9, 9E9, 9E9, 9E9 ] ];
```

The normal calibration position for IRB2400 is defined in `calib_pos` by the data type `jointtarget`. The normal calibration position 0 (degrees or mm) is also defined for the external logical axis `a`. The external axes `b` to `f` are undefined.

Components

`robax`

robot axes

Data type: `robjoint`

Axis positions of the robot axes in degrees.

Axis position is defined as the rotation in degrees for the respective axis (arm) in a positive or negative direction from the axis calibration position.

`extax`

external axes

Data type: `extjoint`

The position of the external axes.

The position is defined as follows for each individual axis (`eax_a`, `eax_b` . . . `eax_f`):

- For rotating axes, the position is defined as the rotation in degrees from the calibration position.
- For linear axes, the position is defined as the distance in mm from the calibration position.

External axes `eax_a` . . . are logical axes. How the logical axis number and the physical axis number are related to each other is defined in the system parameters.

Continues on next page

3 Data types

3.40 jointtarget - Joint position data

RobotWare Base

Continued

The value 9E9 is defined for axes which are not connected. If the axes defined in the position data differ from the axes that are actually connected on program execution, the following applies:

- If the position is not defined in the position data (value 9E9) the value will be ignored, if the axis is connected and not activated. But if the axis is activated it will result in error.
- If the position is defined in the position data, although the axis is not connected, the value is ignored.

No movement is performed but no error is generated for an axis with valid position data, if the axis isn't activated.

If some external axis is running in independent mode and some new movement shall be performed by the robot and its external axes then the position data for the external axis in independent mode must not be 9E9 but some arbitrary value (not used but the system).

Structure

```
< dataobject of jointtarget >
  < robax of rojoint >
    < rax_1 of num >
    < rax_2 of num >
    < rax_3 of num >
    < rax_4 of num >
    < rax_5 of num >
    < rax_6 of num >
  < extax of extjoint >
    < eax_a of num >
    < eax_b of num >
    < eax_c of num >
    < eax_d of num >
    < eax_e of num >
    < eax_f of num >
```

Related information

For information about	See
Move to joint position	MoveAbsJ - Moves the robot to an absolute joint position on page 395 MoveExtJ - Move one or several mechanical units without TCP on page 430
Positioning instructions	<i>Technical reference manual - RAPID Overview, section RAPID summary - Motion</i>
Configuration of external axes	<i>Application manual - Additional axes and standalone controller</i>

3.41 listitem - List item data structure

Usage

`listitem` is used to define menu lines that include text with optional small icons on the User Device such as the FlexPendant.

Description

Data of the type `listitem` allows the user to define menu lines for the function `UIListView`.

Basic example

The following example illustrates the data type `listitem` :

Example 1

```
CONST listitem list {3}:=[[stEmpty, "Item1"], [stEmpty, "Item2"],
[stEmpty, "Item3"]];
```

A menu list with Item1....Item3 to use in function `UIListView`.

Components

The data type has the following components:

image

Data type: `string`

The path including file name for the icon image to display (not implemented in this software release).

Use empty string `" "` or `stEmpty` if no icon to display.

text

Data type: `string`

The text for the menu line to display.

Structure

```
<dataobject of listitem>
  <image of string>
  <text of string>
```

Related information

For information about	See
User Interaction ListView	UIListView - User List View on page 1558

3 Data types

3.42 loaddata - Load data

RobotWare Base

3.42 loaddata - Load data

Usage

`loaddata` is used to describe loads attached to the mechanical interface of the robot (the robot's mounting flange).

Load data usually defines the payload or grip load (set up by the instruction `GripLoad` or `MechUnitLoad` for positioners) of the robot, that is, the load held in the robot gripper. `loaddata` is also used as part of `tooldata` to describe the tool load.

Description

Specified loads are used to set up a dynamic model of the robot so that the robot movements is controlled in the best possible way.



WARNING

It is important to always define the actual tool load and, when used, the payload of the robot (for example, a gripped part). Incorrect definitions of load data can result in overloading of the robot mechanical structure. There is also a risk that the speed in manual reduced speed mode can be exceeded.

When incorrect load data is specified, it can often lead to the following consequences:

- The robot may not use its maximum capacity.
- Impaired path accuracy including a risk of overshooting.
- Risk of overloading the mechanical structure.

The controller continuously monitors the load and writes an event log if the load is higher than expected. This event log is saved and logged in the controller memory.

Basic examples

The following examples illustrate the data type `loaddata`:

Example 1

```
PERS loaddata piece1 := [ 5, [50, 0, 50], [1, 0, 0, 0], 0, 0, 0];
```

The payload moved by a robot held tool in the figure [Robot held tool on page 1684](#) is described using the following values:

- Weight 5 kg.
- The center of gravity is $x = 50$, $y = 0$ and $z = 50$ mm in the tool coordinate system
- The payload is a point mass

Example 2

```
Set gripper;  
WaitTime 0.3;  
GripLoad piece1;
```

Continues on next page

Connection of the payload, `piece1`, specified at the same time as the robot grips the load.

Example 3

```
Reset gripper;
WaitTime 0.3;
GripLoad load0;
```

Disconnection of the payload, specified at the same time as the robot releases a payload.

Example 4

```
PERS loaddata piece2 := [ 5, [50, 50, 50], [0, 0, 1, 0], 0, 0, 0];
PERS wobjdata wobj2 :=[ TRUE, TRUE, "", [ [0, 0, 0], [1, 0, 0, 0]
], [ [50, -50, 200], [0.5, 0, -0.866, 0] ] ];
```

The payload moved according to the stationary tool in the figure [Stationary tool on page 1685](#) is described using the following values for the `loaddata`:

- Weight 5 kg
- The center of gravity is $x = 50$, $y = 50$ and $z = 50$ mm in the object coordinate system for work object `wobj2`
- The payload coordinate system/axes of moments are rotated 180° around "Y" according to the object coordinate system
- The payload is a point mass

The following values are used for the `wobjdata`:

- The robot is holding the work object
- The fixed user coordinate system is used, that is, the user coordinate system is the same as wrist coordinate system
- The object coordinate system is rotated -120° around Y and the coordinates of its origin are $x = 50$, $y = -50$ and $z = 200$ mm in the user coordinate system

Predefined data

The load `load0` defines a payload, with the mass equal to 0 kg, that is, no load at all. This load is used as the argument in the instructions `GripLoad` and `MechUnitLoad` to disconnect the payload.

The load `load0` can always be accessed from the program, but cannot be changed (it is stored in the system module `BASE`).

```
PERS loaddata load0 := [ 0.001, [0, 0, 0.001], [1, 0, 0, 0], 0, 0
, 0 ];
```

Components



Note

In this description, `loaddata` is only described as used for payload. As used for tool load, see [tooldata - Tool data on page 1776](#).

mass

Data type: num

Continues on next page

3 Data types

3.42 loaddata - Load data

RobotWare Base

Continued

The mass (weight) of the load in kg.

cog

center of gravity

Data type: pos

The center of gravity of the payload expressed in mm in the tool coordinate system if the robot is holding the tool. If a stationary tool is used then the center of gravity for the payload held by the gripper is expressed in the object frame of the work object coordinate system moved by the robot.

aom

axes of moment

Data type: orient

The orientation of the axes of moment. These are the principal axes of the payload moment of inertia with origin in cog. If the robot is holding the tool, the axes of moment are expressed in the tool coordinate system.

The figure shows the center of gravity and inertial axes of the payload.

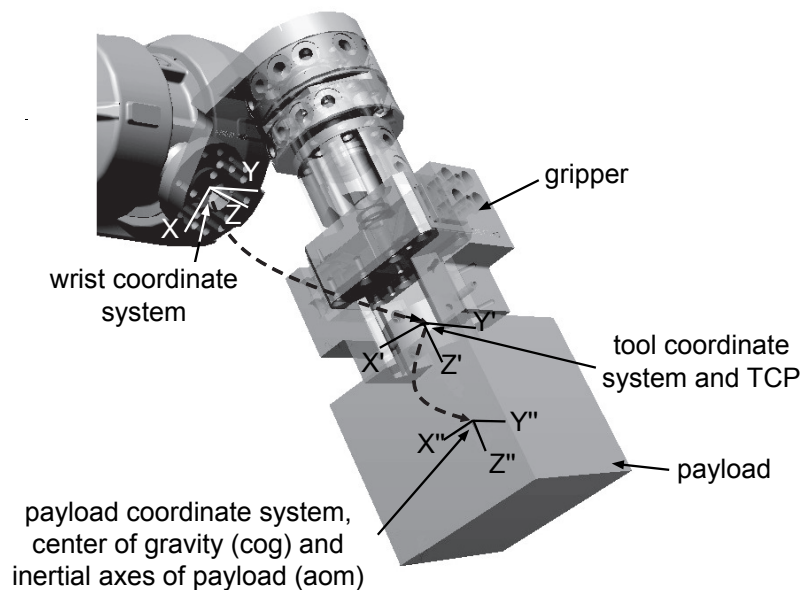

xx1100000515

Figure 3.1: Robot held tool



Note

If *PayloadsInWristCoords* is used, the axes of moment for the payload for the robot held tool are expressed in the wrist coordinate system. For more information see *Technical reference manual - System parameters*, section *PayloadsInWristCoords*.

Continues on next page

The axes of moment are expressed in the object coordinate system if a stationary tool is used.

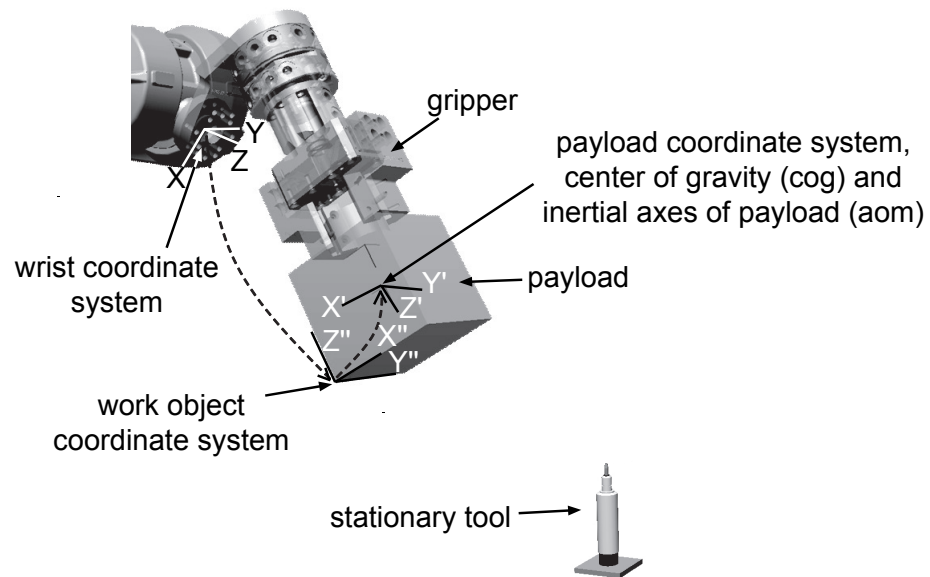

xx110000516

Figure 3.2: Stationary tool



Note

If *PayloadsInWristCoords* or *StationaryPayloadMode* is used, the axes of moment for the payload for the stationary tool are expressed in the wrist coordinate system. See *Technical reference manual - System parameters*, sections *PayloadsInWristCoords* and *StationaryPayloadMode*.

ix

inertia x

Data type: num

The moment of inertia of the load around the x-axis of moment expressed in kgm^2 . Correct definition of the moments of inertia will allow optimal utilization of the path planner and axes control. This may be of special importance when handling large sheets of metal, and so on. All moments of inertia i_x , i_y , and i_z equal to 0 kgm^2 imply a point mass.

Continues on next page

3 Data types

3.42 loaddata - Load data

RobotWare Base

Continued

Normally, the moments of inertia must only be defined when the distance from the mounting flange to the center of gravity is less than the maximal dimension of the load (see the following figure).

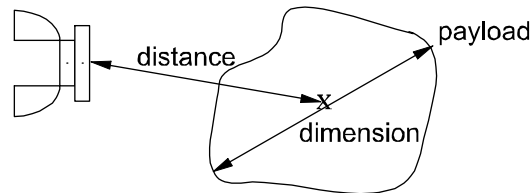

xx0500002372

iy

inertia y

Data type: num

The moment of inertia of the load around the y-axis, expressed in kgm^2 .

For more information, see *ix*.

iz

inertia z

Data type: num

The moment of inertia of the load around the z-axis, expressed in kgm^2 .

For more information, see *ix*.

Limitations

The payload should only be defined as a persistent variable (*PERS*) and not within a routine. Current values are then saved when saving the program and are retrieved on loading.

Arguments of the type *loaddata* in the *GripLoad* and *MechUnitLoad* instruction should only be an entire persistent (not array element or record component).

Structure

```
<dataobject of loaddata>
  <mass of num>
  <cog of pos>
    <x of num>
    <y of num>
    <z of num>
  <aom of orient>
    <q1 of num>
    <q2 of num>
    <q3 of num>
    <q4 of num>
  <ix of num>
  <iy of num>
```

Continues on next page

<iz of num>

Related information

For information about	See
Coordinate systems	<i>Technical reference manual - RAPID Overview</i>
Definition of tool loads	tooldata - Tool data on page 1776
Define payload for robots	GripLoad - Defines the payload for a robot on page 243
Define payload for mechanical units	MechUnitLoad - Defines a payload for a mechanical unit on page 385
Load identification of tool load, payload or arm load	<i>Operating manual - IRC5 with FlexPendant</i>
Definition of arm loads	<i>Technical reference manual - System parameters, see How to define arm loads</i>
Definition of work object data	wobjdata - Work object data on page 1803
PayloadsInWristCoords StationaryPayloadMode	<i>Technical reference manual - System parameters, topic Controller, type General Rapid</i>

3 Data types

3.43 loadidnum - Type of load identification

RobotWare Base

3.43 loadidnum - Type of load identification

Usage

loadidnum is used to represent an integer with a symbolic constant.

Description

A loadidnum constant is intended to be used for load identification of tool or payload as arguments in instruction LoadId. See the following example.

Basic examples

The following example illustrates the data type loadidnum:

Example 1

```
! Load modules into the system
Load \Dynamic, "RELEASE:/system/mockit.sys";
Load \Dynamic, "RELEASE:/system/mockit1.sys";
%"LoadId"% TOOL_LOAD_ID, MASS_WITH_AX3, gun1;
```

Load identification of tool gun1 with identification of mass with movements of robot axis 3 with use of predefined constant MASS_WITH_AX3 of data type loadidnum.

Predefined data

The following symbolic constants of the data type loadidnum are predefined and is used as arguments in instruction LoadId.

Value	Symbolic constant	Comment
1	MASS_KNOWN	Known mass in tool or payload respectively.
2	MASS_WITH_AX3	Unknown mass in tool or payload. Identification of mass will be done with movements of axis 3

Characteristics

loadidnum is an alias data type for num and consequently inherits its characteristics.

Related information

For information about	See
Predefined program Load Identify	<i>Operating manual - IRC5 with FlexPendant, section Programming and testing - Service routines- LoadIdentify, load identification and service routines</i>
Valid robot type	ParIdRobValid - Valid robot type for parameter identification on page 1392
Valid robot position	ParIdPosValid - Valid robot position for parameter identification on page 1389
Load identification with complete example	LoadId - Load identification of tool or payload on page 347

3.44 loadsession - Program load session

Usage

`loadsession` is used to define different load sessions of RAPID program modules.

Description

Data of the type `loadsession` is used in the instructions `StartLoad` and `WaitLoad` to identify the load session. `loadsession` only contains a reference to the load session.

Characteristics

`loadsession` is a non-value data type and cannot be used in value-oriented operations.

Related information

For information about	See
Loading program modules during execution	StartLoad - Load a program module during execution on page 787 WaitLoad - Connect the loaded module to the task on page 1061
Characteristics of non-value data types	<i>Technical reference manual - RAPID Overview, section Basic characteristics - Data types</i>

3 Data types

3.45 mecunit - Mechanical unit *RobotWare Base*

3.45 mecunit - Mechanical unit

Usage

`mecunit` is used to define the different mechanical units which can be controlled and accessed from the program.

The names of the mechanical units are defined in the system parameters and, consequently, must not be defined in the program.

Description

Data of the type `mecunit` only contains a reference to the mechanical unit.

Basic examples

The following example illustrates the data type `mecunit`:

Example 1

```
IF TaskRunRob() THEN
  IndReset ROB_ID, 6;
ENDIF
```

If actual program task controls a robot, reset axis 6 for the robot.

Predefined data

All the mechanical units defined in the system parameters are predefined in every program task. But only the mechanical units that are controlled by the actual program task (defined in system parameters *Controller/Task/Use Mechanical Unit Group*) is used to do any control operations.

Besides that, the predefined variable `ROB_ID` of data type `mecunit` is available in every program task. If an actual program task controls a robot then the alias variable `ROB_ID` contains a reference to one of robot `ROB_1` to `ROB_6`, which can be used to do control operation on the robot. The variable `ROB_ID` is invalid if the actual program task does not control any robot.

Limitations

Data of the type `mecunit` must not be defined in the program. However, if it is then an error message will be displayed as soon as an instruction or function that refers to this `mecunit` is executed. The data type can, on the other hand, be used as a parameter when declaring a routine.

Characteristics

`mecunit` is a *non-value* data type. This means that data of this type does not permit value-oriented operations.

Related information

For information about	See
Check if task run some robot	TaskRunRob - Check if task controls some robot on page 1507

Continues on next page

For information about	See
Check if task run some mechanical unit	TaskRunMec - Check if task controls any mechanical unit on page 1506
Get the name of mechanical units in the system	GetNextMechUnit - Get name and data for mechanical units on page 1295
Activating/Deactivating mechanical units	ActUnit - Activates a mechanical unit on page 30 DeactUnit - Deactivates a mechanical unit on page 184
Configuration of mechanical units	<i>Technical reference manual - System parameters</i>
Characteristics of non-value data types	<i>Technical reference manual - RAPID Overview, section Basic characteristics - Data types</i>

3 Data types

3.46 motsetdata - Motion settings data *RobotWare Base*

3.46 motsetdata - Motion settings data

Usage

`motsetdata` is used to define a number of motion settings that affect all movement instructions in the program:

- Max. velocity and velocity override
- Acceleration data
- Behavior around singular points
- Management of different robot configurations
- Override of path resolution
- Motion supervision
- Limitation of acceleration/deceleration
- Tool reorientation during circle path
- Activation and deactivation of event buffer

This data type does not normally have to be used since these settings can only be set using the instructions `VelSet`, `AccSet`, `SingArea`, `ConfJ`, `ConfL`, `PathResol`, `MotionSup`, `PathAccLim`, `CirPathMode`, `WorldAccLim`, `ActEventBuffer`, `DeactEventBuffer` and `CornerPathWarning`.

The current values of these motion settings is accessed using the system variable `C_MOTSET`.

Description

The current motion settings (stored in the system variable `C_MOTSET`) affect all movements.

Basic examples

The following example illustrates the data type `motsetdata`:

Example 1

```
IF C_MOTSET.vel.override > 50 THEN
  ...
ELSE
  ...
ENDIF
```

Different parts of the program are executed depending on the current velocity override.

Predefined data

`C_MOTSET` describes the current motion settings of the robot and can always be accessed from the program. On the other hand, `C_MOTSET` can only be changed using a number of instructions, not by assignment.

The following default values for motion parameters are set

- when using the restart mode **Reset RAPID**
- when loading a new program or a new module
- when starting program execution from the beginning

Continues on next page

- when moving the program pointer to `main`
- when moving the program pointer to a routine
- when moving the program pointer in such a way that the execution order is lost.

```
VAR motsetdata C_MOTSET := [
  [ 100, 5000 ],-> veldata
  [ 100, 100, 100 ],-> accdata
  [ FALSE, FALSE, FALSE, TRUE ],-> singdata
  [ TRUE, TRUE, 30, 45, 90 ]-> confsupdata
  100,-> path resolution
  TRUE,-> motionsup
  100,-> tunevalue
  TRUE,-> backoffaftercoll
  FALSE,-> acclim
  -1,-> accmax
  FALSE,-> decellim
  -1,-> decelmax
  0,-> cirpathreori
  FALSE,-> worldacclim
  -1,-> worldaccmax
  TRUE,-> evtbufferact
  FALSE];-> corner_path_warn_suppress
```

**Note**

The maximum TCP speed for the used robot type can be changed in the *Motion* configuration system parameters, type *Motion Planner* and attribute *Linear Max Speed*. The RAPID function `MaxRobSpeed` returns the same value.

Components**Note**

Some components are prepared for in the structure but are currently not implemented in the corresponding instructions.

`vel.oride`

Data type: `veldata/num`

Velocity override as a percentage of the programmed value.

`vel.max`

Data type: `veldata/num`

Maximum velocity in mm/s.

`acc.acc`

Data type: `accdata/num`

Acceleration and deceleration as a percentage of the normal values.

Continues on next page

3 Data types

3.46 motsetdata - Motion settings data

RobotWare Base

Continued

`acc.ramp`

Data type: `accddata/num`

The rate by which acceleration and deceleration increases as a percentage of the normal values.

`acc.finepramp`

Data type: `accddata/num`

The rate at which deceleration decreases as a percentage of the normal values when the robot decelerates towards a finepoint.

`sing.wrist`

Data type: `singdata/bool`

The orientation of the tool is allowed to deviate somewhat in order to prevent wrist singularity.

`sing.lockaxis4`

Data type: `singdata/bool`

Lock axis 4 on a six-axis robot to 0 or ± 180 degrees to avoid singularity problems when axis 5 is close to 0.

`sing.arm`

Data type: `singdata/bool`

The orientation of the tool is allowed to deviate somewhat in order to prevent arm singularity (not implemented).

`sing.base`

Data type: `singdata/bool`

The orientation of the tool is not allowed to deviate.

`conf.jsup`

Data type: `confsupdata/bool`

During joint movement the robot will reach the programmed robot configuration.

`conf.lsup`

Data type: `confsupdata/bool`

Supervision of joint configuration is active during linear and circular movement.

`conf.ax1`

Data type: `confsupdata/num`

Maximum permitted deviation in degrees for axis 1 (not implemented).

`conf.ax4`

Data type: `confsupdata/num`

Maximum permitted deviation in degrees for axis 4 (not implemented).

`conf.ax6`

Data type: `confsupdata/num`

Maximum permitted deviation in degrees for axis 6 (not implemented).

Continues on next page

pathresol

Data type: num

Current override in percentage of the configured path resolution.

motionsup

Data type: bool

Mirror RAPID status (TRUE = On and FALSE = Off) of motion supervision function.

tunevalue

Data type: num

Current RAPID override as a percentage of the configured tunevalue for the motion supervision function.

backoffaftercoll

Data type: bool

Mirror RAPID status of back up to remove any residual forces at motion collision:

TRUE = Back up to remove residual forces at motion collision

FALSE = No back off at motion collision

acclim

Data type: bool

Limitation of tool acceleration along the path. (TRUE = limitation and FALSE = no limitation).

accmax

Data type: num

TCP acceleration limitation in m/s^2 . If acclim is FALSE, the value is always set to -1.

decellim

Data type: bool

Limitation of tool deceleration along the path. (TRUE = limitation and FALSE = no limitation).

decelmax

Data type: num

TCP deceleration limitation in m/s^2 . If decellim is FALSE, the value is always set to -1.

cirpathreori

Data type: num

Tool reorientation during circle path:

0 = Standard method with interpolation in path frame

1 = Modified method with interpolation in object frame

2 = Modified method with programmed tool orientation in CirPoint

Continues on next page

3 Data types

3.46 motsetdata - Motion settings data

RobotWare Base

Continued

worldacclim

Data type: bool

Limitation of acceleration in world coordinate system. (TRUE = limitation and FALSE = no limitation).

worldaccmax

Data type: num

Limitation of acceleration in world coordinate system in m/s^2 . If worldacclim is FALSE, the value is always set to -1.

evtbufferact

Data type: bool

Event buffer active or not active. (TRUE = event buffer active and FALSE = event buffer not active).

corner_path_warn_suppress

Data type: bool

Corner path warning will be reported or not. TRUE = corner path warning is suppressed, FALSE = corner path warning is not suppressed.

Limitations

One and only one of the components `sing.wrist`, `sing.arm` or `sing.base` may have a value equal to TRUE.

Structure

<dataobject of motsetdata>	
<vel of veldata>	Affected by instruction VelSet
<oride of num>	
<max of num>	
<acc of accdata>	Affected by instruction AccSet
<acc of num>	
<ramp of num>	
<finepramp of num>	
<sing of singdata>	Affected by instruction SingArea
<wrist of bool>	
<lockaxis4 of bool>	
<arm of bool>	
<base of bool>	
<conf of confsupdata>	Affected by instructions ConfJ and ConfL
<jsup of bool>	
<lsup of bool>	
<ax1 of num>	
<ax4 of num>	
<ax6 of num>	
<pathresol of num>	Affected by instruction PathResol
<motionsup of bool>	Affected by instruction MotionSup

Continues on next page

<tunevalue of num>	Affected by instruction <code>MotionSup</code>
<backoffaftercoll of bool>	Affected by instruction <code>MotionSup</code>
<acclim of bool>	Affected by instruction <code>PathAccLim</code>
<accmax of num>	Affected by instruction <code>PathAccLim</code>
<decellim of bool>	Affected by instruction <code>PathAccLim</code>
<decelmax of num>	Affected by instruction <code>PathAccLim</code>
<cirpathreori of num>	Affected by instruction <code>CirPathMode</code>
<worldacclim of bool>	Affected by instruction <code>WorldAccLim</code>
<worldaccmax of num>	Affected by instruction <code>WorldAccLim</code>
<evtbufferact of bool>	Affected by instructions <code>ActEventBuffer</code> and <code>DeactEventBuffer</code>
<corner_path_warn_suppress of bool>	Affected by instruction <code>CornerPathWarning</code>

Related information

For information about	See
Reduction of acceleration	AccSet - Reduces the acceleration on page 25
Activation of event buffer	ActEventBuffer - Activation of event buffer on page 28
Tool reorientation during circle path	CirPathMode - Tool reorientation during circle path on page 132
Robot configuration during joint movement	ConfJ - Controls the configuration during joint movement on page 155
Robot configuration during linear movement	ConfL - Monitors the configuration during linear movement on page 157
Suppressing corner path warnings	CornerPathWarning - Show or hide corner path warnings on page 171
Deactivation of event buffer	DeactEventBuffer - Deactivation of event buffer on page 182
Deactivate or activate the motion supervision function	MotionSup - Deactivates/Activates motion supervision on page 392
Limitation of acceleration along the path	PathAccLim - Reduce TCP acceleration along the path on page 512
Override the configured geometric path sample time	PathResol - Override path resolution on page 537
Define interpolation around singular points	SingArea - Defines interpolation around singular points on page 729
Defining maximum velocity	VelSet - Changes the programmed velocity on page 1017
Control acceleration in world coordinate system	WorldAccLim - Control acceleration in world coordinate system on page 1093
Instructions for setting motion parameters	<i>Technical reference manual - RAPID Overview, section RAPID summary - Motion settings</i>

3 Data types

3.47 num - Numeric values

RobotWare Base

3.47 num - Numeric values

Usage

`num` is used for numeric values; e.g. counters.

Description

The value of the `num` data type may be

- an integer; e.g. -5,
- a decimal number; e.g. 3.45.

It may also be written exponentially; e.g. $2E3$ ($= 2 \cdot 10^3 = 2000$), $2.5E-2$ ($= 0.025$).

Integers between -8388607 and +8388608 are always stored as exact integers.

Decimal numbers are only approximate numbers and therefore should not be used in *is equal to* or *is not equal to* comparisons. In the case of divisions and operations using decimal numbers, the result will also be a decimal number; that is, not an exact integer. For example:

```
a := 10;  
b := 5;  
IF a/b=2 THEN  
  
...
```

As the result of a/b is not an integer, this condition is not necessarily satisfied.

Basic examples

The following examples illustrate the data type `num`:

Example 1

```
VAR num reg1;  
...  
reg1 := 3;  
reg1 is assigned the value 3.
```

Example 2

```
a := 10 DIV 3;  
b := 10 MOD 3;
```

Integer division where `a` is assigned an integer ($=3$) and `b` is assigned the remainder ($=1$).

Predefined data

There is some predefined data in the system. For example the constant `pi` (π) is defined.

```
CONST num pi := 3.1415926;
```

Limitations

Literal values between -8388607 to 8388608 assigned to a `num` variable are stored as exact integers.

Continues on next page

If a literal that has been interpreted as a `dnum` is assigned/used as a `num`, it is automatically converted to a `num`.

Related information

For information about	See
Numeric values using datatype <code>dnum</code>	dnum - Double numeric values on page 1649
Numeric expressions	<i>Technical reference manual - RAPID Overview, section Basic RAPID programming - Expressions</i>
Operations using numeric values	<i>Technical reference manual - RAPID Overview, section Basic RAPID programming - Expressions</i>

3 Data types

3.48 opcalc - Arithmetic Operator RobotWare Base

3.48 opcalc - Arithmetic Operator

Usage

`opcalc` is used to represent an arithmetic operator in arguments to RAPID functions or instructions.

Description

An `opcalc` constant is intended to be used to define the type of arithmetic operation.

Examples

The following example illustrates the data type `opcalc`:

Example 1

```
res := StrDigCalc(str1, OpAdd, str2);
```

`res` is assigned the result of the addition operation on the values represented by the strings `str1` and `str2`. `OpAdd` is of datatype `opcalc`.

Predefined data

The following symbolic constants of the data type `opcalc` are predefined and is used to define the type of arithmetic operation used, for instance, in function `StrDigCalc`.

Constant	Value	Comment
<code>OpAdd</code>	1	Addition (+)
<code>OpSub</code>	2	Substraction (-)
<code>OpMult</code>	3	Multiplication (*)
<code>OpDiv</code>	4	Division (/)
<code>OpMod</code>	5	Modulus (%)

Characteristics

`opcalc` is an alias data type for `num` and consequently inherits its characteristics.

Related information

For information about	See
Data types in general, alias data types	<i>Technical reference manual - RAPID Overview</i>
Arithmetic operations on digital strings.	StrDigCalc - Arithmetic operations with data-type stringdig on page 1480

3.49 opnum - Comparison operator

Usage

`opnum` is used to represent an operator for comparisons in arguments to RAPID functions or instructions.

Description

An `opnum` constant is intended to be used to define the type of comparison when checking values in generic instructions.

Basic examples

The following example illustrates the data type `opnum`:

Example 1

```
TriggCheckIO checkgrip, 100, airok, EQ, 1, intnol;
```

Predefined data

The following symbolic constants of the data type `opnum` are predefined and is used to define the type of comparison used, for instance, in instruction `TriggCheckIO`.

Value	Symbolic constant	Comment
1	LT	Less than
2	LTEQ	Less than or equal to
3	EQ	Equal to
4	NOTEQ	Not equal to
5	GTEQ	Greater than or equal to
6	GT	Greater than

Characteristics

`opnum` is an alias data type for `num` and consequently inherits its characteristics.

Related information

For information about	See
Data types in general, alias data types	<i>Technical reference manual - RAPID Overview, section Basic characteristics - Data types</i>
Define I/O check at a fixed position	TriggCheckIO - Defines I/O check at a fixed position on page 900

3 Data types

3.50 orient - Orientation *RobotWare Base*

3.50 orient - Orientation

Usage

`orient` is used for orientations (such as the orientation of a tool) and rotations (such as the rotation of a coordinate system).

Description

The orientation is described in the form of a quaternion which consists of four components: `q1`, `q2`, `q3`, and `q4`.

Basic examples

The following example illustrates the data type `orient`:

Example 1

```
VAR orient orient1;  
.  
orient1 := [1, 0, 0, 0];
```

The `orient1` orientation is assigned the value `q1=1, q2-q4=0`; this corresponds to no rotation.

Components

The data type `orient` has the following components:

`q1`

Data type: `num`
Quaternion 1.

`q2`

Data type: `num`
Quaternion 2.

`q3`

Data type: `num`
Quaternion 3.

`q4`

Data type: `num`
Quaternion 4.

Continues on next page

What is a Quaternion?

The orientation of a coordinate system (such as that of a tool) is described by a rotational matrix that describes the direction of the axes of the coordinate system in relation to a reference system (see the following figure).

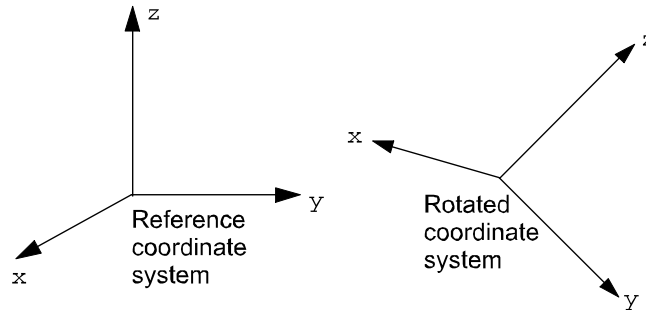

xx0500002376

The rotated coordinate systems axes (x, y, z) are vectors which can be expressed in the reference coordinate system as follows:

$$\mathbf{x} = (x_1, x_2, x_3)$$

$$\mathbf{y} = (y_1, y_2, y_3)$$

$$\mathbf{z} = (z_1, z_2, z_3)$$

This means that the x-component of the x-vector in the reference coordinate system will be x_1 , the y-component will be x_2 , and so on.

These three vectors can be put together in a matrix (a rotational matrix) where each of the vectors form one of the columns:

$$\begin{bmatrix} x_1 & y_1 & z_1 \\ x_2 & y_2 & z_2 \\ x_3 & y_3 & z_3 \end{bmatrix}$$

xx0500002381

A quaternion is just a more concise way to describe this rotational matrix; the quaternions are calculated based on the elements of the rotational matrix:

$q1 = \frac{\sqrt{x_1+y_2+z_3+1}}{2}$	
$q2 = \frac{\sqrt{x_1-y_2-z_3+1}}{2}$	sign $q2 = \text{sign}(y_3-z_2)$
$q3 = \frac{\sqrt{y_2-x_1-z_3+1}}{2}$	sign $q3 = \text{sign}(z_1-x_3)$
$q4 = \frac{\sqrt{z_3-x_1-y_2+1}}{2}$	sign $q4 = \text{sign}(x_2-y_1)$

Continues on next page

3 Data types

3.50 orient - Orientation

RobotWare Base

Continued

Example 1

A tool is orientated so that its Z'-axis points straight ahead (in the same direction as the X-axis of the base coordinate system). The Y'-axis of the tool corresponds to the Y-axis of the base coordinate system (see the following figure). How is the orientation of the tool defined in the position data (`robtarget`)?

The orientation of the tool in a programmed position is normally related to the coordinate system of the work object used. In this example, no work object is used and the base coordinate system is equal to the world coordinate system. Thus, the orientation is related to the base coordinate system.

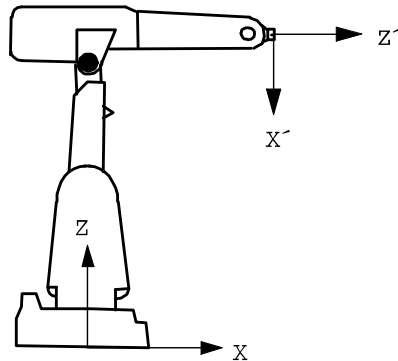

xx0500002377

The axes will then be related as follows:

$$x' = -z = (0, 0, -1)$$

$$y' = y = (0, 1, 0)$$

$$z' = x = (1, 0, 0)$$

Which corresponds to the following rotational matrix:

$$\begin{bmatrix} 0 & 0 & 1 \\ 0 & 1 & 0 \\ -1 & 0 & 0 \end{bmatrix}$$

xx0500002388

The rotational matrix provides a corresponding quaternion:

$q1 = \frac{\sqrt{0+1+0+1}}{2} = \frac{\sqrt{2}}{2} = 0.707$	
$q2 = \frac{\sqrt{0-1-0+1}}{2} = 0$	
$q3 = \frac{\sqrt{1-0-0+1}}{2} = \frac{\sqrt{2}}{2} = 0.707$	sign q3 = sign (1+1) = +
$q4 = \frac{\sqrt{0-0-1+1}}{2} = 0$	

Continues on next page

Example 2

The direction of the tool is rotated 30° about the X'- and Z'-axes in relation to the wrist coordinate system (see the following figure). How is the orientation of the tool defined in the tool data?

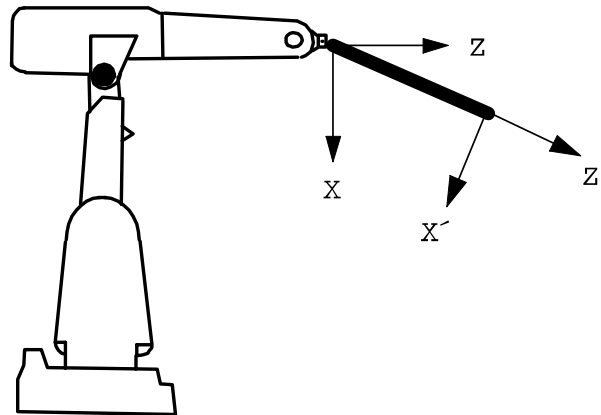

xx0500002378

The axes will then be related as follows:

$$x' = (\cos 30^\circ, 0, -\sin 30^\circ)$$

$$y' = (0, 1, 0)$$

$$z' = (\sin 30^\circ, 0, \cos 30^\circ)$$

Which corresponds to the following rotational matrix:

$$\begin{bmatrix} \cos 30^\circ & 0 & \sin 30^\circ \\ 0 & 1 & 0 \\ -\sin 30^\circ & 0 & \cos 30^\circ \end{bmatrix}$$

xx0500002393

The rotational matrix provides a corresponding quaternion:

$q1 = \frac{\sqrt{\cos 30^\circ + 1 + \cos 30^\circ + 1}}{2} = 0.965926$	
$q2 = \frac{\sqrt{\cos 30^\circ - 1 - \cos 30^\circ + 1}}{2} = 0$	
$q3 = \frac{\sqrt{1 - \cos 30^\circ - \cos 30^\circ + 1}}{2} = 0.258819$	sign q3 = sign (sin 30° + sin 30°) = +
$q4 = \frac{\sqrt{\cos 30^\circ - \cos 30^\circ - 1 + 1}}{2} = 0$	

Structure

```
< dataobject of orient >
  < q1 of num >
  < q2 of num >
  < q3 of num >
  < q4 of num >
```

Limitations

The orientation must be normalized; that is, the sum of the squares must equal 1:

Continues on next page

3 Data types

3.50 orient - Orientation

RobotWare Base

Continued

$$q_1^2 + q_2^2 + q_3^2 + q_4^2 = 1$$

Related information

For information about	See
Operations on orientations	<i>Technical reference manual - RAPID Overview, section Basic Characteristics - Expressions</i>

3.51 paridnum - Type of parameter identification

Usage

`paridnum` is used to represent an integer with a symbolic constant.

Description

A `paridnum` constant is intended to be used for parameter identification such as load identification of tool or payload or external manipulator load.

Basic examples

The following example illustrates the data type `paridnum`:

Example 1

```
TEST ParIdRobValid (TOOL_LOAD_ID)
CASE ROB_LOAD_VAL:
! Possible to do load identification of tool in actual robot type
...
CASE ROB_LM1_LOAD_VAL:
! Only possible to do load identification of tool with
! IRB 6400FHD if actual load < 200 kg
...
CASE ROB_NOT_LOAD_VAL:
! Not possible to do load identification of tool in actual robot
type
...
ENDTEST
```

Use of predefined constant `TOOL_LOAD_ID` of data type `paridnum`.

Predefined data

The following symbolic constants of the data type `paridnum` are predefined and is used as arguments in the following instructions, `ParIdRobValid`, `ParIdPosValid`, `LoadId`, and `ManLoadIdProc`.

Value	Symbolic constant	Comment
1	TOOL_LOAD_ID	Identify tool load
2	PAY_LOAD_ID	Identify payload (see instruction <code>GripLoad</code>)
3	IRBP_K	Identify External Manipulator IRBP K load
4	IRBP_L	Identify External Manipulator IRBP L load
4	IRBP_C	Identify External Manipulator IRBP C load
4	IRBP_C_INDEX	Identify External Manipulator IRBP C_INDEX load
4	IRBP_T	Identify External Manipulator IRBP T load
5	IRBP_R	Identify External Manipulator IRBP R load
6	IRBP_A	Identify External Manipulator IRBP A load
6	IRBP_B	Identify External Manipulator IRBP B load
6	IRBP_D	Identify External Manipulator IRBP D load

Continues on next page

3 Data types

3.51 paridnum - Type of parameter identification

RobotWare Base

Continued



Note

Only `TOOL_LOAD_ID` and `PAY_LOAD_ID` is used in user defined RAPID Programs for load identification of the tool respectively the pay load for the robot.

Characteristics

`paridnum` is an alias data type for `num` and consequently inherits its characteristics.

Related information

For information about	See
Predefined program Load Identify	<i>Operating manual - IRC5 with FlexPendant</i>
Valid robot type	ParIdRobValid - Valid robot type for parameter identification on page 1392
Valid robot position	ParIdPosValid - Valid robot position for parameter identification on page 1389
Load identification with complete example	LoadId - Load identification of tool or payload on page 347
Load identification of external manipulators	ManLoadIdProc - Load identification of IRBP manipulators on page 354

3.52 paridvalidnum - Result of ParIdRobValid

Usage

paridvalidnum is used to represent an integer with a symbolic constant.

Description

A paridvalidnum constant is intended to be used for parameter identification, such as load identification of tool or payload, when checking the return value from function ParIdRobValid.

Basic examples

The following examples illustrate the data type paridvalidnum:

```

TEST ParIdRobValid (PAY_LOAD_ID)
  CASE ROB_LOAD_VAL:
    ! Possible to do load identification of payload in actual robot
    ! type
    ...
  CASE ROB_LM1_LOAD_VAL:
    ! Only possible to do load identification of payload
    ! with IRB 6400FHD if actual load < 200 kg
    ...
  CASE ROB_NOT_LOAD_VAL:
    ! Not possible to do load identification of payload
    ! in actual robot type
    ...
ENDTEST

```

Use of predefined constants ROB_LOAD_VAL, ROB_LM1_LOAD_VAL and ROB_NOT_LOAD_VAL of data type paridvalidnum.

Predefined data

The following symbolic constants of the data type paridvalidnum are predefined and is used for checking the return value from function ParIdRobValid.

Value	Symbolic constant	Comment
10	ROB_LOAD_VAL	Valid robot type for the current parameter identification
11	ROB_NOT_LOAD_VAL	Not valid robot type for the current parameter identification
12	ROB_LM1_LOAD_VAL	Valid robot type IRB 6400FHD for the current parameter identification if actual load < 200 kg

Characteristics

paridvalidnum is an alias data type for num and inherits its characteristics.

Related information

For information about	See
Predefined program Load Identify	Operating manual - IRC5 with FlexPendant

Continues on next page

3 Data types

3.52 paridvalidnum - Result of ParldRobValid

RobotWare Base

Continued

For information about	See
Valid robot type	ParldRobValid - Valid robot type for parameter identification on page 1392
Valid robot position	ParldPosValid - Valid robot position for parameter identification on page 1389
Load identification with complete example	LoadId - Load identification of tool or payload on page 347

3.53 pathrecid - Path recorder identifier

Usage

`pathrecid` is used to identify a breakpoint for the path recorder.

Description

The path recorder is a system function for recording the robot's executed path. Data of the type `pathrecid` can be linked to a specific path location by means of the instruction `PathRecStart`. The user can then order the recorder to perform a movement back to the path identifier by using the instruction `PathRecMoveBwd`.

Basic examples

The following example illustrates the data type `pathrecid`:

Example 1

```

VAR pathrecid start_id;
CONST robtarget p1 := [...];
CONST robtarget p2 := [...];
CONST robtarget p3 := [...];

PathRecStart start_id;
MoveL p1, vmax, z50, tool1;
MoveL p2, vmax, z50, tool1;
MoveL p3, vmax, z50, tool1;
IF(PathRecValidBwd (\ID := start_id)) THEN
  StorePath;
  PathRecMoveBwd \ID:=start_id;
  ...
ENDIF

```

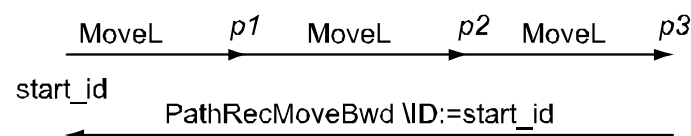

pathrecid_Ex

The preceding example will start the path recorder and the starting point will be tagged with the path identifier `start_id`. Thereafter, the robot will move forward with traditional move instructions and then move back to the start position again using the recorded path. To be able to run PathRecorder move instructions, the path level has to be changed with `StorePath`.

Characteristics

`pathrecid` is an non-value data type.

Continues on next page

3 Data types

3.53 pathrecid - Path recorder identifier

Path Recovery

Continued

Related information

For information about	See
Start - stop the path recorder	PathRecStart - Start the path recorder on page 531 PathRecStop - Stop the path recorder on page 534
Check for valid recorded path	PathRecValidBwd - Is there a valid backward path recorded on page 1399 PathRecValidFwd - Is there a valid forward path recorded on page 1402
Play the path recorder backward	PathRecMoveBwd - Move path recorder backwards on page 522
Play the path recorder forward	PathRecMoveFwd - Move path recorder forward on page 528
Characteristics of non-value data types	<i>Technical reference manual - RAPID Overview, section Basic characteristics - Data types</i>

3.54 pnpdata - Configure pick and place paths

Usage

`pnpdata` is used to configure pick and place paths.

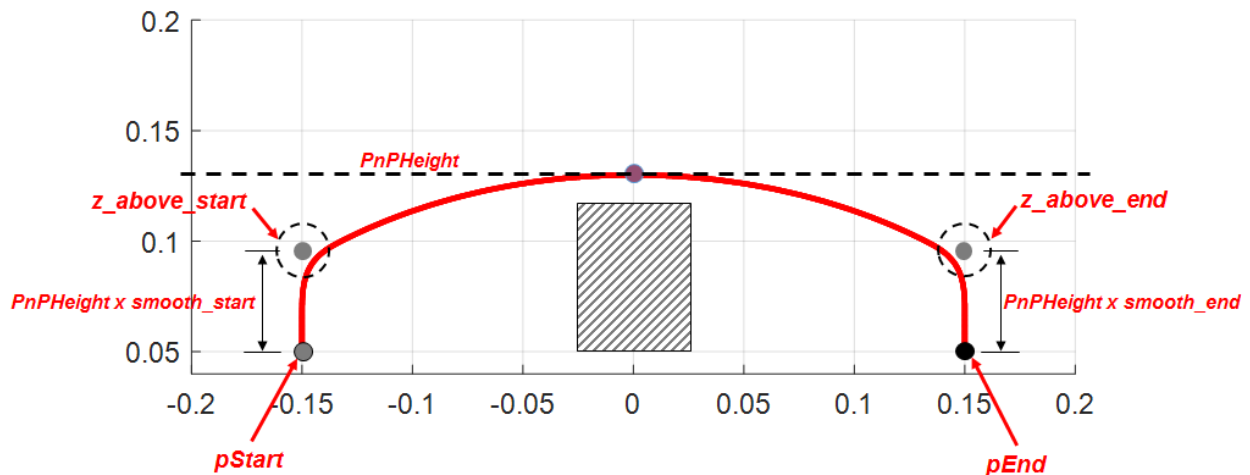

xx1700001194

Description

Data of the type `pnpdata` describes the heights of the vertical movements as a percentage of the total path height, and the zones of the generated corner paths.

Basic examples

See [MovePnP - Moves the robot along a pick and place path on page 483](#).

Components

The data type has the following components:

`smooth_start`

Data type: num

Percentage of the `PnPHeight` to describe the height of the vertical motion above the start point.

A lower value can significantly speed up the cycle time.

The default value is 100.

`smooth_end`

Data type: num

Percentage of the `PnPHeight` to describe the height of the vertical motion above the end point.

A lower value can significantly speed up the cycle time.

The default value is 100.

`z_above_start`

Data type: zonedata

Continues on next page

3 Data types

3.54 pnpdata - Configure pick and place paths

SCARA robots

Continued

Zone data for the movement. `z_above_start` describes the size of the generated corner path at the end of the vertical motion above the start point.

The default value is `z100`.

`z_above_end`

Data type: `zonedata`

Zone data for the movement. `z_above_end` describes the size of the generated corner path at the beginning of the vertical motion above the end point.

The default value is `z100`.

Structure

```
<dataobject of pnpdata>  
  <smooth_start of num>  
  <smooth_end of num>  
  <z_above_start of zonedata>  
  <z_above_end of zonedata>
```

Related information

For information about	See
Moving the robot along a pick and place path	MovePnP - Moves the robot along a pick and place path on page 483
	<i>Technical reference manual - RAPID Overview</i>

3.55 pos - Positions (only X, Y and Z)

Usage

`pos` is used for positions (only X, Y, and Z).

The `robtarget` data type is used for the robot's position including the orientation of the tool and the configuration of the axes.

Description

Data of the type `pos` describes the coordinates of a position: X, Y, and Z.

Basic examples

The following examples illustrate the data type `pos`:

Example 1

```
VAR pos pos1;  
...  
pos1 := [500, 0, 940];
```

The `pos1` position is assigned the value: X=500 mm, Y=0 mm, Z=940 mm.

Example 2

```
pos1.x := pos1.x + 50;
```

The `pos1` position is shifted 50 mm in the X-direction.

Components

The data type `pos` has the following components:

x

Data type: num

The X-value of the position.

y

Data type: num

The Y-value of the position.

z

Data type: num

The Z-value of the position.

Structure

```
< dataobject of pos >  
  < x of num >  
  < y of num >  
  < z of num >
```

Continues on next page

3 Data types

3.55 pos - Positions (only X, Y and Z)

RobotWare Base

Continued

Related information

For information about	See
Operations on positions	<i>Technical reference manual - RAPID Overview, section Basic Characteristics - Expressions</i>
Robot position including orientation	robtargent - Position data on page 1734

3.56 pose - Coordinate transformations

Usage

`pose` is used to change from one coordinate system to another.

Description

Data of the type `pose` describes how a coordinate system is displaced and rotated around another coordinate system. The data can, for example, describe how the tool coordinate system is located and oriented in relation to the wrist coordinate system.

Basic examples

The following examples illustrate the data type `pose`:

```
VAR pose frame1;
...
frame1.trans := [50, 0, 40];
frame1.rot := [1, 0, 0, 0];
```

The `frame1` coordinate transformation is assigned a value that corresponds to a displacement in position, where X=50 mm, Y=0 mm, Z=40 mm; there is, however, no rotation.

Components

The data type has the following components:

`trans`

translation

Data type: `pos`

The displacement in position (x, y, and z) of the coordinate system.

`rot`

rotation

Data type: `orient`

The rotation of the coordinate system.

Structure

```
< dataobject of pose >
  < trans of pos >
  < rot of orient >
```

Related information

For information about	See
What is a Quaternion?	orient - Orientation on page 1702

3 Data types

3.57 processtimes - process times

Continuous Application Platform (CAP)

3.57 processtimes - process times

Usage

`processtimes` is used to define the duration times for all status supervision phases in CAP, except phase MAIN, which is defined by the robot movement (see section *Supervision in Application manual - Continuous Application Platform*).

`processtimes` is a component of `capdata` and defines the timeout times for the following status supervision phases in CAP:

- PRE_START
- POST1
- POST2

The specified timeout time has to be larger than zero, if supervision should be used during the corresponding status supervision phase in CAP (see section *Supervision and process phases in Application manual - Continuous Application Platform*).

Components

pre

Data type: num

Defines the duration of the phase PRE_START in seconds. During that time all conditions defined for that phase have to be fulfilled.

post1

Data type: num

Defines the duration of the phase POST1 in seconds. During that time all conditions defined for that phase have to be fulfilled.

post2

Data type: num

Defines the duration of the phase POST2 in seconds. During that time all conditions defined for that phase have to be fulfilled.

Syntax

```
< data object of processtimes >  
  < pre of num >  
  < post1 of num >  
  < post2 of num >
```

Related information

	Described in:
<code>capdata</code> data type	capdata - CAP data on page 1614
<i>Continuous Application Platform</i>	<i>Application manual - Continuous Application Platform</i>

3.58 progdisp - Program displacement

Usage

`progdisp` is used to store the current program displacement of the robot and the external axes.

This data type does not normally have to be used since the data is set using the instructions `PDispSet`, `PDispOn`, `PDispOff`, `EOffsSet`, `EOffsOn`, and `EOffsOff`. It is only used to temporarily store the current value for later use.

Description

The current values for program displacement can be accessed using the system variable `C_PROGDISP`.

For more information, see the instructions `PDispSet`, `PDispOn`, `EOffsSet`, and `EOffsOn`.

Basic examples

The following example illustrates the data type `progdisp`:

Example 1

```
VAR progdisp progdisp1;
...
SearchL sen1, psearch, p10, v100, tool1;
PDispOn \ExeP:=psearch, *, tool1;
EOffsOn \ExeP:=psearch, *;
...
progdisp1:=C_PROGDISP;
PDispOff;
EOffsOff;
...
PDispSet progdisp1.pdisp;
EOffsSet progdisp1.eoffs;
```

First, a program displacement is activated from a searched position. Then, the current program displacement values are temporarily stored in the variable `progdisp1` and the program displacement is deactivated. Later on, re-activation is done using the instructions `PDispSet` and `EOffsSet`.

Predefined data

The system variable `C_PROGDISP` describes the current program displacement of the robot and external axes, and can always be accessed from the program. On the other hand, it can only be changed using a number of instructions, not by assignment.

The following default values for program displacement are set

- when using the restart mode **Reset RAPID**
- when loading a new program or a new module
- when starting program execution from the beginning
- when moving the program pointer to `main`

Continues on next page

3 Data types

3.58 progdisp - Program displacement

RobotWare Base

Continued

- when moving the program pointer to a routine
- when moving the program pointer in such a way that the execution order is lost.

```
VAR progdisp C_PROGDISP :=  
  [ [ [ 0, 0, 0 ], [ 1, 0, 0, 0 ] ], -> posedata  
  [ 0, 0, 0, 0, 0, 0 ] ]; -> extjointdata
```

Components

pdisp

program displacement

Data type: pose

The program displacement for the robot, expressed using a translation and an orientation. The translation is expressed in mm.

eoffs

external offset

Data type: extjoint

The offset for each of the external axes. If the axis is linear, the value is expressed in mm; if it is rotating, the value is expressed in degrees.

Structure

```
< dataobject of progdisp >  
  < pdisp of pose >  
    < trans of pos >  
      < x of num >  
      < y of num >  
      < z of num >  
    < rot of orient >  
      < q1 of num >  
      < q2 of num >  
      < q3 of num >  
      < q4 of num >  
  < eoffs of extjoint >  
    < eax_a of num >  
    < eax_b of num >  
    < eax_c of num >  
    < eax_d of num >  
    < eax_e of num >  
    < eax_f of num >
```

Related information

For information about	See
Instructions for defining program displacement	<i>Technical reference manual - RAPID Overview, section RAPID summary - Motion settings</i>
Coordinate systems	<i>Technical reference manual - RAPID Overview, section Motion and I/O principles - Coordinate systems</i>

3.59 rawbytes - Raw data

Usage

`rawbytes` is used as a general data container. It can be used for communication with I/O devices.

Description

`rawbytes` data can be filled with any type of data - num, byte, string - by means of support instructions/functions. In any variable of `rawbytes`, the system also stores the current length of valid bytes.

Basic examples

The following example illustrates the data type `rawbytes`:

Example 1

```

VAR rawbytes raw_data;
VAR num integer := 8;
VAR num float := 13.4;

ClearRawBytes raw_data;
PackRawBytes integer, raw_data, 1 \IntX := INT;
PackRawBytes float, raw_data, (RawBytesLen(raw_data)+1) \Float4;

```

In this example the variable `raw_data` of type `rawbytes` is first cleared, that is, all bytes set to 0 (same as default at declaration). Then in the first 2 bytes the value of `integer` is placed and in the next 4 bytes the value of `float`.

Limitations

A `rawbytes` variable may contain 0 to 1024 bytes.

Structure

`rawbytes` is a non-value data type.

At declaration of `rawbytes` variable, all bytes in `rawbytes` are set to 0 and the current length of valid bytes in the variable is set to 0.

Related information

For information about	See
Get the length of <code>rawbytes</code> data	RawBytesLen - Get the length of rawbytes data on page 1422
Clear the contents of <code>rawbytes</code> data	ClearRawBytes - Clear the contents of rawbytes data on page 145
Copy the contents of <code>rawbytes</code> data	CopyRawBytes - Copy the contents of rawbytes data on page 169
Pack DeviceNet header into <code>rawbytes</code> data	PackDNHeader - Pack DeviceNet Header into rawbytes data on page 505
Pack data into <code>rawbytes</code> data	PackRawBytes - Pack data into rawbytes data on page 508

Continues on next page

3 Data types

3.59 rawbytes - Raw data

RobotWare Base

Continued

For information about	See
Write rawbytes data	WriteRawBytes - Write rawbytes data on page 1108
Read rawbytes data	ReadRawBytes - Read rawbytes data on page 593
Unpack data from rawbytes data	UnpackRawBytes - Unpack data from rawbytes data on page 1013
File and I/O device handling	<i>Application manual - Controller software IRC5</i>

3.60 restartblkdata - blockdata for restart

Usage

restartblkdata is used to define the behavior of a CAP process at restart.

restartblkdata is a component of capdata and defines the following for a CAP process at restart, if:

- The robot should execute/block weaving stationary during process restart (weave_start).
- Robot movement restart should be delayed or not relative process restart (motion_delay).
- The phases START_PRE, PRE and END_PRE should be executed/blocked (pre_phase).
- A velocity different from main velocity should be used or not during start of the process (startspeed_phase).
- The phases START_POST1, POST1 and END_POST1 should be executed/blocked (post1_phase).
- The phases START_POST2, POST2 and END_POST2 should be executed/blocked (post2_phase).

Components

weave_start

Data type: bool

Value	Description
FALSE	Stationary weaving at restart until the process has started
TRUE	No stationary weaving at restart until the process has started

motion_delay

Data type: bool

Value	Description
FALSE	Delay of robot movement at restart after the process has started
TRUE	No delay of robot movement at restart after the process has started

pre_phase

Data type: bool

Value	Description
FALSE	Execute the phases PRE, PRE_START and END_PRE phase at restart
TRUE	Do NOT execute the phases PRE, PRE_START and END_PRE phase at restart

Continues on next page

3 Data types

3.60 restartblkdata - blockdata for restart

Continuous Application Platform (CAP)

Continued

startspeed_phase

Data type: bool

Value	Description
FALSE	Move the robot with start speed in the beginning of a restart
TRUE	Do NOT move the robot with start speed in the beginning of a restart, use main speed directly

post1_phase

Data type: bool

Value	Description
FALSE	Execute the phases START_POST1, POST1 and END_POST1 at restart
TRUE	Do NOT execute the phases START_POST1, POST1 and END_POST1 at restart

post2_phase

Data type: bool

Value	Description
FALSE	Execute the phases START_POST2, POST2 and END_POST2 at restart
TRUE	Do NOT execute the phases START_POST2, POST2 and END_POST2 at restart

Syntax

```
< data object of restartblkdata >  
  < weave_start of bool >  
  < motion_delay of bool >  
  < pre_phase of bool >  
  < startspeed_phase of bool >  
  < post1_phase of bool >  
  < post2_phase of bool >
```

Related information

	Described in:
capdata data type	capdata - CAP data on page 1614
<i>Continuous Application Platform</i>	<i>Application manual - Continuous Application Platform</i>

3.61 restartdata - Restart data for trigg signals

Usage

`restartdata` mirrors the pre- and postvalues of specified I/O signals (process signals) at the stop sequence of the robot movements. The I/O signals to supervise are specified in the instruction `TriggStopProc`.

`TriggStopProc` and `restartdata` are intended to be used for restart after program stop (STOP) or emergency stop (QSTOP) of own process instructions defined in RAPID (NOSTEPIN routines).

Description

`restartdata` mirrors the following data after program execution is stopped:

- valid restart data
- robot stopped on path or not
- prevalue of the I/O signals
- postvalue of the I/O signals
- number of flanks between pretime and posttime of the shadow signal for the ongoing process

Definition

The table shows the definition of the time point for reading the pre- and postvalues for the I/O signals.

Type of stop	Read time for I/O signal pre-value	Read time for I/O signal postvalue
STOP on path	When all robot axes are standing still	About 400 ms after the pretime
QSTOP off path	As soon as possible	About 400 ms after the pretime

Components

`restartstop`

valid restartdata after stop

Data type: `bool`

TRUE = Mirror last STOP or QSTOP

FALSE = Invalid restart data. All I/O signals values are set to -1.

`stoponpath`

stop on path

Data type: `bool`

TRUE = The robot is stopped on the path (STOP)

FALSE = The robot is stopped but not on the path (QSTOP)

`predo1val`

pre do1 value

Data type: `dionum`

Continues on next page

3 Data types

3.61 restartdata - Restart data for trigg signals

RobotWare Base

Continued

The prevalue of the digital signal “do1” specified in the argument DO1 in instruction TriggStopProc.

postdo1val

post do1 value

Data type: dionum

The postvalue of the digital signal “do1” specified in the argument DO1 in instruction TriggStopProc.

prego1val

pre go1 value

Data type: num

The prevalue of the digital group signal “go1” specified in the argument GO1 in instruction TriggStopProc.

postgo1val

post go1 value

Data type: num

The postvalue of the digital group signal “go1” specified in the argument GO1 in instruction TriggStopProc.

prego2val

pre go2 value

Data type: num

The prevalue of the digital group signal “go2” specified in the argument GO2 in instruction TriggStopProc.

postgo2val

post go2 value

Data type: num

The postvalue of the digital group signal “go2” specified in the argument GO2 in instruction TriggStopProc.

prego3val

pre go3 value

Data type: num

The prevalue of the digital group signal “go3” specified in the argument GO3 in instruction TriggStopProc.

postgo3val

post go3 value

Data type: num

The postvalue of the digital group signal “go3” specified in the argument GO3 in instruction TriggStopProc.

prego4val

pre go4 value

Continues on next page

Data type: num

The prevalue of the digital group signal “go4” specified in the argument GO4 in instruction TriggStopProc.

postgo4val

post go4 value

Data type: num

The postvalue of the digital group signal “go4” specified in the argument GO4 in instruction TriggStopProc.

preshadowval

pre shadow value

Data type: dionum

The prevalue of the digital signal “shadow” specified in the argument ShadowDO in instruction TriggStopProc.

shadowflanks

number of shadow flanks

Data type: num

The number of value transitions (flanks) of the digital signal “shadow” between the pretime and the posttime. The signal “shadow” is specified in the argument ShadowDO in instruction TriggStopProc.

postshadowval

post shadow value

Data type: dionum

The postvalue of the digital signal “shadow” specified in the argument ShadowDO in instruction TriggStopProc.

Structure

```
< dataobject of restartdata >
  < restartstop of bool >
  < stoponpath of bool >
  < predolval of dionum >
  < postdolval of dionum >
  < prego1val of num >
  < postgo1val of num >
  < prego2val of num >
  < postgo2val of num >
  < prego3val of num >
  < postgo3val of num >
  < prego4val of num >
  < postgo4val of num >
  < preshadowval of dionum >
  < shadowflanks of dionum >
  < postshadowval of dionum >
```

Continues on next page

3 Data types

3.61 restartdata - Restart data for trigg signals

RobotWare Base

Continued

Related information

For information about	See
Predefined process instructions	TriggL - Linear robot movements with events on page 935 TriggC - Circular robot movement with events on page 891
Setup mirror of restart data	TriggStopProc - Generate restart data for trigg signals at stop on page 975
Move backwards on path	StepBwdPath - Move backwards one step on path on page 804
<i>Advanced RAPID</i>	<i>Product specification - Controller software IRC5</i>

3.62 rmqheader - RAPID Message Queue Message header *FlexPendant Interface, PC Interface, or Multitasking*

3.62 rmqheader - RAPID Message Queue Message header

Usage

`rmqheader` (*RAPID Message Queue Header*) is used for reading the data structure of the data in a message of type `rmqmessage`.

Description

The header part of a non-value data type `rmqmessage` converted to the value data type `rmqheader`.

Examples

Basic examples of the data type `rmqheader` are illustrated below.

Example 1

```
VAR rmqmessage message;
VAR rmqheader header;
...
RMQGetMessage message;
RMQGetMsgHeader message \Header:=header;
```

Copy and convert the `rmqheader` information from an `rmqmessage` message.

Components

`datatype`

Data type: `string`

The name of the data type used, e.g `num`, `string` or some other value data type.

`ndim`

Number of Dimensions

Data type: `num`

Number of array dimensions.

`dim1`

Size of first dimension

Data type: `num`

The size of the first dimension. 0 if not used.

`dim2`

Size of second dimension

Data type: `num`

The size of the second dimension. 0 if not used.

`dim3`

Size of third dimension

Data type: `num`

The size of the third dimension. 0 if not used.

Continues on next page

3 Data types

3.62 rmqheader - RAPID Message Queue Message header

FlexPendant Interface, PC Interface, or Multitasking

Continued

Structure

```
<dataobject of rmqheader>  
  <datatype of string>  
  <ndim of num>  
  <dim1 of num>  
  <dim2 of num>  
  <dim3 of num>
```

Related information

For information about	See
Description of the RAPID Message Queue functionality	<i>Application manual - Controller software IRC5, section RAPID Message Queue.</i>
Extract the header data from an rmqmessage	RMQGetMsgHeader - Get header information from an RMQ message on page 634
RMQ Message	rmqmessage - RAPID Message Queue message on page 1731

3.63 rmqmessage - RAPID Message Queue message FlexPendant Interface, PC Interface, or Multitasking

3.63 rmqmessage - RAPID Message Queue message

Usage

`rmqmessage` (*RAPID Message Queue Message*) is used for temporary storage of communication data.

Description

The data type `rmqmessage` is the message used to store data in while communicating between different RAPID tasks or Robot Application Builder clients with RMQ functionality. It contains information about the type of data sent, the dimensions of the data, the identity of the sender and the actual data.

An `rmqmessage` is a big data type (about 3000 bytes big), and it is recommended that the variable is reused to save RAPID memory.

Basic examples

The following example illustrates the data type `rmqmessage`:

Example 1

```
VAR rmqmessage rmqmessage1;
VAR string myrecredata;
...
RMQGetMsgData rmqmessage1, myrecredata;
```

The variable `rmqmessage1` is defined and can be used in an RMQ (RAPID Message Queue) command. In this example, the data part within the `rmqmessage1` is copied to the variable `myrecredata`.

Characteristics

`rmqmessage` is a non-value data type and cannot be used in value-oriented operations.

Related information

For information about	See
Description of the RAPID Message Queue functionality	Application manual - Controller software IRC5, section RAPID Message Queue.
RMQ Header	rmqheader - RAPID Message Queue Message header on page 1729
Extract the header data from an <code>rmqmessage</code>	RMQGetMsgHeader - Get header information from an RMQ message on page 634
Order and enable interrupts for a specific data type	IRMQMessage - Orders RMQ interrupts for a data type on page 301
Get the first message from a RAPID Message Queue.	RMQGetMessage - Get an RMQ message on page 628
Send data to the queue of a RAPID task or Robot Application Builder client, and wait for an answer from the client.	RMQSendWait - Send an RMQ data message and wait for a response on page 644
Extract the data from an <code>rmqmessage</code>	RMQGetMsgData - Get the data part from an RMQ message on page 631

3 Data types

3.64 rmqslot - Identity number of an RMQ client *FlexPendant Interface, PC Interface, or Multitasking*

3.64 rmqslot - Identity number of an RMQ client

Usage

`rmqslot` (*RAPID Message Queue Slot*) is used when communicating with an RMQ or a Robot Application Builder client.

Description

The `rmqslot` is an identity number of a RAPID Message Queue configured for a RAPID task or the identity number of a Robot Application Builder client.

Basic examples

The following example illustrates the data type `rmqslot`:

Example 1

```
VAR rmqslot rmqslot1;  
RMQFindSlot rmqslot1, "RMQ_T_ROB1";  
...
```

The variable `rmqslot1` is defined and can be used in the instruction `RMQFindSlot` to get the identity number of the RAPID Message Queue "RMQ_T_ROB1" configured for the RAPID task "T_ROB1".

Characteristics

`rmqslot` is a non-value data type and cannot be used in value-oriented operations.

Related information

For information about	See
Description of the RAPID Message Queue functionality	<i>Application manual - Controller software IRC5</i> , section <i>RAPID Message Queue</i> .
Find the identity number of a RAPID Message Queue task or Robot Application Builder client.	RMQFindSlot - Find a slot identity from the slot name on page 626
Send data to the queue of a RAPID task or Robot Application Builder client.	RMQSendMessage - Send an RMQ data message on page 640
Send data to a client, and wait for an answer from the client.	RMQSendWait - Send an RMQ data message and wait for a response on page 644
Get the slot name from a specified slot identity	RMQGetSlotName - Get the name of an RMQ client on page 1445

3.65 robjoint - Joint position of robot axes

Usage

`robjoint` is used to define the position in degrees of the robot axes.

Description

Data of the type `robjoint` is used to store axis positions in degrees of the robot axis 1 to 6. Axis position is defined as the rotation in degrees for the respective axis (arm) in a positive or negative direction from the axis calibration position.

Components

`rax_1`

robot axis 1

Data type: `num`

The position of robot axis 1 in degrees from the calibration position.

...

`rax_6`

robot axis 6

Data type: `num`

The position of robot axis 6 in degrees from the calibration position.

Structure

```
< dataobject of robjoint >
  < rax_1 of num >
  < rax_2 of num >
  < rax_3 of num >
  < rax_4 of num >
  < rax_5 of num >
  < rax_6 of num >
```

Related information

For information about	See
Joint position data	jointtarget - Joint position data on page 1679
Move to joint position	MoveAbsJ - Moves the robot to an absolute joint position on page 395

3 Data types

3.66 robtarget - Position data

RobotWare Base

3.66 robtarget - Position data

Usage

`robtarget` (*robot target*) is used to define the position of the robot and additional axes.

Description

Position data is used to define the position in the move instructions to which the robot and additional axes are to move.

As the robot is able to achieve the same position in several different ways, the axis configuration is also specified. This defines the axis values, if these are in any way ambiguous, for example:

- if the robot is in a forward or backward position,
- if axis 4 points downwards or upwards,
- if axis 6 has a negative or positive revolution.



WARNING

The position is defined based on the coordinate system of the work object, including any program displacement. If the position is programmed with some other work object than the one used in the instruction, the robot will not move in the expected way. Make sure that you use the same work object as the one used when programming move instructions. Incorrect use can injure someone or damage the robot or other equipment.

Basic examples

The following examples illustrate the data type `robtarget`:

Example 1

```
CONST robtarget p15 := [ [600, 500, 225.3], [1, 0, 0, 0], [1, 1, 0, 0], [ 11, 12.3, 9E9, 9E9, 9E9, 9E9] ];
```

A position `p15` is defined as follows:

- The position of the robot: $x = 600$, $y = 500$, and $z = 225.3$ mm in the object coordinate system.
- The orientation of the tool in the same direction as the object coordinate system.
- The axis configuration of the robot: axes 1 and 4 in position $90-180^\circ$, axis 6 in position $0-90^\circ$.
- The position of the additional logical axes, a (11) and b (12.3), expressed in degrees or mm (depending on the type of axis). Axes c to f are undefined (9E9).

Example 2

```
VAR robtarget p20;  
...  
p20 := CRobT(\Tool:=tool\wobj:=wobj0);  
p20 := Offs(p20,10,0,0);
```

Continues on next page

The position `p20` is set to the same position as the current position of the robot by calling the function `CRobT`. The position is then moved 10 mm in the x-direction.

Components

`trans`

translation

Data type: `pos`

The position (x, y, and z) of the tool center point expressed in mm.

The position is specified in relation to the current object coordinate system, including program displacement. If no work object is specified then this is the world coordinate system.

`rot`

rotation

Data type: `orient`

The orientation of the tool, expressed in the form of a quaternion (q1, q2, q3, and q4).

The orientation is specified in relation to the current object coordinate system including program displacement. If no work object is specified then this is the world coordinate system.

`robconf`

robot configuration

Data type: `confdata`

The axis configuration of the robot (`cf1`, `cf4`, `cf6`, and `cfx`). For articulated robots, this is defined in the form of the current quarter revolution of axis 1, axis 4, and axis 6. The meaning of the component `cfx` is dependent on robot type. For more information, see data type [confdata - Robot configuration data on page 1637](#).

`extax`

external axes

Data type: `extjoint`

The position of the additional axes.

The position is defined as follows for each individual axis (`eax_a`, `eax_b` . . . `eax_f`):

- For rotating axes, the position is defined as the rotation in degrees from the calibration position.
- For linear axes, the position is defined as the distance in mm from the calibration position.

Additional axes `eax_a` . . . are logical axes. The relationship between the logical axis number and the physical axis number is defined in the system parameters.

Continues on next page

3 Data types

3.66 robtargt - Position data

RobotWare Base

Continued

The value 9E9 is defined for axes which are not connected. If the axes defined in the position data differ from the axes that are actually connected at program execution then the following applies:

- If the position is not defined in the position data (value 9E9) then the value will be ignored if the axis is connected and not activated. But if the axis is activated then it will result in an error.
- If the position is defined in the position data although the axis is not connected then the value is ignored.

No movement is performed but no error is generated for an axis with valid position data if the axis is not activated.

If an additional axis is running in independent mode and a new movement shall be performed by the robot and its additional axes, then the position data for the additional axes in independent mode must not be 9E9. The data must be an arbitrary value that is not used by the system.

Structure

```
< dataobject of robtargt >
  < trans of pos >
    < x of num >
    < y of num >
    < z of num >
  < rot of orient >
    < q1 of num >
    < q2 of num >
    < q3 of num >
    < q4 of num >
  < robconf of confdata >
    < cf1 of num >
    < cf4 of num >
    < cf6 of num >
    < cfx of num >
  < extax of extjoint >
    < eax_a of num >
    < eax_b of num >
    < eax_c of num >
    < eax_d of num >
    < eax_e of num >
    < eax_f of num >
```

Related information

For information about	See
Move instructions	<i>Technical reference manual - RAPID Overview, section RAPID Summary - Motion</i>
Coordinate systems	<i>Technical reference manual - RAPID Overview, section Motion and I/O Principles - Coordinate Systems</i>
Handling configuration data	<i>Technical reference manual - RAPID Overview, section Motion and I/O Principles - Robot configuration</i>

Continues on next page

For information about	See
Configuration of additional axes	<i>Application manual - Additional axes and standalone controller</i>
What is a quaternion?	orient - Orientation on page 1702
confdata	confdata - Robot configuration data on page 1637

3 Data types

3.67 sensor - External device descriptor *Robor Reference Interface*

3.67 sensor - External device descriptor

Usage

`sensor` is a descriptor to the external device to connect to.

Description

The descriptor for a device on the RAPID level is encapsulated in the record data type `sensor`. It holds information about the sensor device such as id, error code and sensor communication state.

Components

`id`

Data type: `num`

The internal identifier of the device, which will be set on the first operation with the device from RAPID level. (Not implemented yet).

`error`

Data type: `num`

The `error` parameter is set when parameter `state` is set to `STATE_ERROR`. When `state` goes from `STATE_ERROR` to `STATE_CONNECTED` parameter `error` is set to 0.

Error number	Error
0	No error.
112600	Communication interface initialization failed.
112602	Communication interface error.

`state`

Data type: `sensorstate`

Reflects the actual communication state of the device.

Examples

Example of the data type `sensor` is shown below.

Example 1

```
PERS sensor AnyDevice;
PERS robdata DataOut := [[0,0,0,0,0,0,0,0,0,0,0,0,0,0,0,0,0,0]];
PERS sensdata DataIn :=
    ["No",[0,0,0,0,0,0,0,0,0,0,0,0,0,0,0,0,0,0]];
VAR num SampleRate:=64;
...
! Setup Interface Procedure
PROC RRI_Open()
    SiConnect AnyDevice;
    ! Send and receive data cyclic with 64 ms rate
    SiGetCyclic AnyDevice, DataIn, SampleRate;
    SiSetCyclic AnyDevice, DataOut, SampleRate;
ENDPROC
```

Continues on next page

When calling routine `RRI_Open`, first a connection to the device `AnyDevice` is opened. Then, cyclic transmission is started at rate `SampleRate`.

Structure

```
<dataobject of sensor>
  <id of num>
  <error of num>
  <state of sensorstate>
```

Related information

For information about	See
Establish a connection to an external system.	SiConnect - Sensor Interface Connect on page 721.
Close connection to an external system.	SiClose - Sensor Interface Close on page 724.
Register data for cyclic transmission.	SiSetCyclic - Sensor Interface Set Cyclic on page 732.
Subscribe on cyclic data transmission.	SiGetCyclic - Sensor Interface Get Cyclic on page 726
Communication state of a device.	sensorstate - Communication state of the device on page 1740.
<i>Robot Reference Interface</i>	<i>Application manual - Controller software IRC5</i>

3 Data types

3.68 sensorstate - Communication state of the device

Robot Reference Interface

3.68 sensorstate - Communication state of the device

Usage

`sensorstate` is used to represent an actual communication state of a device.

Description

A `sensorstate` constant is used to reflect the actual communication state of a device. It can be used from RAPID to evaluate the state of the connection with the sensor.

Predefined data

The following symbolic constants of the data type `sensorstate` are predefined and can be used to evaluate what communication state the device is in.

Constant	Value
STATE_ERROR	-1
STATE_UNDEFINED	0
STATE_CONNECTED	1
STATE_OPERATING	2
STATE_CLOSED	3

Characteristics

`sensorstate` is an alias data type for `num` and consequently inherits its characteristics.

Related information

For information about	See
Establish a connection to an external system.	SiConnect - Sensor Interface Connect on page 721.
Close connection to an external system.	SiClose - Sensor Interface Close on page 724.
Register data for cyclic transmission.	SiSetCyclic - Sensor Interface Set Cyclic on page 732.
Subscribe on cyclic data transmission.	SiGetCyclic - Sensor Interface Get Cyclic on page 726
Descriptor to the external device.	sensor - External device descriptor on page 1738.
<i>Robot Reference Interface</i>	<i>Application manual - Controller software IRC5</i>

3.69 sensorvardata - Multiple variable setup data for sensor interface

Usage

`sensorvardata` is used to setup the needed information for the different data points that is handled by the `ReadVarArr` and `WriteVarArr` commands.

Components

The data type has the following components:

`varnumber`

Data type: `num`

Defines the variable number to be read/written.

`sensordatatype`

Data type: `num`

The datatype the value is represented by. The value will be converted to the given type before it is sent or after it is received over the sensor communication link.

Valid values are:

Value	Description
0	INT16
1	UINT16
2	DOUBLE

When using a sensor from ServoRobot® over EtherNet link the `sensordatatype` 2 (double) will always be used. For all other types of sensors and communication `sensordatatype` 0 or 1 must be used

`raw`

Data type: `bool`

If this flag is true no internal modification of the data is done before or after it is sent over the protocol to/from the device. The value sent/received will have the same bit representation as it had on the communication link.

`raw` is not available for `sensordatatype` 2.

`scale`

Data type: `num`

Set the scale factor used for scaling data values. Valid values are 1, 10 or 100. A value sent to a device via `WriteVarArr` will be multiplied by the scale factor before it is sent and a value read from a device via `ReadVarArr` will be divided by the scale factor before it is returned.

`scale` is not available for `sensordatatype` 2.

`value`

Data type: `dnum`

The value that shall be read/written to/from the device.

Continues on next page

3 Data types

3.69 sensorvardata - Multiple variable setup data for sensor interface

Sensor Interface

Continued

Structure

```
< data object of sensorvardata >
  < varnumber of num >
  < sensordatatype of num >
  < raw of bool >
  < scale of num >
  < value of dnum >
```

Related information

For information about	See
Read multiple variables from a device	ReadVarArr - Read multiple variables from a sensor device on page 596
Write multiple variables to a device	WriteVarArr - Write multiple variables to a sensor device on page 1114
Configuration of sensor communication	<i>Technical reference manual - RAPID Overview</i>
Configuration of sensor communication	<i>Technical reference manual - System parameters</i>

3.70 shapedata - World zone shape data

Usage

shapedata is used to describe the geometry of a world zone.

Description

World zones can be defined in 4 different geometrical shapes:

- a straight box, with all sides parallel to the world coordinate system and defined by a `WZBoxDef` instruction
- a sphere, defined by a `WZSphDef` instruction
- a cylinder, parallel to the z axis of the world coordinate system and defined by a `WZCylDef` instruction
- a joint space area for robot and/or external axes, defined by the instruction `WZHomeJointDef` or `WZLimJointDef`

The geometry of a world zone is defined by one of the previous instructions and the action of a world zone is defined by the instruction `WZLimSup` or `WZDOSet`.

Basic examples

The following example illustrates the data type shapedata:

Example 1

```

VAR wzstationary pole;
VAR wzstationary conveyor;
...
PROC ...
  VAR shapedata volume;
  ...
  WZBoxDef \Inside, volume, p_corner1, p_corner2;
  WZLimSup \Stat, conveyor, volume;
  WZCylDef \Inside, volume, p_center, 200, 2500;
  WZLimSup \Stat, pole, volume;
ENDPROC

```

A conveyor is defined as a box and the supervision for this area is activated. A pole is defined as a cylinder and the supervision of this zone is also activated. If the robot reaches one of these areas, the motion is stopped.

Characteristics

shapedata is a non-value data type.

Related information

For information about	See
World Zones	<i>Technical reference manual - RAPID Overview, section RAPID summary - Motion settings</i>
Define box-shaped world zone	WZBoxDef - Define a box-shaped world zone on page 1116

Continues on next page

3 Data types

3.70 shapedata - World zone shape data

World Zones

Continued

For information about	See
Define sphere-shaped world zone	WZSphDef - Define a sphere-shaped world zone on page 1141
Define cylinder-shaped world zone	WZCylDef - Define a cylinder-shaped world zone on page 1118
Define a world zone for home joints	WZHomeJointDef - Define a world zone for home joints on page 1131
Define a world zone for limit joints	WZLimJointDef - Define a world zone for limitation in joints on page 1134
Activate world zone limit supervision	WZLimSup - Activate world zone limit supervision on page 1138
Activate world zone digital output set	WZDOSet - Activate world zone to set digital output on page 1123

3.71 signalorigin - Describes the I/O signal origin

Usage

`signalorigin` is used to represent an integer with a symbolic constant.

Description

The predefined symbolic constants of type `signalorigin` can be used to check the origin of an I/O signal. It is intended to be used when checking the return value from the function `GetSignalOrigin`.

Basic examples

The following example illustrates the data type `signalorigin`:

Example 1

```

VAR signalorigin sigorig;
VAR string signalname;
...
sigorig := GetSignalOrigin(mydo, signalname);
IF sigorig = SIGORIG_NONE THEN
  TPWrite "The signal named "+ArgName(mydo)+" can not be used";
  Stop;
ELSEIF (sigorig = SIGORIG_CFG) OR (sigorig = SIGORIG_ALIAS) THEN
  SetDO mydo, 1;
...
ELSE
  TPWrite "Unknown origin "+ValToStr(sigorig);
  Stop;
ENDIF

```

The signal origin will be stored in the variable `sigorig`.

Predefined data

Following constants of type `signalorigin` are predefined:

Return value	Symbolic constant	Comment
0	SIGORIG_NONE	The I/O signal variable is declared in RAPID and has no alias coupling.
1	SIGORIG_CFG	The signal is configured in I/O configuration.
2	SIGORIG_ALIAS	The I/O signal variable is declared in RAPID and has an alias coupling to an I/O signal configured in I/O configuration.

Characteristics

`signalorigin` is an alias data type for `num` and thus inherits its properties.

Continues on next page

3 Data types

3.71 signalorigin - Describes the I/O signal origin

RobotWare Base

Continued

Related information

For information about	See
Getting information about the origin of an I/O signal	GetSignalOrigin - Get information about the origin of an I/O signal on page 1304

3.72 signalxx - Digital and analog signals

Usage

Data types within `signalxx` are used for digital and analog input and output signals. The names of the signals are defined in the system parameters and are consequently not to be defined in the program.

Description

Data type	Used for
<code>signalai</code>	analog input signals
<code>signalao</code>	analog output signals
<code>signaldi</code>	digital input signals
<code>signaldo</code>	digital output signals
<code>signalgi</code>	groups of digital input signals
<code>signalgo</code>	groups of digital output signals

Variables of the type `signalxo` only contain a reference to the signal. The value is set using the instructions `SetDO`, `SetGO`, and `SetAO`.

Variables of the type `signalxi` contain a reference to a signal as well as the possibility to retrieve the value directly in the program, if used in value context.

The value of an input signal can be read directly in the program, e.g.:

```
! Digital input
IF dil = 1 THEN ...

! Digital group input
IF gil = 5 THEN ...

! Analog input
IF ail > 5.2 THEN ...
```

It can also be used in assignments, e.g.:

```
VAR num current_value;

! Digital input
current_value := dil;

! Digital group input
current_value := gil;

! Analog input
current_value := ail;
```

Predefined data

The signals defined in the system parameters can always be accessed from the program by using the predefined signal variables (installed data). However, it should be noted that if other data with the same name is defined then these signals cannot be used.

Continues on next page

3 Data types

3.72 signalxx - Digital and analog signals

RobotWare Base

Continued

Limitations

Data of the data type `signalxx` must not be defined in the program. However, if this is in fact done then an error message will be displayed as soon as an instruction or function that refers to this signal is executed. The data type can, on the other hand, be used as a parameter when declaring a routine.

Characteristics

`signalxx` is a semi-value data type that permits value oriented operations.

Error handling

The following recoverable errors are generated and can be handled in an error handler. The system variable `ERRNO` will be set to:

Name	Cause of error
<code>ERR_NO_ALIASIO_DEF</code>	The signal variable is a variable declared in RAPID. It has not been connected to an I/O signal defined in the I/O configuration with instruction <code>AliasIO</code> .
<code>ERR_NORUNUNIT</code>	There is no contact with the I/O device.

Related information

For information about	See
Summary input/output instructions	<i>Technical reference manual - RAPID Overview, section RAPID Summary - Input and output signals</i>
Input/Output functionality in general	<i>Technical reference manual - RAPID Overview, section Motion and I/O Principles - I/O principles</i>
Configuration of I/O	<i>Technical reference manual - System parameters</i>
Characteristics of non-value data types	<i>Technical reference manual - RAPID Overview, section Basic Characteristics - Data types</i>

3.73 socketdev - Socket device

Usage

`socketdev` (*socket device*) is used to communicate with other computers on a network or between RAPID task.

Description

The socket device is a handle to a communication link to another computer on a network.

Basic examples

The following example illustrates the data type `socketdev`:

Example 1

```
VAR socketdev socket1;
```

The variable `socket1` is defined and can be used in a `socket` command, e.g. `SocketCreate`.

Limitations

Any number of sockets can be declared but it is only possible to use 32 sockets at the same time.

Characteristics

`socketdev` is a non-value data type.

Related information

For information about	See
Socket communication in general	<i>Application manual - Controller software IRC5</i>
Create a new socket	SocketCreate - Create a new socket on page 745
Characteristics of non-value data types	<i>Technical reference manual - RAPID Overview, section Basic Characteristics - Data Types</i>

3 Data types

3.74 socketstatus - Socket communication status

Socket Messaging

3.74 socketstatus - Socket communication status

Usage

`socketstatus` is used for representing status of the socket communication.

Description

Socket status is fetched with the function `SocketGetStatus` and can be used for program flow control or debugging purposes.

Basic examples

The following example illustrates the data type `socketstatus`:

Example 1

```
VAR socketdev socket1;  
VAR socketstatus state;  
...  
SocketCreate socket1;  
state := SocketGetStatus( socket1 );
```

The socket status `SOCKET_CREATED` will be stored in the variable `state`.

Predefined data

Following constants of type `socketstatus` are predefined:

RAPID constant	Value	The socket is ...
<code>SOCKET_CREATED</code>	1	Created
<code>SOCKET_CONNECTED</code>	2	Client connected to a remote host
<code>SOCKET_BOUND</code>	3	Server bounded to a local address and port
<code>SOCKET_LISTENING</code>	4	Server listening for incoming connections
<code>SOCKET_CLOSED</code>	5	Closed

Characteristics

`socketstatus` is an alias data type for `num` and consequently inherits its characteristics.

Related information

For information about	See
Socket communication in general	<i>Application manual - Controller software IRC5</i>
Get socket status	SocketGetStatus - Get current socket state on page 1462
Data types in general, alias data types	<i>Technical reference manual - RAPID Overview, section Basic Characteristics - Data Types</i>

3.75 speeddata - Speed data

Usage

`speeddata` is used to specify the velocity at which both the robot and the external axes move.

Description

Speed data defines the velocity:

- at which the tool center point moves,
- the reorientation speed of the tool,
- at which linear or rotating external axes move.

When several different types of movement are combined, one of the velocities often limits all movements. The velocity of the other movements will be reduced in such a way that all movements will finish executing at the same time.

The velocity is also restricted by the performance of the robot. This differs, depending on the type of robot and the path of movement.

Basic examples

The following example illustrates the data type `speeddata`:

Example 1

```
VAR speeddata vmedium := [ 1000, 30, 200, 15 ];
```

The speed data `vmedium` is defined with the following velocities:

- 1000 mm/s for the TCP.
- 30 degrees/s for reorientation of the tool.
- 200 mm/s for linear external axes.
- 15 degrees/s for rotating external axes.

```
vmedium.v_tcp := 900;
```

The velocity of the TCP is changed to 900 mm/s.

Predefined data

A number of speed data are already defined in the system.

Predefined speed data to be used for moving the robot and the external axes:

Name	TCP speed	Orientation	Linear ext.axis	Rotating ext.axis
v5	5 mm/s	500°/s	5000 mm/s	1000°/s
v10	10 mm/s	500°/s	5000 mm/s	1000°/s
v20	20 mm/s	500°/s	5000 mm/s	1000°/s
v30	30 mm/s	500°/s	5000 mm/s	1000°/s
v40	40 mm/s	500°/s	5000 mm/s	1000°/s
v50	50 mm/s	500°/s	5000 mm/s	1000°/s
v60	60 mm/s	500°/s	5000 mm/s	1000°/s
v80	80 mm/s	500°/s	5000 mm/s	1000°/s
v100	100 mm/s	500°/s	5000 mm/s	1000°/s

Continues on next page

3 Data types

3.75 speeddata - Speed data

RobotWare Base

Continued

Name	TCP speed	Orientation	Linear ext.axis	Rotating ext.axis
v150	150 mm/s	500 °/s	5000 mm/s	1000 °/s
v200	200 mm/s	500 °/s	5000 mm/s	1000 °/s
v300	300 mm/s	500 °/s	5000 mm/s	1000 °/s
v400	400 mm/s	500 °/s	5000 mm/s	1000 °/s
v500	500 mm/s	500 °/s	5000 mm/s	1000 °/s
v600	600 mm/s	500 °/s	5000 mm/s	1000 °/s
v800	800 mm/s	500 °/s	5000 mm/s	1000 °/s
v1000	1000 mm/s	500 °/s	5000 mm/s	1000 °/s
v1500	1500 mm/s	500 °/s	5000 mm/s	1000 °/s
v2000	2000 mm/s	500 °/s	5000 mm/s	1000 °/s
v2500	2500 mm/s	500 °/s	5000 mm/s	1000 °/s
v3000	3000 mm/s	500 °/s	5000 mm/s	1000 °/s
v4000	4000 mm/s	500 °/s	5000 mm/s	1000 °/s
v5000	5000 mm/s	500 °/s	5000 mm/s	1000 °/s
v6000	6000 mm/s	500 °/s	5000 mm/s	1000 °/s
v7000	7000 mm/s	500 °/s	5000 mm/s	1000 °/s
vmax	i	ii	iii	iv

- i Max. TCP speed for the used robot type and normal practical TCP values, specified by the system parameter *TCP Linear Max Speed (m/s)*. The RAPID function `MaxRobSpeed` returns this value. If extremely large TCP values are used in the tool frame, you can create your own `speeddata` with bigger TCP speed than returned by `MaxRobSpeed` and use `VelSet` to allow larger speed.
- ii Max. reorientation speed for the used robot type, specified by the system parameter *TCP Reorient Max Speed (deg/s)*. The RAPID function `MaxRobReorientSpeed` returns this value.
- iii Max. linear speed for additional axes, specified by the system parameter *Ext. Axis Linear Max Speed (m/s)*. The RAPID function `MaxExtLinearSpeed` returns this value.
- iv Max. rotational speed for additional axes, specified by the system parameter *Ext. Axis Rotational Max Speed (deg/s)*. The RAPID function `MaxExtReorientSpeed` returns this value.

Predefined `speeddata` to be used for moving rotating external axes with instruction `MoveExtJ`.

Name	TCP speed	Orientation	Linear ext.axis	Rotating ext.axis
vrot1	0 mm/s	0 °/s	0 mm/s	1 °/s
vrot2	0 mm/s	0 °/s	0 mm/s	2 °/s
vrot5	0 mm/s	0 °/s	0 mm/s	5 °/s
vrot10	0 mm/s	0 °/s	0 mm/s	10 °/s
vrot20	0 mm/s	0 °/s	0 mm/s	20 °/s
vrot50	0 mm/s	0 °/s	0 mm/s	50 °/s
vrot100	0 mm/s	0 °/s	0 mm/s	100 °/s

Predefined `speeddata` to be used for moving linear external axes with instruction `MoveExtJ`.

Name	TCP speed	Orientation	Linear ext.axis	Rotating ext.axis
vlin10	0 mm/s	0 °/s	10 mm/s	0 °/s
vlin20	0 mm/s	0 °/s	20 mm/s	0 °/s

Continues on next page

Name	TCP speed	Orientation	Linear ext.axis	Rotating ext.axis
vlin50	0 mm/s	0°/s	50 mm/s	0°/s
vlin100	0 mm/s	0°/s	100 mm/s	0°/s
vlin200	0 mm/s	0°/s	200 mm/s	0°/s
vlin500	0 mm/s	0°/s	500 mm/s	0°/s
vlin1000	0 mm/s	0°/s	1000 mm/s	0°/s

Components

v_tcp

velocity tcp

Data type: num

The velocity of the tool center point (TCP) in mm/s.

If a stationary tool or coordinated external axes are used, the velocity is specified relative to the work object.

v_ori

velocity orientation

Data type: num

The reorientation velocity of the TCP expressed in degrees/s.

If a stationary tool or coordinated external axes are used, the velocity is specified relative to the work object.

v_leax

velocity linear external axes

Data type: num

The velocity of linear external axes in mm/s.

v_reax

velocity rotational external axes

Data type: num

The velocity of rotating external axes in degrees/s.

Structure

```
< dataobject of speeddata >
  < v_tcp of num >
  < v_ori of num >
  < v_leax of num >
  < v_reax of num >
```

Limitations

At very slow motion each movement should be short enough to give an interpolation time less than 240 seconds.

Continues on next page

3 Data types

3.75 speeddata - Speed data

RobotWare Base

Continued

Related information

For information about	See
Positioning instructions	<i>Technical reference manual - RAPID Overview, section RAPID Summary - Motion</i>
Motion/Speed in general	<i>Technical reference manual - RAPID Overview, section Motion and I/O principles - Positioning during program execution</i>
Defining maximum velocity	VelSet - Changes the programmed velocity on page 1017
Max. TCP speed for this robot	MaxRobSpeed - Maximum robot speed on page 1363

3.76 stoppointdata - Stop point data

Usage

`stoppointdata` is used to specify how a position is to be terminated, i.e. how close to the programmed position the axes must be before moving towards the next position.

Description

A movement instruction can end either with a zone or a stop point. If the movement ends with a zone, the programmed position is never reached, instead the robot continues smoothly towards the next programmed position. If the movement instruction instead ends with a stop point, the robot must come to a defined stop at the programmed position before the RAPID program moves on to the next instruction. For more information on zones and stop points, see the data type [zonedata - Zone data on page 1811](#).

The data type `stoppointdata` tunes the criteria used for determining when a robot has stopped in a programmed position. It can also be used for determining how long the robot should stand still in a stop point before continuing with the next programmed movement. The last use of `stoppointdata` is to set up a position to be coordinated to a conveyor.

If a movement instruction ends with stop point instead of a zone, then RAPID execution will remain¹ on the movement instruction until the criteria of the of the `stoppointdata` are fulfilled. These criteria are hereafter referred to as the `inpos` (in position) conditions. The `stoppointdata` allows for a tradeoff between cycle time and accuracy/predictability at stopped positions. For example, tightening the `inpos` condition leads to better repeatability of a `CRobT` performed directly after a movement ending with a stop point. Loosening the `inpos` condition will make the RAPID execution faster and thus improve cycle time. When no `stoppointdata` is provided in the movement instruction, the robot specific default values are used. The default values for the `inpos` condition tend to favor cycle time. Note that the used `stoppointdata` will also affect the behavior of instructions like `WaitTime\Inpos`, `WaitUntil\Inpos`, and `WaitRob\Inpos`.

Three types of stop points can be defined by the `stoppointdata`.

- The *in position* type of stop point defines the `inpos` condition as a percentage of the default speed tolerance and position tolerance. The `inpos` condition is satisfied only if both the speed and the position are within respective tolerance at the same time. The *in position* type also uses a minimum and maximum time. The robot waits for at least the minimum time, and at most the maximum time, for the `inpos` condition to be satisfied.
- The *stop time* type of stop point always waits in the stop point for the given time.
- The *follow time* type of stop point is a special type of stop point used to coordinate the robot movement with a conveyor.

¹ An exception is when the switch `\Conc` is used on a movement instruction. In that case RAPID will execute the next instruction immediately.

Continues on next page

3 Data types

3.76 stoppointdata - Stop point data

RobotWare Base

Continued

The `stoppointdata` also determines how the movement shall be synchronized with the RAPID execution. If the movement is synchronized, the RAPID execution waits for an `inpos` event when the robot is in position. If the movement is not synchronized, the RAPID execution gets a `prefetch` event almost a half second before the physical robot reaches the programmed position. When the program execution gets an `inpos` or a `prefetch` event, it continues with the next instruction. When the `prefetch` event arrives, the robot still has a long way to move. When the `inpos` event arrives the robot is close to the programmed position.

For the type `stop time` and `follow time`, the next instruction starts its execution at the same time as the stop time and follow time, respectively, start to count down. But for the type `in position`, the next instruction is started when the convergence criteria is fulfilled.

If use of move instructions with argument `\Conc`, no synchronization at all is done, so the actual move instruction execution will be ready at once.

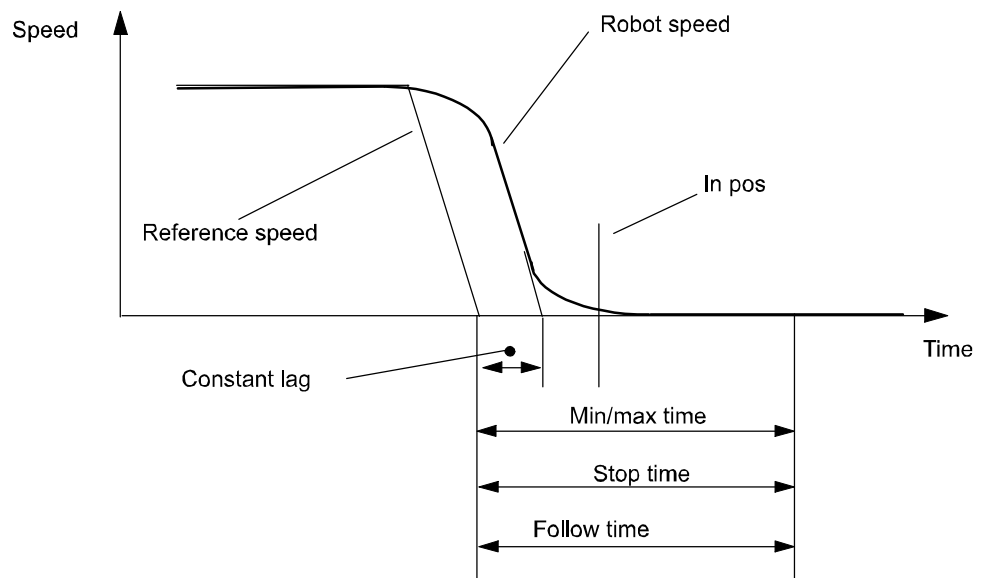

xx0500002374

In the figure above, the termination of the stop points is described. The robot's speed does not decrease linearly. The robot servo is always ahead of the physical robot. It is shown as the constant lag in the figure above. The constant lag is about 0.1 seconds. The timing elements of `stoppointdata` use the reference speed as trigger. When the reference speed is zero the time measurement starts. Therefore the time in the timing elements always include the constant lag. Consequently there is no sense in using values less than the constant lag.

Basic examples

The following examples illustrate the data type `stoppointdata`:

`inpos`

```
VAR stoppointdata my_inpos := [ inpos, TRUE, [ 25, 40, 0.1, 5], 0,
    0, "", 0, 0];
MoveL *, v1000, fine \Inpos:=my_inpos, grip4;
```

Continues on next page

The stop point data `my_inpos` is defined by means of the following characteristics:

- The type of stop point is in-position type, `inpos`.
- The stop point will be synchronized with the RAPID program execution, `TRUE`.
- The stop point distance criteria is 25% of the distance defined for the stop point `fine`, `25`.
- The stop point speed criteria is 40% of the speed defined for the stop point `fine`, `40`.
- The minimum time to wait before convergence is 0.1 s, `0.1`.
- The maximum time to wait on convergence is 5 s, `5`.

The robot moves towards the programmed position until one of the criteria, position or speed, are satisfied.

```
my_inpos.inpos.position := 40;
MoveL *, v1000, fine \Inpos:=my_inpos, grip4;
```

The stop point distance criteria is adjusted to 40%.

stoptime

```
VAR stoppointdata my_stoptime := [ stoptime, FALSE, [ 0, 0, 0, 0 ],
    1.45, 0, "", 0, 0];
MoveL *, v1000, fine \Inpos:=my_stoptime, grip4;
```

The stop point data `my_stoptime` is defined by means of the following characteristics:

- The type of stop point is stop-time type, `stoptime`.
- The stop point will not be synchronized with the RAPID program execution, `FALSE`.
- The wait time in position is 1.45 s, `1.45`.

The robot moves towards the programmed position until the prefetch event arrives. The next RAPID instruction executes. If it is a move-instruction then the robot stops for 1.45 seconds before the next movement starts.

```
my_stoptime.stoptime := 6.66;
MoveL *, v1000, fine \Inpos:=my_stoptime, grip4;
```

The stop point stop time is adjusted to 6.66 seconds. If the next RAPID instruction is a move-instruction, the robot stops for 6.66 s.

followtime

```
VAR stoppointdata my_followtime := [ fllwtime, TRUE, [ 0, 0, 0,
    0 ], 0, 0.5, "", 0, 0];
MoveL *, v1000, z10 \Inpos:=my_followtime, grip6\wobj:=conveyor1;
```

The stop point data `my_followtime` is defined by means of the following characteristics:

- The type of stop point is follow-time type, `fllwtime`.
- The stop point will be synchronized with the RAPID program execution, `TRUE`.
- The stop point follow time is 0.5 s, `0.5`.

The robot will follow the conveyor for 0.5 s before leaving it with the zone 10 mm, `z10`.

```
my_followtime.followtime := 0.4;
```

Continues on next page

3 Data types

3.76 stoppointdata - Stop point data

RobotWare Base

Continued

The stop point follow time is adjusted to 0.4 s.

Predefined data

A number of stop point data are already defined in the system.

In position stop points

Name	progsynch	position	speed	mintime	maxtime	stop-time	follow-time
inpos20	TRUE	20%	20%	0 s	2 s	-	-
inpos50	TRUE	50%	50%	0 s	2 s	-	-
inpos100	TRUE	100%	100%	0 s	2 s	-	-

(inpos100 has same convergence criteria as stop point fine)

Stop time stop points

Name	progsynch	position	speed	mintime	maxtime	stop-time	follow-time
stoptime0_5	FALSE	-	-	-	-	0.5 s	-
stoptime1_0	FALSE	-	-	-	-	1.0 s	-
stoptime1_5	FALSE	-	-	-	-	1.5 s	-

Follow time stop points

Name	progsynch	position	speed	mintime	maxtime	stop-time	follow-time
fillwtime0_5	TRUE	-	-	-	-	-	0.5 s
fillwtime1_0	TRUE	-	-	-	-	-	1.0 s
fillwtime1_5	TRUE	-	-	-	-	-	1.5 s

Components

type

type of stop point

Data type: stoppoint

The following table defines the type of stoppoint.

1 (inpos)	The movement terminates as an in-position type of stop point. Enables the inpos element in stoppointdata. The zone data in the instruction is not used, use fine or z0.
2 (stoptime)	The movement terminates as a stop-time type of stop point. Enables the stoptime element in stoppointdata. The zone data in the instruction is not used, use fine or z0.
3 (followtime)	The movement terminates as a conveyor follow-time type of fine point. The zone data in the instruction is used when the robot leaves the conveyor. Enables the followtime element in stoppointdata.

Continues on next page

Data type `stoppoint` is an alias data type for `num`. It is used to choose the type of stop point and which data elements to use in the `stoppointdata`. Predefined constants are:

Value	Symbolic constant	Comment
1	<code>inpos</code>	In position type number
2	<code>stoptime</code>	Stop time type number
3	<code>flwtime</code>	Follow time type number

`progsynch`

program synchronization

Data type: `bool`

Synchronization with RAPID program execution.

- **TRUE:** The movement is synchronized with RAPID execution. The program does not start to execute the next instruction until the stop point has been reached.
- **FALSE:** The movement is not synchronized with RAPID execution. The program starts the execution of the next instruction before the stop point has been reached.

If use of move instructions with argument `\Conc`, no synchronization at all is done independent of the data in `progsynch`, so the actual move instruction will always be ready at once.

`inpos.position`

position condition for TCP

Data type: `num`

The position condition (the radius) for the TCP in percent of a normal `fine` stop point.

`inpos.speed`

speed condition for TCP

Data type: `num`

The speed condition for the TCP in percent of a normal `fine` stop point.

`inpos.mintime`

minimum wait time

Data type: `num`

The minimum wait time in seconds before in position. Used to make the robot wait at least the specified time in the point. Maximum value is 20.0 seconds.

`inpos.maxtime`

maximum wait time

Data type: `num`

The maximum wait time in seconds for convergence criteria to be satisfied. Used to assure that the robot does not get stuck in the point if the speed and position conditions are set too tight. Maximum value is 20.0 seconds.

Continues on next page

3 Data types

3.76 stoppointdata - Stop point data

RobotWare Base

Continued

stoptime

stop time

Data type: num

The time in seconds, that the TCP stands still in position before starting the next movement. Valid range 0-20 s, resolution 0.001 s.

followtime

follow time

Data type: num

The time in seconds that the TCP follows the conveyor. Valid range is 0-20 s, resolution 0.001 s.

signal

Data type: string

Reserved for future use.

relation

Data type: opnum

Reserved for future use.

checkvalue

Data type: num

Reserved for future use.

Structure

```
< data object of stoppointdata >
  < type of stoppoint >
  < progsynch of bool >
  < inpos of inposdata >
    < position of num >
    < speed of num >
    < mintime of num >
    < maxtime of num >
  < stoptime of num >
  < followtime of num >
  < signal of string >
  < relation of opnum >
  < checkvalue of num >
```

Related information

For information about	See
Positioning instructions	<i>Technical reference manual - RAPID Overview, section RAPID summary - Motion</i>
Movements/Paths in general	<i>Technical reference manual - RAPID Overview, section Motion and I/O principles - Positioning during program execution</i>
Stop or fly-by points	zonedata - Zone data on page 1811

3.77 string - Strings

Usage

`string` is used for character strings.

Description

A character string consists of a number of characters (a maximum of 80) enclosed by quotation marks (""), e.g. "This is a character string".

If the quotation marks are to be included in the string, they must be written twice, e.g. "This string contains a ""character".

If the back slashes are to be included in the string, it must be written twice, e.g. "This string contains a \\ character".

Basic examples

The following example illustrates the data type `string`:

Example 1

```
VAR string text;
...
text := "start welding pipe 1";
TPWrite text;
```

The text `start welding pipe 1` is written on the FlexPendant.

Predefined data

A number of predefined string constants are available in the system and can be used together with string functions. See for example `StrMemb`.

Name	Character set
STR_DIGIT	<digit> ::= 0 1 2 3 4 5 6 7 8 9
STR_UPPER	<upper case letter> ::= A B C D E F G H I J K L M N O P Q R S T U V W X Y Z À Á Â Ã Ä Å Æ Ç È É Ê Ë Ì Í Î Ï Ð Ñ Ò Ó Ô Õ Ö Ø Ù Ú Û Ü Ý Þ ß
STR_LOWER	<lower case letter> ::= a b c d e f g h i j k l m n o p q r s t u v w x y z ß à á â ã ä å æ ç è é ê ë ì í î ï ð ñ ò ó ô õ ö ø ù ú û ü ý þ ÿ
STR_WHITE	<blank character> ::=

The following constants are already defined in the system:

```
CONST string diskhome := "HOME:";
```

Continues on next page

3 Data types

3.77 string - Strings

RobotWare Base

Continued

```
! For old programs from S4C system
CONST string ramldisk := "HOME:";

CONST string disktemp := "TEMP:";

CONST string flp1 := "flp1:";

CONST string stSpace := " ";

CONST string stEmpty := "";
```

Limitations

A string may have 0 to 80 characters; inclusive of extra quotation marks or back slashes.

A string may contain any of the characters specified by ISO 8859-1 (Latin-1) as well as control characters (non-ISO 8859-1 (Latin-1) characters with a numeric code between 0-255).

Related information

For information about	See
Operations using strings	<i>Technical reference manual - RAPID Overview, section Basic characteristics - Expressions</i>
String values	<i>Technical reference manual - RAPID Overview, section Basic characteristics - Basic elements</i>
Instruction using character set	StrMemb - Checks if a character belongs to a set on page 1494

3.78 stringdig - String with only digits

Usage

`stringdig` is used to represent big positive integers in a string with only digits. This data type is introduced because the data type `num` cannot handle positive integers above 8 388 608 with exact representation.

Description

A `stringdig` can only consist of a number of digits 0 ... 9 enclosed by quotation marks (""), e.g. "0123456789".

The data type `stringdig` can handle positive integers up to 4 294 967 295.

Basic examples

The following example illustrates the data type `stringdig`:

Example 1

```
VAR stringdig digits1;
VAR stringdig digits2;
VAR bool flag1;
...
digits1 ="09000000";
digits2 = "9000001";
flag1 := StrDigCmp (digits1, LT, digits2);
```

The data `flag1` will be set to `TRUE` because 09000000 is less than 9000001.

Characteristics

`stringdig` is an alias data type of `string` and consequently inherits most of its characteristics.

Related information

For information about	See
String values	<i>Technical reference manual - RAPID Overview, section Basic characteristics - Basic elements</i>
Strings	string - Strings on page 1761
Numeric values	num - Numeric values on page 1698
Comparison operator	opnum - Comparison operator on page 1701 StrDigCmp - Compare two strings with only digits on page 1483
Compare strings with only digits	StrDigCmp - Compare two strings with only digits on page 1483

3 Data types

3.79 supervtimeouts - Handshake supervision time outs *Continuous Application Platform (CAP)*

3.79 supervtimeouts - Handshake supervision time outs

Usage

`supervtimeouts` is used to define timeout times for handshake supervision in CAP.

`supervtimeouts` is a component of `capdata` and defines the timeout times for the following handshake supervision phases in CAP:

- PRE
- END_PRE and START
- END MAIN and START_POST1
- END_POST1 and START_POST2
- END_POST2

If the parameter is set to 0, there is no timeout.

Components

pre_cond

Data type: num

Timeout time (in seconds) for the PRE phase conditions to be fulfilled.

start_cond

Data type: num

Timeout time (in seconds) for the END_PRE and START phase conditions to be fulfilled.

end_main_cond

Data type: num

Timeout time (in seconds) for the END_MAIN and START_POST1 phase conditions to be fulfilled.

end_post1_cond

Data type: num

Timeout time (in seconds) for the END_POST1 and START_POST2 phase conditions to be fulfilled.

end_post2_cond

Data type: num

Timeout time (in seconds) for the END_POST2 phase conditions to be fulfilled.

Syntax

```
< data object of supervtimeouts >  
  < pre_cond of num >  
  < start_cond of num >  
  < end_main_cond of num >  
  < end_post1_cond of num >  
  < end_post2_cond of num >
```

Continues on next page

Related information

	Described in:
capdata data type	capdata - CAP data on page 1614
<i>Continuous Application Platform</i>	<i>Application manual - Continuous Application Platform</i>

3 Data types

3.80 switch - Optional parameters

RobotWare Base

3.80 switch - Optional parameters

Usage

`switch` is used for optional parameters.

Description

The special type, `switch` may (only) be assigned to optional parameters and provides a means to use switch arguments, i.e. arguments that are only specified by names (not values). A value can not be transmitted to a switch parameter. The only way to use a switch parameter is to check for its presence using the predefined function `Present`.

Basic examples

The following example illustrates the data type `switch`:

Example 1

```
PROC my_routine(\switch on | switch off)
....
IF Present (off) THEN
....
ENDIF
ENDPROC
```

Depending on what arguments the caller of `my_routine` uses, the program flow can be controlled.

Characteristics

`switch` is a non-value data type and can not be used in value-orientated operations.

Related information

For information about	See
Parameters	<i>Technical reference manual - RAPID Overview, section Basic characteristics - Routines.</i>
How to check if an optional parameter is present	Present - Tests if an optional parameter is used on page 1416

3.81 symnum - Symbolic number

Usage

`symnum` (*Symbolic Number*) is used to represent an integer with a symbolic constant.

Description

A `symnum` constant is intended to be used when checking the return value from the functions `OpMode` and `RunMode`.

Basic examples

The following example illustrates the data type `symnum`:

Example 1

```
IF RunMode() = RUN_CONT_CYCLE THEN
  ..
ELSE
  ..
ENDIF
```

Predefined data

The following symbolic constants of the data type `symnum` are predefined and can be used when checking return values from the functions `OpMode` and `RunMode`.

Value	Symbolic constant	Comment
0	RUN_UNDEF	Undefined running mode
1	RUN_CONT_CYCLE	Continuous or cycle running mode
2	RUN_INSTR_FWD	Instruction forward running mode
3	RUN_INSTR_BWD	Instruction backward running mode
4	RUN_SIM	Simulated running mode
5	RUN_STEP_MOVE	Move instructions in forward running mode and logical instructions in continuous running mode

Value	Symbolic constant	Comment
0	OP_UNDEF	Undefined operating mode
1	OP_AUTO	Automatic operating mode
2	OP_MAN_PROG	Manual operating mode max. 250 mm/s
3	OP_MAN_TEST	Manual operating mode full speed, 100%

Characteristics

`Symnum` is an alias data type for `num` and consequently inherits its characteristics.

Related information

For information about	See
Data types in general, alias data types	<i>Technical reference manual - RAPID Overview, section Basic characteristics - Data types</i>

3 Data types

3.82 syncident - Identity for synchronization point

Multitasking

3.82 syncident - Identity for synchronization point

Usage

`syncident` (*synchronization identity*) is used to specify the name of a synchronization point. The name of the synchronization point will be the name (identity) of the declared data of type `syncident`.

Description

`syncident` is used to identify a point in the program where the actual program task will wait for cooperate program tasks to reach the same synchronization point. The data name (identity) of the type `syncident` must be the same in all cooperative program tasks.

Data type `syncident` is used in the instructions `WaitSyncTask`, `SyncMoveOn`, and `SyncMoveOff`.

Basic examples

The following example illustrates the data type `syncident`:

Example 1

Program example in program task `T_ROB1`

```
PERS tasks task_list{3} := [ ["T_STN1"], ["T_ROB1"], ["T_ROB2"] ];  
VAR syncident sync1;
```

```
WaitSyncTask sync1, task_list;
```

At execution of instruction `WaitSyncTask` in the program task `T_ROB1`, the execution in that program task will wait until the other program tasks `T_STN1` and `T_ROB2` have reached their corresponding `WaitSyncTask` with the same synchronization (meeting) point `sync1`.

Structure

`syncident` is a non-value data type.

Related information

For information about	See
Specify cooperated program tasks	tasks - RAPID program tasks on page 1772
Wait for synchronization point with other tasks	WaitSyncTask - Wait at synchronization point for other program tasks on page 1070
Start coordinated synchronized movements	SyncMoveOn - Start coordinated synchronized movements on page 842
End coordinated synchronized movements	SyncMoveOff - End coordinated synchronized movements on page 836

3.83 System data - Current RAPID system data settings

Usage

System data mirrors the current settings of RAPID system data such as current model motion settings, current error recovery number `ERRNO`, current interrupt number `INTNO`, etc.

These data can be accessed and read by the program. It can be used to read the current status, e.g. the current program displacement.

C_MOTSET

The variable `C_MOTSET` of data type `motsetdata` mirrors the current motion settings:

Description	Data type	Changed by	Also see
Current motion settings, i.e.:	<code>motsetdata</code>	Instructions	motsetdata - Motion settings data on page 1692
Velocity override and max velocity		<code>VelSet</code>	VelSet - Changes the programmed velocity on page 1017
Acceleration override		<code>AccSet</code>	AccSet - Reduces the acceleration on page 25
Movements around singular points		<code>SingArea</code>	SingArea - Defines interpolation around singular points on page 729
Linear configuration control Joint configuration control		<code>ConfL</code> <code>ConfJ</code>	ConfL - Monitors the configuration during linear movement on page 157 ConfJ - Controls the configuration during joint movement on page 155
Path resolution		<code>PathResol</code>	PathResol - Override path resolution on page 537
Tuning motion supervision		<code>MotionSup</code>	MotionSup - Deactivates/Activates motion supervision on page 392
Reduction of TCP acceleration/deceleration along the movement path		<code>PathAccLim</code>	PathAccLim - Reduce TCP acceleration along the path on page 512
Modification of the tool orientation during circle interpolation		<code>CirPathMode</code>	CirPathMode - Tool reorientation during circle path on page 132
Reduction of payload acceleration in world coordinate system		<code>WorldAccLim</code>	WorldAccLim - Control acceleration in world coordinate system on page 1093

C_PROGDISP

The variable `C_PROGDISP` of data type `progdisp` mirrors the current program displacement and external axes offset:

Description	Data type	Changed by	Also see
Current program displacement for robot axes	<code>progdisp</code>	Instructions:	progdisp - Program displacement on page 1719

Continues on next page

3 Data types

3.83 System data - Current RAPID system data settings

RobotWare Base

Continued

Description	Data type	Changed by	Also see
		PDispSet	PDispSet - Activates program displacement using known frame on page 545
		PDispOn	PDispOn - Activates program displacement on page 540
		PDispOff	PDispOff - Deactivates program displacement on page 539
Current external axes offset		EOffsSet	EOffsSet - Activates an offset for additional axes using known values on page 193
		EOffsOn	EOffsOn - Activates an offset for additional axes on page 191
		EOffsOff	EOffsOff - Deactivates an offset for additional axes on page 190

ERRNO

The variable `ERRNO` of data type `errnum` mirrors the current error recovery number:

Description	Data type	Changed by	Also see
The latest error that occurred	<code>errnum</code>	The system	Technical reference manual - RAPID Overview, section RAPID summary - Error recovery intnum - Interrupt identity on page 1675

INTNO

The variable `INTNO` of data type `intnum` mirrors the current interrupt number:

Description	Data type	Changed by	Also see
The latest interrupt that occurred	<code>intnum</code>	The system	Technical reference manual - RAPID Overview, section RAPID summary - Interrupts intnum - Interrupt identity on page 1675

ROB_ID

The variable `ROB_ID` of data type `mecunit` contains a reference to the TCP-robot (if any) in the actual program task.

Description	Data type	Changed by	Also see
Reference to the robot (if any) in the actual program task. Always check before use with <code>TaskRunRob ()</code>	<code>mecunit</code>	The system	mecunit - Mechanical unit on page 1690

3.84 taskid - Task identification

Usage

`taskid` is used to identify available program tasks in the system.

The names of the program tasks are defined in the system parameters and, consequently, must not be defined in the program.

Description

Data of the type `taskid` only contains a reference to the program task.

Predefined data

The program tasks defined in the system parameters can always be accessed from the program (installed data).

For all program tasks in the system, predefined variables of the data type `taskid` will be available. The variable identity will be "taskname"+"Id", e.g. for the `T_ROB1` task the variable identity will be `T_ROB1Id`, `T_ROB2 - T_ROB2Id` etc.

Limitations

Data of the type `taskid` must not be defined in the program. The data type can, on the other hand, be used as a parameter when declaring a routine.

Characteristics

`taskid` is a non-value data type. This means that data of this type does not permit value-oriented operations.

Related information

For information about	See
Saving program modules	Save - Save a program module on page 650
Configuration of program tasks	<i>Technical reference manual - System parameters</i>
Characteristics of non-value data types	<i>Technical reference manual - RAPID Overview, section Basic characteristics - Data types</i>

3 Data types

3.85 tasks - RAPID program tasks

Multitasking

3.85 tasks - RAPID program tasks

Usage

`tasks` is used to specify several RAPID program tasks.

Description

To specify several RAPID program tasks, the name of each task can be given as a string. An array of data type `tasks` can then hold all the task names.

This task list can then be used in the instructions `WaitSyncTask` and `SyncMoveOn`.



Note

The instructions above demand that the data is defined as system global `PERS` variables available in all the cooperated tasks.

Basic examples

The following example illustrates the data type `tasks`:

Example 1

Program example in program task `T_ROB1`

```
PERS tasks task_list{3} := [ ["T_STN1"], ["T_ROB1"], ["T_ROB2"] ];  
VAR syncident sync1;
```

```
WaitSyncTask sync1, task_list;
```

At execution of instruction `WaitSyncTask` in the program task `T_ROB1`, the execution in that program task will wait until all the other program tasks `T_STN1` and `T_ROB2` have reached their corresponding `WaitSyncTask` with the same synchronization (meeting) point `sync1`.

Components

The data type has the following components.

`taskname`

Data type: `string`

The name of a RAPID program task specified in a string.

Structure

```
<dataobject of tasks>  
  <taskname of string>
```

Related information

For information about	See
Identity for synchronization point	syncident - Identity for synchronization point on page 1768
Wait for synchronization point with other tasks	WaitSyncTask - Wait at synchronization point for other program tasks on page 1070
Start coordinated synchronized movements	SyncMoveOn - Start coordinated synchronized movements on page 842

Continues on next page

For information about	See
End coordinated synchronized movements	SyncMoveOff - End coordinated synchronized movements on page 836

3 Data types

3.86 testsignal - Test signal

RobotWare Base

3.86 testsignal - Test signal

Usage

The data type `testsignal` is used when a test of the robot motion system is performed.

Description

A number of predefined test signals are available in the robot system. The `testsignal` data type is available in order to simplify programming of instruction `TestSignDefine`.

Basic examples

The following examples illustrate the data type `testsignal`:

Example 1

```
TestSignDefine 2, speed, Orbit, 2, 0;
```

The predefined constant `speed` is used to read the actual speed of axis 2 on the manipulator `orbit`.

Example 2

```
TestSignDefine 4, 4001, ROB_1, 2, 0;
```

The test signal `speed` is used to read the actual speed of axis 2 on the robot.

Predefined data

The following test signals are available for additional axes and are predefined in the system. All data is in SI units and measured on the motor side of the axis.

Symbolic constant	Value	Unit
<code>testsignal_speed</code>	6	rad/s
<code>testsignal_torque_ref</code>	9	Nm
<code>testsignal_resolver_angle</code>	1	rad
<code>testsignal_speed_ref</code>	4	rad/s
<code>dig_input1</code>	102	0 or 1
<code>dig_input2</code>	103	0 or 1

The following test signals are available for both robot and additional axes and are predefined in the system. All data is measured on the arm side of the axis.

Test signal	Value	Unit
Position	4000	degrees or mm ⁱ
Speed	4001	degrees/second or mm/s ⁱ
Torque	4002	Nm
External torque ⁱⁱ	4003	Nm

ⁱ The unit depends on if the axis is rotational or linear.

ⁱⁱ Returns an estimated externally applied torque (by contact with the environment). On an additional axis External torque might not be valid.

Continues on next page

Characteristics

`testsignal` is an alias data type for `num` and consequently inherits its characteristics.

Related information

For information about	See
Define test signal	TestSignDefine - Define test signal on page 860
Read test signal	TestSignRead - Read test signal value on page 1519
Reset test signals	TestSignReset - Reset all test signal definitions on page 862

3 Data types

3.87 tooldata - Tool data *RobotWare Base*

3.87 tooldata - Tool data

Usage

`tooldata` is used to describe the characteristics of a tool, for example, a welding gun or a gripper. These characteristics are position and orientation of the tool center point (TCP) and the physical characteristics of the tool load.

If the tool is fixed in space (a stationary tool), the tool data firstly defines position and orientation of this very tool in space, TCP. Then it describes the load of the gripper moved by the robot.

Description

Tool data affects robot movements in the following ways:

- The tool center point (TCP) refers to a point that will satisfy the specified path and velocity performance. If the tool is reorientated or if coordinated external axes are used, only this point will follow the desired path at the programmed velocity.
- If a stationary tool is used, the programmed speed and path will relate to the work object held by the robot.
- Programmed positions refer to the position of the current TCP and the orientation in relation to the tool coordinate system. This means that if, for example, a tool is replaced because it is damaged, the old program can still be used if the tool coordinate system is redefined.

Tool data is also used when jogging the robot to:

- Define the TCP which is not moving when the tool is reorientated.
- Define the tool coordinate system in order to facilitate moving in or rotating in the tool coordinate directions.



WARNING

It is important to always define the actual tool load and, when used, the payload of the robot (for example, a gripped part). Incorrect definitions of load data can result in overloading of the robot mechanical structure. There is also a risk that the speed in manual reduced speed mode can be exceeded.

When incorrect load data is specified, it can often lead to the following consequences:

- The robot may not use its maximum capacity.
- Impaired path accuracy including a risk of overshooting.
- Risk of overloading the mechanical structure.

The controller continuously monitors the load and writes an event log if the load is higher than expected. This event log is saved and logged in the controller memory.

Continues on next page

Basic examples

The following examples illustrate the data type `tooldata`:

Example 1

```
PERS tooldata gripper := [ TRUE, [[97.4, 0, 223.1], [0.924, 0,
                                0.383 ,0]], [5, [23, 0, 75], [1, 0, 0, 0], 0, 0, 0]];
```

The tool is described using the following values:

- The robot is holding the tool.
- The TCP is located at a point 223.1 mm straight out from the mounting flange and 97.4 mm along the X-axis of the wrist coordinate system.
- The X' and Z' directions of the tool are rotated 45° in relation to Y direction in the wrist coordinate system.
- The tool mass is 5 kg.
- The center of gravity is located at a point 75 mm straight out from mounting flange and 23 mm along the X-axis of the wrist coordinate system.
- The load can be considered a point mass, that is, without any moment of inertia.

Example 2

```
gripper.tframe.trans.z := 225.2;
```

The TCP of the tool, `gripper`, is adjusted to 225.2 in the z-direction.

Predefined data

The tool `tool0` defines the wrist coordinate system, with the origin being the center of the mounting flange. `tool0` can always be accessed from the program, but can never be changed (it is stored in system module `BASE`).

```
PERS tooldata tool0 := [ TRUE, [ [0, 0, 0], [1, 0, 0 ,0] ], [0.001,
                                [0, 0, 0.001], [1, 0, 0, 0], 0, 0, 0] ];
```

Components

`robhold`

robot hold

Data type: `bool`

Defines whether or not the robot is holding the tool:

- `TRUE`: The robot is holding the tool.
- `FALSE`: The robot is not holding the tool, that is, a stationary tool.

`tframe`

tool frame

Data type: `pose`

The tool coordinate system, that is:

- The position of the TCP (x, y and z) in mm, expressed in the wrist coordinate system (`tool0`) (see figure below).
- The orientation of the tool coordinate system, expressed in the wrist coordinate system (see figure below).

Continues on next page

3 Data types

3.87 tooldata - Tool data

RobotWare Base

Continued

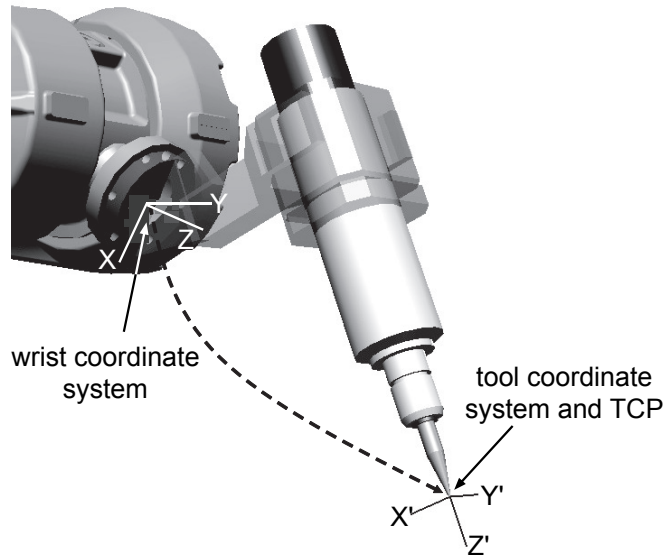

xx110000517

Figure 3.3: Robot held tool



Note

If a stationary tool is used, the tool frame is defined in relation to the world coordinate system.

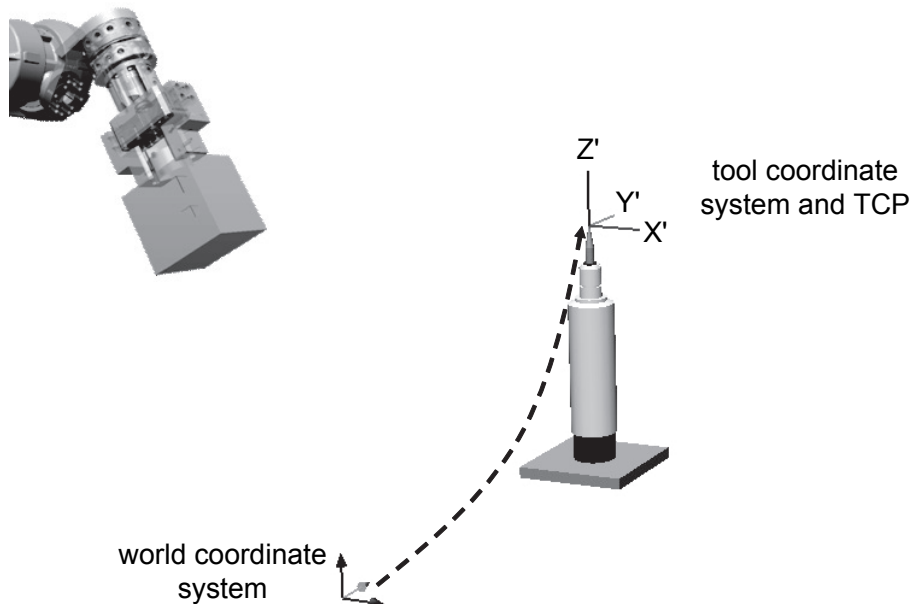

xx110000518

Figure 3.4: Stationary tool

Continues on next page

tload

tool load

Data type: loaddata

**Note**

This data is used both for robot held tool and for stationary tool. For a robot held tool the data describes the tool load. For a stationary tool the data describes the load of the robot held gripper.

Robot held tool:

The load of the tool, that is:

- The mass (weight) of the tool in kg.
- The center of gravity of the tool load (x, y and z) in mm, expressed in the wrist coordinate system
- The orientation of the principal inertial axes of moment of the tool expressed in the wrist coordinate system
- The moments of inertia around inertial axes of moment in kgm^2 . If all inertial components are defined as being 0 kgm^2 , the tool is handled as a point mass.

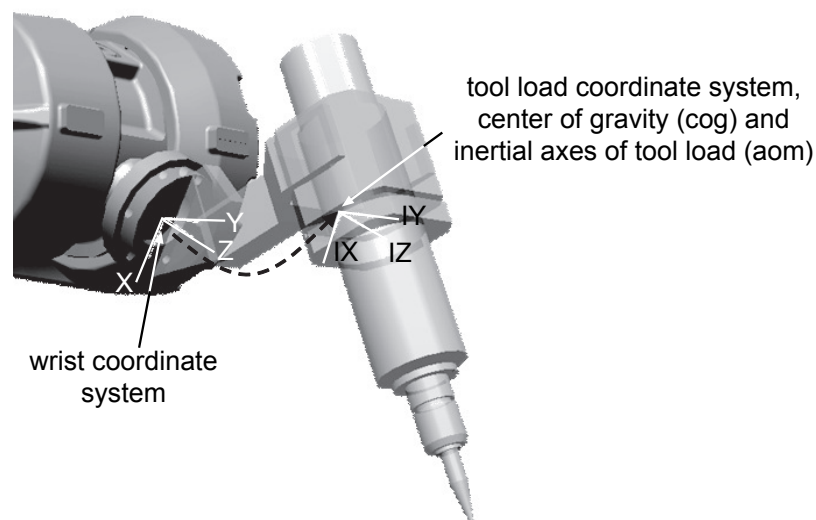

xx110000519

Stationary tool:

The load of the gripper holding the work object:

- The mass (weight) of the moved gripper in kg
- The center of gravity of moved gripper (x, y and z) in mm, expressed in the wrist coordinate system
- The orientation of the principal inertial axes of moment of the moved gripper expressed in the wrist coordinate system

Continues on next page

3 Data types

3.87 tooldata - Tool data

RobotWare Base

Continued

- The moments of inertia around inertial axes of moment in kgm^2 . If all inertial components are defined as being 0 kgm^2 , the gripper is handled as a point mass.

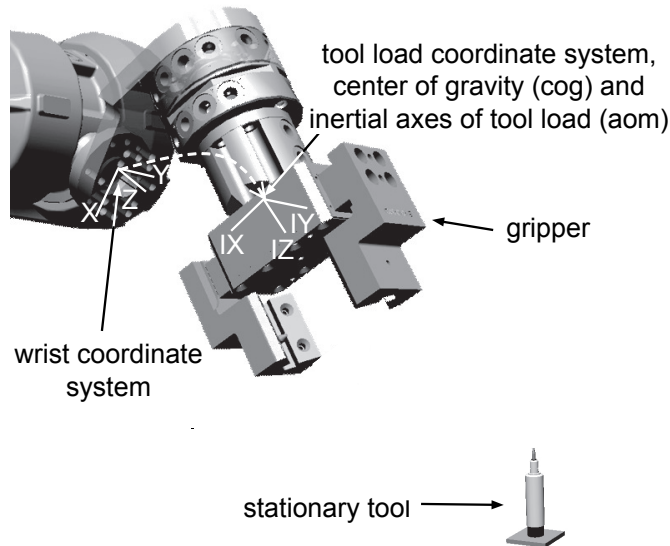

xx1100000520



Note

Only the load of the tool/gripper is to be specified in `tooldata`. The payload handled by a gripper is connected and disconnected by the instruction `GripLoad` and defined with a `loaddata`.

Instead of using the instruction `GripLoad` it is possible to define and use different `tooldata` for *gripper with gripped workpiece* and *gripper without workpiece*.

Summary

Position and orientation of TCP in `tooldata` are defined in the wrist coordinate system for a robot held tool.

Position and orientation of TCP in `tooldata` are defined in the world coordinate system for a stationary tool.

The `loaddata` part in `tooldata` is in all cases related to the wrist coordinate system, regardless of the fact whether a robot held tool (to describe the tool) or a stationary tool (to describe the gripper) is used.

Structure

```
< dataobject of tooldata >  
  < robhold of bool >  
  < tframe of pose >  
    < trans of pos >  
      < x of num >  
      < y of num >  
      < z of num >
```

Continues on next page

```

    < rot of orient >
      < q1 of num >
      < q2 of num >
      < q3 of num >
      < q4 of num >
    < tload of loaddata >
      < mass of num >
      < cog of pos >
      < x of num >
      < y of num >
      < z of num >
      < aom of orient >
      < q1 of num >
      < q2 of num >
      < q3 of num >
      < q4 of num >
      < ix of num >
      < iy of num >
      < iz of num >
  
```

Limitations

The tool data should be defined as a persistent variable (`PERS`) and should not be defined within a routine. The current values are then saved when the program is saved and are retrieved on loading.

Arguments of the type tool data in any motion instruction should only be an entire persistent (not array element or record component).

Related information

For information about	See
Positioning instructions	<i>Technical reference manual - RAPID Overview, section RAPID summary - Motion</i>
Coordinate systems	<i>Technical reference manual - RAPID Overview, section Motion and I/O Principles - Coordinate systems</i>
Define payload for robots	GripLoad - Defines the payload for a robot on page 243
Definition of load data	loaddata - Load data on page 1682
Definition of work object data	wobjdata - Work object data on page 1803

3 Data types

3.88 tnum - FlexPendant window number

RobotWare Base

3.88 tnum - FlexPendant window number

Usage

tnum is used to represent the FlexPendant window number with a symbolic constant.

Description

A tnum constant is intended to be used in instruction TPShow.

Basic examples

The following example illustrates the data type tnum:

Example 1

```
TPShow TP_LATEST;
```

The last used FlexPendant Window before the current FlexPendant window will be active after execution of this instruction.

Predefined data

The following symbolic constant of the data type tnum is predefined and can be used in instruction TPShow:

Value	Symbolic constant	Comment
2	TP_LATEST	Latest used FlexPendant window

Characteristics

tnum is an alias data type for num and consequently inherits its characteristics.

Related information

Information about	See
Data types in general, alias data types	<i>Technical reference manual - RAPID Overview, section Basic Characteristics - Data Types</i>
Communicating using the FlexPendant	<i>Technical reference manual - RAPID Overview, section RAPID Summary - Communication</i>
Switch window on the FlexPendant	TPShow - Switch window on the FlexPendant on page 879

3.89 trapdata - Interrupt data for current trap routine

Usage

trapdata (*trap data*) is used to contain the interrupt data that caused the current trap routine to be executed.

To be used in trap routines generated by instruction `IError`, before use of the instruction `ReadErrData`.

Description

Data of the type `trapdata` represents internal information related to the interrupt that caused the current trap routine to be executed. Its content depends on the type of interrupt.

Basic examples

The following example illustrates the data type `trapdata`:

Example 1

```

VAR errdomain err_domain;
VAR num err_number;
VAR errtype err_type;
VAR trapdata err_data;
...
TRAP trap_err
  GetTrapData err_data;
  ReadErrData err_data, err_domain, err_number, err_type;
ENDTRAP

```

When an error is trapped to the trap routine `trap_err`, the error domain, the error number, and the error type are saved into appropriate non-value variables of type `trapdata`.

Characteristics

`trapdata` is a non-value data type.

Related information

For information about	See
Summary of interrupts	<i>Technical reference manual - RAPID Overview</i>
More information on interrupt management	<i>Technical reference manual - RAPID Overview</i>
Non value data types	<i>Technical reference manual - RAPID Overview</i>
Orders an interrupt on errors	IError - Orders an interrupt on errors on page 255
Get interrupt data for current trap	GetTrapData - Get interrupt data for current trap routine on page 239
Gets information about an error	ReadErrData - Gets information about an error on page 590

Continues on next page

3 Data types

3.89 trapdata - Interrupt data for current trap routine

RobotWare Base

Continued

For information about	See
<i>Advanced RAPID</i>	<i>Product specification - Controller software IRC5</i>

3.90 triggdata - Positioning events, trigg

Usage

`triggdata` is used to store data about a positioning event during a robot movement.

A positioning event can take the form of setting an output signal or running an interrupt routine at a specific position along the movement path of the robot.

Description

To define the conditions for the respective measures at a positioning event, variables of the type `triggdata` are used. The data contents of the variable are formed in the program using one of the instructions `TriggIO`, `TriggEquip`, `TriggCheckIO`, `TriggInt`, `TriggSpeed` or `TriggRampAO` and are used by one of the instructions `TriggL`, `TriggC` or `TriggJ`.

Basic examples

The following example illustrates the data type `triggdata` :

Example 1

```
VAR triggdata gunoff;
TriggIO gunoff, 0,5 \DOP:=gun, 0;
TriggL p1, v500, gunoff, fine, gun1;
```

The digital output signal `gun` is set to the value 0 when the TCP is at a position 0,5 mm before the point `p1`.

Characteristics

`triggdata` is a non-value data type.

Related information

For information about	See
Definition of triggs	TriggIO - Define a fixed position or time I/O event near a stop point on page 921 TriggEquip - Define a fixed position and time I/O event on the path on page 910 TriggCheckIO - Defines I/O check at a fixed position on page 900 TriggInt - Defines a position related interrupt on page 916
Use of triggs	TriggL - Linear robot movements with events on page 935 TriggC - Circular robot movement with events on page 891 TriggJ - Axis-wise robot movements with events on page 927
Characteristics of non-value data types	Technical reference manual - RAPID Overview, section Basic characteristics - Data types

3 Data types

3.91 triggios - Positioning events, trigg *RobotWare Base*

3.91 triggios - Positioning events, trigg

Usage

`triggios` is used to store data about a positioning event during a robot movement. When the positioning event is distributed at a specific position on the path, an output signal is set to a specified value.

Description

`triggios` is used to define conditions and actions for setting a digital output signal, a group of digital output signals or an analog output signal at a fixed position along the robot's movement path.

Examples

The following example illustrates the data type `triggios`:

Example 1

```
VAR triggios gunon{1};

gunon{1}.used:=TRUE;
gunon{1}.distance:=3;
gunon{1}.start:=TRUE;
gunon{1}.signalname:="gun";
gunon{1}.equiplag:=0;
gunon{1}.setvalue:=1;

MoveJ p1, v500, z50, gun1;
TriggLIOS p2, v500, \TriggData1:=gunon, z50, gun1;
MoveL p3, v500, z50, gun1;
```

The signal `gun` is set when the TCP is 3 mm after point `p1`.

Components

`used`

Data type: `bool`

Defines whether or not the array element should be used or not.

`distance`

Data type: `num`

Defines the position on the path where the I/O event shall occur. Specified as the distance in mm (positive value) from the end point of the movement path if component `start` is set to `FALSE`.

`start`

Data type: `bool`

Set to `TRUE` when the distance starts at the movement start point instead of the end point.

`equiplag`

Equipment Lag

Continues on next page

Data type: num

Specify the lag for the external equipment in s.

For compensation of external equipment lag, use a positive argument value. Positive value means that the I/O signal is set by the robot system at a specified time before the TCP physically reaches the specified distance in relation to the movement start or end point.

Negative value means that the I/O signal is set by the robot system at a specified time after that the TCP has physically passed the specified distance in relation to the movement start or end point.

The figure shows use of component `equiplag`.

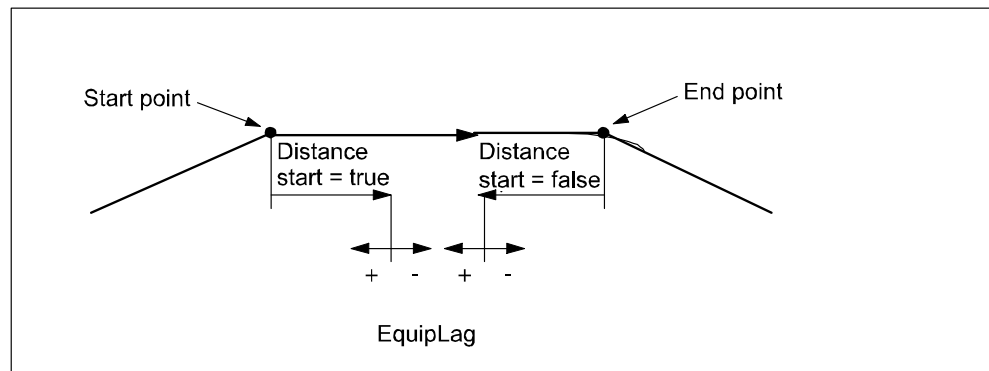

xx080000173

signalname

Data type: string

The name of the signal that shall be changed. It have to be a digital output signal, group of digital output signals or an analog output signal.

setvalue

Data type: num

Desired value of output signal (within the allowed range for the current signal).

xxx

Data type: num

Component is not used right now. Added to be able to add functionality in future releases, and still be able to be compatible.

Structure

```

<dataobject of triggios>
  <used of bool>
  <distance of num>
  <start of bool>
  <equiplag of num>
  <signalname of string>
  <setvalue of num>
  <xxx of num>

```

Continues on next page

3 Data types

3.91 triggios - Positioning events, trigg

RobotWare Base

Continued

Related information

For information about	See
Positioning events, trigg	triggiosdnum - Positioning events, trigg on page 1789
Linear robot movements with I/O events	TriggLIOs - Linear robot movements with I/O events on page 950

3.92 triggiosdnum - Positioning events, trigg

Usage

`triggiosdnum` is used to store data about a positioning event during a robot movement. When the positioning event is distributed at a specific position on the path, an output signal is set to a specified value.

Description

`triggiosdnum` is used to define conditions and actions for setting a digital output signal, a group of digital output signals or an analog output signal at a fixed position along the robot's movement path.

Examples

The following example illustrates the data type `triggiosdnum`:

Example 1

```
VAR triggiosdnum gunon{1};

gunon{1}.used:=TRUE;
gunon{1}.distance:=3;
gunon{1}.start:=TRUE;
gunon{1}.signalname:="go_gun";
gunon{1}.equiplag:=0;
gunon{1}.setvalue:=123456789;

MoveJ p1, v500, z50, gun1;
TriggLIOS p2, v500, \TriggData3:=gunon, z50, gun1;
MoveL p3, v500, z50, gun1;
```

The signal `go_gun` is set when the TCP is 3 mm after point `p1`.

Components

`used`

Data type: `bool`

Defines whether or not the array element should be used or not.

`distance`

Data type: `num`

Defines the position on the path where the I/O event shall occur. Specified as the distance in mm (positive value) from the end point of the movement path if component `start` is set to `FALSE`.

`start`

Data type: `bool`

Set to `TRUE` when the distance starts at the movement start point instead of the end point.

`equiplag`

Equipment Lag

Continues on next page

3 Data types

3.92 triggiosdnum - Positioning events, trigg

RobotWare Base

Continued

Data type: num

Specifies the lag for the external equipment in s.

For compensation of external equipment lag, use a positive argument value. Positive value means that the I/O signal is set by the robot system at a specified time before the TCP physically reaches the specified distance in relation to the movement start or end point.

Negative value means that the I/O signal is set by the robot system at a specified time after the TCP has physically passed the specified distance in relation to the movement start or end point.

signalname

Data type: string

The name of the signal that shall be changed. It has to be a digital output signal, group of digital output signals or an analog output signal.

setvalue

Data type: dnum

Desired value of output signal (within the allowed range for the current signal).

xxx

Data type: num

Component is not used right now. Added to be able to add functionality in future releases, and still be able to be compatible.

Structure

```
<dataobject of triggiosdnum>
  <used of bool>
  <distance of num>
  <start of bool>
  <equiplag of num>
  <signalname of string>
  <setvalue of dnum>
  <xxx of num>
```

Related information

For information about	See
Positioning events, trigg	triggios - Positioning events, trigg on page 1786
Linear robot movements with I/O events	TriggLIOs - Linear robot movements with I/O events on page 950

3.93 triggmode - Trigg action mode

Usage

`triggmode` is used to specify different action modes when defining triggers.

Description

A `triggmode` constant is intended to be used to define the mode for instructions used for definition of triggers.

Basic examples

The following examples illustrate the data type `triggmode`:

Example 1

```
CONNECT intno1 WITH trap1;
TriggInt trigg1, Distance:=17, intno1 \Inhib:=inhibit
      \Mode:=TRIGG_MODE1;
TriggL p1, v500, trigg1, z50, gun1;
```

The interrupt routine `trap1` is run when the TCP is at a position 17 mm before the point `p1` if persistent variable `inhibit` flag is `TRUE` (mode `TRIGG_MODE1` invert the value read from `inhibit` flag).

Example 2

```
TriggEquip trigg1, 17, 0 \GOp:=go1, SetValue:=5 \Inhib:=inhibit
      \Mode:=TRIGG_MODE2;
TriggL p1, v500, trigg1, z50, gun1;
```

If the persistent flag `inhibit` is `FALSE` when the TCP is at a position 17 mm before the point `p1`, the I/O signal `go1` is set to the value specified in `SetValue`. If persistent variable `inhibit` is `TRUE`, no action at all is performed (keep value of I/O signal `go1`).

Example 3

```
TriggEquip trigg1, 17, 0 \GOp:=go1, SetValue:=0 \Inhib:=inhibit
      \InhibSetValue:=setDnum \Mode:=TRIGG_MODE3;
TriggL p1, v500, trigg1, z50, gun1;
```

If the persistent flag `inhibit` is `TRUE` when the TCP is at a position 17 mm before the point `p1`, the I/O signal `go1` is set to the value read from the `dnum` persistent variable `setDnum`. If `inhibit` is `FALSE`, no action at all is performed (keep value of I/O signal `go1`).

Example 4

```
TriggEquip trigg1, 17, 0 \GOp:=go1, SetValue:=5 \Inhib:=inhibit
      \Mode:=TRIGG_MODE3;
TriggL p1, v500, trigg1, z50, gun1;
```

If the persistent flag `inhibit` is `TRUE` when the TCP is at a position 17 mm before the point `p1`, the I/O signal `go1` is set to the value specified in `SetValue` (5 in this example). If `inhibit` is `FALSE`, no action at all is performed (keep value of I/O signal `go1`).

Continues on next page

3 Data types

3.93 triggmode - Trigg action mode

RobotWare Base

Continued

Predefined data

The following symbolic constants of the data type `triggmode` are predefined and can be used to specify different action modes when defining triggers.

Value	Symbolic constant	Comment
1	TRIGG_MODE1	<p>Can be used by instructions <code>TriggCheckIO</code>, <code>TriggEquip</code>, <code>TriggIO</code>, <code>TriggInt</code>, <code>TriggSpeed</code>, and <code>TriggRampAO</code>.</p> <p>Invert the value read from persistent variable used in optional argument <code>Inhib</code>.</p>
2	TRIGG_MODE2	<p>Can be used by instructions <code>TriggEquip</code>, <code>TriggIO</code>, <code>TriggSpeed</code>, and <code>TriggRampAO</code> if using optional argument <code>Inhib</code>.</p> <p>If the actual value of the specified flag used in <code>Inhib</code> is <code>TRUE</code> at the position-time for setting the I/O signal, then the specified I/O signal will not be updated (no action).</p>
3	TRIGG_MODE3	<p>Mode can only be used together with optional argument <code>Inhib</code> in instructions <code>TriggEquip</code> and <code>TriggIO</code>.</p> <p>If the actual value of the specified flag used in <code>Inhib</code> is <code>FALSE</code>, the I/O signal is not updated (no action).</p> <p>If used only with <code>Inhib</code> and the specified flag used in <code>Inhib</code> is <code>TRUE</code> at the position, the I/O signal is set to the value specified in argument <code>SetValue</code> or <code>SetDvalue</code>.</p> <p>If used with both <code>Inhib</code> and <code>InhibSetValue</code>: The arguments <code>SetValue</code> and <code>SetDvalue</code> are not considered at all. If the actual value of the specified flag used in <code>Inhib</code> is <code>TRUE</code>, then the I/O signal is set to the value that the persistent variable used in optional argument <code>InhibSetValue</code> has at the position.</p>

Characteristics

`triggmode` is an alias data type for `num` and consequently inherits its characteristics.

Continues on next page

Related information

For information about	See
Use of triggers	TriggL - Linear robot movements with events on page 935 TriggC - Circular robot movement with events on page 891 TriggJ - Axis-wise robot movements with events on page 927
Definition of triggers	TriggEquip - Define a fixed position and time I/O event on the path on page 910 TriggInt - Defines a position related interrupt on page 916 TriggIO - Define a fixed position or time I/O event near a stop point on page 921 TriggRampAO - Define a fixed position ramp AO event on the path on page 958 TriggSpeed - Defines TCP speed proportional analog output with fixed position-time scale event on page 965
Define I/O check at a fixed position	TriggCheckIO - Defines I/O check at a fixed position on page 900
Storage of trigg data	triggdata - Positioning events, trigg on page 1785
Data types in general, alias data types	<i>Technical reference manual - RAPID Overview, section Basic characteristics - Data types</i>

3 Data types

3.94 triggstrgo - Positioning events, trigg *RobotWare Base*

3.94 triggstrgo - Positioning events, trigg

Usage

`triggstrgo`(*trigg stringdig group output*) is used to store data about a positioning event during a robot movement. When the positioning event is distributed at a specific position on the path, a group of digital output signals is set to a specified value.

Description

`triggstrgo` is used to define conditions and actions for setting a group of digital output signals at a fixed position along the robot's movement path.

Components

`used`

Data type: `bool`

Defines whether or not the array element should be used or not.

`distance`

Data type: `num`

Defines the position on the path where the I/O event shall occur. Specified as the distance in mm (positive value) from the end point of the movement path if component `start` is set to `FALSE`.

`start`

Data type: `bool`

Set to `TRUE` when the distance starts at the movement start point instead of the end point.

`equiplag`

Equipment Lag

Data type: `num`

Specify the lag for the external equipment in s.

For compensation of external equipment lag, use a positive argument value. Positive value means that the I/O signal is set by the robot system at a specified time before the TCP physically reaches the specified distance in relation to the movement start or end point.

Negative value means that the I/O signal is set by the robot system at a specified time after that the TCP has physically passed the specified distance in relation to the movement start or end point.

Continues on next page

The figure shows use of component `equiplag`.

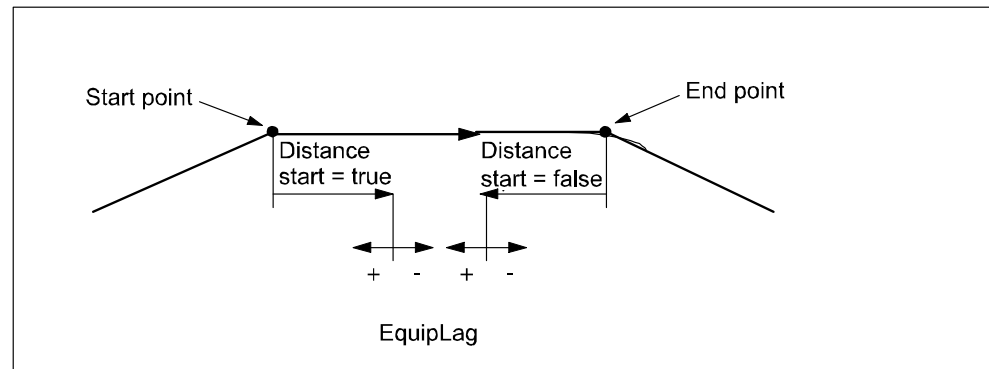

xx0800000173

signalname

Data type: string

The name of the signal that shall be changed. It has to be a name of a group output signal.

setvalue

Data type: stringdig

Desired value of output signal (within the allowed range for the current digital group output signal). Using `stringdig` data type makes it possible to use values up to 4294967295, which is the maximum value a group of digital signals can have (32 signals in a group signal is max for the system).

xxx

Data type: num

Component is not used right now. Added to be able to add functionality in future releases, and still be able to be compatible.

Examples

The following example illustrates the data type `triggstrgo`:

Example 1

```
VAR triggstrgo gunon{1};

gunon{1}.used:=TRUE;
gunon{1}.distance:=3;
gunon{1}.start:=TRUE;
gunon{1}.signalname:="gun";
gunon{1}.equiplag:=0;
gunon{1}.setvalue:="4294967295";

MoveJ p1, v500, z50, gun1;
TriggLIOS p2, v500, \TriggData2:=gunon, z50, gun1;
MoveL p3, v500, z50, gun1;
```

The signal `gun` is set to value 4294967295 when the TCP is 3 mm after point `p1`.

Continues on next page

3 Data types

3.94 triggstrgo - Positioning events, trigg

RobotWare Base

Continued

Structure

```
<dataobject of triggstrgo>  
<used of bool>  
<distance of num>  
<start of bool>  
<equiplag of num>  
<signalname of string>  
<setvalue of stringdig>  
<xxx of num>
```

Related information

For information about	See
Linear robot movements with I/O events	TriggLIOs - Linear robot movements with I/O events on page 950
Compare two strings with only digits	StrDigCmp - Compare two strings with only digits on page 1483
Arithmetic operations on stringdig data types	StrDigCalc - Arithmetic operations with data-type stringdig on page 1480

3.95 tsp_status - Task selection panel status

Usage

`tsp_status` is used to mirror the status of the **Task Selection Panel** on the FlexPendant.

Description

With the functions `TaskIsActive` and `GetTSPStatus`, it is possible to read out current status of **Task Selection Panel** on the FlexPendant.

Basic examples

The following example illustrates the data type `tsp_status`:

Example 1

```

VAR tsp_status tspstatus;
...
tspstatus:=GetTSPStatus("MYTASK");
IF tspstatus >= TSP_NORMAL_UNCHECKED AND tspstatus <=
    TSP_SEMISTATIC_UNCHECKED THEN
    TPWrite "Task MYTASK is unchecked in the Task Selection Panel";
ELSEIF tspstatus >= TSP_NORMAL_CHECKED THEN
    TPWrite "Task MYTASK is checked in the Task Selection Panel";
ELSE
    TPWrite "Task MYTASK is unchecked in TSP due to execution in
        service routine";
ENDIF

```

This program example investigates if program task `MYTASK` is checked or unchecked in the **Task Selection Panel** on the FlexPendant.

Predefined data

Following constants of type `tsp_status` are predefined:

RAPID constant	Value	Description
<code>TSP_STATUS_NOT_NORMAL_TASK</code>	0	<code>TaskIsActive</code> . The task is a semistatic or static task, not a normal task.
<code>TSP_STATUS_DEACT</code>	1	<code>TaskIsActive</code> . The normal task is deactivated in the Task Selection Panel.
<code>TSP_STATUS_DEACT_SERV_ROUT</code>	2	<code>TaskIsActive</code> . The normal task is deactivated in the Task Selection Panel because some other task is executing a service routine.
<code>TSP_STATUS_ACT</code>	3	<code>TaskIsActive</code> . The normal task is active in the Task Selection Panel.
<code>TSP_UNCHECKED_RUN_SERV_ROUT</code>	10	<code>GetTSPStatus</code> . The normal task is unchecked in the Task Selection Panel because some other task is executing a service routine.
<code>TSP_NORMAL_UNCHECKED</code>	11	<code>GetTSPStatus</code> . The normal task is unchecked in the Task Selection Panel.

Continues on next page

3 Data types

3.95 tsp_status - Task selection panel status

RobotWare Base

Continued

RAPID constant	Value	Description
TSP_STATIC_UNCHECKED	12	GetTSPStatus. The static task is unchecked in the Task Selection Panel.
TSP_SEMISTATIC_UNCHECKED	13	GetTSPStatus. The semistatic task is unchecked in the Task Selection Panel.
TSP_NORMAL_CHECKED	14	GetTSPStatus. The normal task is checked in the Task Selection Panel.
TSP_STATIC_CHECKED	15	GetTSPStatus. The static task is checked in the Task Selection Panel.
TSP_SEMISTATIC_CHECKED	16	GetTSPStatus. The semistatic task is checked in the Task Selection Panel.

Characteristics

tsp_status is an alias data type for num and consequently inherits its characteristics.

Related information

For information about	See
Get current task selection panel status	GetTSPStatus - Get current task selection panel status on page 1315
Check if a normal task is active	TasksActive - Check if a normal task is active on page 1510

3.96 tunetype - Servo tune type

Usage

`tunetype` is used to represent an integer with a symbolic constant for different types of servo tuning.

Description

A `tunetype` constant is intended to be used as an argument to the instruction `TuneServo`.

Basic examples

The following example illustrates the data type `tunetype`:

Example 1

```
TuneServo MHA160R1, 1, 110 \Type:= TUNE_KP;
```

Predefined data

The following symbolic constants of the data type `tunetype` are predefined and can be used as arguments for the instruction `TuneServo`.

Value	Symbolic constant	Comment
0	TUNE_DF	Reduces overshoots
1	TUNE_KP	Affects position control gain
2	TUNE_KV	Affects speed control gain
3	TUNE_TI	Affects speed control integration time
4	TUNE_FRIC_LEV	Affects friction compensation level
5	TUNE_FRIC_RAMP	Affects friction compensation ramp
6	TUNE_DG	Only for ABB internal use
7	TUNE_DH	Reduces vibrations with heavy loads
8	TUNE_DI	Only for ABB internal use
9	TUNE_DK	Only for ABB internal use
10	TUNE_DL	Only for ABB internal use

Characteristics

`tunetype` is an alias data type for `num` and consequently inherits its characteristics.

Related information

For information about	See
Data types in general, alias data types	<i>Technical reference manual - RAPID Overview</i> , section <i>Basic characteristics - Data types</i>
Use of data type <code>tunetype</code>	TuneServo - Tuning servos on page 985

3 Data types

3.97 uishownum - Instance ID for UIShow

RobotWare Base

3.97 uishownum - Instance ID for UIShow

Usage

`uishownum` is the data type used for parameter `InstanceId` in instruction `UIShow`. It is used to identify a view on the FlexPendant.

Description

When a persistent variable of type `uishownum` is used with the instruction `UIShow`, it is given a specific value identifying the view launched on the FlexPendant. This persistent is then used in all dealings with that view, such as launching the view again, modifying the view, etc.

Examples

The following example illustrates the data type `uishownum`:

Example 1

```
CONST string Name:="TpsViewMyAppl.gtpu.dll";
CONST string Type:="ABB.Robotics.SDK.Views.TpsViewMyAppl";
CONST string Cmd1:="Init data string passed to the view";
PERS uishownum myinstance:=0;
VAR num mystatus:=0;
...
! Launch one view of the application MyAppl
UIShow Name, Type \InitCmd:=Cmd1 \InstanceID:=myinstance
      \Status:=mystatus;
```

The code above will launch one view of the application `MyAppl` with init command `Cmd1`. The token used to identify the view is saved in the parameter `myinstance`.

Characteristics

`uishownum` is an alias data type for `num` and thus inherits its properties.

Related information

For information about	See
UIShow	UIShow - User Interface show on page 1006

3.98 weavestartdata - weave start data

Usage

`weavestartdata` is used to control stationary weaving during start and restart of a process in CAP.

`weavestartdata` is a component of `capdata` and defines the properties of stationary weaving at start or restart of a CAP process:

- if there shall be stationary weaving at start (`active`)
- width of stationary weaving (`width`)
- direction relative path direction (`dir`)
- frequency of stationary weaving (`cycle_time`)

Stationary weaving uses always geometric weaving with zig-zag pattern, see [capweavedata - Weavedata for CAP on page 1628](#).

Components

active

Data type: `bool`

Value	Description
TRUE	Perform stationary weaving at start of a CAP process
FALSE	Do NOT perform stationary weaving at start of a CAP process

width

Data type: `num`

Defines the amplitude of stationary weaving (mm).

dir

Data type: `num`

Defines the direction of stationary weaving relative to the path direction (degrees). Zero degrees means weaving perpendicular to both the path and the z-coordinate of the tool.

cycle_time

Data type: `num`

Defines the total time (in seconds) for a complete cycle of stationary weaving, that is, it defines the weaving frequency. The stationary weaving will last until the process has started, that is, the supervision criteria of the `START_MAIN` phase are fulfilled.

Syntax

```

< data object of weavestartdata >
  < active of bool >
  < width of num >
  < dir of num >
  < cycle_time of num >

```

Continues on next page

3 Data types

3.98 weavestartdata - weave start data

Continuous Application Platform (CAP)

Continued

Related information

	Described in:
capdata data type	capdata - CAP data on page 1614
<i>Continuous Application Platform</i>	<i>Application manual - Continuous Application Platform</i>

3.99 wobjdata - Work object data

Usage

wobjdata is used to describe the work object that the robot welds, processes, moves within, etc.

Description

If work objects are defined in a positioning instruction, the position will be based on the coordinates of the work object. The advantages of this are as follows:

- If position data is entered manually, such as in off-line programming, the values can often be taken from a drawing.
- Programs can be reused quickly following changes in the robot installation. If, for example, the fixture is moved, only the user coordinate system has to be redefined.
- Variations in how the work object is attached can be compensated for. For this, however, some sort of sensor will be required to position the work object.

If a stationary tool or coordinated external axes are used, the work object must be defined, since the path and velocity would then be related to the work object instead of the TCP.

Work object data can also be used for jogging:

- The robot can be jogged in the directions of the work object.
- The current position displayed is based on the coordinate system of the work object.

Basic examples

The following example illustrates the data type wobjdata:

Example 1

```
PERS wobjdata wobj2 :=[ FALSE, TRUE, "", [ [300, 600, 200], [1, 0,
0 ,0] ], [ [0, 200, 30], [1, 0, 0 ,0] ] ];
```

The work object in the figure above is described using the following values:

- The robot is not holding the work object.
- The fixed user coordinate system is used.
- The user coordinate system is not rotated and the coordinates of its origin are x= 300, y = 600 and z = 200 mm in the world coordinate system.
- The object coordinate system is not rotated and the coordinates of its origin are x= 0, y= 200 and z= 30 mm in the user coordinate system.

```
wobj2.oframe.trans.z := 38.3;
```

- The position of the work object wobj2 is adjusted to 38.3 mm in the z-direction.

Predefined data

The work object data wobj0 is defined in such a way that the object coordinate system coincides with the world coordinate system. The robot does not hold the work object.

Continues on next page

3 Data types

3.99 wobjdata - Work object data

RobotWare Base

Continued

Wobj0 can always be accessed from the program, but can never be changed (it is stored in system module BASE).

```
PERS wobjdata wobj0 := [ FALSE, TRUE, "", [ [0, 0, 0], [1, 0, 0, 0], [0, 0, 0], [1, 0, 0, 0] ] ];
```

Components

robhold

robot hold

Data type: bool

Defines whether or not the robot in the actual program task is holding the work object:

- TRUE: The robot is holding the work object, i.e. using a stationary tool.
- FALSE: The robot is not holding the work object, i.e. the robot is holding the tool.

ufprog

user frame programmed

Data type: bool

Defines whether or not a fixed user coordinate system is used:

- TRUE: Fixed user coordinate system.
- FALSE: Movable user coordinate system, i.e. coordinated external axes are used. Also to be used in a MultiMove system in semicoordinated or synchronized coordinated mode.

ufmec

user frame mechanical unit

Data type: string

The mechanical unit with which the robot movements are coordinated. Only specified in the case of movable user coordinate systems (ufprog is FALSE).

Specify the mechanical unit name defined in system parameters, e.g. orbit_a.

uframe

user frame

Data type: pose

The user coordinate system, i.e. the position of the current work surface or fixture (see figure below):

- The position of the origin of the coordinate system (x, y and z) in mm.
- The rotation of the coordinate system, expressed as a quaternion (q1, q2, q3, q4).

If the robot is holding the tool, the user coordinate system is defined in the world coordinate system (in the wrist coordinate system if a stationary tool is used).

For movable user frame (ufprog is FALSE), the user frame is continuously defined by the system.

Continues on next page

oframe

object frame

Data type: pose

The object coordinate system, i.e. the position of the current work object (see figure below):

- The position of the origin of the coordinate system (x, y and z) in mm.
- The rotation of the coordinate system, expressed as a quaternion (q1, q2, q3, q4).

The object coordinate system is defined in the user coordinate system.

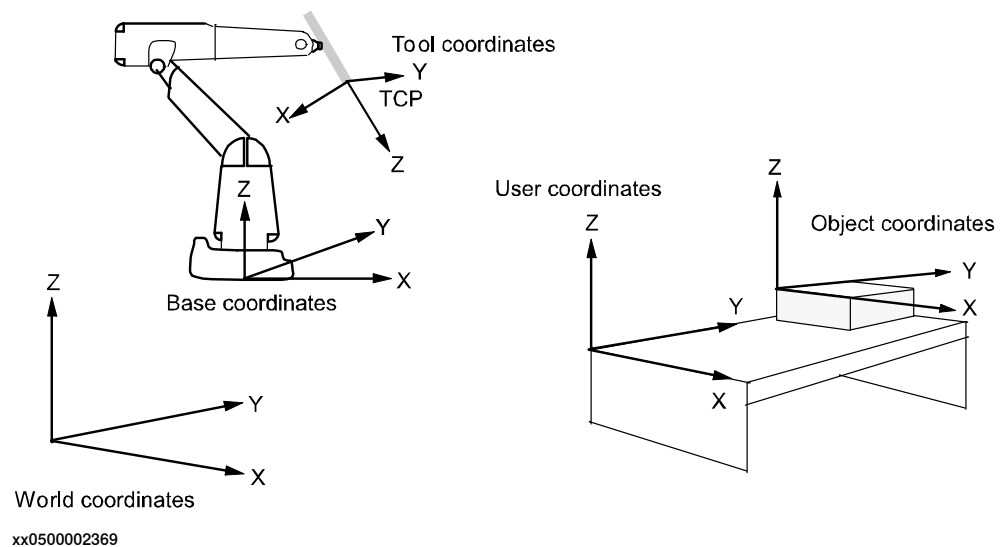

Structure

```

< dataobject of wobjdata >
  < robhold of bool >
  < ufprog of bool >
  < ufmec of string >
  < uframe of pose >
    < trans of pos >
      < x of num >
      < y of num >
      < z of num >
    < rot of orient >
      < q1 of num >
      < q2 of num >
      < q3 of num >
      < q4 of num >
  < oframe of pose >
    < trans of pos >
      < x of num >
      < y of num >
      < z of num >
    < rot of orient >
      < q1 of num >
  
```

Continues on next page

3 Data types

3.99 wobjdata - Work object data

RobotWare Base

Continued

< q2 of num >

< q3 of num >

< q4 of num >

Limitations

The work object data should be defined as a persistent variable (*PERS*) and should not be defined within a routine. The current values are then saved when the program is saved and are retrieved on loading.

Arguments of the type work object data in any motion instruction should only be an entire persistent (not array element or record component).

Related information

For information about	See
Positioning instructions	<i>Technical reference manual - RAPID Overview, section RAPID summary - Motion</i>
Coordinate systems	<i>Technical reference manual - RAPID Overview, section Motion and I/O Principles - Coordinate systems</i>
Coordinated external axes	<i>Technical reference manual - RAPID Overview, section Motion and I/O Principles - Coordinate systems</i>
Calibration of coordinated axes	<i>Application manual - Additional axes and standalone controller</i> <i>Application manual - MultiMove</i>

3.100 wzstationary - Stationary world zone data

Usage

`wzstationary` (*world zone stationary*) is used to identify a stationary world zone and can only be used in an event routine connected to the event POWER ON.

A world zone is supervised during robot movements both during program execution and jogging. If the robot's TCP reaches the world zone or if the robot/external axes reaches the world zone in joints, the movement is stopped or a digital output signal is set or reset.

Description

A `wzstationary` world zone is defined and activated by a `WZLimSup` or a `WZDOSet` instruction.

`WZLimSup` or `WZDOSet` gives the variable or the persistent of data type `wzstationary` a numeric value. The value identifies the world zone.

A stationary world zone is always active in motor on state and is only erased by a **Restart**. It is not possible to deactivate, activate or erase a stationary world zone via **RAPID** instructions.

Stationary world zones should be active from power on and should be defined in a **POWER ON** event routine or a semistatic task

Basic examples

The following example illustrates the data type `wzstationary`:

Example 1

```
VAR wzstationary conveyor;  
...  
PROC ...  
  VAR shapedata volume;  
  ...  
  WZBoxDef \Inside, volume, p_corner1, p_corner2;  
  WZLimSup \Stat, conveyor, volume;  
ENDPROC
```

A `conveyor` is defined as a straight box (the volume below the belt). If the robot reaches this volume, the movement is stopped.

More examples

For a complete example see instruction `WZLimSup`.

Limitations

A `wzstationary` data can be defined as a variable (**VAR**) or as a persistent (**PERS**). It can be global in task or local within module, but not local within a routine. Arguments of the type `wzstationary` should only be entire data (not array element or record component).

An init value for data of the type `wzstationary` is not used by the control system. When there is a need to use a persistent variable in a multi-tasking system, set

Continues on next page

3 Data types

3.100 wzstationary - Stationary world zone data

World Zones

Continued

the init value to 0 in both tasks, e.g. PERS wzstationary share_workarea := [0];

Characteristics

wzstationary is an alias data type of wztemporary and inherits its characteristics.

Related information

For information about	See
World Zones	<i>Technical reference manual - RAPID Overview, section Motion and I/O principles - World zones</i>
World zone shape	shapedata - World zone shape data on page 1743
Temporary world zone	wztemporary - Temporary world zone data on page 1809
Activate world zone limit supervision	WZLimSup - Activate world zone limit supervision on page 1138
Activate world zone digital output set	WZDOSet - Activate world zone to set digital output on page 1123

3.101 wztemporary - Temporary world zone data

Usage

`wztemporary` (*world zone temporary*) is used to identify a temporary world zone and can be used anywhere in the RAPID program for any motion task.

A world zone is supervised during robot movements both during program execution and jogging. If the robot's TCP reaches the world zone or if the robot/external axes reaches the world zone in joints, the movement is stopped or a digital output signal is set or reset.

Description

A `wztemporary` world zone is defined and activated by a `WZLimSup` or a `WZDOSet` instruction.

`WZLimSup` or `WZDOSet` gives the variable or the persistent of data type `wztemporary` a numeric value. The value identifies the world zone.

Once defined and activated, a temporary world zone can be deactivated by `WZDisable`, activated again by `WZEnable`, and erased by `WZFree`.

All temporary world zones in the motion task are automatically erased and all data objects of type `wztemporary` in the motion task are set to 0:

- when a new program is loaded in the motion task
- when starting program execution from the beginning in the motion task

Basic examples

The following example illustrates the data type `wztemporary`:

Example 1

```
VAR wztemporary roll;
...
PROC
  VAR shapedata volume;
  CONST pos t_center := [1000, 1000, 1000];
  ...
  WZCylDef \Inside, volume, t_center, 400, 1000;
  WZLimSup \Temp, roll, volume;
ENDPROC
```

A `wztemporary` variable, `roll`, is defined as a cylinder. If the robot reaches this volume, the movement is stopped.

More examples

For a complete example see instruction `WZDOSet`.

Limitations

A `wztemporary` data can be defined as a variable (VAR) or as a persistent (PERS). It can be global in a task or local within a module, but not local within a routine.

Arguments of the type `wztemporary` must only be entire data, not an array element or record component.

Continues on next page

3 Data types

3.101 wztemporary - Temporary world zone data

RobotWare Base

Continued

A temporary world zone must only be defined (`WZLimSup` or `WZDOSet`) and free (`WZFree`) in the motion task. Definitions of temporary world zones in any background is not allowed because it would affect the program execution in the connected motion task. The instructions `WZDisable` and `WZEnable` can be used in the background task. When there is a need to use a persistent variable in a multi-tasking system, set the init value to 0 in both tasks, e.g. `PERS wztemporary share_workarea := [0];`

Structure

```
< dataobject of wztemporary >  
  < wz of num >
```

Related information

For information about	See
World Zones	<i>Technical reference manual - RAPID Overview, section Motion and I/O principles - World zones</i>
World zone shape	shapedata - World zone shape data on page 1743
Stationary world zone	wzstationary - Stationary world zone data on page 1807
Activate world zone limit supervision	WZLimSup - Activate world zone limit supervision on page 1138
Activate world zone digital output set	WZDOSet - Activate world zone to set digital output on page 1123
Deactivate world zone	WZDisable - Deactivate temporary world zone supervision on page 1121
Activate world zone	WZEnable - Activate temporary world zone supervision on page 1127
Erase world zone	WZFree - Erase temporary world zone supervision on page 1129

3.102 zonedata - Zone data

Usage

`zonedata` is used to specify how a position is to be terminated, i.e. how close to the programmed position the axes must be before moving towards the next position.

Description

A position can be terminated either in the form of a stop point or a fly-by point.

A stop point means that the robot and additional axes must reach the specified position (stand still) before program execution continues with the next instruction. It is also possible to define stop points other than the predefined `fine`. The stop criteria, that tells if the robot is considered to have reached the point, can be manipulated using the `stoppointdata`.

A fly-by point means that the programmed position is never attained. Instead, the direction of motion is changed before the position is reached. Two different zones (ranges) can be defined for each position:

- The position zone for the TCP path.
- The reorientation and additional axis zone.

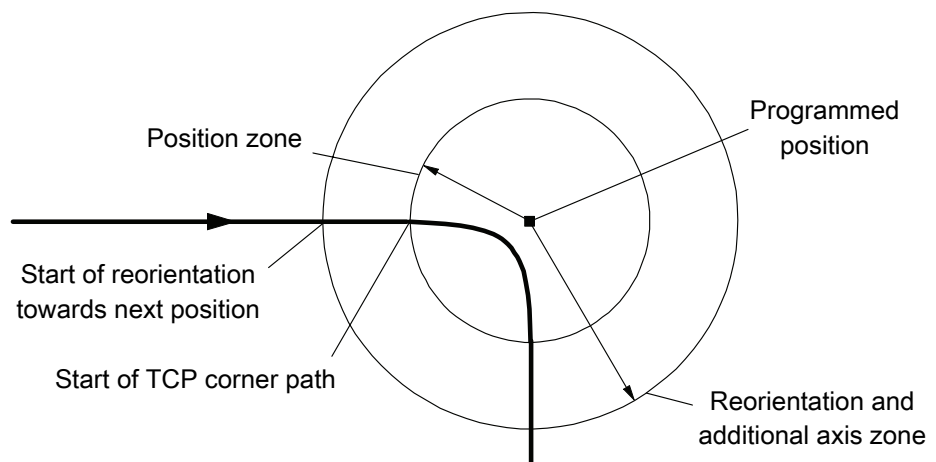

xx180000945

The zone for the TCP path

A corner path is generated as soon as the edge of the corner zone is reached (see figure above).

Continues on next page

3 Data types

3.102 zonedata - Zone data

RobotWare Base

Continued

Calculation of reorientation and additional axis zone

The datatype `zonedata` contains one component that determines the position zone, `pzone_tcp`. But the reorientation and additional axis zone can be affected by all of the following `zonedata` components.

- `pzone_ori` - zone radius, in mm TCP movement, for reorientation of the tool
- `pzone_eax` - zone radius, in mm TCP movement, for movement of the additional axis
- `zone_ori` - angle zone, in degrees of tool reorientation
- `zone_leax` - zone size, in mm of linear additional axis movement
- `zone_reax` - angle zone, in degrees of rotational additional axis reorientation

The size of the reorientation and additional axis zone is generally limited by the smallest zone generated from the applicable components above. The zone will be defined as the smallest relative size of the zone based upon the zone components and the programmed motion.

If the calculations result in a reorientation and additional axis zone that is smaller than the position zone, the reorientation and additional axis zone will be set to the same size as the position zone. The exception is if there is no (or almost no) TCP position movement. If the reorientation is large and the position movement is small, the position zone can be reduced to the size of the reorientation and additional axis zone.

Reorientation and additional axis zone limited by zone_ori

The following figure shows an example of the reorientation and additional axis zone being reduced to 36% of the motion due to `zone_ori`.

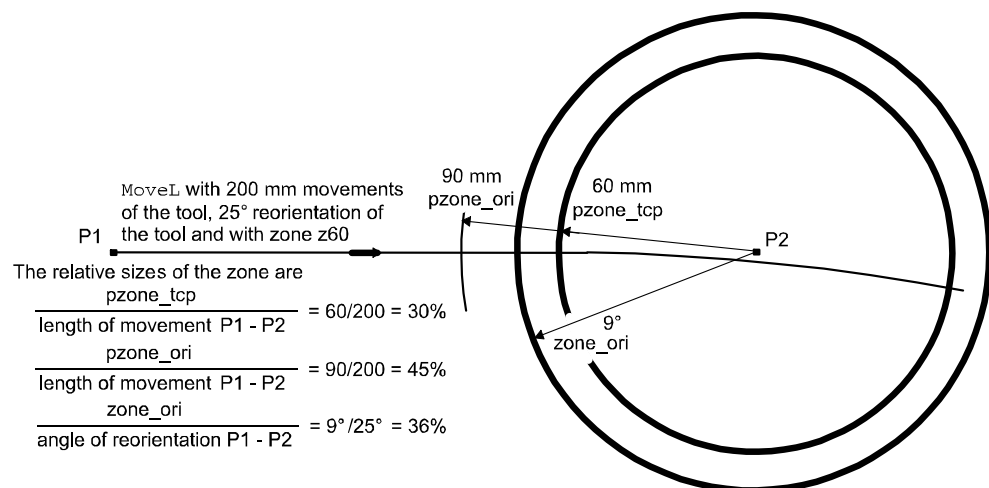

xx0500002362

Reorientation and additional axis zone increased to position zone

The size of the reorientation and additional axis zone must never be smaller than the position zone. So if, for example, `zone_ori` result in a smaller size than `pzone_tcp`, the reorientation and additional axis zone is increased to the size of the position zone.

Continues on next page

The following figure shows an example where `zone_ori` would result in a reorientation and additional axis zone of 15% of the motion, but is increased to 30% of the motion to match the position zone.

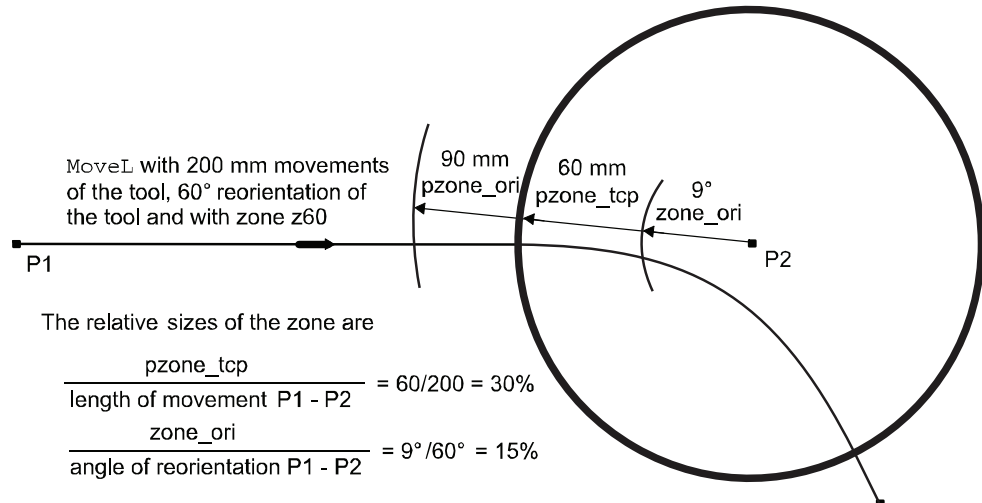

xx0500002363

Formulas for calculating the reorientation and additional axis zone

Normally not all `zonedata` components are applicable. For example, for a rotational additional axis reorientation without robot movement, only `zone_reax` is applicable.

For all `zonedata` components that are applicable, the smallest of the following relations determine the size of the reorientation and additional axis zone (as long as it is larger or equal to the position zone).

$$\frac{\text{pzone_ori}}{\text{length of movement P1 - P2}}$$

$$\frac{\text{zone_ori}}{\text{angle of tool reorientation P1 - P2}}$$

$$\frac{\text{pzone_eax}}{\text{length of movement P1 - P2}}$$

$$\frac{\text{pzone_leax}}{\text{length of max linear add. axis movement P1 - P2}}$$

$$\frac{\text{pzone_reax}}{\text{angle of max reorientation of rotating add. axis P1 - P2}}$$

xx1800000781

Reduced corner zones

If programmed positions are close to each other and the corner zones are big, the corner zones can be reduced from the programmed size. See section *Interpolation of corner paths* in *Technical reference manual - RAPID Overview*.

Continues on next page

3 Data types

3.102 zonedata - Zone data

RobotWare Base

Continued

Basic examples

The following example illustrates the data type `zonedata`:

Example 1

```
VAR zonedata path := [ FALSE, 25, 40, 40, 10, 35, 5 ];
```

The zone data `path` is defined by means of the following characteristics:

- The zone size for the TCP path is 25 mm.
- The zone size for the tool reorientation is 40 mm (TCP movement).
- The zone size for external axes is 40 mm (TCP movement).

If the TCP is standing still, or there is a large reorientation, or there is a large external axis movement with respect to the zone, the following apply instead:

- The zone size for the tool reorientation is 10 degrees.
- The zone size for linear external axes is 35 mm.
- The zone size for rotating external axes is 5 degrees.

Predefined data

A number of zone data are already defined in the system.

Stop points

Use `zonedata` named `fine`.

Fly-by points

Path zone				Zone		
Name	TCP path	Orientation	Ext. axis	Orientation	Linear axis	Rotating axis
z0	0.3 mm	0.3 mm	0.3 mm	0.03°	0.3 mm	0.03°
z1	1 mm	1 mm	1 mm	0.1°	1 mm	0.1°
z5	5 mm	8 mm	8 mm	0.8°	8 mm	0.8°
z10	10 mm	15 mm	15 mm	1.5°	15 mm	1.5°
z15	15 mm	23 mm	23 mm	2.3°	23 mm	2.3°
z20	20 mm	30 mm	30 mm	3.0°	30 mm	3.0°
z30	30 mm	45 mm	45 mm	4.5°	45 mm	4.5°
z40	40 mm	60 mm	60 mm	6.0°	60 mm	6.0°
z50	50 mm	75 mm	75 mm	7.5°	75 mm	7.5°
z60	60 mm	90 mm	90 mm	9.0°	90 mm	9.0°
z80	80 mm	120 mm	120 mm	12°	120 mm	12°
z100	100 mm	150 mm	150 mm	15°	150 mm	15°
z150	150 mm	225 mm	225 mm	23°	225 mm	23°
z200	200 mm	300 mm	300 mm	30°	300 mm	30°

Components

`finep`

fine point

Continues on next page

Data type: bool

Defines whether the movement is to terminate as a stop point (*fine point*) or as a fly-by point.

- **TRUE:** The movement terminates as a stop point, and the program execution will not continue until robot reach the stop point. The remaining components in the zone data are not used.
- **FALSE:** The movement terminates as a fly-by point, and the program execution continues when the prefetch conditions have been met (see system parameter *Prefetch Time*).

pzone_tcp

path zone TCP

Data type: num

The size (the radius) of the TCP zone in mm.

pzone_ori

path zone orientation

Data type: num

The zone size (the radius) for the tool reorientation. The size is defined as the distance of the TCP from the programmed point in mm.

The size must be larger than the corresponding value for pzone_tcp. If a lower value is specified, the size is automatically increased to make it the same as pzone_tcp.

pzone_eax

path zone external axes

Data type: num

The zone size (the radius) for external axes. The size is defined as the distance of the TCP from the programmed point in mm.

The size must be larger than the corresponding value for pzone_tcp. If a lower value is specified, the size is automatically increased to make it the same as pzone_tcp.

zone_ori

zone orientation

Data type: num

The zone size for the tool reorientation in degrees. If the robot is holding the work object, this means an angle of rotation for the work object.

zone_leax

zone linear external axes

Data type: num

The zone size for linear external axes in mm.

zone_reax

zone rotational external axes

Continues on next page

3 Data types

3.102 zonedata - Zone data

RobotWare Base

Continued

Data type: num

The zone size for rotating external axes in degrees.

Structure

```
<data object of zonedata>  
<finep of bool>  
<pzone_tcp of num>  
<pzone_ori of num>  
<pzone_eax of num>  
<zone_ori of num>  
<zone_leax of num>  
<zone_reax of num>
```

Related information

For information about	See
Positioning instructions	<i>Technical reference manual - RAPID Overview</i>
Movements/Paths in general	<i>Technical reference manual - RAPID Overview</i>
Configuration of external axes	<i>Application manual - Additional axes and standalone controller</i>
Other Stop points	stoppointdata - Stop point data on page 1755

4 Programming type examples

4.1 ERROR handler with movements

Usage

These type examples describe how to use move instructions in an ERROR handler after an asynchronously raised process or movement error has occurred.

This function can only be used in the main task `T_ROB1` or, if in a MultiMove system, in Motion tasks.

Description

The `ERROR` handler can start a new temporary movement and finally restart the original interrupted and stopped movement. For example, it can be used to go to a service position or to clean the gun after an asynchronously raised process or movement error has occurred.

To reach this functionality, the instructions `StorePath` - `RestoPath` must be used in the `ERROR` handler. To restart the movement and continue the program execution, several `RAPID` instructions are available.

Type examples

Type examples of the functionality are illustrated below.

Principle

```
...
ERROR
  IF ERRNO = ERR_PATH_STOP THEN
    StorePath;
    ! Move away and back to the interrupted position
    ...
    RestoPath;
    StartMoveRetry;
  ENDIF
ENDPROC
```

At execution of `StartMoveRetry` the robot resumes its movement, any active process is restarted and the program retries its execution. `StartMoveRetry` does the same as `StartMove` plus `RETRY` in one indivisible operation.

Automatic restart of execution

```
CONST robtargt service_pos := [...];
VAR robtargt stop_pos;
...
ERROR
  IF ERRNO = AW_WELD_ERR THEN
    ! Current movement on motion base path level
    ! is already stopped.
    ! New motion path level for new movements in the ERROR handler
    StorePath;
    ! Store current position from motion base path level
```

Continues on next page

4 Programming type examples

4.1 ERROR handler with movements

Path Recovery

Continued

```
stop_pos := CRobT(\Tool:=tool1, \WObj:=wobj1);
! Do the work to fix the problem
MoveJ service_pos, v50, fine, tool1, \WObj:=wobj1;
...
! Move back to the position on the motion base path level
MoveJ stop_pos, v50, fine, tool1, \WObj:=wobj1;
! Go back to motion base path level
RestoPath;
! Restart the stopped movements on motion base path level,
! restart the process and retry program execution
StartMoveRetry;
ENDIF
ENDPROC
```

This is a type example of how to use automatic asynchronously error recovery after some type of process error during robot movements.

Manual restart of execution

```
...
ERROR
IF ERRNO = PROC_ERR_XXX THEN
! Current movement on motion base path level
! is already stopped and in stop move state.
! This error must be handle manually.
! Reset the stop move state on motion base path level.
StopMoveReset;
ENDIF
ENDPROC
```

This is a type example of how to use manual handling of asynchronously error recovery after some type of process error during robot movements.

After the above `ERROR` handler has executed to the end, the program execution stops and the program pointer is at the beginning of the instruction with the process error (also at beginning of any used `NOSTEPIN` routine). The next program start restarts the program and movement from the position in which the original process error occurred.

Program execution

Execution behavior:

- At start execution of the `ERROR` handler, the program leaves its base execution level
- At execution of `StorePath`, the motion system leaves its base execution level
- At execution of `RestoPath`, the motion system returns to its base execution level
- At execution of `StartMoveRetry`, the program returns to its base execution level

Continues on next page

Limitations

The following `RAPID` instructions must be used in the `ERROR` handler with move instructions to get it working for automatically error recovery after an asynchronously raised process or path error:

Instruction	Description
<code>StorePath</code>	Enter new motion path level
<code>RestoPath</code>	Return to motion base path level
<code>StartMoveRetry</code>	Restart the interrupted movements on the motion base path level. Also restart the process and retry the program execution. Same functionality as <code>StartMove + RETRY</code> .

The following `RAPID` instruction must be used in the `ERROR` handler to get it working for manually error recovery after an asynchronously raised process or path error:

Instruction	Description
<code>StopMoveReset</code>	Enter new motion path level

Related information

For information about	See
To enter a new motion path level	StorePath - Stores the path when an interrupt occurs on page 826
To return to motion base path level	RestoPath - Restores the path after an interrupt on page 618
To restart the interrupted movement, process and retry program execution.	StartMoveRetry - Restarts robot movement and execution on page 794

4 Programming type examples

4.2 Service routines with or without movements

Path recovery

4.2 Service routines with or without movements

Usage

These type examples describe how to use movement instructions in a service routine. The same principle about `StopMove`, `StartMove`, and `StopMoveReset` are also valid for service routines without movements (only logical instructions). Both service routines or other routines (procedures) without parameters can be started manually and perform movements according to these type examples. This functionality can only be used in the main task `T_ROB1` or, if in a MultiMove system, in Motion tasks in independent or semi-coordinated mode.

Description

The service routine can start a new temporary movement and, at later program start, restart the original movement. For example, it can be used to go to a service position or manually start cleaning the gun.

To reach this functionality the instructions `StorePath` - `RestoPath` and `StopMoveReset` must be used in the service routine.

Type examples

Type examples of the functionality are illustrated below.

Principle

```
PROC xxxx()  
  StopMove;  
  StorePath;  
  ! Move away and back to the interrupted position  
  ...  
  RestoPath;  
  StopMoveReset;  
ENDPROC
```

`StopMove` is required in order to make sure that the originally stopped movement is not restarted upon a manually "stop program-restart program" sequence during execution of the service routine.

Stop on path

```
VAR robtargt service_pos := [...];  
...  
PROC proc_stop_on_path()  
  VAR robtargt stop_pos;  
  ! Current stopped movements on motion base path level  
  ! must not be restarted in the service routine.  
  StopMove;  
  ! New motion path level for new movements in the service routine.  
  StorePath;  
  ! Store current position from motion base path level  
  stop_pos := CRobT(\Tool:=tool1 \WObj:=wobj1);  
  ! Do the work  
  MoveJ service_pos, v50, fine, tool1 \WObj:=wobj1;
```

Continues on next page

```
...
! Move back to interrupted position on the motion base path level
MoveJ stop_pos, v50, fine, tool1, \WObj:=wobj1;
! Go back to motion base path level
RestoPath;
! Reset the stop move state for the interrupted movement
! on motion base path level
StopMoveReset;
ENDPROC
```

In this type example the movements in the service routine start and end at the position on the path where the program was stopped.

Also note that the tool and work object used are known at the time of programming.

Stop in next stop point

```
TASK PERS tooldata used_tool := [...];
TASK PERS wobjdata used_wobj := [...];
...
PROC proc_stop_in_stop_point()
  VAR robtarget stop_pos;
  ! Current move instruction on motion base path level continue to
  ! its ToPoint and will be finished in a stop point.
  StartMove;
  ! New motion path level for new movements in the service routine
  StorePath;
  ! Get current tool and work object data
  GetSysData used_tool;
  GetSysData used_wobj;
  ! Store current position from motion base path level
  stop_pos := CRobT(\Tool:=used_tool \WObj:=used_wobj);
  ! Do the work
  MoveJ Offs(stop_pos,0,0,20),v50,fine,used_tool\WObj:=used_wobj;
  ...
  ! Move back to interrupted position on the motion base path level
  MoveJ stop_pos, v50, fine, used_tool,\WObj:=used_wobj;
  ! Go back to motion base path level
  RestoPath;
  ! Reset the stop move state for any new movement
  ! on motion base path level
  StopMoveReset;
ENDPROC
```

In this type example the movements in the service routine continue to and end at the ToPoint in the interrupted move instructions before the instruction StorePath is ready.

Also note that the tool and work object used are unknown at the time of programming.

4 Programming type examples

4.2 Service routines with or without movements

Path recovery

Continued

Program execution

Execution behavior:

- At start execution of the service routine, the program leaves its base execution level
 - At execution of `StorePath`, the motion system leaves its base execution level
 - At execution of `RestoPath`, the motion system returns to its base execution level
 - At execution of `ENDPROC`, the program returns to its base execution level
-

Limitations

The following `RAPID` instructions must be used in the service routine with move instructions to get it working:

Instruction	Description
<code>StorePath</code>	Enter new motion path level
<code>RestoPath</code>	Return to motion base path level
<code>StopMoveReset</code>	Reset the stop move state for the interrupted movement on the motion base path level

Related information

For information about	See
No restart of the already stopped movement on the motion base path level	StopMove - Stops robot movement on page 820
Restart of the already stopped movement on the motion base path level	StopMove - Stops robot movement on page 820
To enter a new motion path level	StorePath - Stores the path when an interrupt occurs on page 826
To return to the motion base path level	RestoPath - Restores the path after an interrupt on page 618
Reset the stop move state for the interrupted movement on the motion base path level	StopMoveReset - Reset the system stop move state on page 824

4.3 System I/O interrupts with or without movements

Usage

These type examples describe how to use movement instructions in a system I/O interrupt routine. The same principle about `StopMove`, `StartMove`, and `StopMoveReset` are also valid for system I/O interrupts without movements (only logical instructions).

This functionality can only be used in the main task `T_ROB1` or, if in a `MultiMove` system, in Motion tasks in independent or semi-coordinated mode.

Description

The system I/O interrupt routine can start a new temporary movement and, at later program start, restart the original movement. For example, it can be used to go to a service position or to clean the gun when an interrupt occurs.

To reach this functionality the instructions `StorePath - RestoPath` and `StopMoveReset` must be used in the system I/O interrupt routine.

Type examples

Type examples of the functionality are illustrated below.

Principle

```
PROC xxxx()
  StopMove;
  StorePath;
  ! Move away and back to the interrupted position
  ...
  RestoPath;
  StopMoveReset;
ENDPROC
```

`StopMove` is required in order to make sure that the originally stopped movement is not restarted at start of the I/O interrupt routine.

Without `StopMove` or with `StartMove` instead the movement in the I/O interrupt routine will continue at once and end at the `ToPoint` in the interrupted move instruction.

Stop on path

```
VAR robtargt service_pos := [...];
...
PROC proc_stop_on_path()
  VAR robtargt stop_pos;
  ! Current stopped movements on motion base path level is not
  restarted in the system I/O routine.
  StopMove;
  ! New motion path level for new movements in the system I/O
  routine.
  StorePath;
  ! Store current position from motion base path level
  stop_pos := CRobT(\Tool:=tool1 \WObj:=wobj1);
  ! Do the work
```

Continues on next page

4 Programming type examples

4.3 System I/O interrupts with or without movements

Path recovery

Continued

```
MoveJ service_pos, v50, fine, tool1 \WObj:=wobj1;
...
! Move back to interrupted position on the motion base path level
MoveJ stop_pos, v50, fine, tool1, \WObj:=wobj1;
! Go back to motion base path level
RestoPath;
! Reset the stop move state for the interrupted movement on motion
  base path level
StopMoveReset;
ENDPROC
```

In this type example the interrupted movements are stopped at once and are restarted at program start after the system I/O interrupt routine is finished.

Also note that the tool and work object used are known at the time of programming.

Stop in next stop point

```
TASK PERS tooldata used_tool := [...];
TASK PERS wobjdata used_wobj := [...];
...
PROC proc_stop_in_stop_point()
  VAR robtaraget stop_pos;
  ! Current move instruction on motion base path level continue to
    its ToPoint and will be finished in a stop point.
  StartMove;
  ! New motion path level for new movements in the system
  ! I/O routine
  StorePath;
  ! Get current tool and work object data
  GetSysData used_tool;
  GetSysData used_wobj;
  ! Store current position from motion base path level
  stop_pos := CRobT(\Tool:=used_tool \WObj:=used_wobj);
  ! Do the work
  MoveJ Offs(stop_pos,0,0,20),v50,fine,used_tool\WObj:=used_wobj;
  ...
  ! Move back to interrupted position on the motion base path level
  MoveJ stop_pos, v50, fine, used_tool,\WObj:=used_wobj;
  ! Go back to motion base path level
  RestoPath;
  ! Reset the stop move state for new movement
  ! on motion base path level
  StopMoveReset;
ENDPROC
```

In this type example the movements in the system I/O routine continue at once, and end at the ToPoint in the interrupted move instructions.

Also note that the tool and work object used are unknown at the time of programming.

Continues on next page

Program execution

Execution behavior:

- At start execution of the system I/O routine, the program leaves its base execution level
- At execution of `StorePath`, the motion system leaves its base execution level
- At execution of `RestoPath`, the motion system returns to its base execution level
- At execution of `ENDPROC`, the program returns to its base execution level

Limitations

The following `RAPID` instructions must be used in the system I/O routine with move instructions to get it working:

Instruction	Description
<code>StorePath</code>	Enter new motion path level
<code>RestoPath</code>	Return to motion base path level
<code>StopMoveReset</code>	Reset the stop move state for the interrupted movement on the motion base path level

Related information

For information about	See
No restart of the already stopped movement on the motion base path level	StopMove - Stops robot movement on page 820
Restart of the already stopped movement on the motion base path level	StartMove - Restarts robot movement on page 791
To enter a new motion path level	StorePath - Stores the path when an interrupt occurs on page 826
To return to the motion base path level	RestoPath - Restores the path after an interrupt on page 618
Reset the stop move state for the interrupted movement on the motion base path level	StopMoveReset - Reset the system stop move state on page 824

4 Programming type examples

4.4 Trap routines with movements

Path Recovery

4.4 Trap routines with movements

Usage

These type examples describe how to use move instructions in a trap routine after an interrupt has occurred.

This functionality can only be used in the main task `T_ROB1` or, if in a `MultiMove` system, in `Motion` tasks.

Description

The trap routine can start a new temporary movement and finally restart the original movement. For example, it can be used to go to a service position or to clean the gun when an interrupt occurs.

To reach this functionality the instructions `StorePath` - `RestoPath` and `StartMove` must be used in the trap routine.

Type examples

Type examples of the functionality are illustrated below.

Principle

```
TRAP xxxx
  StopMove;
  StorePath;
  ! Move away and back to the interrupted position
  ...
  RestoPath;
  StartMove;
ENDTRAP
```

If `StopMove` is used, the movement stops at once on the ongoing path; otherwise, the movement continues to the `ToPoint` in the actual move instruction.

Stop in next stop point

```
VAR robtargt service_pos := [...];
...
TRAP trap_in_stop_point
  VAR robtargt stop_pos;
  ! Current move instruction on motion base path level continue
  ! to its ToPoint and will be finished in a stop point.
  ! New motion path level for new movements in the TRAP
  StorePath;
  ! Store current position from motion base path level
  stop_pos := CRobT(\Tool:=tool1 \WObj:=wobj1);
  ! Do the work
  MoveJ service_pos, v50, fine, tool1 \WObj:=wobj1;
  ...
  ! Move back to interrupted position on the motion base path level
  MoveJ stop_pos, v50, fine, tool1, \WObj:=wobj1;
  ! Go back to motion base path level
  RestoPath;
  ! Restart the interrupted movements on motion base path level
```

Continues on next page

```
StartMove;  
ENDTRAP
```

In this type example the movements in the trap routine start and end at the `ToPoint` in the interrupted move instructions. Also note that the tool and work object are known at the time of programming.

Stop on path at once

```
TASK PERS tooldata used_tool := [...];  
TASK PERS wobjdata used_wobj := [...];  
...  
TRAP trap_stop_at_once  
  VAR robtarg stop_pos;  
  ! Current move instruction on motion base path level stops  
  ! at once  
  StopMove;  
  ! New motion path level for new movements in the TRAP  
  StorePath;  
  ! Get current tool and work object data  
  GetSysData used_tool;  
  GetSysData used_wobj;  
  ! Store current position from motion base path level  
  stop_pos := CRobT(\Tool:=used_tool \WObj:=used_wobj);  
  ! Do the work  
  MoveJ Offs(stop_pos,0,0,20),v50,fine,used_tool\WObj:=used_wobj;  
  ...  
  ! Move back to interrupted position on the motion base path level  
  MoveJ stop_pos, v50, fine, used_tool,\WObj:=used_wobj;  
  ! Go back to motion base path level  
  RestoPath;  
  ! Restart the interrupted movements on motion base path level  
  StartMove;  
ENDTRAP
```

In this type example the movements in the trap routine start and end at the position on the path where the interrupted move instruction was stopped. Also note that the tool and work object used are unknown at the time of programming.

Program execution

Execution behavior:

- At start execution of the trap routine, the program leaves its base execution level
- At execution of `StorePath`, the motion system leaves its base execution level
- At execution of `RestoPath`, the motion system returns to its base execution level
- At execution of `ENDTRAP`, the program returns to its base execution level

Continues on next page

4 Programming type examples

4.4 Trap routines with movements

Path Recovery

Continued

Limitations

The following `RAPID` instructions must be used in the trap routine with move instructions.

Instruction	Description
<code>StorePath</code>	Enter new motion path level
<code>RestoPath</code>	Return to motion base path level
<code>StartMove</code>	Restart the interrupted movements on the motion base path level

Related information

For information about	See
To stop the current movement at once	StopMove - Stops robot movement on page 820
To enter a new motion path level	StorePath - Stores the path when an interrupt occurs on page 826
To return to the motion base path level	RestoPath - Restores the path after an interrupt on page 618
To restart the interrupted movement	StartMove - Restarts robot movement on page 791

Index

A

Abs, 1143
 AbsDnum, 1145
 AccSet, 25
 ACos, 1147
 ACosDnum, 1148
 ActEventBuffer, 28
 ActUnit, 30
 Add, 32
 AInput, 1149
 aiotrigger, 1597
 ALIAS, 1599
 AliasCamera, 34
 AliasIO, 36
 AliasIOReset, 39
 AND, 1151
 AOutput, 1153
 ArgName, 1155
 ASin, 1158
 ASinDnum, 1159
 Assignment
 =, 41
 ATan, 1160
 ATan2, 1162
 ATan2Dnum, 1163
 ATanDnum, 1161

B

BitAnd, 1164
 BitAndDnum, 1166
 BitCheck, 1168
 BitCheckDnum, 1170
 BitClear, 43
 BitLSh, 1172
 BitLShDnum, 1174
 BitNeg, 1176
 BitNegDnum, 1178
 BitOr, 1180
 BitOrDnum, 1182
 BitRSh, 1184
 BitRShDnum, 1186
 BitSet, 46
 BitXOr, 1188
 BitXOrDnum, 1190
 BookErrNo, 49
 bool, 1600
 Break, 51
 btnres, 1601
 busstate, 1603
 buttontdata, 1604
 byte, 1606
 ByteToStr, 1192

C

CalcJointT, 1194
 CalcRobT, 1198
 CalcRotAxFrameZ, 1200
 CalcRotAxisFrame, 1205
 CallByVar, 52
 cameradev, 1607
 camerastatus, 1608
 cameratarget, 1610
 CamFlush, 54
 CamGetExposure, 1209

CamGetLoadedJob, 1211
 CamGetMode, 1213
 CamGetName, 1214
 CamGetParameter, 55
 CamGetResult, 57
 CamLoadJob, 59
 CamNumberOfResults, 1215
 CamReqImage, 61
 CamSetExposure, 63
 CamSetParameter, 65
 CamSetProgramMode, 67
 CamSetRunMode, 68
 CamStartLoadJob, 69
 CamStartSetParameter, 71
 CamWaitLoadJob, 74
 CamWaitSetParameter, 76
 CancelLoad, 78
 capaptrreferencedata, 1612
 CapAPTrSetup, 80
 CapAPTrSetupAI, 83
 CapAPTrSetupAO, 86
 CapAPTrSetupPERS, 89
 CapC, 92
 CapCondSetDO, 103
 capdata, 1614
 CapEquiDist, 105
 CapGetFailSigs, 1217
 CapL, 107
 caplatrackdata, 1618
 CapLATrSetup, 117
 CapNoProcess, 122
 CapRefresh, 124
 CAPSetStopMode, 126
 capspeeddata, 1622
 capstopmode, 1624
 captrackdata, 1625
 capweavedata, 1628
 CapWeaveSync, 127
 CASE, 858
 CDate, 1219
 cfgdomain, 1635
 CheckProgRef, 130
 CirPathMode, 132
 CJointT, 1220
 Clear, 138
 ClearIOBuff, 139
 ClearPath, 141
 ClearRawBytes, 145
 ClkRead, 1222
 ClkReset, 147
 ClkStart, 148
 ClkStop, 150
 clock, 1636
 Close, 151
 CloseDir, 152
 comment, 153
 CompactIF, 154
 confdata, 1637
 ConfJ, 155
 ConfL, 157
 CONNECT, 160
 ContactL, 162
 CopyFile, 167
 CopyRawBytes, 169
 CornerPathWarning, 171
 CorrClear, 173

CorrCon, 174
corrdescr, 1644
CorrDiscon, 179
CorrRead, 1224
CorrWrite, 180
Cos, 1225
CosDnum, 1226
CPos, 1227
CRobT, 1229
CrossProd, 1232
CSpeedOverride, 1235
CTime, 1237
CTool, 1238
CWObj, 1240

D

datapos, 1646
DeactEventBuffer, 182
DeactUnit, 184
Decr, 186
DecToHex, 1242
DefAccFrame, 1243
DefDFrame, 1246
DefFrame, 1249
Dim, 1252
DInput, 1254
dionum, 1647
dir, 1648
Distance, 1256
DIV, 1258
dnum, 1649
DnumToNum, 1259
DnumToStr, 1261
DotProd, 1263
DOutput, 1265
DropSensor, 188
DropWObj, 189

E

ELSE, 258
ELSEIF, 258
ENDIF, 258
EOF_NUM, 1431
EOffsOff, 190
EOffsOn, 191
EOffsSet, 193
EraseModule, 195
errdomain, 1651
ErrLog, 197
errnum, 1653
ERROR handler, 1817
ErrRaise, 201
errstr, 1661
errtype, 1662
ErrWrite, 205
EulerZYX, 1267
event_type, 1663
EventType, 1269
exec_level, 1664
ExecHandler, 1271
ExecLevel, 1272
EXIT, 207
ExitCycle, 208
Exp, 1273
extjoint, 1665

F

FileSize, 1274
FileTimeDnum, 1277
FitCircle, 210
FitLine, 214, 216, 218
FitPlane, 216
FitSphere, 218
flypointdata, 1667
FOR, 220
FricIdEvaluate, 224
FricIdInit, 223
FricIdSetFricLevels, 227
FSSize, 1280

G

GetAxisDistance, 1283
GetAxisMoveTime, 1285
GetDataVal, 229
GetGroupSignalInfo, 232
GetJointData, 234
GetMaxNumberOfCyclicBool, 1287
GetMecUnitName, 1288
GetModalPayloadMode, 1289
GetMotorTorque, 1290
GetNextCyclicBool, 1293
GetNextMechUnit, 1295
GetNextOption, 1298
GetNextSym, 1299
GetNumberOfCyclicBool, 1301
GetServiceInfo, 1302
GetSignalOrigin, 1304
GetSysData, 236
GetSysInfo, 1306
GetTaskName, 1309
GetTime, 1311
GetTorqueMargin, 1313
GetTrapData, 239
GetTSPStatus, 1315
GetUASUserName, 1317
GInput, 1319
GInputDnum, 1321
GOTO, 241
GOutput, 1324
GOutputDnum, 1326
GripLoad, 243

H

handler_type, 1670
HexToDec, 1329
HollowWristReset, 245

I

I/O interrupt routines, 1823
ICap, 247
icondata, 1671
IDelete, 252
identno, 1673
IDisable, 253
IEnable, 254
IError, 255
IF, 258
Incr, 260
IndAMove, 262
IndCMove, 266
IndDMove, 270
IndInpos, 1330
IndReset, 273

- IndRMove, 278
 - IndSpeed, 1332
 - InitSuperv, 282
 - intnum, 1675
 - InvertDO, 283
 - IOBusStart, 285
 - IOBusState, 286
 - iodev, 1677
 - IODisable, 289
 - IOEnable, 292
 - IOEventMessage, 295
 - iounit_state, 1678
 - IOUnitState, 1334
 - IPathPos, 297
 - IPers, 299
 - IRMQMessage, 301
 - IsBrakeCheckActive, 1337
 - IsCollFree, 1338
 - IsCyclicBool, 1340
 - IsFile, 1343
 - ISignalAI, 305
 - ISignalAO, 315
 - ISignalDI, 319
 - ISignalDO, 322
 - ISignalGI, 325
 - ISignalGO, 328
 - IsLeadThrough, 1347
 - ISleep, 331
 - IsMechUnitActive, 1349
 - IsPers, 1350
 - IsStopMoveAct, 1351
 - IsStopStateEvent, 1353
 - IsSyncMoveOn, 1355
 - IsSysId, 1357
 - IsVar, 1358
 - ITimer, 333
 - IVarValue, 336
 - IWatch, 339
- J**
- jointtarget, 1679
- L**
- label, 341
 - listitem, 1681
 - Load, 342
 - loaddata, 1682
 - LoadId, 347
 - loadidnum, 1688
 - loadsession, 1689
- M**
- MakeDir, 353
 - ManLoadIdProc, 354
 - MatrixAdd, 358
 - MatrixInverse, 361
 - MatrixMult, 364
 - MatrixReset, 369
 - MatrixSolve, 371
 - MatrixSolveQR, 374
 - MatrixSub, 376
 - MatrixSVD, 379
 - MatrixTranspose, 382
 - Max, 1359
 - MaxExtLinearSpeed, 1360
 - MaxExtReorientSpeed, 1361
 - MaxRobReorientSpeed, 1362
 - MaxRobSpeed, 1363
 - MechUnitLoad, 385
 - mecunit, 1690
 - Min, 1364
 - MirPos, 1365
 - MOD, 1367
 - ModExist, 1368
 - ModTimeDnum, 1369
 - MotionPlannerNo, 1371
 - MotionProcessModeSet, 390
 - MotionSup, 392
 - motsetdata, 1692
 - MoveAbsJ, 395
 - MoveC, 402
 - MoveCAO, 410
 - MoveCDO, 415
 - MoveCGO, 420
 - MoveCSync, 425
 - MoveExtJ, 430
 - MoveJ, 434
 - MoveJAO, 439
 - MoveJDO, 444
 - MoveJGO, 448
 - MoveJSync, 453
 - MoveL, 458
 - MoveLAO, 464
 - MoveLDO, 469
 - MoveLGO, 473
 - MoveLSync, 478
 - MovePnP, 483
 - MToolRotCalib, 493
 - MToolTCPCalib, 496
- N**
- NonMotionMode, 1373
 - NOrient, 1376
 - NOT, 1375
 - num, 1698
 - NumToDnum, 1378
 - NumToStr, 1379
- O**
- Offs, 1381
 - opcalc, 1700
 - Open, 499
 - OpenDir, 503
 - OpMode, 1383
 - opnum, 1701
 - OR, 1384
 - orient, 1702
 - OrientZYX, 1385
 - ORobT, 1387
- P**
- PackDNHeader, 505
 - PackRawBytes, 508
 - paridnum, 1707
 - ParIdPosVaild, 1389
 - ParIdRobValid, 1392
 - paridvalidnum, 1709
 - PathAccLim, 512
 - PathLengthGet, 1395
 - PathLengthReset, 516
 - PathLengthStart, 518
 - PathLengthStop, 520
 - PathLevel, 1397
 - pathrecid, 1711

PathRecMoveBwd, 522
PathRecMoveFwd, 528
PathRecStart, 531
PathRecStop, 534
PathRecValidBwd, 1399
PathRecValidFwd, 1402
PathResol, 537
PDispOff, 539
PDispOn, 540
PDispSet, 545
PFRestart, 1406
pnpdata, 1713
pos, 1715
pose, 1717
PoseInv, 1407
PoseMult, 1409
PoseVect, 1411
Pow, 1413
PowDnum, 1414
PPMovedInManMode, 1415
Present, 1416
ProcCall, 548
ProcerrRecovery, 550
processtimes, 1718
progdisp, 1719
ProgMemFree, 1418
PrxActivAndStoreRecord, 556
PrxActivRecord, 558
PrxDbgStoreRecord, 560
PrxDeactRecord, 561
PrxGetMaxRecordpos, 1419
PrxResetPos, 562
PrxResetRecords, 563
PrxSetPosOffset, 564
PrxSetRecordSampleTime, 565
PrxSetSyncalarm, 566
PrxStartRecord, 567
PrxStopRecord, 569
PrxStoreRecord, 570
PrxUseFileRecord, 572
PulseDO, 573

R

RAISE, 576
RaiseToUser, 579
Rand, 1420
rawbytes, 1721
RawBytesLen, 1422
ReadAnyBin, 582
ReadBin, 1424
ReadBlock, 584
ReadCfgData, 586
ReadDir, 1426
ReadErrData, 590
ReadMotor, 1429
ReadNum, 1431
ReadRawBytes, 593
ReadStr, 1434
ReadStrBin, 1438
ReadVar, 1440
ReadVarArr, 596
RelTool, 1442
RemainingRetries, 1444
RemoveAllCyclicBool, 598
RemoveCyclicBool, 600
RemoveDir, 602
RemoveFile, 604

RemoveSuperv, 605
RenameFile, 607
Reset, 609
ResetAxisDistance, 611
ResetAxisMoveTime, 613
ResetPPMoved, 615
ResetRetryCount, 616
ResetTorqueMargin, 617
restartblkdata, 1723
restartdata, 1725
RestoPath, 618
RETRY, 620
RETURN, 621
Rewind, 623
RMQEmptyQueue, 624
RMQFindSlot, 626
RMQGetMessage, 628
RMQGetMsgData, 631
RMQGetMsgHeader, 634
RMQGetSlotName, 1445
rmqheader, 1729
rmqmessage, 1731
RMQReadWait, 637
RMQSendMessage, 640
RMQSendWait, 644
rmqslot, 1732
robjoint, 1733
RobName, 1447
RobOS, 1449
robtarg, 1734
Round, 1450
RoundDnum, 1452
RunMode, 1454

S

SafetyControllerGetChecksum, 1456
SafetyControllerGetOpModePinCode, 1457
SafetyControllerGetSWVersion, 1458
SafetyControllerGetUserChecksum, 1459
SafetyControllerSyncRequest, 649
Save, 650
SaveCfgData, 653
SCWrite, 655
SearchC, 658
SearchExtJ, 668
SearchL, 676
SenDevice, 688
sensor, 1738
Sensor Interface, 584
sensorstate, 1740
sensorvardata, 1741
service routines, 1820
Set, 690
SetAllDataVal, 692
SetAO, 694
SetDataSearch, 696
SetDataVal, 701
SetDO, 704
SetGO, 707
SetLeadThrough, 710
SetSysData, 713
SetupCyclicBool, 715
SetupSuperv, 718
shapedata, 1743
SiClose, 724
SiConnect, 721
SiGetCyclic, 726

signalorigin, 1745
 signalxx, 1747
 SimCollision, 728
 Sin, 1460
 SinDnum, 1461
 SingArea, 729
 SiSetCyclic, 732
 SkipWarn, 734
 SocketAccept, 735
 SocketBind, 738
 SocketClose, 740
 SocketConnect, 742
 SocketCreate, 745
 socketdev, 1749
 SocketGetStatus, 1462
 SocketListen, 747
 SocketPeek, 1465
 SocketReceive, 749
 SocketReceiveFrom, 754
 SocketSend, 759
 SocketSendTo, 763
 socketstatus, 1750
 SoftAct, 767
 SoftDeact, 769
 SoftElbow, 770
 speeddata, 1751
 SpeedLimAxis, 772
 SpeedLimCheckPoint, 776
 SpeedRefresh, 781
 SpyStart, 784
 SpyStop, 786
 Sqrt, 1467
 SqrtDnum, 1468
 StartLoad, 787
 StartMove, 791
 StartMoveRetry, 794
 STCalcForce, 1469
 STCalcTorque, 1471
 STCalib, 797
 STClose, 801
 StepBwdPath, 804
 STIndGun, 23, 806
 STIndGunReset, 23, 808
 STIsCalib, 1473
 STIsClosed, 1475
 STIsIndGun, 1477
 STIsOpen, 1478
 SToolRotCalib, 809
 SToolTCPCalib, 812
 Stop, 815
 STOpen, 818
 StopMove, 820
 StopMoveReset, 824
 stoppointdata, 1755
 StorePath, 826
 StrDigCalc, 1480
 StrDigCmp, 1483
 StrFind, 1485
 StrFormat, 1487
 string, 1761
 stringdig, 1763
 StrLen, 1489
 StrMap, 1490
 StrMatch, 1492
 StrMemb, 1494
 StrOrder, 1496
 StrPart, 1498
 StrToByte, 1500
 StrToVal, 1502
 STTune, 828
 STTuneReset, 832
 supervtimeouts, 1764
 SupSyncSensorOff, 833
 SupSyncSensorOn, 834
 switch, 1766
 symnum, 1767
 syncident, 1768
 SyncMoveOff, 836
 SyncMoveOn, 842
 SyncMoveResume, 848
 SyncMoveSuspend, 850
 SyncMoveUndo, 852
 SyncToSensor, 854
 system data, 1769
 SystemStopAction, 856

T
 Tan, 1504
 TanDnum, 1505
 taskid, 1771
 TasksActive, 1510
 TasksExecuting, 1512
 TaskRunMec, 1506
 TaskRunRob, 1507
 tasks, 1772
 TasksInSync, 1508
 TEST, 858
 TestAndSet, 1514
 TestDI, 1517
 testsignal, 1774
 TestSignDefine, 860
 TestSignRead, 1519
 TestSignReset, 862
 TextGet, 1521
 TextTabFreeToUse, 1524
 TextTabGet, 1526
 TextTabInstall, 863
 tooldata, 1776
 TPErase, 865
 tpnum, 1782
 TPReadDnum, 866
 TPReadFK, 870
 TPReadNum, 875
 TPShow, 879
 TPWrite, 880
 trapdata, 1783
 trap routines, 1826
 TRAP routines, 1826
 TriggAbsJ, 883
 TriggC, 891
 TriggCheckIO, 900
 triggdata, 1785
 TriggDataCopy, 906
 TriggDataReset, 908
 TriggDataValid, 1528
 TriggEquip, 910
 TriggInt, 916
 TriggIO, 921
 triggios, 1786
 triggiosdnum, 1789
 TriggJ, 927
 TriggJIOs, 943
 TriggL, 935

TriggLIOs, 950
triggmode, 1791
TriggRampAO, 958
TriggSpeed, 965
TriggStopProc, 975
triggstrgo, 1794
Trunc, 1530
TruncDnum, 1532
TryInt, 981
TRYNEXT, 983
tsp_status, 1797
TuneReset, 984
TuneServo, 985
tunetype, 1799
Type, 1534

U

UIAlphaEntry, 1536
UIClientExist, 1543
UIDnumEntry, 1544
UIDnumTune, 1551
UIListView, 1558
UIMessageBox, 1567
UIMsgBox, 992
UIMsgWrite, 1001
UIMsgWriteAbort, 1005
UINumEntry, 1576
UINumTune, 1583
UIShow, 1006
uishownum, 1800
UnLoad, 1010
UnpackRawBytes, 1013

V

ValidIO, 1590
ValToStr, 1592
VectMagn, 1594
VelSet, 1017

W

WaitAI, 1019
WaitAO, 1026
WaitDI, 1033

WaitDO, 1039
WaitGI, 1045
WaitGO, 1053
WaitLoad, 1061
WaitRob, 1065
WaitSensor, 1067
WaitSyncTask, 1070
WaitTestAndSet, 1074
WaitTime, 1077
WaitUntil, 1079
WaitWObj, 1087
WarmStart, 1090
weavestartdata, 1801
WHILE, 1091
wobjdata, 1803
WorldAcLim, 1093
Write, 1095
WriteAnyBin, 1098
WriteBin, 1100
WriteBlock, 1102
WriteCfgData, 1104
WriteRawBytes, 1108
WriteStrBin, 1110
WriteVar, 1112
WriteVarArr, 1114
WZBoxDef, 1116
WZCylDef, 1118
WZDisable, 1121
WZDOSet, 1123
WZEnable, 1127
WZFree, 1129
WZHomeJointDef, 1131
WZLimJointDef, 1134
WZLimSup, 1138
WZSphDef, 1141
wzstationary, 1807
wztemporary, 1809

X

XOR, 1596

Z

zonedata, 1811



ABB AB

Robotics & Discrete Automation

S-721 68 VÄSTERÅS, Sweden

Telephone +46 10-732 50 00

ABB AS

Robotics & Discrete Automation

Nordlysvegen 7, N-4340 BRYNE, Norway

Box 265, N-4349 BRYNE, Norway

Telephone: +47 22 87 2000

ABB Engineering (Shanghai) Ltd.

Robotics & Discrete Automation

No. 4528 Kangxin Highway

PuDong New District

SHANGHAI 201319, China

Telephone: +86 21 6105 6666

ABB Inc.

Robotics & Discrete Automation

1250 Brown Road

Auburn Hills, MI 48326

USA

Telephone: +1 248 391 9000

abb.com/robotics